

VDE INSULATED TOOLS

When working on electrical installations or hybrid and electric vehicles safety at work is the top priority. With insulated tools from GEDORE, you are on the safe side.

All VDE safety tools made by GEDORE - from spanners, screwdrivers and pliers to torque wrenches - are manufactured in such a way that they reliably protect the user from electrical shock when used as intended. To achieve this, GEDORE performs every single step, right down to the 100% testing of the electrical insulation properties on the 10,000 V high-voltage test facility.

In addition, all VDE tools meet the DIN-ISO requirements with regard to their properties such as hardness and torque.

GEDORE is not satisfied with just the standard. That is why the tools have intelligent additional functions such as the Check-Tool insulation or the ultra-small blade diameter of the SLIM DRIVE screwdrivers.



HOW DO I RECOGNISE SAFE INSULATED TOOLS?

- Only tools with all test marks are considered to be insulated
- Additionally marked with the name of the manufacturer, model or type designation and year of manufacture



- Tools marked with the double triangle are individually tested
- Testing at 10,000 V AC based on EN 60900/IEC 60900

1000 V

- VDE insulation: insulated up to 1000 V



- Testing performed by VDE Test Institute
- Compliance with tool and safety standards guaranteed
- Tools meet the requirements of the German equipment safety law



- Tool complies with the Equipment and Product Safety Act (GSPG) according to testing and certification office

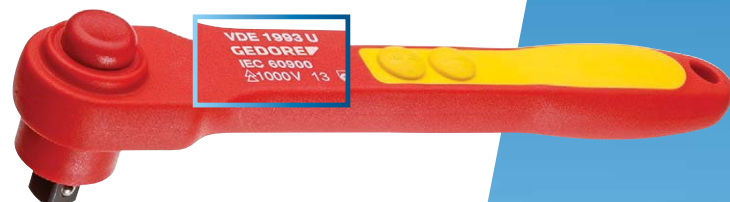

SAFE INSULATED



SAFE UP TO 1000 VOLT

- VDE insulation: insulated up to 1000 V according to EN 60900/IEC 60900
- Safe working under electrical voltage
- Up to AC 1000 V (alternating voltage)
- Up to DC 1500 V (direct voltage)

VDE CHECK-TOOL INSULATION

- All GEDORE VDE soft-plastic insulated safety tools have the Check-Tool insulation.
- The two-colour multi-layer insulation - red on the outside, yellow on the inside - complies with the BGV A3 (VBG-4) regulation.
- The tool must not show any discernable damage.
- If yellow is visible, it is high time to dispose of the tool



The two-ply
Check-Tool
insulation

Insulated tools

VDE 2 E

VDE Single ended ring spanner deep offset



- > Vanadium steel 31CrV3
- > protective insulation up to 1000 V, according to EN 60900/IEC 60900, 2-fold Check-Tool insulation

Code	No.		↳ mm ▶	Code	No.		↳ mm ▶
6035890	VDE 2E 8	8	170	6036780	VDE 2 E 17	17	220
6035970	VDE 2E 9	9	170	6036860	VDE 2 E 19	19	240
6036000	VDE 2 E 10	10	170	6036940	VDE 2 E 22	22	260
6036190	VDE 2 E 11	11	180	6037080	VDE 2 E 24	24	280
6036270	VDE 2 E 12	12	190	6037160	VDE 2 E 27	27	295
6036350	VDE 2 E 13	13	190	6037240	VDE 2 E 30	30	310
6036430	VDE 2 E 14	14	210	6037320	VDE 2 E 32	32	330
6036510	VDE 2 E 15	15	215				

VDE 894

VDE Single open ended spanner



- > Vanadium steel 31CrV3
- > protective insulation up to 1000 V, according to EN 60900/IEC 60900, 2-fold Check-Tool insulation
- > Jaw set at 15°

Code	No.		↳ mm ▶	Code	No.		↳ mm ▶
6572040	VDE 894 9	9	105	6572980	VDE 894 17	17	160
6572120	VDE 894 10	10	105	6573010	VDE 894 19	19	175
6572200	VDE 894 11	11	115	6573280	VDE 894 22	22	200
6572390	VDE 894 12	12	125	6573360	VDE 894 24	24	220
6572470	VDE 894 13	13	135	6573440	VDE 894 27	27	245
6572550	VDE 894 14	14	145	6573520	VDE 894 30	30	265
6572630	VDE 894 15	15	150	6574920	VDE 894 32	32	280
6572710	VDE 894 16	16	155				

V 60 CP

Single open ended spanner adjustable, 1000 V



- > Immersion Insulated
- > piece tested, protective insulation up to 1000 V

Code	No.	Size "	mm	Code	No.	Size "	mm
2179040	V 60 CP 6	6	20	2179067	V 60 CP 10	10	30
2179059	V 60 CP 8	8	25	2179075	V 60 CP 12	12	36

VDE 2133

VDE Socket wrench with 3C-handle



- > Ergonomic 3-component handle Power-Grip³ for maximum power with minimum effort
- > Insulated up to 1000 V, according to EN 60900/IEC 60900
- > hanging hole on handle for space-saving storage

Code	No.			Head-Ø	Ø		
1747045	VDE 2133 3	3	125	225	9	8,9	0,109
1747053	VDE 2133 4	4	125	225	10	8,9	0,111
1747061	VDE 2133 5	5	125	225	11	8,9	0,112
1747088	VDE 2133 6	6	125	225	12	8,9	0,114
1747096	VDE 2133 7	7	125	235	14	9,9	0,152
1747118	VDE 2133 8	8	125	235	15	9,9	0,154
1747126	VDE 2133 9	9	125	235	16	9,9	0,154
1747134	VDE 2133 10	10	125	235	17	9,9	0,161
1747142	VDE 2133 11	11	125	254	19	10,9	0,193
1747150	VDE 2133 12	12	125	245	20	10,9	0,196
1747169	VDE 2133 13	13	125	245	21	10,9	0,199
1747177	VDE 2133 14	14	125	245	22	10,9	0,198
1747185	VDE 2133 17	17	125	245	26	10,9	0,222

VDE 4508

VDE Torque wrench 5-50 N·m



- > Release system triggers a tactile and audible signal
- > Recalibration without destroying the insulation
- > Fine toothed ratchet with square drive as per DIN 3120, ISO 1174

- > Safety button to protect against accidental release of the insert
- > Insulated up to 1000 V, according to EN 60900/IEC 60900

Code	No.	"	mm	N·m		↳ mm ▶	
3125335	VDE 4508-02	3/8"	10	5-25	1	319	0,714
3079066	VDE 4508-05	1/2"	12,5	10-50	2,5	369	0,825

VDE 30

VDE-Socket 3/8"
hexagon

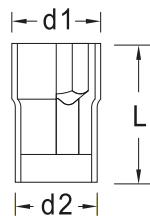

- > With square drive as per DIN 3120 - C 10, ISO 1174
- > protective insulation up to 1000 V, according to EN 60900/IEC 60900, 2-fold Check-Tool insulation
- > 16 - 18 mm insulation overhang

Code	No.	mm	L	d1	d2	kg
2946386	VDE 30 6	6	44	13,7	23,0	0,03
2946394	VDE 30 8	8	44	16,1	23,0	0,035
2946408	VDE 30 9	9	44		23,0	0,035
2946416	VDE 30 10	10	44	18,7	23,0	0,035
2946424	VDE 30 11	11	44	20,0	23,0	0,035
2946432	VDE 30 12	12	44	21,2	23,0	0,04
2946440	VDE 30 13	13	44	22,5	23,0	0,04
2946459	VDE 30 14	14	45	23,7	23,0	0,045
2946467	VDE 30 15	15	46	25,0	23,0	0,05
2946475	VDE 30 16	16	46	26,2	23,0	0,06
2946483	VDE 30 17	17	46	27,5	23,0	0,065
2946491	VDE 30 18	18	46	28,7	23,0	0,075
2946505	VDE 30 19	19	46	30,0	23,0	0,075
2946513	VDE 30 20	20	47	31,2	23,0	0,085
2946521	VDE 30 22	22	48	33,7	23,0	0,105

VDE INX 30

VDE Screwdriver bit
socket 3/8"
for multi-point screws
XZN



- > With square drive as per DIN 3120 - C 10, ISO 1174
- > protective insulation up to 1000 V, according to EN 60900/IEC 60900, 2-fold Check-Tool insulation

Code	No.		mm	kg
2946564	VDE INX 30 8	M8	120	0,08
2946572	VDE INX 30 10	M10	120	0,11
2946580	VDE INX 30 12	M12	120	0,14

VDE 3090

VDE-Extension 3/8"



- > For hand-operated sockets with square drive as per DIN 3120, ISO 1174
- > protective insulation up to 1000 V, according to EN 60900/IEC 60900, 2-fold Check-Tool insulation
- > 16 - 18 mm insulation overhang

Code	No.	"	mm	mm	kg
2946548	VDE 3090-3	3/8"	10	75	0,097
2946556	VDE 3090-6	3/8"	10	150	0,115

VDE 3093 U

VDE Reversible ratchet 3/8"
with push-button release



- > Absolutely secure hold of the attachments due to push-button locking with ball in the square drive
- > Direction changed by 2 push-buttons, marked R and L, on the shaft
- > Square drive according to DIN 3120 - A 10, ISO 1174

- > Insulated up to 1000 V, according to EN 60900/IEC 60900
- > Sleeve insulation

Code	No.	"	mm	°	mm	kg
2946599	VDE 3093 U	3/8"	10	8,2	185	0,215

Insulated tools

VDE 19
VDE-Socket 1/2"

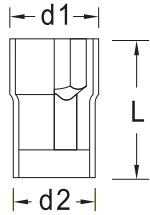

- > With square drive as per DIN 3120 - C 12,5, ISO 1174
- > protective insulation up to 1000 V, according to EN 60900/IEC 60900, 2-fold Check-Tool insulation
- > 16 - 18 mm insulation overhang

Code	No.	mm	L	d1	d2	kg
6122510	VDE 19 10	10	54	19,5	27,0	0,07
6122780	VDE 19 11	11	54	20,7	27,0	0,067
6122860	VDE 19 12	12	54	22,0	27,0	0,07
6122940	VDE 19 13	13	54	23,2	27,0	0,069
6123080	VDE 19 14	14	54	24,5	27,0	0,073
6123160	VDE 19 15	15	55,5	25,7	27,0	0,088
1439294	VDE 19 16	16	55,5	27,0	27,0	0,086
6123240	VDE 19 17	17	55,5	28,2	27,0	0,084
6123320	VDE 19 19	19	56	30,7	27,0	0,092
6123400	VDE 19 22	22	57,5	34,5	27,0	0,121
6123590	VDE 19 24	24	57,5	37,0	27,0	0,146
6123670	VDE 19 27	27	57,5	40,7	27,0	0,174
6123750	VDE 19 30	30	59	44,5	27,0	0,212
6123830	VDE 19 32	32	60,5	47,0	27,0	0,25

VDE IN 19
VDE Screwdriver bit socket 1/2"
for in-hex screws



- > With square drive as per DIN 3120 - C 12,5, ISO 1174, with ball retaining groove
- > protective insulation up to 1000 V, according to EN 60900/IEC 60900, 2-fold Check-Tool insulation
- > These inserts can only be combined with No. VDE 1989 T, VDE 1991, VDE 1993 U and VDE 4507

Code	No.	mm	mm	d	kg
6124480	VDE IN 19 5	5	106	27	0,083
6124560	VDE IN 19 6	6	106	27	0,095
6124640	VDE IN 19 8	8	106	27	0,109

VDE 1990
VDE Extension 1/2"



- > For hand-operated sockets with square drive as per DIN 3120, ISO 1174
- > protective insulation up to 1000 V, according to EN 60900/IEC 60900, 2-fold Check-Tool insulation
- > Not suited for use with No. VDE IN 19
- > 16 - 18 mm insulation overhang

Code	No.	"	mm	mm	kg
6124050	VDE 1990-5	1/2"	12,5	125	0,213
6124130	VDE 1990-10	1/2"	12,5	250	0,411

VDE 1991
VDE Extension 1/2"
with hollow shaft



- > With hollow shaft, especially suitable for screwdriver bit sockets VDE IN 19
- > Max. torque 370 N-m
- > protective insulation up to 1000 V, according to EN 60900/IEC 60900, 2-fold Check-Tool insulation

Code	No.	"	mm	mm	kg
1507516	VDE 1991	1/2"	12,5	125	0,204

VDE 1988

VDE T-handle
for 1/2" VDE tools



- > With screw locking, not suited for use with VDE IN 19
- > protective insulation up to 1000 V, according to EN 60900/IEC 60900, 2-fold Check-Tool insulation

Code	No.	"	mm	mm	kg
6124210	VDE 1988	1/2"	12,5	200	0,455
6124720	VDE 1989 T	1/2"	12,5	200	0,355

VDE 1993 U

VDE Reversible ratchet 1/2"
with push-button release



- > secure holding of the attachments due to push-button locking with ball in the square drive
- > Direction changed by 2 push-buttons, marked R and L, on the shaft
- > Square drive according to DIN 3120 - A 12.5, ISO 1174
- > Insulated up to 1000 V, according to EN 60900/IEC 60900

Code	No.	"	mm	°	mm	kg
6123910	VDE 1993 U	1/2"	12,5	10	270	0,546

VDE 42

VDE Hexagon allen key
for in-hex screws

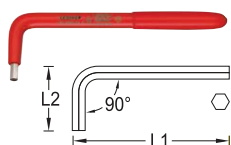

- > Acc. to DIN ISO 2936
- > Especially suitable for cable branch clamping rings
- > piece tested, protective insulation up to 1000 V

Code	No.	mm	L1	L2	kg
2324849	V 42 3	3	130	23,5	0,02
2324857	V 42 4	4	120	40	0,025
2324865	V 42 5	5	140	48	0,045
2324873	V 42 6	6	140	48	0,06
2324881	V 42 8	8	150	51	0,11
2324903	V 42 10	10	220	51	0,23
2324911	V 42 12	12	260	61,5	0,35

VDE 42 T

Hexagon allen key
with T-handle
for in-hex screws



- > piece tested, protective insulation up to 1000 V
- > With Check-Tool insulation

Code	No.	mm	mm	mm	kg
2661225	V 42 T 4	4	160	x	0,145
2661233	V 42 T 5	5	160	x	0,25
2661241	V 42 T 6	6	160	x	0,25
2661268	V 42 T 8	8	160	x	0,26
2661276	V 42 T 10	10	200	-	0,39
2661284	V 42 T 11	11	200	-	0,4
2661292	V 42 T 12	12	200	-	0,42

VDE 2170

VDE Screwdriver
for slotted head screws



- > individually tested, insulated up to 1000 V, according to EN 60900/IEC 60900, fully insulated blade
- > Tip as per DIN ISO 2380-1 Form B
- > Ergonomic 3-component handle Power-Grip³ for maximum power with minimum effort
- > Type of drive marked at end of the handle
- > hanging hole on handle for space-saving storage

Code	No.	mm	mm	mm	kg
1612220	VDE 2170 2,5	2,5	75	160	0,038
1612239	VDE 2170 3	3,0	100	185	0,042
1612247	VDE 2170 3,5	3,5	100	185	0,055
1612255	VDE 2170 4	4,0	100	185	0,058
1612271	VDE 2170 5,5	5,5	125	225	0,095
1612298	VDE 2170 6,5	6,5	150	260	0,134
1612301	VDE 2170 8	8,0	175	295	0,158

SLIM DRIVE

Easily gets where others get stuck

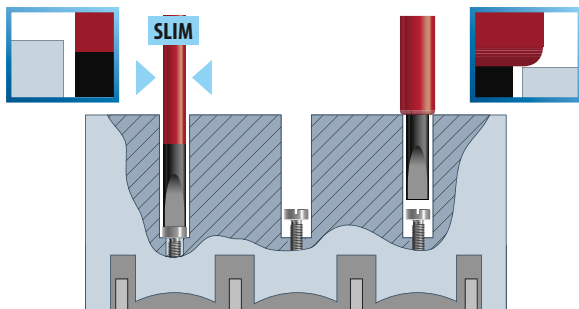



- Ultra-small blade diameter yet with full mechanical and electrical safety
- No problems in reaching screws deeply embedded in screw shafts
- VDE insulation up to 1000 V, acc. to EN 60900/IEC 60900, fully insulated blade
- 3-component handles Power-Grip³ with hanging hole
- Ergonomic handle design enables precise and fatigue-free working
- Positive-fit joint of handle and blade for optimum transmission of force
- Type of drive marked at end of the handle
- Blade from GEDORE molybdenum-vanadium-Plus tempered steel

VDE 2172
VDE-Screwdriver SLIM DRIVE
for slotted head screws



- > individually tested, insulated up to 1000 V, according to EN 60900/IEC 60900, fully insulated blade
- > Ergonomic 3-component handle Power-Grip³ for maximum power with minimum effort
- > Type of drive marked at end of the handle
- > Ultra-small blade diameter yet with full mechanical and electrical safety
- > hanging hole on handle for space-saving storage

Code	No.	⊖			
2824736	VDE 2172 3,5	3,5	100	185	0,055
2824744	VDE 2172 4	4,0	100	185	0,055
2824752	VDE 2172 5,5	5,5	125	225	0,1
2824760	VDE 2172 6,5	6,5	150	260	0,14

V 2160 MS PH 2
Screwdriver MaVo
for cross-head screws PH





- > Non-contact voltage finder and built-in magnetic field tester
- > Voltage fields are displayed in red and magnetic fields in green
- > 3-component handle Power-Grip³
- > piece tested, protective insulation up to 1000 V

Code	No.	⊕ PH			
2824434	V 2160 MS PH 2	2	100	210	0,14

VDE 2160 PH
VDE Screwdriver
for cross-head screws PH



- > individually tested, insulated up to 1000 V, according to EN 60900/IEC 60900, fully insulated blade
- > Tip as per DIN ISO 8764-1 PH
- > Ergonomic 3-component handle Power-Grip³ for maximum power with minimum effort
- > Type of drive marked at end of the handle

Code	No.	⊕ PH			
1612107	VDE 2160 PH 0	0	60	145	0,039
1612115	VDE 2160 PH 1	1	80	180	0,082
1612123	VDE 2160 PH 2	2	100	210	0,119
1612131	VDE 2160 PH 3	3	150	270	0,188
1612158	VDE 2160 PH 4	4	200	320	0,269

VDE 2160 PZ

VDE Screwdriver
for cross-head screws Pozzi PZ



- > individually tested, insulated up to 1000 V, according to EN 60900/IEC 60900, fully insulated blade
- > Tip as per DIN ISO 8764-1 PZ

- > Ergonomic 3-component handle Power-Grip³ for maximum power with minimum effort
- > Type of drive marked at end of the handle

Code	No.	PZ			
1612166	VDE 2160 PZ 0	0	60	145	0,038
1612182	VDE 2160 PZ 1	1	80	180	0,082
1612190	VDE 2160 PZ 2	2	100	210	0,12
1612204	VDE 2160 PZ 3	3	150	270	0,188
1612212	VDE 2160 PZ 4	4	200	320	0,27

VDE 2162 PH

VDE-Screwdriver SLIM DRIVE
for cross-head screws PH



- > individually tested, insulated up to 1000 V, according to EN 60900/IEC 60900, fully insulated blade
- > Ergonomic 3-component handle Power-Grip³ for maximum power with minimum effort

- > Type of drive marked at end of the handle
- > Ultra-small blade diameter yet with full mechanical and electrical safety
- > hanging hole on handle for space-saving storage

Code	No.	⊕ PH			
2824442	VDE 2162 PH 1	1	80	180	0,1
2824450	VDE 2162 PH 2	2	100	210	0,14

VDE 2162 PZ

VDE-Screwdriver SLIM DRIVE
for cross-head screws Pozzi PZ



- > individually tested, insulated up to 1000 V, according to EN 60900/IEC 60900, fully insulated blade
- > Ergonomic 3-component handle Power-Grip³ for maximum power with minimum effort

- > Type of drive marked at end of the handle
- > Ultra-small blade diameter yet with full mechanical and electrical safety
- > hanging hole on handle for space-saving storage

Code	No.	PZ			
2824469	VDE 2162 PZ 1	1	80	180	0,1
2824477	VDE 2162 PZ 2	2	100	210	0,14

VDE 2162-2172 PH-02

VDE Screwdriver set SLIM DRIVE
2 pieces



- > For slotted and cross-head screws PH
- > Ultra-small blade diameter yet with full mechanical and electrical safety
- > Insulated up to 1000 V, according to EN 60900/IEC 60900, fully insulated blade

- > Ergonomic 3-component handle Power-Grip³ for maximum power with minimum effort
- > hanging hole on handle for space-saving storage

Code	No.	Contents	Pieces	
2928736	VDE 2162-2172 PH-02	VDE 21723,5 VDE 2162 PH2	2	0,195

Insulated tools

VDE 2162-2172 PZ-06

VDE Screwdriver set SLIM DRIVE

6 pieces

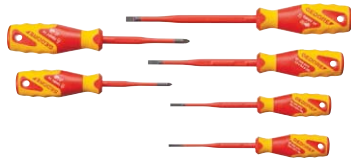

- > For slotted and cross-head screws PZ
- > Ultra-small blade diameter yet with full mechanical and electrical safety
- > Insulated up to 1000 V, according to EN 60900/IEC 60900, fully insulated blade

- > Ergonomic 3-component handle Power-Grip³ for maximum power with minimum effort

Code	No.	Contents	Pieces	
2928728	VDE 2162-2172 PZ-06	VDE 21723,5 4 5,5 6,5 VDE 2162 PZ1 2	6	0,59

VDE 2162-2172 PM-06

VDE Screwdriver set SLIM DRIVE

6 pieces

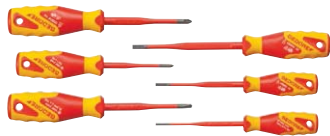

- > For slotted, cross-head PH and plus-minus screws
- > Ultra-small blade diameter yet with full mechanical and electrical safety
- > Insulated up to 1000 V, according to EN 60900/IEC 60900, fully insulated blade

- > Ergonomic 3-component handle Power-Grip³ for maximum power with minimum effort
- > hanging hole on handle for space-saving storage

Code	No.	Contents	Pieces	
2928701	VDE 2162-2172 PM-06	VDE 21723,5 4 5,5 VDE 2162 PH1 2 VDE 2164 SL/PH2	6	0,59

VDE 2164

VDE-Screwdriver SLIM DRIVE PlusMinus for Plus-Minus screws



- > individually tested, insulated up to 1000 V, according to EN 60900/IEC 60900, fully insulated blade
- > Ergonomic 3-component handle Power-Grip³ for maximum power with minimum effort

- > Type of drive marked at end of the handle
- > Ultra-small blade diameter yet with full mechanical and electrical safety
- > hanging hole on handle for space-saving storage

Code	No.	⊕ PH			
2824817	VDE 2164 SL/PH1	1	80	180	0,1
2824825	VDE 2164 SL/PH2	2	100	210	0,14

VDE 2163 K

VDE Screwdriver

for in-hex screws, ball end



- > individually tested, insulated up to 1000 V, according to EN 60900/IEC 60900, fully insulated blade
- > Ergonomic 3-component handle Power-Grip³ for maximum power with minimum effort

- > Type of drive marked at end of the handle
- > Working angle approx. 25° in each direction
- > hanging hole on handle for space-saving storage

Code	No.	⬢			
2824485	VDE 2163 K 2,5	2,5	75	160	0,055
2824493	VDE 2163 K 3	3	75	160	0,055
2824507	VDE 2163 K 4	4	75	160	0,055
2824515	VDE 2163 K 5	5	75	175	0,1
2824523	VDE 2163 K 6	6	100	210	0,14
2824531	VDE 2163 K 8	8	100	220	0,222

VDE 2163 TXVDE Screwdriver
for recessed TX head screws

- > individually tested, insulated up to 1000 V, according to EN 60900/IEC 60900, fully insulated blade
- > Ergonomic 3-component handle Power-Grip³ for maximum power with minimum effort

- > Type of drive marked at end of the handle
- > hanging hole on handle for space-saving storage

Code	No.				Code	No.			
2824558	VDE 2163 TX T5	T5	145	0,055	2824639	VDE 2163 TX T20	T20	180	0,1
2824574	VDE 2163 TX T6	T6	145	0,1	2824647	VDE 2163 TX T25	T25	180	0,1
2824582	VDE 2163 TX T7	T7	145	0,1	2824655	VDE 2163 TX T27	T27	210	0,1
2824590	VDE 2163 TX T8	T8	145	0,1	2824663	VDE 2163 TX T30	T30	210	0,14
2824604	VDE 2163 TX T9	T9	145	0,1	2824671	VDE 2163 TX T40	T40	270	0,14
2824612	VDE 2163 TX T10	T10	145	0,1	2824698	VDE 2163 TX T45	T45	270	0,222
2824620	VDE 2163 TX T15	T15	180	0,1					

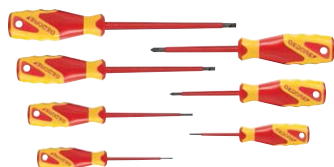
VDE 2170-2160 PH-077VDE Screwdriver set
7 pieces

- > For slotted and cross-head screws PH
- > Insulated up to 1000 V, according to EN 60900/IEC 60900, fully insulated blade

- > Ergonomic 3-component handle Power-Grip³ for maximum power with minimum effort

Code	No.	Contents	Pieces	
1616048	VDE 2170-2160 PH-077	slotted 2,5 4 5,5 6,5 mm PH 0 1 2	7	0,575

VDE 4616

Voltage tester 1000 V



- > Voltage 12 V - 1000 V AC/ DC (LED)
- > Acoustic and optical continuity test up to 100 Ω (buzzer/ yellow LED)
- > Direct display without push button operation (high resistance test)
- > Load connection via push-buttons (low-impedance test)

- > Non-contact phase tester/cable break detector (yellow LED flashing)
- > Protection classification IP65, dust-proof, hose-proof
- > Tested and approved acc. to IEC/EN 61243-3:2015
- > Over voltage category CAT IV 600 V, CAT III 1000 V

Code	No.	
3032744	VDE 4616	0,425

4615

Voltage tester



- > For 220-250 Volt AC
- > Blade nickel-plated, fully insulated blade conforming to DIN VDE 0680-6

- > No. 4615 3 with metal clip and yellow cap

Code	No.				
6699110	4615 3	3,0	60	140	0,022
6699380	4615 3,5	3,5	90	180	0,037

Insulated tools

V 180 Cable shears



> Cuts copper and aluminium cables up to 27 mm Ø, solid 200 mm².

> piece tested, protective insulation up to 1000 V

Code	No.	mm ²	Ø	↳ mm	⚖
6430330	V 180 23	200	27	620	2,125

V 8091 Cable cutter



> For cutting copper and aluminium cables
> piece tested, protective insulation up to 1000 V
> No. V 8091-320: Single-wire cables max. Ø 25 mm (1"), multi-wire cables max. Ø 32 mm (1.1/4")

> No. V 8091-500: Stranded cables max. Ø 52 mm (2.1/32")



Code	No.	↳ mm	⚖
6725130	V 8091-320	280	0,792
6725210	V 8091-500	280	0,999

VDE 183 VDE-Plier wrench



> Adjustable, universal tool for wrenching work, bending, holding, pressing and gripping
> Smooth jaws for gentle gripping of surface-sensitive workpieces (e.g. chrome-plated screw connections, bathroom fittings)
> Function of an open-end ratchet
> 21 setting positions and quick adjustment with automatic engagement function

> Protective insulation up to 1000 V, according to EN 60900/IEC 60900, 2-fold Check-Tool insulation
> DIN ISO 5743/IEC 60900

Code	No.	Size	↳ mm	mm	⚖
3066088	VDE 183 10	10"	268	50	0,665

VDE 8094 VDE Cable shears with VDE dipped insulation



> For cutting multi-core copper and aluminium cables up to Ø 20 mm
> The diameter increases to Ø 25 mm when using rough and finish cuts
> The handle width remains within the range of ergonomic single-hand operation

> Not suitable for steel wire and hard copper
> Protective insulation up to 1000 V, according to EN 60900/IEC 60900
> Immersion insulation: 2-fold Check-Tool insulation

Code	No.	mm ²	Ø	↳ mm	↳ inch	⚖
6725050	VDE 8094	70	20	200	8.1/2	0,423

VDE 8098 VDE Stripping pliers, with VDE dipped insulation



> Opens automatically, with spring and adjusting screw
> V-shaped cutting jaws for stripping the plastic insulation of single- and multi-core conductors
> For wires from 0.8 to 6.0 mm²

> Protective insulation up to 1000 V, according to EN 60900/IEC 60900
> Immersion insulation: 2-fold Check-Tool insulation

Code	No.	L	L3	W3	T1	mm ²	⚖
6708980	VDE 8098-160	160	43,5	18,5	8,5	0,8-6,0	0,217

VDE 8098 H

VDE Stripping pliers,
with VDE insulating sleeves

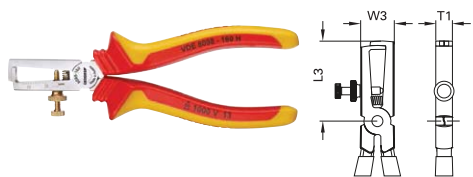

- > Opens automatically, with spring and adjusting screw
- > V-shaped cutting jaws for stripping the plastic insulation of single- and multi-core conductors
- > For wires from 0.8 to 6.0 mm²

- > Protective insulation up to 1000 V, according to EN 60900/IEC 60900
- > Sleeve insulation

Code	No.	L	L3	W3	T1	mm ²	
1552074	VDE 8098-160 H	160	43,5	18,5	8,5	0,8-6,0	0,204

VDE 8099

VDE Stripping pliers STRIP-FIX
with VDE dipped insulation



- > Self-adjusting, for wires 0.5 - 5.0 mm²
- > V-shaped cutting jaws for stripping the plastic insulation of single- and multi-core conductors

- > Protective insulation up to 1000 V, according to EN 60900/IEC 60900
- > Immersion insulation: 2-fold Check-Tool insulation

Code	No.	↳ mm ↲	↳ inch ↲	mm ²	
6709600	VDE 8099-160	160	6.1/2	0,5-5,0	0,226

VDE 8099 H

VDE Stripping pliers STRIP-FIX
with VDE insulating sleeves



- > Self-adjusting, for wires 0.5 - 5.0 mm²
- > V-shaped cutting jaws for stripping the plastic insulation of single- and multi-core conductors

- > Protective insulation up to 1000 V, according to EN 60900/IEC 60900
- > Sleeve insulation

Code	No.	↳ mm ↲	↳ inch ↲	mm ²	
1552082	VDE 8099-160 H	160	6.1/2	0,5-5,0	0,211

VDE 146

VDE Universal pliers
7 settings



- > With safety box joint and protection against blocking
- > Automatic clamping with offset gripping surfaces
- > Protective insulation up to 1000 V, according to EN 60900/IEC 60900

- > Immersion insulation: 2-fold Check-Tool insulation

Code	No.	↳ mm ↲	mm	
6120140	VDE 146 10	250	31	0,485

VDE 8131 AB

VDE Multiple pliers
with VDE insulating sleeves, angled pattern



- > Pliers in VDE design especially adapted to the needs of electricians
- > Cable cutter, cables up to 5x2.5 mm² or Ø 12 mm
- > Stripping blades for wires 1.5 mm² and 2.5 mm²
- > Crimping profile: Crimping of ferrules

- > Serrated gripping surface
- > Curved pliers tip
- > Protective insulation up to 1000 V, according to EN 60900/IEC 60900
- > Sleeve insulation

Code	No.	↳ mm ↲	
2910845	VDE 8131 AB-200 H	200	0,217

Insulated tools

VDE 8250

VDE Heavy duty combination pliers, with VDE dipped insulation

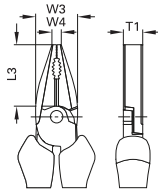

- > Individually tested
- > For round and flat material
- > Extra long blades
- > For all wire types including piano wire, 1.6 mm

- > Protective insulation up to 1000 V, according to EN 60900/IEC 60900
- > Immersion insulation: 2-fold Check-Tool insulation

Code	No.	L	L3	W3	W4	T1	
1429582	VDE 8250-160	160	35	22,8	6,0	10,4	0,236
6720090	VDE 8250-180	180	38,5	25,6	6,5	11,0	0,312
6720250	VDE 8250-200	200	40	27,0	6,0	12,0	0,365
6720330	VDE 8250-225	225	42	27,7	6,0	13,0	0,485

VDE 8250 H

VDE Heavy duty combination pliers, with VDE insulating sleeves

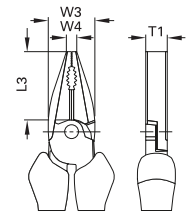

- > Individually tested
- > For round and flat material
- > Extra long blades
- > For all wire types including piano wire, 1.6 mm

- > Protective insulation up to 1000 V, according to EN 60900/IEC 60900
- > Sleeve insulation

Code	No.	L	L3	W3	W4	T1	
1550942	VDE 8250-160 H	160	35	22,8	5,8	10,4	0,228
1550950	VDE 8250-180 H	180	38,5	25,6	6,5	11,0	0,288
1550969	VDE 8250-200 H	200	39,5	27,0	6,5	12,4	0,369

VDE 8314

VDE Side cutter, with VDE dipped insulation

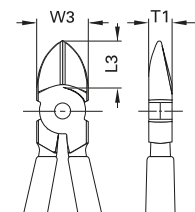

- > Acc. to DIN ISO 5749
- > With slender head, ideal for confined spaces
- > For medium-hard wire 1.6 mm

- > Protective insulation up to 1000 V, according to EN 60900/IEC 60900
- > Immersion insulation: 2-fold Check-Tool insulation

Code	No.	L	L3	W3	T1	Ø	
6743540	VDE 8314-140	140	18,5	18,5	9,5	1,6	0,199
6743620	VDE 8314-160	160	19	22,0	10,0	1,6	0,253

i (VDE) 8314-180

Particularly suitable for electrical installation work

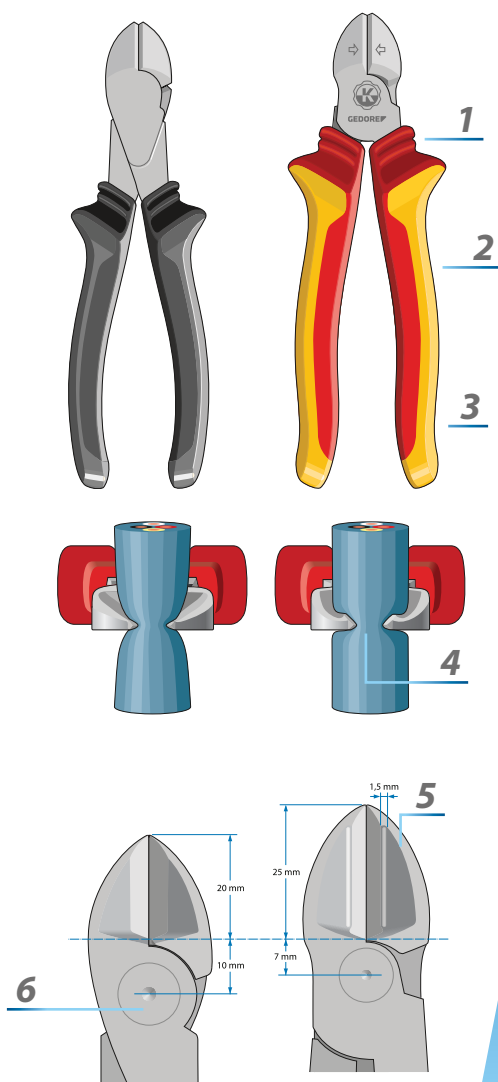



- 1** Max. safety when used under voltages thanks to the long, insulated handle with non-slip mechanism
- 2** Long contoured handle for a heightened transfer of force and improved stable hold particularly with large cable diameters
- 3** Convex handle shape for a high force build-up*
- 4** Longer XL cutting edges than comparable side cutters cables allow cables to be cut from a 0 up to 15 mm (5x2,5 mm²)
- 5** Stepped cutting edges make "cutting" easier and protect the cutting material
- 6** Power side cutter thanks to a marked transfer of the pivot to the cutter

* Crowned surfaces/handles - i.e. which are hardly rounded - prevent unfavourable, punctual peak forces. As a result, the force is evenly spread across your hand.

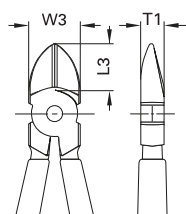
VDE 8314-180 H
VDE Power side cutter
with VDE insulating sleeves



- > With slender head, ideal for confined spaces
- > For medium-hard wire 1.6 mm
- > Protective insulation up to 1000 V, according to EN 60900/IEC 60900

> Sleeve insulation

Code	No.	L	L3	W3	T1	Ø	
2910950	VDE 8314-180 H	185	25	26,0	11,0	1,6	0,297

Insulated tools

VDE 8314 H

VDE Side cutter,
with VDE insulating sleeves

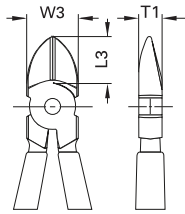

- > With slender head, ideal for confined spaces
- > For medium-hard wire 1.6 mm
- > Protective insulation up to 1000 V, according to EN 60900/IEC 60900

- > Sleeve insulation

Code	No.	L	L3	W3	T1	Ø	
1552155	VDE 8314-140 H	140	18,5	18,5	9,5	1,6	0,177
1552163	VDE 8314-160 H	160	19	22,0	10,0	1,6	0,231

VDE 8315 H

VDE Electricians' side cutter
with VDE insulating sleeves

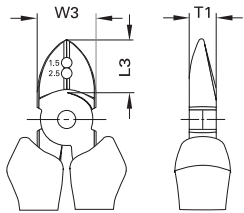

- > Double-function electricians' side cutters: for cutting and stripping wire
- > Stripping holes for solid and stranded conductors with 1.5 mm² and 2.5 mm² conductor cross-section

- > Protective insulation up to 1000 V, according to EN 60900/IEC 60900
- > Sleeve insulation

Code	No.	L	L3	W3	T1	Ø	mm ²	
1742582	VDE 8315-160 H	160	19	22,0	10,0	1,6	1,5 and 2,5 mm ²	0,231

VDE 8316

VDE Power side cutter
with VDE dipped insulation

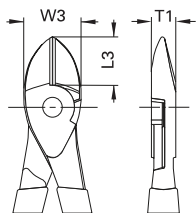

- > For hard wire/piano wire
- > Max. cutting capacity Ø 1,8 - 2,0 mm
- > Protective insulation up to 1000 V, according to EN 60900/IEC 60900

- > Immersion insulation: 2-fold Check-Tool insulation

Code	No.	L	L3	W3	T1	Ø	
1429590	VDE 8316-180	180	22,6	26,0	11,0	1,8	0,285
6742570	VDE 8316-200	200	22	28,0	11,0	2,0	0,341

VDE 8316 H

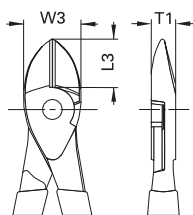
 VDE Power side cutter
with VDE insulating sleeves

- > For hard wire/piano wire
- > Max. cutting capacity \varnothing 1,4 - 2,0 mm
- > Protective insulation up to 1000 V, according to EN 60900/IEC 60900

> Sleeve insulation

Code	No.	L	L3	W3	T1	\varnothing	
1550993	VDE 8316-180 H	180	22,6	26,0	11,0	1,8	0,267
1551000	VDE 8316-200 H	200	22	28,0	11,0	2,0	0,344

VDE 8367

VDE Heavy duty end cutting nippers

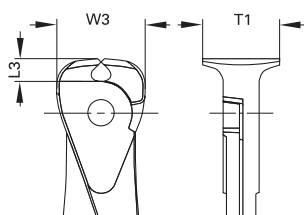

- > High leverage for easier work
- > For hard wire/piano wire 1.6 mm
- > Protective insulation up to 1000 V, according to EN 60900/IEC 60900

> Immersion insulation: 2-fold Check-Tool insulation

Code	No.	L	L3	W3	T1	\varnothing	
2324830	VDE 8367-160	160	6,9	27,0	23,5	1,6	0,22

VDE 8120

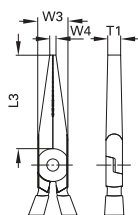
 VDE Flat nose pliers
with VDE dipped insulation

- > With long jaws, serrated gripping faces
- > Protective insulation up to 1000 V, according to EN 60900/IEC 60900

> Immersion insulation: 2-fold Check-Tool insulation

Code	No.	L	L3	W3	W4	T1	
6715330	VDE 8120-160	160	51	16,5	3,4	9,0	0,185

Insulated tools

VDE 8120 H

VDE Flat nose pliers
with VDE insulating sleeves

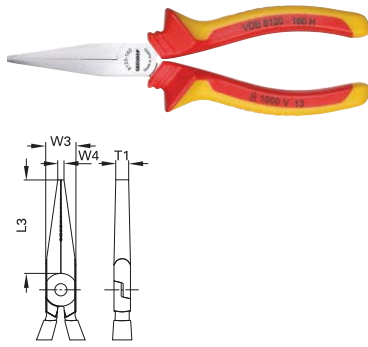

- > With long jaws, serrated gripping faces
- > Protective insulation up to 1000 V, according to EN 60900/IEC 60900

> Sleeve insulation

Code	No.	L	L3	W3	W4	T1	
1552090	VDE 8120-160 H	160	51	16,5	3,4	9,0	0,175

VDE 8122

VDE Round nose pliers
with VDE dipped insulation

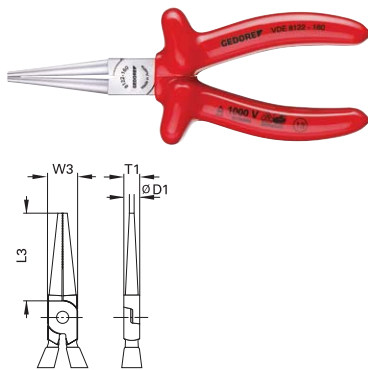

- > With long jaws, serrated gripping faces
- > For gripping and bending
- > Protective insulation up to 1000 V, according to EN 60900/IEC 60900

> Immersion insulation: 2-fold Check-Tool insulation

Code	No.	L	L3	W3	D1	T1	
6717110	VDE 8122-160	160	48	16,5	2,5	8,7	0,17

VDE 8122 H

VDE Round nose pliers
with VDE insulating sleeves

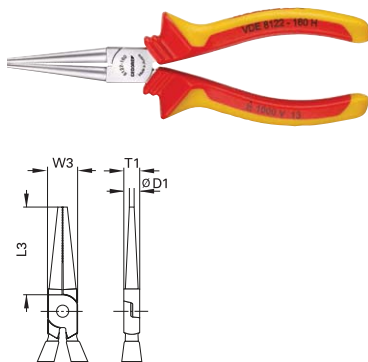

- > With long jaws, serrated gripping faces
- > For gripping and bending
- > Protective insulation up to 1000 V, according to EN 60900/IEC 60900

> Sleeve insulation

Code	No.	L	L3	W3	D1	T1	
1552104	VDE 8122-160 H	160	48	16,5	2,5	8,7	0,154

VDE 8132

VDE Telephone pliers
with immersion insulation, straight

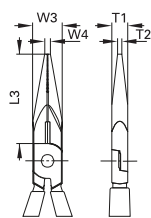

- > Long, flat-round jaws, straight gripping faces, serrated
- > For holding, gripping, bending and cutting

- > Protective insulation up to 1000 V, according to EN 60900/IEC 60900
- > Immersion insulation: 2-fold Check-Tool insulation

Code	No.	L	L3	W3	W4	T1	T2	
6721570	VDE 8132-160	160	50	16,5	3,2	9,0	2,5	0,193
6721650	VDE 8132-200	200	75,7	3,7	3,7	9,5	2,8	0,248

VDE 8132 H

VDE Telephone pliers
with sheath insulation, straight

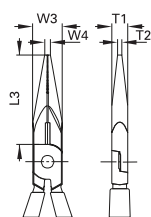

- > Long, flat-round jaws, straight gripping faces, serrated
- > For holding, gripping, bending and cutting

- > Protective insulation up to 1000 V, according to EN 60900/IEC 60900
- > Sleeve insulation

Code	No.	L	L3	W3	W4	T1	T2	
1552112	VDE 8132-160 H	160	50	16,5	3,2	9,0	2,5	0,164
1552120	VDE 8132-200 H	200	75,7	18,5	3,7	9,5	2,8	0,235

VDE 8132 AB

VDE Telephone pliers
with immersion insulation, angled

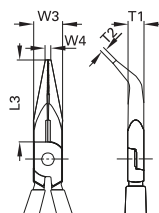

- > Long, flat-round jaws, straight gripping faces, serrated
- > tips 45° angled

- > Protective insulation up to 1000 V, according to EN 60900/IEC 60900
- > Immersion insulation: 2-fold Check-Tool insulation

Code	No.	L	L3	W3	W4	T1	T2	
6721730	VDE 8132 AB-160	160	46	16,5	3,2	9,0	2,5	0,177
6721810	VDE 8132 AB-200	200	70,5	18,5	3,7	9,5	2,8	0,252

Insulated tools

VDE 8132 AB H

VDE Telephone pliers
with VDE insulating sleeves, angled pattern

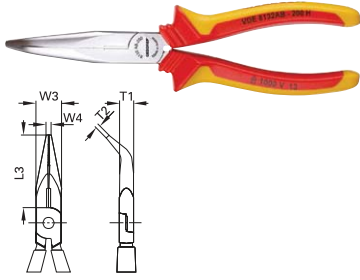

- > Long, flat-round jaws, straight gripping faces, serrated
- > tips 45° angled

- > Protective insulation up to 1000 V, according to EN 60900/IEC 60900
- > Sleeve insulation

Code	No.	L	L3	W3	W4	T1	T2	
1552139	VDE 8132 AB-160 H	160	46	16,5	3,2	9,0	2,5	0,173
1552147	VDE 8132 AB-200 H	200	70,5	18,5	3,7	9,5	2,8	0,235

VDE S 8003

VDE Pliers set
with VDE dipped
insulation 3 pieces



- > Protective insulation up to 1000 V, according to EN 60900/IEC 60900
- > Immersion insulation: 2-fold Check-Tool insulation

Code	No.	Contents	Pieces	
6708120	VDE S 8003	VDE 8132-160 VDE 8250-180 VDE 8314-160	3	0,76

VDE S 8003 H

VDE Pliers set
with VDE insulating
sleeves 3 pieces



- > Protective insulation up to 1000 V, according to EN 60900/IEC 60900
- > Sleeve insulation

Code	No.	Contents	Pieces	
1550594	VDE S 8003 H	VDE 8132-160 H VDE 8250-180 H VDE 8314-160 H	3	0,747

1101-003 VDE

VDE Tool set
in i-BOXX® 72, 8 pieces



- > Individually tested, insulated up to 1000 V, according to EN 60900/IEC 60900, except voltage tester No. 4615
- > In GEDORE i-BOXX® 72

Code	No.	Contents	Pieces	
1828045	1101-003 VDE	VDE 8132-200 H VDE 8250-180 H VDE 8314-160 H VDE 2170 4 5.5 VDE 2160 PH 1 2 4615 3	8	2,3

1102-002 VDE

VDE Pliers set
3 pieces



- > Practical set composition
- > Sleeve insulation
- > In GEDORE L-BOXX® Mini, incl. divider set

Code	No.	Contents	Pieces	
1692291	1102-002 VDE	VDE 8132-160 H VDE 8250-180 H VDE 8314-160 H	3	0,92

1102-004 VDE

VDE Pliers set
3 pieces



- > Protective insulation up to 1000 V, according to EN 60900/IEC 60900
- > Sleeve insulation
- > In GEDORE L-BOXX® Mini, incl. divider set

Code	No.	Contents	Pieces	
1708244	1102-004 VDE	VDE 8098-160 H VDE 8250-180 H VDE 8314-160 H	3	0,95

1102-005 VDE

VDE Pliers set
3 pieces



- > Insulated up to 1000 V, according to EN 60900/IEC 60900
- > Sleeve insulation
- > With VDE Impact diagonal cutter and VDE multiple nose pliers
- > In GEDORE L-BOXX® Mini, including range of dividers

Code	No.	Contents	Pieces	
2951762	1102-005 VDE	VDE 8314-180 H VDE 8131 AB-200 H VDE 2162 PZ 1	3	0,955

1102-006 VDE

VDE Tool set
4 pieces



- > Insulated up to 1000 V, according to EN 60900/IEC 60900
- > For all usual electric master cabinets incl. multi fitting key
- > In GEDORE L-BOXX® Mini, incl. divider set

Code	No.	Contents	Pieces	
2951770	1102-006 VDE	VDE 8131 AB-200 H VDE 2172 3,5 VDE 2164 SL/PH 2 45 E	4	0,86

VDE 1001

VDE Tool set
14 pieces



- > With practical foam insert in sturdy PVC case
- > Dimensions: 395 x 295 x 106 mm

- > Offset screwdriver No. 42 not insulated

Code	No.	Contents	Pieces	
6602560	VDE 1001	VDE 19 10 12 13 14 17 19 22 24 VDE 1993 U VDE 1990-5-10 VDE 1989 T VDE 2170 5,5 42 2,5	14	3,46

Insulated tools

1100-1094

VDE tool assortment HYBRID
53 pieces



- > The perfect range of tools for repair and maintenance work on hybrid and electric vehicles
- > Suitable for vehicles of all manufacturers

- > All tools insulated according to EN 60900/EC 60900
- > In GEDORE L-BOXXÄ® 136

Code	No.	Contents	Pieces	kg
2979063	1100-1094	3/8" VDE socket wrench insert No. VDE 30, SW 6 8 9 10 11 12 13 14 15 16 17 18 19 20 22 mm 3/8" VDE screwdriver bit socket No. VDE INX 30, SW 8 10 12 mm 3/8" VDE extension No. VDE 3090 -3 -6, 75 150 mm 3/8" VDE reversible ratchet No. VDE 3093 U VDE Screwdriver slot No. VDE 2170, 2.5 3.5 4.5 5.5 mm VDE Screwdriver Cross-recess No. VDE 2160 PH 1 2 3 VDE Screwdriver TX No. VDE 2163 TX T20 T25 T30 VDE cable cutter No. VDE 8094, 200 mm VDE Universal pliers No. VDE 146 10, 10". VDE Power combination pliers No. VDE 8250-200 H, 200 mm 2-component handle VDE Power side cutter No. VDE 8314-180 H, 180 mm VDE Flat nose pliers No. VDE 8132 AB-200 JC, 200 mm angled 2-component handle VDE Flat nose pliers No. VDE 8120-160 H, 160 mm 2-component handle VDE cable knife No. VDE 4522, 180 mm Counter sleeve No. V 914, size 1 2 3	53	8,28

1041-003

VDE Tool assortment in case
74 pieces



- > A practical assortment for on-site use
- > Packed in a strong plastic case made from impact-proof ABS
- > Sturdy aluminium frame

Code	No.	Contents	Pieces	kg
3082156	1041-003	Combination wrench No. 7, SW 10 13 17 19 22 mm 1/4" Adjustable open-end wrench No. 60 P 8, 8". Bit socket wrench box No. 666-U-20, with ratchet 35 pcs Offset screwdriver set No. PH 42-88, SW 2 2.5 3 4 5 6 8 10 mm VDE Screwdriver slot No. VDE 2170, 3 3.5 4 5.5 6.5 8 mm VDE Screwdriver cross-head No. 2160 PH 0 1 2 VDE Wire stripper VDE 8098-160 H VDE Multi-pliers No. VDE 8131 AB-200 H VDE Power combination pliers No. VDE 8250-180 H VDE Power side cutters No. VDE 8316-180 H VDE Universal pliers No. VDE 146 10, 10". VDE Cable knife No. VDE 4522, 180 mm Cable knife No. 0513-09, blade L.90mm Voltage Detector Slot No. 4615 3, 220-250 V, 3mm Non-return soft-face and engineer's hammer KOMBI-PLUS R 247 H-30 Percussion tool set No. 106, 6 pcs. Steel tape measure No. 4534-3, tape L. 3 m Volume tool case WK 1041 L	74	10,3

VDE 910

VDE Rubber cover sheet



- > VDE protective equipment according to VDE 0680 part 1
- > Thickness: 1.6 mm
- > Rolled storage prevents from cracking!

Code	No.	L	W	
1826816	VDE 910 13	130	130	0,04
1826832	VDE 910 25	250	350	0,21
1827030	VDE 910 50	500	500	0,43
1828193	VDE 910 60	600	600	0,7
1828207	VDE 910 100	1.000	1.000	1,8
1828215	VDE 910 120	1.200	1.200	2,95

VDE 911

VDE Insulation mat



- > VDE protective equipment according to VDE 0303
- > Thickness: 4.5 mm
- > Rolled storage prevents from cracking!

Code	No.	L	W	
1828258	V 911 100	1.000	1.000	0,006
1828266	V 911 1000	10.000	1.000	0,06

VDE 912

VDE-electricians' safety-gloves



- > Acc. to DIN EN 60903
- > Made of natural latex
- > Suitable up to 1000 V

Code	No.	
1828274	V 912 9	0,215
1828282	V 912 10	0,215

VDE 912

Under-gloves for VDE 912



- > Made of cotton
- > For use with electrician's protective gloves No. V 912 9 and 10
- > Universal size

Code	No.	
1828290	V 912 50	0,05

V 915

NH-Fuse insertion glove with sleeve



- > To work on NH fuse inserts sizes 00 to 3
- > To insert and remove low-tension high-performance fuses (NH fuse inserts)
- > With contact blades to DIN 43620 Part 1, sizes 00 - 3 for nominal voltage to 600 V alternating voltage

Code	No.	
2661314	V 915	0,46

Insulated tools

V 913

VDE Plastic clamp
1000 V



- > For fixing and joining plastic clamps
- > Inserted steel spring which externally cannot be accessed
- > Suitable up to 1000 V

Code	No.	l mm >	kg
1828304	V 913 80	80	0,03
1828312	V 913 160	160	0,075

VDE 914

Meter connection fittings



- > For insulating single cores
- > Conical form
- > Made of tough elastic plastic

Code	No.	l mm >	∅	kg
2324938	V 914 1	80	10,0	0,005
2324946	V 914 2	80	10,0	0,005
2324954	V 914 3	80	10,0	0,005

V 917

Cable splitting wedge



- > Insulated according to IEC 60900
- > Suitable for mounting cable feeder terminals and splaying primary conductor cables
- > Assistance when cutting cable cores, no slipping

Code	No.	kg
2661462	V 917	0,16

VDE 4522

VDE Cable knife



- > Strong, straight blade made from hardened and tempered steel
- > With blade protector
- > Insulated up to 1000 V, according to EN 60900/IEC 60900

Code	No.	l mm >	l mm >	kg
6690400	VDE 4522	50	180	0,104

VDE 4527

VDE Cable knife
with hooked blade



- > For slitting and stripping damp-proof installation cables
- > With blade protector
- > Insulated up to 1000 V, according to EN 60900/IEC 60900

Code	No.	l mm >	l mm >	kg
6698490	VDE 4527	40	203	0,098

4528

Universal cable knife



- > For stripping round cables, 4 - 28 mm
- > Hooked blade for separating cable strips and flat cables
- > Automatic changeover of the blade from round to longitudinal cut without putting down the knife
- > The cutting depth of the pivoting internal knife is adjustable

Code	No.			
6698300	4528	50	170	0,155

E-4528

Spare-blades



- > The cutting depth of the pivoting internal knife is adjustable

Code	No.	
1448161	E-4528	0,005

4529

Multi-use cable knife



- > For stripping round cables, 4 - 28 mm
- > Integrated stripping function for flexible and single-strand conductors
- > Automatic changeover of the blade from round to longitudinal cut without putting down the knife
- > The cutting depth of the pivoting internal knife is adjustable

Code	No.		
2955393	4529	145	0,15

E-4529

Spare-blades



- > The cutting depth of the pivoting internal knife is adjustable

Code	No.	
2955407	E-4529	0,111

4629

Insulating tape



Code	No.	L m	<u>mm</u>	
6699540	4629	10	15	0,032

V 406

Small saw for metal

 1000 V

- > For pinned hacksaw blades, 148 mm
- > Suitable up to 1000 V

Code	No.	 mm	
6120060	V 406	265	0,229