

KATALOG / CATALOGUE 2024



Über 45 Jahre Kompetenz aus Remscheid

- ⚙ Rund 9.500 Produkte ab Lager lieferbar
- ⚙ Abmessungsbereich von 0,3 – 120,0 mm
- ⚙ Modernes EDV- und Logistikkonzept
- ⚙ Lieferquote von 98%
- ⚙ Standardversand innerhalb 24 Stunden
- ⚙ Lieferung in über 60 Länder
- ⚙ Über 1.500 Fachhandelskunden

More than 45 years of expertise from Remscheid

- ⚙ Approx. 9,500 products available from stock
- ⚙ Dimension range from 0.3 – 120.0 mm
- ⚙ Modern IT and logistic concept
- ⚙ 98% delivery performance
- ⚙ Possible shipping within 24 hours
- ⚙ Deliveries to more than 60 countries
- ⚙ More than 1,500 retail partners





Premium Qualität für hochpräzise Bearbeitung

Unsere Marke für Zerspanungswerkzeuge auf höchstem Qualitätsniveau

Premium quality for high precision machining

Our brand for cutting tools with highest quality-level



Industriequalität für präzise Bearbeitung

Zerspanungswerkzeuge für hohe Beanspruchung und lange Lebensdauer

Industrial quality for precise machining

Cutting tools for high operational demands and long tool life



Robuste Qualität für Industrie und Handwerk

Die bewährte Marke für normale Beanspruchung

Robust quality for industry and craft

The reliable quality for normal operational demands



24
-
103



Spiralbohrer / Twist drills



104
-
111



HM Spiralbohrer / TC Twist drills

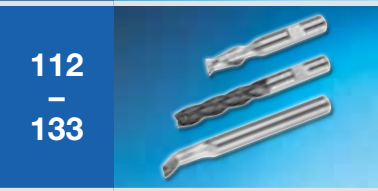

112
-
133



Schafffräser / End mills HSS-E · HSS-E PM



134
-
149



VHM Schafffräser / Solid carbide end mills



150
-
157



Kernbohrer · HM-Lochsägen / Core drills · TCT-Hole saws

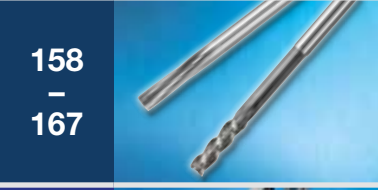

158
-
167



Reibahlen / Reamers



168
-
245



Gewindeschneidwerkzeuge / Thread cutting tools



246
-
257



Gewindereparatur / Thread repair



258
-
283



Senker · Stufenbohrer / Countersinks · Step drills

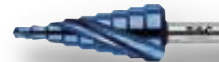

284
-
291



Entgrater / Deburring tools



292
-
297



Frässtifte HSS / Rotary burrs HSS



298
-
317



Frässtifte HM / Rotary burrs TC



Schmierstoffe / Lubricants



318
-
325

Bohrfutter & Zubehör / Drill chucks & accessories



326
-
333

Stein- und Betonbohrer / Masonry · Concrete drill bits



334
-
357

Diamantwerkzeuge / Diamond tools



358
-
369

Holzbohrer / Wood drill bits



370
-
383

Lochsägen / Hole saws



384
-
393

Sägeblätter / Saw blades



394
-
409

Schraublochstanzen / Screw-hole punch



410
-
413

Schrauber-Bits & Zubehör / Screwdriver-bits & accessories



414
-
433

Schraubenausdreher & Reißnadeln / Screw extractors & steel scriber



244
-
245

Leerkassetten · Verkaufsschränke / Empty boxes · Drill cabinets

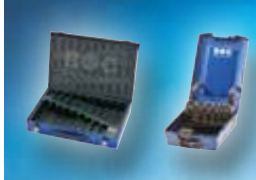
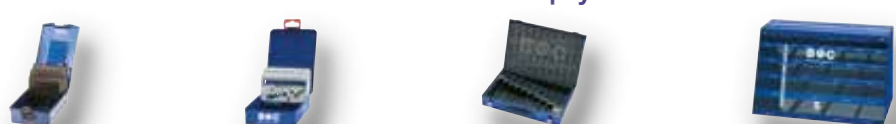

434
-
441

Technische Informationen / Technical information





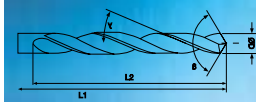





















































Einsatzempfehlungen, Umrechnungstabellen, Härtevergleichstabelle
Application recommendation, conversion tables, hardness comparison table









442
-
459

	DIN	Qualität Quality	Typ Type	Bezeichnung Description	Code	Seite Page
Spiralbohrer / Twist drills						
	338	HSS-R	N	Spiralbohrer rollgewalzt, zylindrisch + reduziert Twist drills roll forged, straight + reduced	1100 1109	34 – 38
	338	HSS-G	N	Spiralbohrer geschliffen, zylindrisch + reduziert Twist drills fully ground, straight + reduced	1120 1110	39 – 43
	338	HSS-TiN	N	Spiralbohrer TiN-beschichtet, Kreuzanschliff Twist drills TiN-coated, split point	1130	44
	338	HSS-G	N	Spiralbohrer geschliffen, zylindrisch + reduziert Twist drills fully ground, straight + reduced	1121 1121-red.	45 – 47
	338	HSS-G	N	Spiralbohrer geschliffen, dampfangelassen Twist drills fully ground, black oxide finish	1119	45 – 46
	338	HSS-G	N	Spiralbohrer geschliffen, zylindrisch + reduziert Twist drills fully ground, straight + reduced	1122 1122-red.	48 – 50
	338	HSS-TiN	N	Spiralbohrer TiN-beschichtet, Kreuzanschliff Twist drills TiN-coated, split point	1123	48 – 49
	338	HSS-TiN	N-TP	Spiralbohrer TiN-Point, Kreuzanschliff Twist drills TiN-Point, split point	1124	51 – 52
	338	HSS-G	LN	Spiralbohrer geschliffen LINKS, Kreuzanschliff Twist drills LEFT fully ground, split point	1129	53
	338	HSS-G	TURBO	Spiralbohrer geschliffen, mit Zentrierspitze Twist drills fully ground, with centering-tip	1201	54 – 55
	338	HSS-G	TURBO STEP	Spiralbohrer geschliffen, mit Stufengeometrie Twist drills fully ground, with step geometry	1202	56 – 57
	1897	HSS-G	TURBO STEP	Spiralbohrer geschliffen, mit Stufengeometrie, reduzierter Schaft Twist drills fully ground, with step geometry, reduced shank	1204	58
	338	HSS-G	W	Spiralbohrer geschliffen für ALUMINIUM Twist drills fully ground for ALUMINIUM	1127	60
	338	HSS-G	H	Spiralbohrer geschliffen für MESSING Twist drills fully ground for BRASS	1128	61
	338	HSS-G	HK	Spiralbohrer geschliffen für KUNSTSTOFFE Twist drills fully ground for SYNTHETIC MATERIALS	1131	62
	338	HSS-E Co5	N	Spiralbohrer kobaltlegiert, zyl. + reduziert Twist drills cobalt alloyed, straight + reduced	1140 1140-red.	63 – 66
	338	HSS-E Co5	TURBO STEP INOX	Spiralbohrer kobaltlegiert, mit Stufengeometrie Twist drills cobalt alloyed, with step geometry	1203	67
	338	HSS-E Co5	VA/Ti	Spiralbohrer kobaltlegiert, Kreuzanschliff Twist drills cobalt alloyed, split point	1141	68 – 69

	DIN	Qualität Quality	Typ Type	Bezeichnung Description	Code	Seite Page
Spiralbohrer / Twist drills						
		338	HSS-E Co5	VA/Ti Spiralbohrer kobaltlegiert, TiALN-beschichtet, Kreuzanschliff Twist drills cobalt alloyed, TiALN-coated, split point	1143	68 – 69
		338	HSS-E Co5	U-TL Mehrbereichsbohrer kobaltlegiert, Kreuzanschliff Multigrade drills cobalt alloyed, split point	1142	70 – 71
		338	HSS-E Co5	U-TL Mehrbereichsbohrer kobaltlegiert, TiALN-beschichtet, Kreuzanschliff Multigrade drills cobalt alloyed, TiALN-coated, split point	1144	70 – 71
		338	HSS-E Co5	N-Z3 Spiralbohrer kobaltlegiert, mit 3-Schneiden Twist drills cobalt alloyed, with 3 cutting edges	1149	72 – 73
		338	HSS-E Co8	N-HD Spiralbohrer kobaltlegiert, Kreuzanschliff Twist drills cobalt alloyed, split point	1147	74 – 75
		338	HSS-E Co8	N-HD Spiralbohrer kobaltlegiert, TiALN-beschichtet, Kreuzanschliff Twist drills cobalt alloyed, TiALN-coated, split point	1148	74 – 75
		338	HSS-E Co8	HDX Spiralbohrer kobaltlegiert, für HARDOX Twist drills cobalt alloyed, for HARDOX	1508	76 – 77
		338	VHM SC	N VHM Spiralbohrer TiALN-beschichtet Solid carbide twist drills TiALN-coated	1502	106 – 107
Spiralbohrer lang / Twist drills long						
		340	HSS-R	N Spiralbohrer rollgewalzt, lang Twist drills roll forged, long	1340	78
		340	HSS-G	N Spiralbohrer geschliffen, lang, Kreuzanschliff Twist drills fully ground, long, split point	1350	79
		340	HSS-G	N Spiralbohrer geschliffen, lang, Kreuzanschliff Twist drills fully ground, long, split point	1353	80
		340	HSS-E Co5	N Spiralbohrer kobaltlegiert, lang, Kreuzanschliff Twist drills cobalt alloyed, long, split point	1360	81
		340	HSS-E Co5	N Spiralbohrer kobaltlegiert, lang, TiN-beschichtet, Kreuzanschliff Twist drills cobalt alloyed, long, TiN-coated, split point	1361	81
		340	HSS-E Co5	U-TL Mehrbereichsbohrer kobaltlegiert, lang, Kreuzanschliff Multigrade drills cobalt alloyed, long, split point	1362	82
Spiralbohrer extra lang / Twist drills extra long						
		1869	HSS-G	N Spiralbohrer geschliffen, extra lang, Kreuzanschliff Twist drills fully ground, extra long, split point	1400	83

	DIN	Qualität Quality	Typ Type	Bezeichnung Description	Code	Seite Page
Spiralbohrer extra lang / Twist drills extra long						
		1869	HSS-G	U-TL Mehrbereichsbohrer geschliffen , extra lang, Kreuzanschliff Multigrade drills fully ground , extra long, split point	1410	84
		1869	HSS-E Co5	U-TL Mehrbereichsbohrer kobaltlegiert , extra lang, Kreuzanschliff Multigrade drills cobalt alloyed , extra long, split point	1420	85
		BC Norm	HSS-G	N Hohlprofil- / Dachdeckerbohrer geschliffen , Kreuzanschliff Twist drills for hollow profiles, fully ground , split point	1440	86
Spiralbohrer extra kurz / Twist drills extra short						
			HSS-G	Spiralbohrer-Bits geschliffen ¼" Schaft Twist drill bits fully ground , ¼" hex-shank	1104	87
		BC Norm	HSS-G	N Anbohrer / Stoßbohrer geschliffen , Kreuzanschliff Rivet Drills fully ground , extra short, split point	1200	88
		1897	HSS-G	N Spiralbohrer geschliffen , extra kurz, Kreuzanschliff Twist drills fully ground , extra short, split point	1250	89
		1897	HSS-G	N Spiralbohrer geschliffen , extra kurz, Kreuzanschliff Twist drills fully ground , extra short, split point	1255	90
		1897	HSS-E Co5	N Spiralbohrer kobaltlegiert , extra kurz, Kreuzanschliff Twist drills cobalt alloyed , extra short, split point	1260	91
		1897	HSS-E Co5	N Spiralbohrer kobaltlegiert , extra kurz, Kreuzanschliff Twist drills cobalt alloyed , extra short, split point	1265	92
		1897	HSS-E Co5	N Spiralbohrer kobaltlegiert , extra kurz, TiN-beschichtet , Kreuzanschliff Twist drills cobalt alloyed , extra short, TiN-coated , split point	1266	92
		8037	HSS HM TCT	N Spiralbohrer mit HM-Schneide Twist Drills, carbide tipped	1500	110
		6539	VHM SC	N VHM Spiralbohrer, extra kurz TiALN-beschichtet Solid carbide twist drills, extra short, TiALN-coated	1504	108 – 109
Zentrierbohrer / Centre drills						
		333 A	HSS-G	60° Zentrierbohrer Form A Centre drills type A	1600	93

		DIN	Qualität Quality	Typ Type	Bezeichnung Description	Code	Seite Page
Doppelendbohrer / Double ended drills							
		BC Norm	HSS-G	N	Doppelendbohrer geschliffen, Kreuzanschliff Double ended drills fully ground, split point	1300	94
		BC Norm	HSS-G	N	Doppelendbohrer geschliffen, Kreuzanschliff Double ended drills fully ground, split point	1301	95
		BC Norm	HSS-E Co5	N	Doppelendbohrer kobaltlegiert, Kreuzanschliff Double ended drills cobalt alloyed, split point	1310	95
Spiralbohrer mit Morsekonus / Taper shank twist drills							
		345	HSS	N	Spiralbohrer MK Taper shank drills	1450	96 – 97
		345	HSS-G	N	Spiralbohrer MK gefräst Taper shank drills milled	1451	98 – 99
		345	HSS-E Co5	N	Spiralbohrer MK kobaltlegiert Taper shank drills cobalt alloyed	1470	100
		341	HSS-G	N	Spiralbohrer MK gefräst, lang Taper shank drills milled, long	1455	101
Schweißpunktbohrer und Fräser / Spot weld drills and milling cutters							
		DIN 1897	HSS-E Co5	N	Schweißpunktbohrer Spot weld drills	1801	102
		DIN 1897	HSS-E Co5	N	Schweißpunktbohrer TiN-beschichtet Spot weld drills, TiN-coated	1802	102
		DIN 1897	HSS-E Co5	N	Schweißpunktbohrer TiALN-beschichtet Spot weld drills, TiALN-coated	1803	102
		BC Norm	VHM SC		VHM Schweißpunktbohrer mit 3 Schneiden, TiALN-beschichtet Solid carbide spot weld drill with 3 cutting edges, TiALN-coated	1807	103
		BC Norm	HSS-E Co5		Schweißpunktbohrer für Spotle T575 und Vario WS90 Spot weld drills for Spotle T575 and Vario WS90	1810	102
		BC Norm	HSS-E Co5		Schweißpunktbohrer TiN-beschichtet, für T575 und Vario WS90 Spot weld drills TiN-coated for Spotle T575 and Vario WS90	1811	102
		BC Norm	HSS-E Co5		Schweißpunktbohrer TiALN-beschichtet, für T575 und Vario WS90 Spot weld drills TiALN-coated for Spotle T575 and Vario WS90	1812	102
		BC Norm	VHM SC		VHM Schweißpunktbohrer mit 3 Schneiden für Vario WS 90, TiALN-beschichtet Solid carbide spot weld drill with 3 cutting edges for Vario WS 90, TiALN-coated	1806	103
		BC Norm	HSS		Schweißpunktfräser und Zubehör Spot-Weld milling cutters and spare parts	1805	102

	DIN	Qualität Quality	Typ Type	Version	Schneiden Flutes	Schaft Shank	Bezeichnung Description	Code	Seite Page
	-	HSS-E Co5	W	kurz short	1	DIN 1835 A	Einzahnfräser Single fluted end mills	5345	118
	-	HSS-E Co5	W	lang long	1	DIN 1835 A	Einzahnfräser Single fluted end mills	5350	119
	844	HSS-E Co8	W	kurz short	2	DIN 1835 B	Langlochfräser Slot end mills	5355	120
	844	HSS-E Co8	W	kurz short	3	DIN 1835 B	Bohrnutenfräser Slot end mills	5365	121
	327	HSS-E Co8	N	kurz short	2	DIN 1835 B	Langlochfräser Slot end mills	5300	122 – 123
	327	HSS-E Co8	N	kurz short	2	DIN 1835 B	Langlochfräser, TiALN Slot end mills, TiALN	5301	122 – 123
	-	HSS-E Co8	N	lang long	2	DIN 1835 B	Langlochfräser Slot end mills	5305	124
	-	HSS-E Co8	N	lang long	2	DIN 1835 B	Langlochfräser, TiALN Slot end mills, TiALN	5306	124
	327	HSS-E Co8	N	kurz short	3	DIN 1835 B	Bohrnutenfräser Slot end mills	5310	125
	327	HSS-E Co8	N	kurz short	3	DIN 1835 B	Bohrnutenfräser, TiALN Slot end mills, TiALN	5311	125
	844	HSS-E Co8	NR	kurz short	4 – 6	DIN 1835 B	Schrupfräser Roughing end mills	5325	126
	844	HSS-E Co8	NR	kurz short	4 – 6	DIN 1835 B	Schrupfräser, TiALN Roughing end mills, TiALN	5326	126
	844	HSS-E Co8	NR	lang long	4 – 6	DIN 1835 B	Schrupfräser Roughing end mills	5330	127
	844	HSS-E Co8	NR	lang long	4 – 6	DIN 1835 B	Schrupfräser, TiALN Roughing end mills, TiALN	5331	127
	844	HSS-E Co8	HR	kurz short	4 – 6	DIN 1835 B	Schrupfräser Roughing end mills	5335	128
	844	HSS-E Co8	HR	kurz short	4 – 6	DIN 1835 B	Schrupfräser, TiALN Roughing end mills, TiALN	5336	128
	844	HSS-E Co8	N	kurz short	4 – 6	DIN 1835 B	Schaftfräser Finishing end mills	5315	129
	844	HSS-E Co8	N	kurz short	4 – 6	DIN 1835 B	Schaftfräser, TiALN Finishing end mills, TiALN	5316	129
	844	HSS-E Co8	N	lang long	4 – 6	DIN 1835 B	Schaftfräser Finishing end mills	5320	130
	844	HSS-E Co8	N	lang long	4 – 6	DIN 1835 B	Schaftfräser, TiALN Finishing end mills, TiALN	5321	130





















SCHAFTFRÄSER HSS-E PM · VHM / KERNBOHRER END MILLS HSS-E PM · SC / CORE DRILLS

		DIN	Qualität Quality	Typ Type	Version	Schneiden Flutes	Schaft Shank	Bezeichnung Description	Code	Seite Page
Schaftfräser HSS-E PM / End mills HSS-E PM										
		844	HSS-E PM	HR	kurz short	4 – 5	DIN 1835 B	Schrupfräser, AITiN Roughing end mills, AITiN	5435	131
		844	HSS-E PM	N	kurz short	4 – 5	DIN 1835 B	Schaftfräser, AITiN Finishing end mills, AITiN	5415	132
		844	HSS-E PM	N	lang long	4 – 5	DIN 1835 B	Schaftfräser, AITiN Finishing end mills, AITiN	5420	133
Schaftfräser VHM / Solid carbide end mills										
		-	VHM SC	W	kurz short	1	DIN 6535 HA	Einzahnfräser Single fluted end mills	5500	138
		-	VHM SC	W	kurz short	2	DIN 6535 HA/HB	Langlochfräser Slot end mills	5505 5506	139
		~ 6527 L	VHM SC	W	lang long	3	DIN 6535 HA/HB	Bohrnutenfräser Slot end mills	5510 5511	140
		~ 6527 L	VHM SC	N	kurz short	2	DIN 6535 HA/HB	Langlochfräser, AITiN Slot end mills, AITiN	5515 5516	141
		~ 6527 L	VHM SC	N	lang long	3	DIN 6535 HA/HB	Bohrnutenfräser, AITiN Slot end mills, AITiN	5520 5521	142
		~ 6527 L	VHM SC	N	lang long	4	DIN 6535 HA/HB	Schaftfräser, AITiN Finishing end mills, AITiN	5525 5526	143
		~ 6527 L	VHM SC	N	extra lang / long	4	DIN 6535 HA/HB	Schaftfräser, AITiN Finishing end mills, AITiN	5530 5531	144
		6527 L	VHM SC	HPC	lang long	4	DIN 6535 HA/HB	HPC Schaftfräser, AITiN HPC end mills, AITiN	5535 5536	145
		~ 6527 L	VHM SC	NH	lang long	6	DIN 6535 HA/HB	Schaftfräser, AITiN Finishing end mills, AITiN	5540 5541	146
		~ 6527 L	VHM SC	HRf	lang long	3 – 5	DIN 6535 HA/HB	Schrupfräser, AITiN Roughing end mills, AITiN	5545 5546	147
		~ 6527 L	VHM SC	N	lang long	2	DIN 6535 HA	Radiusfräser, AITiN Ball nose end mills, AITiN	5550	148
		-	VHM SC	N	lang long	4	DIN 6535 HA	Entgratfräser, TiALN Deburring end mills, TiALN	5555	149
Kernbohrer + Zubehör / Core drills + accessories										
		HSS						Kernbohrer mit Weldonschaft 30 und 55 mm Schnitttiefe Core drills with weldon shank 30 and 55 mm cutting depth	1950	153
		HSS-E Co						Kernbohrer mit Weldonschaft 30 und 55 mm Schnitttiefe Core drills with weldon shank 30 and 55 mm cutting depth	1951	154
		HM TCT						Kernbohrer HM mit Weldonschaft 35 und 55 mm Schnitttiefe Core drills TCT with weldon shank 35 and 55 mm cutting depth	1952	155

		Qualität Quality	Bezeichnung Description		Code	Seite Page		
Kernbohrer + Zubehör / Core drills + accessories								
		-	Zubehör für Kernbohrer Accessories for core drills		1955 – 1957	156		
HM-Lochsägen / TCT-Hole saws								
		HM TCT	Mehrbereichs-Lochsägen HM + Zubehör Multigrade hole saws TCT + accessories		1920 1925	157		
		DIN	Qualität Quality	Form	Bezeichnung Description	Code	Seite Page	
Reibahlen / Reamers								
		206	HSS	B	Handreibahlen Hand reamers	1670	161	
		9	HSS	B	Hand-Kegelreibahlen Taper hand reamers	1671	162	
		311	HSS		Nietloch-Reibahlen MK Taper shank bridge reamers	1672	163	
		212	HSS-E Co5	B/D	Maschinen-Reibahlen Machine reamers	1673	164	
		212	HSS-E Co5	C	NC Maschinen-Reibahlen NC Machine reamers	1674	165	
		208	HSS-E Co5	B	Maschinen-Reibahlen MK Taper shank machine reamers	1675	166	
		Gewinde Thread		Form	Qualität Quality	DIN	Code	Seite Page
Handgewindebohrer / Hand taps								
		M		-	HSS-G	352	4100	178 – 179
		M		-	HSS-E VAP	352	4110	180
		M (LH) links / left		-	HSS-G	352	4109	181
		MF		-	HSS-G	2181	4101	214 – 215
		G (BSP)		-	HSS-G	5157	4102	222
		BSW		-	HSS-G	~ 352	4103	228
		UNC		-	HSS-G	~ 352	4104	231
		UNF		-	HSS-G	~ 2181	4105	235







































		Gewinde Thread	Form	Qualität Quality	DIN	Code	Seite Page
Schneideisen / Circular dies							
		M	B	HSS-G	EN 22568	4200 4201 (25x9)	182 – 183
		M	B	HSS-E VAP	EN 22568	4210	184
		M (LH) links / left	B	HSS-G	EN 22568	4209	185
		MF	B	HSS-G	EN 22568	4202	216 – 217
		G (BSP)	B	HSS-G	EN 24231	4203	223
		BSW	B	HSS-G	EN 22568	4205	229
		UNC	B	HSS-G	EN 22568	4206	232
		UNF	B	HSS-G	EN 22568	4207	236
Schneidmuttern / Hexagon die nuts							
		M	-	HSS-G	382	4204	186
		G (BSP)	-	HSS-G	382	4208	224
Maschinengewindebohrer / Machine taps							
		M	B	HSS-G	371/376	4140, 4141	192 – 193
		M	C RSP 35° C SFT 35°	HSS-G	371/376	4150, 4151	192 – 193
		M	B	HSS-E	371/376	4142, 4143	194 – 195
		M	C RSP 35° C SFT 35°	HSS-E	371/376	4152, 4153	196 – 197
		M	B	HSS-E TiN	371/376	4147, 4148	194 – 195
		M	C RSP 35° C SFT 35°	HSS-E TiN	371/376	4157, 4158	196 – 197
		M (XL)	B	HSS-E	371/376	4161	207
		M (XL)	C RSP 35° C SFT 35°	HSS-E	371/376	4162	207
		M (LH) links / left	C	HSS-E	371/376	4159	208
		MF	B	HSS-E	374	4165	219
		MF	C RSP 35° C SFT 35°	HSS-E	374	4166	219
		G (BSP)	B	HSS-E	5156	4175	226
		G (BSP)	C RSP 35° C SFT 35°	HSS-E	5156	4176	226
		UNC	B	HSS-E	~ 371/376	4196	234
		UNC	C RSP 35° C SFT 35°	HSS-E	~ 371/376	4197	234
		UNF	B	HSS-E	~ 371/376	4198	238

		Gewinde Thread	Form	Qualität Quality	DIN	Code	Seite Page
Maschinengewindebohrer / Machine taps							
		UNF	C RSP 35° C SFT 35°	HSS-E	~ 371/376	4199	238
		M	-	HSS-E	-	4172	209
		M	B	HSS-E PM	371/376	4169, 4170	200
		M	C RSP 40° C SFT 40°	HSS-E PM	371/376	4179, 4180	200
		M	B	HSS-E	371/376	4163, 4164	198
		M	C RSP 40° C SFT 40°	HSS-E	371/376	4167, 4168	199
		M	B	HSS-E TiN	371/376	4183, 4184	198
		M	C RSP 40° C SFT 40°	HSS-E TiN	371/376	4187, 4188	199
		M	B	HSS-E TiALN	371/376	4181, 4182	198
		M	C RSP 40° C SFT 40°	HSS-E TiALN	371/376	4185, 4186	199
		MF	C	HSS-E	374	4139	220
		G	C	HSS-E	5156	4247	227
		M	B	HSS-E	371/376	4173, 4174	202
		M	C RSP 40° C SFT 40°	HSS-E	371/376	4177, 4178	203
		M	B	HSS-E TiALN	371/376	4189, 4190	202
		M	C RSP 40° C SFT 40°	HSS-E TiALN	371/376	4191, 4192	203
		M	B	HSS-E VAP	371/376	4144, 4145	201
		M	C RSP 40° C SFT 40°	HSS-E VAP	371/376	4154, 4155	201
		MF	B	HSS-E VAP	374	4146	221
		MF	C RSP 40° C SFT 40°	HSS-E VAP	374	4156	221
		M	C	HSS-E TiCN	371/376	4193	206
		M	C RSP 45° C SFT 45°	HSS-E	371/376	4149	204
		M	B-AZ	HSS-E	371/376	4240	205
Gewindeformer / Forming/Fluteless taps							
		M	D	HSS-E TiN	371/376	4243	212
		M	C	HSS-E TiN	371/376	4245	213
Einschnittgewindebohrer / Short machine taps							
		M	B	HSS-G	352	4120	187
		M	B	HSS-E	352	4125	188
		M	C	HSS-G	352	4121	189
		M	C	HSS-E VAP	352	4111	190
		M (LH) links / left	C	HSS-G	352	4129	191
		MF	C	HSS-G	2181	4131	218
		G (BSP)	C	HSS-G	5157	4132	225
		BSW	C	HSS-G	~ 352	4133	230

	Gewinde Thread	Form	Qualität Quality	DIN	Code	Seite Page
Einschnittgewindebohrer / Short machine taps						
	UNC	C	HSS-G	~ 352	4134	233
	UNF	C	HSS-G	~ 2181	4135	237
	NPT	C	HSS-G	BC Norm	4136	239
	PG	C	HSS-G	40432	4130	240
	M	C	HSS-G	-	4171	210
Maschinen-Muttergewindebohrer / Machine nut taps						
	M	-	HSS-G	357	4160	211
Verstellbare Windeisen / Adjustable tap wrenches						
				1814	4300	242
Schneideisenhalter / Die stocks						
				225	4400	242
Werkzeughalter mit Knarre / Tap wrenches with ratchet						
				BC Norm	4302	243
Gewindebohrerverlängerung / Extension sleeves						
				377	4500	243
Gewindefeilen / Thread restoring files						
				-	4501	241
Gewindeschablonen / Thread gauges						
				-	9651	241
Schraubenausdreher / Screw extractors						
			CV	-	9700	244
Hartmetall-Reißnadel / Steel scriber with carbide cutting point						
			HM TCT	-	9600	245
	Gewinde Thread	Bezeichnung Description			Code	Seite Page
Gewindereparatur / Thread repair						
	M	Gewindeeinsätze Thread inserts			4600 – 4604	248
	MF	Gewindeeinsätze Thread inserts			4610 – 4614	248
	MF (ZK / SPARK PLUG)	Gewindeeinsätze für Zündkerzengewinde Thread inserts for spark plug thread			4615	249
	M, MF	Gewindereparatursätze Thread repair sets			4601 4611 4615	250 – 253
	M, MF, UNC, UNF, BSW	Einbauwerkzeuge Fitting-tools			4700	254
	M, MF, UNC, UNF, BSW	Zapfenbrecher Pin-breaker			4701	255

		Gewinde Thread	Bezeichnung Description	Code	Seite Page		
Gewindereparatur / Thread repair							
		M, MF	STI Einschnittgewindebohrer STI short machine taps	4800 - 4801	256		
		MF (ZK / SPARK PLUG)	STI Kombi-Gewindebohrer STI combined-thread tap	4802	257		
Spiralbohrer / Twist drills							
			Spiralbohrer geschliffen, zylindrisch + reduziert Twist drills fully ground, straight + reduced	1121 1121-red.	257		
		DIN	Qualität Quality	Typ Type	Bezeichnung Description	Code	Seite Page
Senker / Countersinks							
		335 C	HSS AlCro	90°	Kegeisenker, UNGLEICHE TEILUNG Countersinks, UNEQUAL PITCH	1730 1731	264
		335 C	HSS-E blue+	90°	Kegeisenker, UNGLEICHE TEILUNG Countersinks, UNEQUAL PITCH	1732 1733	265
		335 C	VHM/SC blue+	90°	Kegeisenker, UNGLEICHE TEILUNG Countersinks, UNEQUAL PITCH	1715 1719	266
		335 C	HSS-E PM	90°	Kegeisenker Pulvermetall Countersinks powder metal	1714	267
		335 C	HSS TiN TiALN	90°	Kegeisenker Countersinks	1700 - 1702	268
		335 C	HSS-E Co5	90°	Kegeisenker kobaltlegiert Countersinks cobalt alloyed	1710	269
		335 C	HSS	90°	Kegeisenker, lange / extra lange Ausführung Countersinks, long / extra long version	1703-L 1703-EL	270
		BC Norm	HSS	90°	Kegeisenker-Bits 1/4" Schaft Countersinks, 1/4" hex-shank	1705	271
			HSS	90°	Handentgrater Hand deburring tools	1820	271
		335 D	HSS	90°	Kegeisenker mit Morsekegelschaft Countersinks with taper shank	1704	272
		334 C	HSS	60°	Kegeisenker Countersinks	1700-60	272
		BC Norm	HSS	75°	Kegeisenker Countersinks	1700-75	273
		BC Norm	HSS	120°	Kegeisenker Countersinks	1700-120	273
		BC Norm	HSS TiN	90°	Kegel- und Entgratsenker mit Querloch Countersinks with cross hole	1720 1721	274
		373	HSS TiN	180°	Flachsenker Flat countersinks	1706 - 1718	275
Mehrfasenstufenbohrer / Subland drills							
		8374 8376	HSS-G	90° 180°	Mehrfasenstufenbohrer Subland drills	1625 1626	276

	DIN	Qualität Quality	Typ Type	Bezeichnung Description	Code	Seite Page
Stufenbohrer / Step drills						
	BC Norm	HSS TiN blue+		Stufenbohrer mit Spiralnut Step drills with spiral flute	1763 - 1767	278
	BC Norm	HSS-E Co5 blue+		Stufenbohrer kobaltlegiert, mit Spiralnut Step drills cobalt alloyed, with spiral flute	1765 1766	279
	BC Norm	HSS TiN TiALN		Stufenbohrer Step drills	1760 - 1762	280
	BC Norm	HSS		Stufenbohrer mit Spiralnut, 1/4" Schaft Step drills with spiral flute, 1/4" hex-shank	1760-1/4"	281
Bleeschälbohrer / Sheet metal drills						
	BC Norm	HSS TiN TiALN		Bleeschälbohrer Sheet metal drills	1740 - 1742	282
	BC Norm	HSS-E Co5		Bleeschälbohrer kobaltlegiert Sheet metal drills cobalt alloyed	1743	283
	BC Norm	HSS TiN		Bleeschälbohrer mit Anschlag Sheet metal drills with backstop	1740-A 1741-A	283
		Qualität Quality	Typ Type	Bezeichnung Description	Code	Seite Page
Entgrater / Deburring tools						
				Handgriffe Handles	1650	286
				Klingenhalter Holders	1651	286
		HSS	BC-B	Entgrater-Klingen Deburring blades	1659	287
		HSS	BC-E	Entgrater-Klingen Deburring blades	1660	287
		HSS	BC1 BC2	Schnellentgrater Rapid deburrers	1653 1654	288
		HSS	BC-DS3 BC-DS8	Dreikantschaber Triangular scrapers	1656	288
		HSS	BC-C42	Ersatzklinge für BC-DS8 Spare blade for type BC-DS8	1661	288
		HSS	BC-HE1 BC-HE3 BC-HTB4	Handgriffe mit HSS-Klingen Handles with HSS-blades	1652	289
		HSS	BC-DE	Doppelentgrater mit HSS-Schneidscheiben Double deburrer with round HSS-blades	1655	290































		Qualität Quality	Typ Type	Bezeichnung Description	Code	Seite Page	
Entgrater / Deburring tools							
		HSS	BC-R12	Ersatzscheibenscheibe für Doppelentgrater BC-DE Spare round blade double deburrer BC-DE	1655	290	
Außen-Entgrater / Outer-deburring tools							
		HSS		Entgrater EGR Deburrers EGR	1648	291	
		HM		Entgrater EGR HM+ Deburrers EGR HM+	1648	291	
		DIN	Qualität Quality	Form Shape	Bezeichnung Description	Code	Seite Page
HSS Frässtifte / HSS Rotary burrs							
		BC Norm	HSS	B ZYAS	Frässtifte Zylinder mit Stirnverzahnung Rotary burrs cylinder with endcut	5205	294
		BC Norm	HSS	C WRC	Frässtifte Walzenrund Rotary burrs ball nosed cylinder	5210	294
		BC Norm	HSS	D KUD	Frässtifte Kugel Rotary burrs ball	5215	295
		BC Norm	HSS	G SPG	Frässtifte Spitzbogen Rotary burrs pointed tree	5230	295
		BC Norm	HSS	L KEL	Frässtifte Rundkegel Rotary burrs ball nosed cone	5250	296
		BC Norm	HSS	M SKM	Frässtifte Spitzkegel Rotary burrs cone	5255	296
					Sortimente Sets	5902	297
HM Frässtifte / TC Rotary burrs							
		8033*	HM TC	A ZYA	Frässtifte Zylinder Rotary burrs cylinder	5100 – 5104	302
		8033*	HM TC	B ZYAS	Frässtifte Zylinder mit Stirnverzahnung Rotary burrs cylinder with endcut	5105 – 5109	303
		8033*	HM TC	C WRC	Frässtifte Walzenrund Rotary burrs ball nosed cylinder	5110 – 5114	304
		8033*	HM TC	D KUD	Frässtifte Kugel Rotary burrs ball	5115 – 5119	305
		8033*	HM TC	E TRE	Frässtifte Tropfen Rotary burrs oval	5120 – 5124	306
		8033*	HM TC	F RBF	Frässtifte Rundbogen Rotary burrs ball nosed tree	5125 – 5129	307
		8033*	HM TC	G SPG	Frässtifte Spitzbogen Rotary burrs pointed tree	5130 – 5134	308
		8033*	HM TC	H FLH	Frässtifte Flamme Rotary burrs flame	5135 – 5136	309
		8033*	HM TC	J KSJ	Frässtifte Kegel 60° Rotary burrs countersink 60°	5140 – 5141	309





































	DIN	Qualität Quality	Form Shape	Bezeichnung Description	Code	Seite Page
HM Frässtifte / TC Rotary burrs						
		8033*	HM TC	K KSK Frässtifte Kegel 90° Rotary burrs countersink 90°	5145 – 5146	310
		8033*	HM TC	L KEL Frässtifte Rundkegel Rotary burrs ball nosed cone	5150 – 5154	311
		8033*	HM TC	M SKM Frässtifte Spitzkegel Rotary burrs cone	5155 – 5156	310
		8033*	HM TC	N WKN Frässtifte Winkel Rotary burrs inverted cone	5160 – 5161	312
		BC Norm	HM TC	RX Frässtift Radius Rotary burr radius	5170	312
		8033*	HM TC	Kleinfrässtifte, Schaft 3 mm Miniature carbide rotary burrs, shank 3 mm	5100 – 5160	313
		8033*	HM TC	Frässtifte, Schaft 8 mm Rotary burrs, shank 8 mm	5100 – 5151	314
		8033*	HM TC	Frässtifte, extra lang, Schaft 6 mm Rotary burrs, extra long, shank 6 mm	5100 – 5151	315
				Sortimente + Display Sets + display	5900 – 5905	316 – 317

* Frässtifte ähnlich DIN 8033 / * Rotary burrs similar to DIN 8033















	Bezeichnung Description	Code	Seite Page
Schmierstoffe / Lubricants			
	 ALLROUND Schneidpaste ALLROUND cutting paste	9690 BP-20 BP-40 BP-120 BP-750	320
	 HIGH PERFORMANCE Schneidwachs HIGH PERFORMANCE cutting wax	9690 BW-300	321
	 HIGH PERFORMANCE Schneidgel HIGH PERFORMANCE cutting gel	9690 BG-120	322
	 ALLROUND Schneidöl ALLROUND cutting oil	9690 BO-250	323
	 HIGH PERFORMANCE Schneidschaum HIGH PERFORMANCE cutting foam	9690 BS-400	324

	DIN	Bezeichnung Description	Code	Seite Page
Bohrfutter und Zubehör / Drill chucks and accessories				
		Zahnkranz-Bohrfutter Key type drill chucks	1465 1466	328
		Schlüssellose Bohrfutter Keyless drill chucks	1467 – 1469	329 – 330
		Präzisions-Schnellspannbohrfutter Precision Quick-Action drill chucks	1458 1459	331
		Zubehör für Bohrfutter Accessories for drill chucks	1465	329
	238	Kegeldorne Drill chuck arbors	1463	332
	2185	Reduzierhülsen Reduction sleeves	1460	332
	2187	Verlängerungshülsen Extension sleeves	1461	333
	317	Austreiber Drill drifts	1462	333
	Typ Type	Bezeichnung Description	Code	Seite Page
Schlag- und Drehbohrer / Percussion and rotary drill bits				
		Steinbohrer HM, Standardausführung Masonry drill bits, standard version	2100 2150	336
		Schlagbohrer HM Percussion drill bits, TCT	2260 2261	337
	LASER	Premium Betonbohrer HM Premium concrete drill bits, TCT	2250 – 2252	338
	GRANIT	Granitbohrer HM Granite drill bits, TCT	2280	339
	MULTI-LASER	Mehrzweckbohrer / Fliesenbohrer, HM Multi-Purpose / Ceramic drills, TCT	2270	340
		Glas- und Fliesenbohrer HM Glass and ceramic drill bits, TCT	2700	341
	T4	Glas- und Fliesenbohrer, 4 HM-Schneiden Glass / Ceramic drill bits, 4 carbide cutting edges	2710	341
Hammerbohrer / Hammer drill bits				
	QX-4	Hammerbohrer SDS-plus, 4-Schneiden, Vollhartmetallkopf, PGM-Prüfzeichen Hammer drill bits SDS-plus, 4 cutting edges, full carbide head, PGM certification-mark	2612	344 – 346
	4-X	Hammerbohrer SDS-plus, 4 HM-Schneiden Hammer drill bits SDS-plus, 4 carbide cutting edges	2615	347 – 348
	X-TREME	Hammerbohrer SDS-plus, 2 HM-Schneiden, PGM Prüfzeichen Hammer drill bits SDS-plus, 2 carbide cutting edges, PGM certification-mark	2610	349 – 351

	Typ Type	Bezeichnung Description	Code	Seite Page
Hammerbohrer / Hammer drill bits				
		Hammerbohrer SDS-plus, 2 HM-Schneiden Hammer drill bits SDS-plus, 2 carbide cutting edges	2590	352 – 353
	 	Hammerbohrer SDS-max, PGM-Prüfzeichen Hammer drill bits SDS-max, PGM certification-mark	2620	354 – 355
Meißel / Chisels				
	  	Meißel SDS-plus / Meißel SDS-max Chisels SDS-plus / Chisels SDS-max	2650 2660	356 – 357
Diamantbohrer / Diamond drill bits				
	 DIAMANT M14	Diamant-Fliesenbohrer M14 für Winkelschleifer Diamond tile drill bits M14 for angle grinders	2702	360
	 DIAMANT	Diamant-Fliesenbohrer mit 6-kant Schaft Diamond tile drill bits with hex-shank	2701	361
	 BASIC	Diamant-Fliesenbohrer mit 3-Flächenschaft Diamond tile drill bits with triangle-shank	2703	362
		Zubehör für Diamantbohrer Accessories for diamond drill bits	2701	363
Diamant-Dosensenker / Diamond core drills				
	 PROFI	Diamant-Dosensenker Diamond core drills	2720	364
		Zubehör für Diamant-Dosensenker Accessories for diamond core drills	2301 2302	364
Diamant-Trennscheiben / Diamond cutting tools				
	 PROFI	Diamant-Trennscheiben TURBO mit Kühllöchern Diamond cutting discs TURBO, with cooling slots	2730	366
	 BASIC	Diamant-Trennscheiben TURBO Diamond cutting discs TURBO	2735	366
	 BASIC	Diamant-Trennscheiben Diamond cutting discs	2740	367
	 PROFI	Diamant-Trennscheiben CERAMIC Diamond cutting discs CERAMIC	2745	367
Diamantschleifteller / Diamond cup wheels				
	 PROFI	Diamant-Schleifteller Diamond cup wheels	2750	368

	Typ Type	Bezeichnung Description	Code	Seite Page
Spiralbohrer und Senker / Wood drill bits and countersinks				
		Holzspiralbohrer Brad point wood drill bits	3100	372
		Holzspiralbohrer, lange Ausführung Brad point wood drill bits, long version	3101	372
		INDUSTRIE HSS-G Premium Holzspiralbohrer Industrieausführung HSS-G premium wood drill bits industrial type	3110	373
		Aufstecksenker WS Shell drill countersinks	3450	374
		Senker (Krauskopf) DIN 6446 B Countersinks DIN 6446 B	3700	374
Forstnerbohrer + diverse / Forstner bits + miscellaneous bits				
		Forstnerbohrer Forstner bits	3250	375
		Kunstbohrer HM Cylinder boring bits, TCT	3261	376
		Scheibenschneider / Zapfenfräser DIN 7489 Tenon dowel / Plug cutters DIN 7489	3650	377
Schalungsbohrer + Flachfräsbohrer / Frame work drills + flat bits				
		Schalungsbohrer Rundschaft Frame work drills with cylindrical shank	3120	378
		SDS SDS-plus Schalungsbohrer Frame work drills with SDS-plus shank	3130	379
		Flachfräsbohrer Machine flat bits	3410 3411	383
Schlangenbohrer / Auger bits				
		LEWIS Schlangenbohrer mit 6-kant Schaft Auger bits with hexagon shank	3200	380 – 381
		LEWIS SDS SDS-plus Schlangenbohrer Auger bits with SDS-plus shank	3210	382
Lochsägen / Hole saws				
		Bi-Metall Lochsägen HSS Bi-Metal hole saws HSS	1900	388 – 389
		VA-CUT® Premium Bi-Metall Lochsägen HSS-E (Co8) kobaltlegiert Premium Bi-Metal hole saws HSS-E (Co8) cobalt alloyed	1901	390 – 391
		Zubehör für Lochsägen Accessories for hole saws	1910 1911	387
		MULTI-CUT Mehrzweck-Lochsägen HM Multi-Purpose hole saws TCT	1930	392
		Zubehör für Mehrzweck-Lochsägen HM Accessories for Multi-Purpose hole saws TCT	1935 1936	393

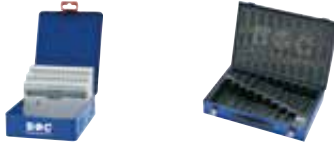
	Typ Type	Bezeichnung Description	Code	Seite Page
Stichsägeblätter / Jigsaw blades				
	Holz und Kunststoff Wood and plastics	Stichsägeblätter mit T-Einnockenschaft Jigsaw blades with T-Shank	1960 – 1963	400 – 402
	Metall Metal	Stichsägeblätter mit T-Einnockenschaft Jigsaw blades with T-Shank	1964 – 1965	403 – 404
	Spezialanwendungen Special applications	Stichsägeblätter mit T-Einnockenschaft Jigsaw blades with T-Shank	1966	405
		Sortimente Sets	1990 – 1991	405
Säbelsägeblätter / Reciprocating saw blades				
	Holz und Kunststoff Wood and plastics	Säbelsägeblätter mit Universalschaft Reciprocating (Sabre) saw blades with universal shank	1970	406
	Holz und Grünholz Wood and green wood	Säbelsägeblätter mit Universalschaft Reciprocating (Sabre) saw blades with universal shank	1970	406
	Metall Metal	Säbelsägeblätter mit Universalschaft Reciprocating (Sabre) saw blades with universal shank	1971	407
	Holz und Metall Wood and metal	Säbelsägeblätter mit Universalschaft Reciprocating (Sabre) saw blades with universal shank	1971 – 1974	408
Säbelsägeblätter / Reciprocating saw blades				
	Spezialanwendungen Special applications	Säbelsägeblätter mit Universalschaft Reciprocating (Sabre) saw blades with universal shank	1973	409
	Dämmstoffe Insulation materials	Säbelsägeblätter mit Universalschaft Reciprocating (Sabre) saw blades with universal shank	1974	409
Druckluftsägeblätter / Compressed air saw blades				
		Druckluftsägeblätter für pneumatische und elektrische Maschinen Compressed air saw blades for pneumatic and electric car-body saws	1975	409
Handsägeblatt / Hack saw blade				
		Handsägeblatt Hack saw blade	1980	405
Schraublochstanzen und Zubehör / Screw-hole punches and accessories				
		Schraublochstanzen mit 3-Punkt-Anschnitt Screw-hole punches with 3-point cutting tip	1915	412
		Ersatzschrauben für Schraublochstanzen Replacement screws for screw-hole punches	1916	413
Schrauber-Bits + Halter 1/4" Antrieb / Screwdriver-bits and holders 1/4" drive				
		Schrauber-Bits 1/4" Screwdriver-bits 1/4"	6100 – 6230	417 – 424
		Schrauber-Bits 1/4", TiN-beschichtet Screwdriver-bits 1/4" TiN-coated	6121 – 6141	417 – 420
		Farbring Schrauber-Bits 1/4" Colour Ring screwdriver-bits 1/4"	6123 – 6143	418 – 421

	Bezeichnung Description	Code	Seite Page
Schrauber-Bits + Halter 1/4" Antrieb / Screwdriver-bits and holders 1/4" drive			
	 Sortimente Sets	6900	424
	 Bithalter für Schrauber-Bits 1/4" Bitholders for screwdriver-bits 1/4"	6300 – 6330	425
Halter 1/4" Antrieb / Holders 1/4" drive			
	 Winkel-Vorsätze für 1/4" Bits und für Bohrer L-shaped drivers for 1/4" bits and for drills	6350 6351	426
Steckschlüssel + Adapter 1/4" Antrieb / Sockets + adaptors 1/4" drive			
	 Steckschlüsseleinsätze 1/4", 45 mm Länge Sockets 1/4", 45 mm length	6500	427
	 Steckschlüsseleinsätze 1/4", 65 mm Länge Sockets 1/4", 65 mm length	6500-65	427
	 Steckschlüsseleinsätze 1/4", unmagnetisch Sockets 1/4", non-magnetic	6501	428
	 Steckschlüsseleinsätze mit Federring für rostfreie Schrauben Sockets with spring for stainless screws	6502	428
	 Eindrehwerkzeug für Stockschrauben Fixing-tool for setting hanger bolts	6505	428
	 Adapter Adaptors	6400 6645-1/4"	429
Schrauber-Bits + Zubehör 5/16" Antrieb / Screwdriver-bits + accessories 5/16" drive			
	 Schrauber-Bits 5/16" Sechskant Screwdriver-bits 5/16" hexagon	6710 – 6720	430 – 431
Schrauber-Bits + Zubehör 10 mm Antrieb / Screwdriver-bits and holders 10 mm drive			
	 Schrauber-Bits 10 mm Sechskant Screwdriver-bits 10 mm hexagon	6614 – 6624	432 – 433
	 Adapter mit Kugel für 10 mm Sechskant Adaptors with ball for 10 mm hexagon	6645	433
Leerkassetten / Empty boxes			
	 ABS-Boxen ABS-Boxes	0081	435
	 Industriekassetten für Spiralbohrer DIN 338 Metal-Boxes for twist drills DIN 338	0080	436
Verkaufsschränke / Drill cabinets			
	 Verkaufsschränke für Spiralbohrer DIN 338 Drill cabinets for twist drills DIN 338	0130	437



QuadroPack mit Rundlochung
QuadroPack with round hole



QuadroPack
QuadroPack



DrehPack mit Rundlochung
TwistPack with round hole



DrehPack
TwistPack



Hülse mit Eurolochung
Tube with euroslot



Tasche mit Eurolochung
Wallet with euroslot

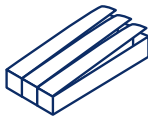

SplitPack
SplitPack



Kunststoffbox mit Eurolochung
Plasticbox with euroslot



Kunststoffbox
Plasticbox



Clip mit Eurolochung
Clip with euroslot



Gewindeclip mit Eurolochung
Threadclip with euroslot

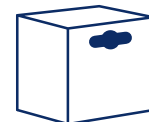

Kartonverpackung mit Eurolochung
Cartonbox with euroslot



Pappkarte mit Eurolochung
Cartoncard with euroslot



Werksverpackung
Bulk packaging



SPIRALBOHRER
TWIST DRILLS



	Schneidstoff Cutting material	Typ Type				
	HSS-G	-	1301 Seite / Page 95		1300 Seite / Page 94	
	HSS-E Co5	-	1310 Seite / Page 95			
DIN 333	HSS-G	A			1600 Seite / Page 94	
DIN 338	HSS-R	N			1100 Seite / Page 34 – 38	
	HSS-G	N	1122 Seite / Page 48 – 50	1121 Seite / Page 45 – 47	1120 Seite / Page 39 – 43	
	HSS-G OX	N		1119 Seite / Page 45 – 46		
	HSS-G TiN	N	1123 / 1124 Seite / Page 48 – 52		1130 Seite / Page 44	
	HSS-G	T-Step	1202 Seite / Page 56 – 57			
	HSS-G	W	1127 Seite / Page 60			
	HSS-G	H	1128 Seite / Page 61			
	HSS-G	HK	1131 Seite / Page 62			
	HSS-E Co5	VA/Ti N	1141 Seite / Page 68 – 69		1140 Seite / Page 63 – 66	
	HSS-E Co5 TiALN	VA/Ti	1143 Seite / Page 68 – 69			
	HSS-E Co5	U-TL	1142 Seite / Page 70 – 71			
	HSS-E Co5 TiALN	U-TL	1144 Seite / Page 70 – 71			
	HSS-E Co5	N-Z3	1149 Seite / Page 72 – 73			
	HSS-E Co5	T-Step	1203 Seite / Page 67			
	HSS-E Co8	N-HD	1147 Seite / Page 74 – 75			
	HSS-E Co8	N-HD	1148 Seite / Page 74 – 75			
	HSS-E Co8	HDX	1508 Seite / Page 76 – 77			
	VHM / SC TiALN	N	1502 Seite / Page 106 – 107			
DIN 340	HSS-R	N			1340 Seite / Page 78	
	HSS-G	N	1353 Seite / Page 80		1350 Seite / Page 79	
	HSS-E Co5	N	1360 Seite / Page 81			
	HSS-E Co5 TiN	N	1361 Seite / Page 81			
	HSS-E Co5	U-TL	1362 Seite / Page 82			
DIN 341	HSS	N	1455 Seite / Page 101			
DIN 345	HSS	N	1451 Seite / Page 98 – 99		1450 Seite / Page 96 – 97	
	HSS-E Co5	N	1470 Seite / Page 100			
DIN 1869	HSS-G	U-TL N	1410 Seite / Page 84		1400 Seite / Page 83	
	HSS-E Co5	U-TL	1420 Seite / Page 85			
DIN 1897	HSS-G	N	1255 Seite / Page 90		1250 Seite / Page 89	
	HSS-G	T-Step	1204 Seite / Page 58			
	HSS-E Co5	N	1265 Seite / Page 92		1260 Seite / Page 91	
	HSS-E Co5 TiN	N	1266 Seite / Page 92			
DIN 6539	VHM / SC TiALN	N	1504 Seite / Page 108 – 109			
DIN 8037	HSS-HM / TCT	N	1500 Seite / Page 110			



TECHNISCHE DETAILS
TECHNICAL DETAILS

Typ
N HSS
G



Spiralbohrer für normalharte Werkstoffe wie allgemeine Baustähle, NE-Metalle und Gusseisen.

Twist drill for materials with normal tensile strength, e.g. general structural steels, non ferrous materials and cast iron.

Typ
N VA
INOX



Spiralbohrer mit höherer Warmhärtebeständigkeit, zum Bohren von rost-, säure- und hitzebeständigen Stählen.

Twist drill with higher heat resistance, for drilling stainless steels and heat resistant steels.

Typ
VA/TI VA
INOX



Spezialbohrer mit hoher Bruchsicherheit durch verstärkte Kerndicke. Für Werkstoffe mit einer Festigkeit bis 1.200 N/mm².

Special twist drill with high security against fracture due to reinforced web thickness. Suitable for materials with tensile strength up to 1.200 N/mm² (38 HRC).

Typ
N-HD VA
INOX



Stabiler Spezialbohrer mit 8 % Kobaltlegierung. Hierdurch extrem ausgeprägte Warmhärtebeständigkeit. Für feste und hochfeste Werkstoffe mit einer Festigkeit bis 1.400 N/mm².

Heavy-Duty Ausführung!

Stable high performance twist drill with 8 % cobalt alloy, thereby high warm hardness durability. Suitable for materials with tensile strength up to 1.400 N/mm² (44 HRC).

Heavy-Duty Version!

Typ
U-TL TIEFLOCH
DEEPPHOLE
Version



Mehrbereichsbohrer mit parabolisch geformter Spannunt zur besseren Spanabfuhr. Für Werkstoffe mit einer Festigkeit bis 1.200 N/mm².

Deckt in weiten Bereichen Typ N, H und W ab.

Multigrade twist drill with parabolic flute for improved chip removal. Suitable for materials with tensile strength up to 1.200 N/mm² (38 HRC).

Covers types N, H and W for a wide range of application.

Z3 Typ
N



Industrie Spiralbohrer mit 3-Schneidengeometrie für bis zu 60% höheren Vorschub im Vergleich zu Bohrern mit 2 Schneiden. Bei Einsatz in CNC- oder NC-Maschinen Bohrungsqualitäten bis IT 9 möglich. Universell einsetzbar in Baustahl, unlegiertem und legiertem Stahl < 1.000 N/mm², sowie Aluminium (Knet- und Gusslegierungen).

Twist drill for industrial use with 3 cutting edges for up to 60% higher feed rate compared to twist drills with 2 cutting edges. Used in CNC machines drilling qualities up to IT 9 are possible. Universal use in structural steel, unalloyed and alloyed steel < 1,000 N/mm² (32,2 HRC), as well as aluminum (wrought and cast alloys).

Typ
LN LINKS
LEFTHAND
LH



Linksschneidender Spiralbohrer für normalharte Werkstoffe wie allgemeine Baustähle, NE-Metalle und Gusseisen.

Left-hand cutting twist drill for materials with normal tensile strength, e.g. in general structural steels, non ferrous materials and cast iron.



Typ
W ALU



Spiralbohrer für weiche, langspanende und zähe Werkstoffe wie Aluminium, Kupfer oder weiche Kunststoffe.

Twist drill for long chipping and tough materials such as aluminium, copper or soft plastic.

Typ
H MESSING
BRASS



Spiralbohrer für harte, kurzspanende, spröde und zähartige Werkstoffe wie Stahl, Hartkunststoff, Plexiglas oder Schichtpresstoffe.

Twist drill for hard, short chipping, brittle and tough materials such as steel, hard plastics, acrylic glass or laminate.

Typ
HK Plastics
PVC



Spiralbohrer für Kunststoffe (Duroplaste).

Twist drill for synthetic materials (Thermoset).

TURBO
STEP Ø > 2,5mm



Spiralbohrer mit innovativer Stufengeometrie für beste Bohrergebnisse bei maximaler Geschwindigkeit. Geeignet für Stahl bis 1.000 N/mm² Festigkeit, Gusswerkstoffe, Aluminium, Kunststoffe, Hart- und Weichholz.

Twist drill with innovative geometry for the best drilling results at maximum cutting speed. Suitable for steels up to 1.000 N/mm² (32,2 HRC) tensile strength, cast materials, aluminium, plastics, hard- and softwood.

TURBO
STEP INOX Ø > 2,5mm



Spiralbohrer mit innovativer Stufengeometrie für beste Bohrergebnisse bei maximaler Geschwindigkeit. Geeignet für Stahl und Edelstahl bis 1.200 N/mm² Festigkeit, Gusswerkstoffe, Aluminium, Kunststoffe, Hart- und Weichholz.

Twist drill with innovative geometry for the best drilling results at maximum cutting speed. Suitable for steels and stainless steels up to 1.200 N/mm² (~38 HRC) tensile strength, cast materials, aluminium, plastics, hard- and softwood.

Typ
HDX HARDDOX
500



Spezialbohrer mit extrem ausgeprägter Warmhärtebeständigkeit. Sehr stabil durch extra kurze Spirale und verstärkten Kern.

Special twist drill with extremely high heat resistance. Very stable due to extra short spiral and reinforced core.

VHM
SC DIN
6539



Stabiler Bohrer aus Vollhartmetall zum Bohren von hochfesten Stählen, Cr-Ni-Stählen, Hartguss, Grauguss, Stahlguss, Mn-Hartstahl, Bronze, Aluminium mit hohem Siliziumanteil und abrasiven Werkstoffen.

VHM
SC DIN
338



Stable solid carbide twist drill for drilling heat resistant steels, high carbon steel castings, grey cast iron, cast steels, manganese steels, bronze, aluminium with high percentage of silicium and for machining abrasive materials.

VHM
SC Z3



Schweißpunktbohrer aus Vollhartmetall mit 3 Schneiden. Zum Ausbohren von Schweißpunkten in hochfesten Blechen mit einer Festigkeit bis 1.800 N/mm². Deutlich schneller und langlebiger als vergleichbare Produkte mit 2 Schneiden. Spot weld drill made of solid carbide with 3 cutting edges. For drilling out welding points in high-strength sheets up to 1.800 N/mm² (~ 52 HRC) tensile strength. Significantly faster and more durable than comparable products with 2 cutting edges.



TECHNISCHE DETAILS
TECHNICAL DETAILS

DIN	338	338	338	338	338	338	338	338	338	338
Typ Type	N	N	N	N	N	N	N	N	N	N - LH
Schneidstoff Cutting material	HSS	HSS	HSS	HSS	HSS	HSS	HSS	HSS	HSS	HSS
Bohrtiefe Cutting depth	5xD	5xD	5xD	5xD	5xD	5xD	5xD	5xD	5xD	5xD
Beschichtung Coating	OX	-	TiN	-	OX	-	TiN	TiN-Tip	-	-
Spitzenwinkel Point angle	118°	118°	118°	118°	118°	118°	118°	118°	118°	118°
Schaft Shank	zyl. cyl.	zyl. cyl.	zyl. cyl.	zyl. cyl.	zyl. cyl.	zyl. cyl.	zyl. cyl.	zyl. cyl.	zyl. cyl.	zyl. cyl.
Bereich Range	0,3 – 20,0 mm	0,5 – 25,0 mm	1,0 – 13,0 mm	0,4 – 25,0 mm	1,0 – 16,0 mm	0,5 – 25,0 mm	1,0 – 13,0 mm	1,0 – 13,0 mm	1,0 – 13,0 mm	1,0 – 13,0 mm
Qualität Quality	★★★★	★★★★	★★★★	★★★★★	★★★★★	★★★★★	★★★★★	★★★★★	★★★★★	★★★★★
Code	1100 1109	1120 1110	1130	1121	1119	1122	1123	1124	1129	
Seite Page	34 – 38	39 – 43	44	45 – 47	45 – 46	48 – 50	48 – 49	51 – 52	53	
P	1.1 – 2.1	☉	☉	☉	☉	☉	☉	☉	☉	☉
	3.1 – 4.1			☉	☉	☉	☉	☉	☉	☉
	5.1									
M	1.1 – 2.1									
	3.1 – 4.1									
K	1.1 – 4.2		☉	☉	☉	☉	☉	☉	☉	☉
N	1.1 – 1.6	☉	☉	☉	☉	☉	☉	☉	☉	☉
	2.1	☉	☉	☉	☉	☉	☉	☉	☉	☉
	2.2	☉	☉	☉	☉	☉	☉	☉	☉	☉
	2.3	☉	☉	☉	☉	☉	☉	☉	☉	☉
	2.4	☉	☉	☉	☉	☉	☉	☉	☉	☉
	2.5	☉	☉	☉	☉	☉	☉	☉	☉	☉
	2.6	☉	☉	☉	☉	☉	☉	☉	☉	☉
	2.7									
	2.8									
	3.1									
	3.2									
S	1.1 – 1.3									
	2.1 – 2.6									
H	1.1									
	1.2									
	1.3									
	1.4									
	1.5									

☉ geeignet / suitable ☉ bedingt geeignet / limited suitable









TECHNISCHE DETAILS
TECHNICAL DETAILS

Anwendungsempfehlung für Spiralbohrer Application recommendation for twist drills

338	338	338	338	338	338	338	338	338	338	338
Turbo	Turbo-Step	W	H	HK	N	VA/Ti	VA/Ti	U-TL	U-TL	N-Z3
HSS	HSS	HSS	HSS	HSS	HSS-E Co5	HSS-E Co5	HSS-E Co5	HSS-E Co5	HSS-E Co5	HSS-E Co5
5xD	5xD	5xD	5xD	5xD	5xD	5xD	5xD	5xD	5xD	5xD
-	-	-	-	-	-	-	TiALN	-	TiALN	-
118°	118°	130°	118°	80°	135°	130°	130°	130°	130°	130°
3-kant 3-flat	3-kant 3-flat	zyl. cyl.	zyl. cyl.	zyl. cyl.	zyl. cyl.	zyl. cyl.	zyl. cyl.	zyl. cyl.	zyl. cyl.	zyl. cyl.
1,0 – 13,0 mm	1,0 – 13,0 mm	2,0 – 13,0 mm	2,0 – 13,0 mm	2,0 – 10,0 mm	1,0 – 20,0 mm	0,6 – 16,0 mm	2,0 – 16,0 mm	2,0 – 13,0 mm	2,0 – 13,0 mm	2,0 – 13,0 mm
★★★★★	★★★★★	★★★★★	★★★★★	★★★★★	★★★★	★★★★★	★★★★★	★★★★★	★★★★★	★★★★★
1201	1202	1127	1128	1131	1140	1141	1143	1142	1144	1149
54 – 55	56 – 57	60	61	62	63 – 66	68 – 69	68 – 69	70 – 71	70 – 71	72 – 73





































































































































































geeignet / suitable bedingt geeignet / limited suitable





									
DIN	338	338	338	338	340	340	340	340	340
Typ Type	Turbo-Step	N-HD	N-HD	HDX	N	N	N	N	N
Schneidstoff Cutting material	HSS-E Co5	HSS-E Co8	HSS-E Co8	HSS-E Co8	HSS	HSS	HSS	HSS-E Co5	HSS-E Co5
Bohrtiefe Cutting depth	5xD	5xD	5xD	3xD	10xD	10xD	10xD	10xD	10xD
Beschichtung Coating	-	-	TiALN	ZRN+	OX	-	-	-	TiN
Spitzenwinkel Point angle	118°	130°	130°	130°	118°	118°	118°	130°	130°
Schaft Shank	3-kant 3-flat	zyl. cyl.	zyl. cyl.	zyl. cyl.	zyl. cyl.	zyl. cyl.	zyl. cyl.	zyl. cyl.	zyl. cyl.
Bereich Range	1,0 – 13,0 mm	1,0 – 13,0 mm	2,0 – 13,0 mm	1,0 – 13,0 mm	2,0 – 13,0 mm	1,0 – 16,0 mm	0,7 – 13,0 mm	2,0 – 13,0 mm	2,0 – 13,0 mm
Qualität Quality	★★★★★	★★★★★	★★★★★	★★★★★	★★★	★★★	★★★★★	★★★★★	★★★★★
Code	1203	1147	1148	1508	1340	1350	1353	1360	1361
Seite Page	67	74 – 75	74 – 75	76 – 77	78	79	80	81	81
P	1.1 – 2.1								
	3.1 – 4.1								
	5.1								
M	1.1 – 2.1								
	3.1 – 4.1								
K	1.1 – 4.2								
N	1.1 – 1.6								
	2.1								
	2.2								
	2.3								
	2.4								
	2.5								
	2.6								
	2.7								
	2.8								
	3.1								
3.2									
4.1									
4.2									
S	1.1 – 1.3								
	2.1 – 2.6								
H	1.1								
	1.2								
	1.3								
	1.4								
	1.5								

geeignet / suitable bedingt geeignet / limited suitable

TECHNISCHE DETAILS
TECHNICAL DETAILS

										
340	1869	1869	1869	-	-	-	1897	1897	1897	1897
U-TL	N	U-TL	U-TL	N	N	N	N	N	Turbo-Step	N
HSS-E Co5	HSS	HSS	HSS-E Co5	HSS	HSS	HSS	HSS	HSS	HSS	HSS-E Co5
10xD	15 – 25xD	15 – 25xD	15 – 25xD	-	-	-	3xD	3xD	3xD	3xD
-	-	-	-	-	-	-	-	-	-	-
130°	118°	130°	130°	118°	118°	118°	118°	118°	118°	135°
zyl. cyl.	zyl. cyl.	zyl. cyl.	zyl. cyl.	zyl. cyl.	1/4" 6-kant 1/4" hex	zyl. cyl.	zyl. cyl.	zyl. cyl.	3-kant 3-flat	zyl. cyl.
2,0 – 13,0 mm	2,0 – 13,0 mm	2,0 – 13,0 mm	2,0 – 13,0 mm	2,5 – 6,8 mm	1,0 – 10,2 mm	3,0 – 6,0 mm	2,0 – 13,0 mm	2,0 – 13,0 mm	13,5 – 16,0 mm	2,0 – 13,0 mm
★★★★★	★★★★★	★★★★★	★★★★★	★★★★★	★★★★	★★★	★★★	★★★	★★★★★	★★★★
1362	1400	1410	1420	1440	1104	1200	1250	1255	1204	1260
82	83	84	85	86	87	88	89	90	58	91
										
										
										
										
										
										
										
										
										
										
										
										
										
										

 geeignet / suitable  bedingt geeignet / limited suitable



TECHNISCHE DETAILS
TECHNICAL DETAILS































































Anwendungsempfehlung für Spiralbohrer

Application recommendation for twist drills

DIN	1897	1897	-	-	-	333	345	345	345
Typ Type	N	N	N	N	N	Form A	N	N	N
Schneidstoff Cutting material	HSS-E Co5	HSS-E Co5	HSS	HSS	HSS-E Co5	HSS	HSS	HSS	HSS-E Co5
Bohrtiefe Cutting depth	3xD	3xD	-	-	-	-	5xD	5xD	5xD
Beschichtung Coating	-	TiN	-	-	-	-	-	-	-
Spitzenwinkel Point angle	130°	130°	118°	118°	130°	118°	118°	118°	130°
Schaft Shank	zyl. cyl.	zyl. cyl.	zyl. cyl.	zyl. cyl.	zyl. cyl.	zyl. cyl.	MK MT	MK MT	MK MT
Bereich Range	2,0 – 13,0 mm	2,0 – 13,0 mm	2,0 – 6,0 mm	2,0 – 8,0 mm	3,2 – 5,2 mm	0,8 – 10,0 mm	10,0 – 60,0 mm	6,0 – 100,0 mm	10,0 – 50,0 mm
Qualität Quality	★★★★★	★★★★★	★★★	★★★★★	★★★★★	★★★	★★★	★★★★★	★★★★★
Code	1265	1266	1300	1301	1310	1600	1450	1451	1470
Seite Page	92	92	94	95	95	93	96 – 97	98 – 99	100
P	1.1 – 2.1	☉	☉	☉	☉	☉	☉	☉	☉
	3.1 – 4.1	☉	☉		☉	☉		☉	☉
	5.1	☉	☉			☉			☉
M	1.1 – 2.1	☉	☉			☉			☉
	3.1 – 4.1	☉	☉						☉
K	1.1 – 4.2	☉	☉	☉	☉	☉	☉	☉	☉
	1.1 – 1.6	☉		☉	☉	☉	☉	☉	☉
N	2.1	☉	☉	☉	☉	☉	☉	☉	☉
	2.2	☉	☉	☉	☉	☉	☉	☉	☉
	2.3	☉	☉	☉	☉	☉	☉	☉	☉
	2.4	☉	☉	☉	☉	☉	☉	☉	☉
	2.5	☉	☉	☉	☉	☉	☉	☉	☉
	2.6	☉	☉	☉	☉	☉	☉	☉	☉
	2.7								
	2.8								
	3.1								
	3.2								
	4.1								
4.2	☉		☉	☉	☉	☉	☉	☉	☉
S	1.1 – 1.3		☉			☉			
	2.1 – 2.6								
H	1.1								
	1.2								
	1.3								
	1.4								
	1.5								

☉ geeignet / suitable ☉ bedingt geeignet / limited suitable

TECHNISCHE DETAILS
TECHNICAL DETAILS

			
341	338	6539	8037
N	N	N	H
HSS	VHM SC	VHM SC	HSS-HM HSS-TCT
10xD	5xD	3xD	4xD
-	TiALN	TiALN	-
118°	118°	118°	118°
MK MT	zyl. cyl.	zyl. cyl.	zyl. cyl.
10,0 – 50,0 mm	3,0 – 13,0 mm	1,0 – 13,0 mm	2,5 – 13,0 mm
★★★★★	★★★★★	★★★★★	★★★★★
1455	1502	1504	1500
101	106 – 107	108 – 109	110
			
			
			
			
			
			
			
			
			
			
			
			
			
			
			
			
			
			

 geeignet / suitable  bedingt geeignet / limited suitable



Spiralbohrer DIN 338 HSS rollgewalzt

Twist drills DIN 338 HSS roll forged

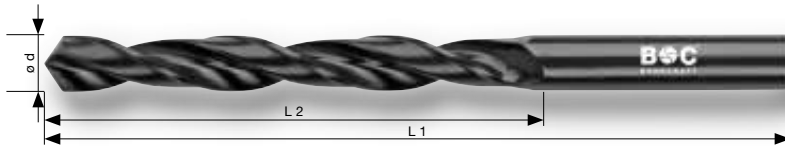

Code 1100



Code	P			M	K	N			S
	1.1 - 2.1	3.1 - 4.1	5.1	1.1 - 4.1	1.1 - 4.2	1.1 - 1.6	2.1 - 2.6	4.2	1.1 - 2.6
1100	☉					☉	☉	☉	

Spanlos hergestellter Spiralbohrer, dadurch erhöhte Elastizität und Bruchsicherheit. Geeignet für robuste Bohrarbeiten in normalharten Werkstoffen sowie NE-Metallen.



Twist drill made in a metal forging process, thereby increasing of elasticity and breakage resistance. Suitable for robust drilling work in normal materials and non-ferrous metals.

Ø d1 mm	L 1 mm	L 2 mm		Artikel-Nr. Part-No.		Artikel-Nr. Part-No.
0,30	19	3	10	1100 01 00030	-	-
0,40	20	5	10	1100 01 00040	-	-
0,50	22	6	10	1100 01 00050	-	-
0,60	24	7	10	1100 01 00060	-	-
0,70	28	9	10	1100 01 00070	-	-
0,80	30	10	10	1100 01 00080	-	-
0,90	32	11	10	1100 01 00090	-	-
1,00	34	12	10	1100 01 00100	3	1100 07 30100
1,10	36	14	10	1100 01 00110	-	-
1,20	38	16	10	1100 01 00120	-	-
1,25	38	16	10	1100 01 00125	-	-
1,30	38	16	10	1100 01 00130	-	-
1,40	40	18	10	1100 01 00140	-	-
1,50	40	18	10	1100 01 00150	3	1100 07 30150
1,60	43	20	10	1100 01 00160	-	-
1,70	43	20	10	1100 01 00170	-	-
1,75	46	23	10	1100 01 00175	-	-
1,80	46	23	10	1100 01 00180	-	-
1,90	46	23	10	1100 01 00190	-	-
2,00	49	24	10	1100 01 00200	3	1100 07 30200
2,10	49	24	10	1100 01 00210	-	-
2,20	53	27	10	1100 01 00220	-	-
2,25	53	27	10	1100 01 00225	-	-
2,30	53	27	10	1100 01 00230	-	-
2,40	57	30	10	1100 01 00240	-	-
2,50	57	30	10	1100 01 00250	3	1100 07 30250
2,60	57	30	10	1100 01 00260	-	-
2,70	61	33	10	1100 01 00270	-	-
2,75	61	33	10	1100 01 00275	-	-
2,80	61	33	10	1100 01 00280	-	-
2,90	61	33	10	1100 01 00290	-	-
3,00	61	33	10	1100 01 00300	3	1100 07 30300
3,10	65	36	10	1100 01 00310	3	1100 07 30310
3,20	65	36	10	1100 01 00320	3	1100 07 30320
3,25	65	36	10	1100 01 00325	-	-
3,30	65	36	10	1100 01 00330	3	1100 07 30330
3,40	70	39	10	1100 01 00340	-	-
3,50	70	39	10	1100 01 00350	2	1100 07 20350
3,60	70	39	10	1100 01 00360	-	-
3,70	70	39	10	1100 01 00370	-	-
3,75	70	39	10	1100 01 00375	-	-
3,80	75	43	10	1100 01 00380	-	-
3,90	75	43	10	1100 01 00390	-	-
4,00	75	43	10	1100 01 00400	2	1100 07 20400
4,10	75	43	10	1100 01 00410	2	1100 07 20410
4,20	75	43	10	1100 01 00420	2	1100 07 20420
4,25	75	43	10	1100 01 00425	-	-
4,30	80	47	10	1100 01 00430	-	-
4,40	80	47	10	1100 01 00440	-	-
4,50	80	47	10	1100 01 00450	2	1100 07 20450
4,60	80	47	10	1100 01 00460	-	-
4,70	80	47	10	1100 01 00470	-	-
4,75	80	47	10	1100 01 00475	-	-

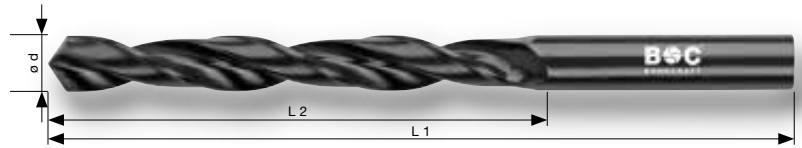
Spiralbohrer DIN 338 HSS rollgewalzt
Twist drills DIN 338 HSS roll forged



Code 1100

Ø d1 mm	L 1 mm	L 2 mm		Artikel-Nr. Part-No.		Artikel-Nr. Part-No.
4,80	86	52	10	1100 01 00480	2	1100 07 20480
4,90	86	52	10	1100 01 00490	-	-
5,00	86	52	10	1100 01 00500	2	1100 07 20500
5,10	86	52	10	1100 01 00510	1	1100 07 00510
5,20	86	52	10	1100 01 00520	1	1100 07 00520
5,25	86	52	10	1100 01 00525	-	-
5,30	86	52	10	1100 01 00530	-	-
5,40	93	57	10	1100 01 00540	-	-
5,50	93	57	10	1100 01 00550	1	1100 07 00550
5,60	93	57	10	1100 01 00560	-	-
5,70	93	57	10	1100 01 00570	-	-
5,75	93	57	10	1100 01 00575	-	-
5,80	93	57	10	1100 01 00580	-	-
5,90	93	57	10	1100 01 00590	-	-
6,00	93	57	10	1100 01 00600	1	1100 07 00600
6,10	101	63	10	1100 01 00610	-	-
6,20	101	63	10	1100 01 00620	-	-
6,25	101	63	10	1100 01 00625	-	-
6,30	101	63	10	1100 01 00630	-	-
6,40	101	63	10	1100 01 00640	-	-
6,50	101	63	10	1100 01 00650	1	1100 07 00650
6,60	101	63	10	1100 01 00660	-	-
6,70	101	63	10	1100 01 00670	-	-
6,75	109	69	10	1100 01 00675	-	-
6,80	109	69	10	1100 01 00680	1	1100 07 00680
6,90	109	69	10	1100 01 00690	-	-
7,00	109	69	10	1100 01 00700	1	1100 07 00700
7,10	109	69	10	1100 01 00710	-	-
7,20	109	69	10	1100 01 00720	-	-
7,25	109	69	10	1100 01 00725	-	-
7,30	109	69	10	1100 01 00730	-	-
7,40	109	69	10	1100 01 00740	-	-
7,50	109	69	10	1100 01 00750	1	1100 07 00750
7,60	117	75	10	1100 01 00760	-	-
7,70	117	75	10	1100 01 00770	-	-
7,75	117	75	10	1100 01 00775	-	-
7,80	117	75	10	1100 01 00780	-	-
7,90	117	75	10	1100 01 00790	-	-
8,00	117	75	10	1100 01 00800	1	1100 07 00800
8,10	117	75	10	1100 01 00810	-	-
8,20	117	75	10	1100 01 00820	-	-
8,25	117	75	10	1100 01 00825	-	-
8,30	117	75	10	1100 01 00830	-	-
8,40	117	75	10	1100 01 00840	-	-
8,50	117	75	10	1100 01 00850	1	1100 07 00850
8,60	125	81	10	1100 01 00860	-	-
8,70	125	81	10	1100 01 00870	-	-
8,75	125	81	10	1100 01 00875	-	-
8,80	125	81	10	1100 01 00880	-	-
8,90	125	81	10	1100 01 00890	-	-
9,00	125	81	10	1100 01 00900	1	1100 07 00900
9,10	125	81	10	1100 01 00910	-	-
9,20	125	81	10	1100 01 00920	-	-
9,25	125	81	10	1100 01 00925	-	-
9,30	125	81	10	1100 01 00930	-	-
9,40	125	81	10	1100 01 00940	-	-
9,50	125	81	10	1100 01 00950	1	1100 07 00950
9,60	133	87	10	1100 01 00960	-	-
9,70	133	87	10	1100 01 00970	-	-
9,75	133	87	10	1100 01 00975	-	-
9,80	133	87	10	1100 01 00980	-	-
9,90	133	87	10	1100 01 00990	-	-
10,00	133	87	10	1100 01 01000	1	1100 07 01000
10,10	133	87	5	1100 01 01010	-	-
10,20	133	87	5	1100 01 01020	1	1100 07 01020
10,25	133	87	5	1100 01 01025	-	-



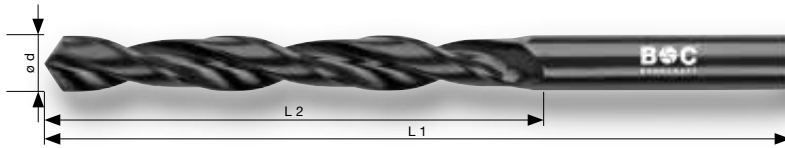

SPIRALBOHRER
TWIST DRILLS

Spiralbohrer DIN 338 HSS rollgewalzt
Twist drills DIN 338 HSS roll forged



Code **1100**

Ø d1 mm	L 1 mm	L 2 mm		Artikel-Nr. Part-No.		Artikel-Nr. Part-No.
10,30	133	87	5	1100 01 01030	-	-
10,40	133	87	5	1100 01 01040	-	-
10,50	133	87	5	1100 01 01050	1	1100 07 01050
10,60	142	94	5	1100 01 01060	-	-
10,70	142	94	5	1100 01 01070	-	-
10,75	142	94	5	1100 01 01075	-	-
10,80	142	94	5	1100 01 01080	-	-
10,90	142	94	5	1100 01 01090	-	-
11,00	142	94	5	1100 01 01100	1	1100 07 01100
11,10	142	94	5	1100 01 01110	-	-
11,20	142	94	5	1100 01 01120	-	-
11,25	142	94	5	1100 01 01125	-	-
11,30	142	94	5	1100 01 01130	-	-
11,40	142	94	5	1100 01 01140	-	-
11,50	142	94	5	1100 01 01150	1	1100 07 01150
11,60	151	101	5	1100 01 01160	-	-
11,70	151	101	5	1100 01 01170	-	-
11,75	151	101	5	1100 01 01175	-	-
11,80	151	101	5	1100 01 01180	-	-
11,90	151	101	5	1100 01 01190	-	-
12,00	151	101	5	1100 01 01200	1	1100 07 01200
12,10	151	101	5	1100 01 01210	-	-
12,20	151	101	5	1100 01 01220	-	-
12,25	151	101	5	1100 01 01225	-	-
12,30	151	101	5	1100 01 01230	-	-
12,40	151	101	5	1100 01 01240	-	-
12,50	151	101	5	1100 01 01250	1	1100 07 01250
12,60	151	101	5	1100 01 01260	-	-
12,70	151	101	5	1100 01 01270	-	-
12,75	151	101	5	1100 01 01275	-	-
12,80	151	101	5	1100 01 01280	-	-
12,90	151	101	5	1100 01 01290	-	-
13,00	151	101	5	1100 01 01300	1	1100 07 01300
13,50	160	108	5	1100 01 01350	-	-
14,00	160	108	5	1100 01 01400	1	1100 07 01400
14,50	169	114	5	1100 01 01450	-	-
15,00	169	114	5	1100 01 01500	-	-
15,50	178	120	5	1100 01 01550	-	-
16,00	178	120	5	1100 01 01600	1	1100 07 01600
16,50	184	125	1	1100 01 01650	-	-
17,00	184	125	1	1100 01 01700	-	-
17,50	191	130	1	1100 01 01750	-	-
18,00	191	130	1	1100 01 01800	-	-
18,50	198	135	1	1100 01 01850	-	-
19,00	198	135	1	1100 01 01900	-	-
19,50	205	140	1	1100 01 01950	-	-
20,00	205	140	1	1100 01 02000	-	-

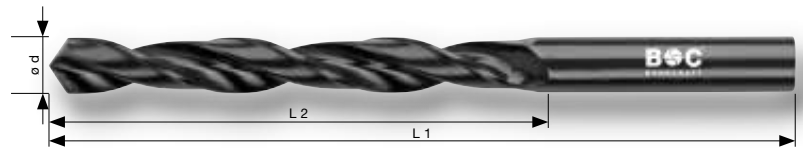

Code 1100

BC ABS-Boxen / BC ABS-Boxes

Bezeichnung Description	Teile Pieces	Inhalt Content	Artikel-Nr. Part-No.
KR 10	19	Ø 1,0 – 10,0 mm x 0,5 mm	1100 13 30019
KR 13	25	Ø 1,0 – 13,0 mm x 0,5 mm	1100 13 30025



BC Grip-Box / BC Grip-Box

Bezeichnung Description	Teile Pieces	Inhalt Content	Artikel-Nr. Part-No.
V 10	19	Ø 1,0 – 10,0 mm x 0,5 mm	1100 14 10119



BC Industrie-Kassetten / BC Metal-Boxes

Bezeichnung Description	Teile Pieces	Inhalt Content	Artikel-Nr. Part-No.
M 10	19	Ø 1,0 – 10,0 mm x 0,5 mm	1100 13 10019
M 13	25	Ø 1,0 – 13,0 mm x 0,5 mm	1100 13 10025
M 24	24	Ø 1,0 – 10,5 mm x 0,5 mm + Ø 3,3 · 4,2 · 6,8 · 10,2 mm	1100 14 10024
M 591	50	Ø 1,0 – 5,9 mm x 0,1 mm	1100 14 10050
M 601	41	Ø 6,0 – 10,0 mm x 0,1 mm	1100 14 10041
M 170	170	Ø 1,0 – 10,0 mm x 0,5 mm Ø 1,0 – 8,0 mm = 10 St. / pcs. Ø 8,5 – 10,0 mm = 5 St. / pcs.	1100 14 10170
M 220	220	Ø 1,0 – 13,0 mm x 0,5 mm + 3,3 / 4,2 mm Ø 1,0 – 8,0 mm = 10 St. / pcs. Ø 8,5 – 13,0 mm = 5 St. / pcs.	1100 14 20220



Kunststoff-Kassetten / Plastic-Boxes

Bezeichnung Description	Teile Pieces	Inhalt Content	Display 	Artikel-Nr. Part-No.
P 6	6	Ø 2 · 3 · 4 · 5 · 6 · 8 mm	18	1100 14 30006
P 65	13	Ø 1,5 – 6,5 mm x 0,5 mm + Ø 3,2 · 4,8 mm	16	1100 14 30013



Runddose / Round-Box

Bezeichnung Description	Teile Pieces	Inhalt Content	Artikel-Nr. Part-No.
RB 10	19	Ø 1,0 – 10,0 mm x 0,5 mm	1100 14 40019



Spiralbohrer DIN 338 HSS rollgewalzt, mit reduziertem Schaft
 Twist drills DIN 338 HSS roll forged, reduced shank

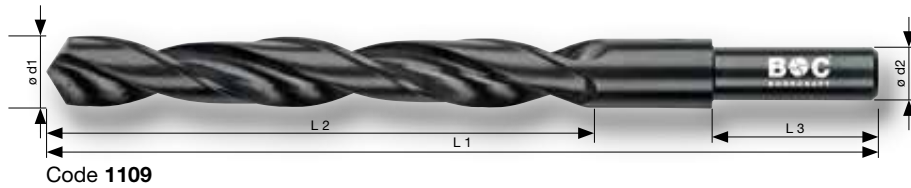

Code 1109

DIN 338	HSS R	OX	Typ N	118°	5xD
-------------------	-----------------	-----------	-----------------	------	------------

Code	P			M	K	N			S
	1.1 - 2.1	3.1 - 4.1	5.1	1.1 - 4.1	1.1 - 4.2	1.1 - 1.6	2.1 - 2.6	4.2	1.1 - 2.6
1109									

Spanlos hergestellter Spiralbohrer, dadurch erhöhte Elastizität und Bruchsicherheit. Geeignet für robuste Bohrarbeiten in normalharten Werkstoffen sowie NE-Metallen.

Twist drill made in a metal forging process, thereby increasing of elasticity and breakage resistance. Suitable for robust drilling work in normal materials and non-ferrous metals.

Ø d1 mm	L 1 mm	L 2 mm	Ø d2 mm	L 3 mm		Artikel-Nr. Part-No.		Artikel-Nr. Part-No.
10,5	133	87	10	30	5	1109 01 01050	1	1109 07 01050
11,0	142	94	10	30	5	1109 01 01100	1	1109 07 01100
11,5	142	94	10	30	5	1109 01 01150	1	1109 07 01150
12,0	151	101	10	30	5	1109 01 01200	1	1109 07 01200
12,5	151	101	10	30	5	1109 01 01250	1	1109 07 01250
13,0	151	101	10	30	5	1109 01 01300	1	1109 07 01300
13,5	160	108	10	30	5	1109 01 01350	1	1109 07 01350
14,0	160	108	10	30	5	1109 01 01400	1	1109 07 01400
14,5	169	114	10	30	5	1109 01 01450	1	1109 07 01450
15,0	169	114	10	30	5	1109 01 01500	1	1109 07 01500
15,5	178	120	10	30	5	1109 01 01550	1	1109 07 01550
16,0	178	120	10	30	5	1109 01 01600	1	1109 07 01600
16,5	184	125	13	35	1	1109 01 01650	1	1109 07 01650
17,0	184	125	13	35	1	1109 01 01700	1	1109 07 01700
17,5	191	130	13	35	1	1109 01 01750	1	1109 07 01750
18,0	191	130	13	35	1	1109 01 01800	1	1109 07 01800
18,5	198	135	13	35	1	1109 01 01850	1	1109 07 01850
19,0	198	135	13	35	1	1109 01 01900	1	1109 07 01900
19,5	205	140	13	35	1	1109 01 01950	1	1109 07 01950
20,0	205	140	13	35	1	1109 01 02000	1	1109 07 02000

SPIRALBOHRER
TWIST DRILLS

Spiralbohrer DIN 338 HSS-G geschliffen, Kreuzanschliff
Twist drills DIN 338 HSS-G fully ground, split point

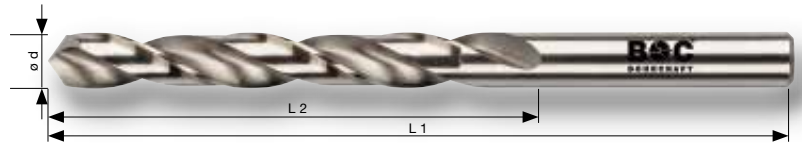

Code 1120



Code	P			M	K	N			S
	1.1 - 2.1	3.1 - 4.1	5.1	1.1 - 4.1	1.1 - 4.2	1.1 - 1.6	2.1 - 2.6	4.2	1.1 - 2.6
1120	☉				☉	☉	☉	☉	

Spiralbohrer für normalharte Werkstoffe wie allgemeine Bau-
stähle, NE-Metalle und Gusseisen.

Twist drill for materials with normal tensile strength, e.g. in
general structural steels, non ferrous materials and cast iron.

Ø d1 mm	L 1 mm	L 2 mm		Artikel-Nr. Part-No.		Artikel-Nr. Part-No.
0,50	22	6	10	1120 01 00050	-	-
0,60	24	7	10	1120 01 00060	-	-
0,70	28	9	10	1120 01 00070	-	-
0,80	30	10	10	1120 01 00080	-	-
0,90	32	11	10	1120 01 00090	-	-
1,00	34	12	10	1120 01 00100	3	1120 07 30100
1,10	36	14	10	1120 01 00110	-	-
1,20	38	16	10	1120 01 00120	-	-
1,25	38	16	10	1120 01 00125	-	-
1,30	38	16	10	1120 01 00130	-	-
1,40	40	18	10	1120 01 00140	-	-
1,50	40	18	10	1120 01 00150	3	1120 07 30150
1,60	43	20	10	1120 01 00160	-	-
1,70	43	20	10	1120 01 00170	-	-
1,75	46	23	10	1120 01 00175	-	-
1,80	46	23	10	1120 01 00180	-	-
1,90	46	23	10	1120 01 00190	-	-
2,00	49	24	10	1120 01 00200	3	1120 07 30200
2,10	49	24	10	1120 01 00210	-	-
2,20	53	27	10	1120 01 00220	-	-
2,25	53	27	10	1120 01 00225	-	-
2,30	53	27	10	1120 01 00230	-	-
2,40	57	30	10	1120 01 00240	-	-
2,50	57	30	10	1120 01 00250	3	1120 07 30250
2,60	57	30	10	1120 01 00260	-	-
2,70	61	33	10	1120 01 00270	-	-
2,75	61	33	10	1120 01 00275	-	-
2,80	61	33	10	1120 01 00280	-	-
2,90	61	33	10	1120 01 00290	-	-
3,00	61	33	10	1120 01 00300	3	1120 07 30300
3,10	65	36	10	1120 01 00310	3	1120 07 30310
3,20	65	36	10	1120 01 00320	3	1120 07 30320
3,25	65	36	10	1120 01 00325	-	-
3,30	65	36	10	1120 01 00330	3	1120 07 30330
3,40	70	39	10	1120 01 00340	-	-
3,50	70	39	10	1120 01 00350	2	1120 07 20350
3,60	70	39	10	1120 01 00360	-	-
3,70	70	39	10	1120 01 00370	-	-
3,75	70	39	10	1120 01 00375	-	-
3,80	75	43	10	1120 01 00380	-	-
3,90	75	43	10	1120 01 00390	-	-
4,00	75	43	10	1120 01 00400	2	1120 07 20400
4,10	75	43	10	1120 01 00410	2	1120 07 20410
4,20	75	43	10	1120 01 00420	2	1120 07 20420
4,25	75	43	10	1120 01 00425	-	-
4,30	80	47	10	1120 01 00430	-	-
4,40	80	47	10	1120 01 00440	-	-
4,50	80	47	10	1120 01 00450	2	1120 07 20450
4,60	80	47	10	1120 01 00460	-	-
4,70	80	47	10	1120 01 00470	-	-
4,75	80	47	10	1120 01 00475	-	-
4,80	86	52	10	1120 01 00480	2	1120 07 20480
4,90	86	52	10	1120 01 00490	-	-
5,00	86	52	10	1120 01 00500	2	1120 07 20500



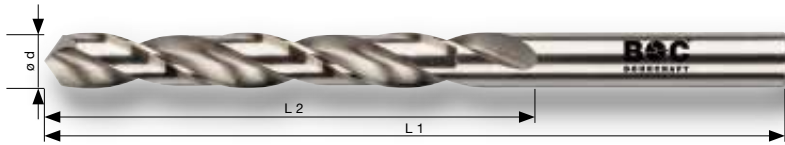

SPIRALBOHRER
TWIST DRILLS

Spiralbohrer DIN 338 HSS-G geschliffen, Kreuzanschliff
Twist drills DIN 338 HSS-G fully ground, split point



Code 1120

Ø d1 mm	L 1 mm	L 2 mm		Artikel-Nr. Part-No.		Artikel-Nr. Part-No.
5,10	86	52	10	1120 01 00510	1	1120 07 00510
5,20	86	52	10	1120 01 00520	-	-
5,25	86	52	10	1120 01 00525	-	-
5,30	86	52	10	1120 01 00530	-	-
5,40	93	57	10	1120 01 00540	-	-
5,50	93	57	10	1120 01 00550	1	1120 07 00550
5,60	93	57	10	1120 01 00560	-	-
5,70	93	57	10	1120 01 00570	-	-
5,75	93	57	10	1120 01 00575	-	-
5,80	93	57	10	1120 01 00580	-	-
5,90	93	57	10	1120 01 00590	-	-
6,00	93	57	10	1120 01 00600	1	1120 07 00600
6,10	101	63	10	1120 01 00610	-	-
6,20	101	63	10	1120 01 00620	-	-
6,25	101	63	10	1120 01 00625	-	-
6,30	101	63	10	1120 01 00630	-	-
6,40	101	63	10	1120 01 00640	-	-
6,50	101	63	10	1120 01 00650	1	1120 07 00650
6,60	101	63	10	1120 01 00660	-	-
6,70	101	63	10	1120 01 00670	-	-
6,75	109	69	10	1120 01 00675	-	-
6,80	109	69	10	1120 01 00680	1	1120 07 00680
6,90	109	69	10	1120 01 00690	-	-
7,00	109	69	10	1120 01 00700	1	1120 07 00700
7,10	109	69	10	1120 01 00710	-	-
7,20	109	69	10	1120 01 00720	-	-
7,25	109	69	10	1120 01 00725	-	-
7,30	109	69	10	1120 01 00730	-	-
7,40	109	69	10	1120 01 00740	-	-
7,50	109	69	10	1120 01 00750	1	1120 07 00750
7,60	117	75	10	1120 01 00760	-	-
7,70	117	75	10	1120 01 00770	-	-
7,75	117	75	10	1120 01 00775	-	-
7,80	117	75	10	1120 01 00780	-	-
7,90	117	75	10	1120 01 00790	-	-
8,00	117	75	10	1120 01 00800	1	1120 07 00800
8,10	117	75	10	1120 01 00810	-	-
8,20	117	75	10	1120 01 00820	-	-
8,25	117	75	10	1120 01 00825	-	-
8,30	117	75	10	1120 01 00830	-	-
8,40	117	75	10	1120 01 00840	-	-
8,50	117	75	10	1120 01 00850	1	1120 07 00850
8,60	125	81	10	1120 01 00860	-	-
8,70	125	81	10	1120 01 00870	-	-
8,75	125	81	10	1120 01 00875	-	-
8,80	125	81	10	1120 01 00880	-	-
8,90	125	81	10	1120 01 00890	-	-
9,00	125	81	10	1120 01 00900	1	1120 07 00900
9,10	125	81	10	1120 01 00910	-	-
9,20	125	81	10	1120 01 00920	-	-
9,25	125	81	10	1120 01 00925	-	-
9,30	125	81	10	1120 01 00930	-	-
9,40	125	81	10	1120 01 00940	-	-
9,50	125	81	10	1120 01 00950	1	1120 07 00950
9,60	133	87	10	1120 01 00960	-	-
9,70	133	87	10	1120 01 00970	-	-
9,75	133	87	10	1120 01 00975	-	-
9,80	133	87	10	1120 01 00980	-	-
9,90	133	87	10	1120 01 00990	-	-
10,00	133	87	10	1120 01 01000	1	1120 07 01000
10,10	133	87	5	1120 01 01010	-	-
10,20	133	87	5	1120 01 01020	1	1120 07 01020
10,25	133	87	5	1120 01 01025	-	-
10,30	133	87	5	1120 01 01030	-	-
10,40	133	87	5	1120 01 01040	-	-
10,50	133	87	5	1120 01 01050	1	1120 07 01050



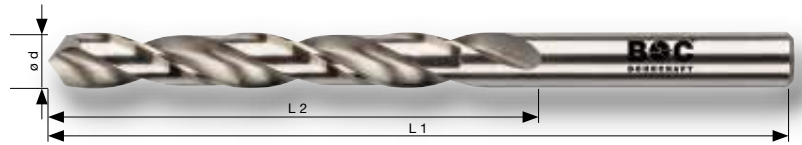

**SPIRALBOHRER
TWIST DRILLS**

Spiralbohrer DIN 338 HSS-G geschliffen, Kreuzanschliff
Twist drills DIN 338 HSS-G fully ground, split point



Code 1120

Ø d1 mm	L 1 mm	L 2 mm		Artikel-Nr. Part-No.		Artikel-Nr. Part-No.
10,60	142	94	5	1120 01 01060	-	-
10,70	142	94	5	1120 01 01070	-	-
10,75	142	94	5	1120 01 01075	-	-
10,80	142	94	5	1120 01 01080	-	-
10,90	142	94	5	1120 01 01090	-	-
11,00	142	94	5	1120 01 01100	1	1120 07 01100
11,10	142	94	5	1120 01 01110	-	-
11,20	142	94	5	1120 01 01120	-	-
11,25	142	94	5	1120 01 01125	-	-
11,30	142	94	5	1120 01 01130	-	-
11,50	142	94	5	1120 01 01150	1	1120 07 01150
11,75	142	94	5	1120 01 01175	-	-
11,80	142	94	5	1120 01 01180	-	-
11,90	142	94	5	1120 01 01190	-	-
12,00	151	101	5	1120 01 01200	1	1120 07 01200
12,20	151	101	5	1120 01 01220	-	-
12,25	151	101	5	1120 01 01225	-	-
12,50	151	101	5	1120 01 01250	1	1120 07 01250
12,70	151	101	5	1120 01 01270	-	-
12,75	151	101	5	1120 01 01275	-	-
12,80	151	101	5	1120 01 01280	-	-
13,00	151	101	5	1120 01 01300	1	1120 07 01300
13,50	160	108	5	1120 01 01350	-	-
14,00	160	108	5	1120 01 01400	-	-
14,50	169	114	5	1120 01 01450	-	-
15,00	169	114	5	1120 01 01500	-	-
15,50	178	120	5	1120 01 01550	-	-
16,00	178	120	5	1120 01 01600	-	-

BC ABS-Boxen / BC ABS-Boxes

Bezeichnung Description	Teile Pieces	Inhalt Content	Artikel-Nr. Part-No.
KG 10	19	Ø 1,0 – 10,0 mm x 0,5 mm	1120 13 30019
KG 13	25	Ø 1,0 – 13,0 mm x 0,5 mm	1120 13 30025
KG 24	24	Ø 1,0 – 10,5 mm x 0,5 mm + Ø 3,3 / 4,2 / 6,8 / 10,2 mm	1120 13 30024
KG 591	51	Ø 1,0 – 6,0 mm x 0,1 mm	1120 13 30050
KG 601	41	Ø 6,0 – 10,0 mm x 0,1 mm	1120 13 30041
KG 170	170	Ø 1,0 – 10,0 mm x 0,5 mm Ø 1,0 – 8,0 mm = 10 St. / pcs. Ø 8,5 – 10,0 mm = 5 St. / pcs.	1120 13 30170



BC Grip-Box / BC Grip-Box

Bezeichnung Description	Teile Pieces	Inhalt Content	Artikel-Nr. Part-No.
VG 10	19	Ø 1,0 – 10,0 mm x 0,5 mm	1120 14 10119



Kunststoff-Kassette / Plastic-Box

Bezeichnung Description	Teile Pieces	Inhalt Content	Display 	Artikel-Nr. Part-No.
PG 6	6	Ø 2 · 3 · 4 · 5 · 6 · 8 mm	18	1120 14 30006



Spiralbohrer DIN 338 HSS-G geschliffen, Kreuzanschliff
 Twist drills DIN 338 HSS-G fully ground, split point



Code 1120

BC Industrie-Kassetten / BC Metal-Boxes

Bezeichnung Description	Teile Pieces	Inhalt Content	Artikel-Nr. Part-No.
MG 10	19	Ø 1,0 – 10,0 mm x 0,5 mm	1120 13 10019
MG 13	25	Ø 1,0 – 13,0 mm x 0,5 mm	1120 13 10025
MG 24	24	Ø 1,0 – 10,5 mm x 0,5 mm + Ø 3,3 / 4,2 / 6,8 / 10,2 mm	1120 14 10024
MG 591	50	Ø 1,0 – 5,9 mm x 0,1 mm	1120 14 10050
MG 601	41	Ø 6,0 – 10,0 mm x 0,1 mm	1120 14 10041
MG 210	81	Ø 2,0 – 10,0 mm x 0,1 mm	1120 14 20081
MG 130	130	Ø 1,0 – 6,0 mm x 0,5 mm + Ø 3,3 / 4,2 mm Ø 1,0 – 6,0 mm = 10 St. / pcs.	1120 13 10130
MG 170	170	Ø 1,0 – 10,0 mm x 0,5 mm Ø 1,0 – 8,0 mm = 10 St. / pcs. Ø 8,5 – 10,0 mm = 5 St. / pcs.	1120 14 10170
MG 220	220	Ø 1,0 – 13,0 mm x 0,5 mm + 3,3 / 4,2 mm Ø 1,0 – 8,0 mm = 10 St. / pcs. Ø 8,5 – 13,0 mm = 5 St. / pcs.	1120 14 20220



MG 10



MG 591



MG 210



MG 170

Spiralbohrer DIN 338 HSS-G, mit reduziertem Schaft, Kreuzanschliff
Twist drills DIN 338 HSS-G, reduced shank, split point

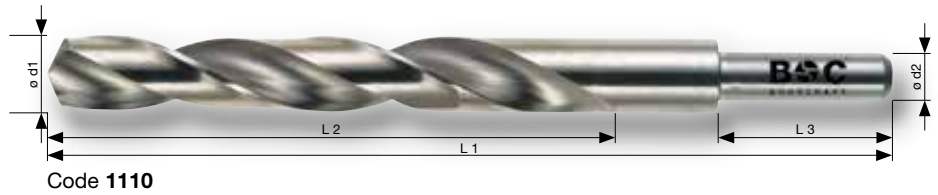

Code	P			M	K	N			S
	1.1 - 2.1	3.1 - 4.1	5.1	1.1 - 4.1	1.1 - 4.2	1.1 - 1.6	2.1 - 2.6	4.2	1.1 - 2.6
1110	☞				☞	☞	☞	☞	☞

Spiralbohrer für normalharte Werkstoffe wie allgemeine Bau-
stähle, NE-Metalle und Gusseisen.

Twist drill for materials with normal tensile strength, e.g. in
general structural steels, non ferrous materials and cast iron.

Ø d1 mm	L1 mm	L2 mm	Ø d2 mm	L3 mm		Artikel-Nr. Part-No.		Artikel-Nr. Part-No.
10,5	133	87	10	30	5	1110 01 01050	1	1110 07 01050
11,0	142	94	10	30	5	1110 01 01100	1	1110 07 01100
11,5	142	94	10	30	5	1110 01 01150	1	1110 07 01150
12,0	151	101	10	30	5	1110 01 01200	1	1110 07 01200
12,5	151	101	10	30	5	1110 01 01250	1	1110 07 01250
13,0	151	101	10	30	5	1110 01 01300	1	1110 07 01300
13,5	160	108	10	30	5	1110 01 01350	1	1110 07 01350
14,0	160	108	10	30	5	1110 01 01400	1	1110 07 01400
14,5	169	114	10	30	5	1110 01 01450	1	1110 07 01450
15,0	169	114	10	30	5	1110 01 01500	1	1110 07 01500
15,5	178	120	10	30	5	1110 01 01550	1	1110 07 01550
16,0	178	120	10	30	5	1110 01 01600	1	1110 07 01600
16,5	184	125	13	35	1	1110 01 01650	1	1110 07 01650
17,0	184	125	13	35	1	1110 01 01700	1	1110 07 01700
17,5	191	130	13	35	1	1110 01 01750	1	1110 07 01750
18,0	191	130	13	35	1	1110 01 01800	1	1110 07 01800
18,5	198	135	13	35	1	1110 01 01850	1	1110 07 01850
19,0	198	135	13	35	1	1110 01 01900	1	1110 07 01900
19,5	205	140	13	35	1	1110 01 01950	1	1110 07 01950
20,0	205	140	13	35	1	1110 01 02000	1	1110 07 02000
20,5	212	145	13	40	1	1110 01 02050	-	-
21,0	212	145	13	40	1	1110 01 02100	-	-
21,5	219	150	13	40	1	1110 01 02150	-	-
22,0	219	150	13	40	1	1110 01 02200	-	-
22,5	226	155	13	40	1	1110 01 02250	-	-
23,0	226	155	13	40	1	1110 01 02300	-	-
23,5	233	155	13	40	1	1110 01 02350	-	-
24,0	233	160	13	40	1	1110 01 02400	-	-
24,5	233	160	13	40	1	1110 01 02450	-	-
25,0	233	160	13	40	1	1110 01 02500	-	-



SPIRALBOHRER
TWIST DRILLS

Spiralbohrer DIN 338 HSS-TiN titannitriert, Kreuzanschliff

Twist drills DIN 338 HSS-TiN titanium coated, split point

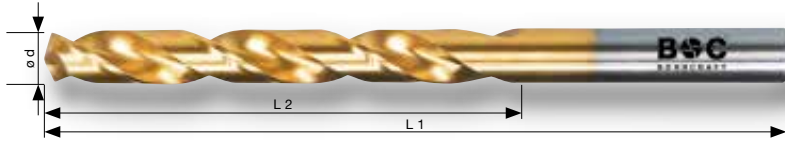

Code 1130



Code	P			M	K	N			S
	1.1 - 2.1	3.1 - 4.1	5.1	1.1 - 4.1	1.1 - 4.2	1.1 - 1.6	2.1 - 2.6	4.2	1.1 - 2.6
1130									

Spiralbohrer für normalharte Werkstoffe wie allgemeine Bau-
stähle, NE-Metalle und Gusseisen.

Twist drill for materials with normal tensile strength, e.g. in
general structural steels, non ferrous materials and cast iron.

Ø d mm	L 1 mm	L 2 mm		Artikel-Nr. Part-No.		Artikel-Nr. Part-No.
1,0	34	12	10	1130 01 30100	1	1130 07 00100
1,5	40	18	10	1130 01 30150	1	1130 07 00150
2,0	49	24	10	1130 01 30200	1	1130 07 00200
2,5	57	30	10	1130 01 30250	1	1130 07 00250
3,0	61	33	10	1130 01 30300	1	1130 07 00300
3,2	65	36	10	1130 01 30320	1	1130 07 00320
3,3	65	36	10	1130 01 30330	1	1130 07 00330
3,5	70	39	10	1130 01 20350	1	1130 07 00350
4,0	75	43	10	1130 01 20400	1	1130 07 00400
4,1	75	43	10	1130 01 20410	1	1130 07 00410
4,2	75	43	10	1130 01 20420	1	1130 07 00420
4,5	80	47	10	1130 01 20450	1	1130 07 00450
4,8	86	52	10	1130 01 20480	1	1130 07 00480
5,0	86	52	10	1130 01 20500	1	1130 07 00500
5,2	86	52	10	1130 01 00520	1	1130 07 00520
5,5	93	57	10	1130 01 00550	1	1130 07 00550
6,0	93	57	10	1130 01 00600	1	1130 07 00600
6,5	101	63	10	1130 01 00650	1	1130 07 00650
6,8	109	69	10	1130 01 00680	1	1130 07 00680
7,0	109	69	10	1130 01 00700	1	1130 07 00700
7,5	109	69	10	1130 01 00750	1	1130 07 00750
8,0	117	75	10	1130 01 00800	1	1130 07 00800
8,5	117	75	10	1130 01 00850	1	1130 07 00850
9,0	125	81	10	1130 01 00900	1	1130 07 00900
9,5	125	81	10	1130 01 00950	1	1130 07 00950
10,0	133	87	10	1130 01 01000	1	1130 07 01000
10,2	133	87	5	1130 01 01020	-	-
10,5	133	87	5	1130 01 01050	1	1130 07 01050
11,0	142	94	5	1130 01 01100	1	1130 07 01100
11,5	142	94	5	1130 01 01150	1	1130 07 01150
12,0	151	101	5	1130 01 01200	1	1130 07 01200
12,5	151	101	5	1130 01 01250	1	1130 07 01250
13,0	151	101	5	1130 01 01300	1	1130 07 01300

BC ABS-Boxen / BC ABS-Boxes

Bezeichnung Description	Teile Pieces	Inhalt Content	Artikel-Nr. Part-No.
KT 10	19	Ø 1,0 – 10,0 mm x 0,5 mm	1130 13 30019
KT 13	25	Ø 1,0 – 13,0 mm x 0,5 mm	1130 13 30025



BC Industrie-Kassetten / BC Metal-Boxes

Bezeichnung Description	Teile Pieces	Inhalt Content	Artikel-Nr. Part-No.
MT 10	19	Ø 1,0 – 10,0 mm x 0,5 mm	1130 13 10019
MT 13	25	Ø 1,0 – 13,0 mm x 0,5 mm	1130 13 10025
MT 130	130	Ø 1,0 – 6,0 mm x 0,5 mm + 3,3 / 4,2 mm Ø 1,0 – 6,0 mm = 10 St. / pcs.	1130 13 10130
MT 170	170	Ø 1,0 – 10,0 mm x 0,5 mm Ø 1,0 – 8,0 mm = 10 St. / pcs. Ø 8,5 – 10,0 mm = 5 St. / pcs.	1130 14 10170



SPIRALBOHRER
TWIST DRILLS

Spiralbohrer DIN 338 HSS-G Typ N geschliffen, Kreuzanschliiff

Twist drills DIN 338 HSS-G type N fully ground, split point



Code 1121



Code 1119 Dampfangelassen / Black oxide finish

Ø d mm	L 1 mm	L 2 mm		OX	
				Artikel-Nr. Part-No.	Artikel-Nr. Part-No.
9,50	125	81	10	1121 01 00950	1119 01 00950
9,60	133	87	10	1121 01 00960	1119 01 00960
9,70	133	87	10	1121 01 00970	1119 01 00970
9,75	133	87	10	-	1119 01 00975
9,80	133	87	10	1121 01 00980	1119 01 00980
9,90	133	87	10	1121 01 00990	1119 01 00990
10,00	133	87	10	1121 01 01000	1119 01 01000
10,10	133	87	5	-	1119 01 01010
10,20	133	87	5	1121 01 01020	1119 01 01020
10,25	133	87	5	-	1119 01 01025
10,30	133	87	5	1121 01 01030	-
10,40	133	87	5	1121 01 01040	-
10,50	133	87	5	1121 01 01050	1119 01 01050
10,75	142	94	5	-	1119 01 01075
11,00	142	94	5	1121 01 01100	1119 01 01100
11,25	142	94	5	-	1119 01 01125
11,50	142	94	5	1121 01 01150	1119 01 01150
11,75	142	94	5	-	1119 01 01175
12,00	151	101	5	1121 01 01200	1119 01 01200

Ø d mm	L 1 mm	L 2 mm		OX	
				Artikel-Nr. Part-No.	Artikel-Nr. Part-No.
12,25	151	101	5	-	1119 01 01225
12,30	151	101	5	1121 01 01230	-
12,40	151	101	5	1121 01 01240	-
12,50	151	101	5	1121 01 01250	1119 01 01250
12,75	151	101	5	-	1119 01 01275
13,00	151	101	5	1121 01 01300	1119 01 01300
13,25	160	108	5	-	1119 01 01325
13,50	160	108	5	1121 01 01350	1119 01 01350
13,75	160	108	5	-	1119 01 01375
14,00	160	108	5	1121 01 01400	1119 01 01400
14,25	169	114	5	-	1119 01 01425
14,50	169	114	5	1121 01 01450	1119 01 01450
14,75	169	114	5	-	1119 01 01475
15,00	169	114	5	1121 01 01500	1119 01 01500
15,25	178	120	5	-	1119 01 01525
15,50	178	120	5	1121 01 01550	1119 01 01550
15,75	178	120	5	-	1119 01 01575
16,00	178	120	5	1121 01 01600	1119 01 01600

BC ABS-Boxen / BC ABS-Boxes

Bezeichnung Description	Teile Pieces	Inhalt Content	Artikel-Nr. Part-No.
KG 10 OX	19	Ø 1,0 – 10,0 mm x 0,5 mm	1119 13 30019
KG 13 OX	25	Ø 1,0 – 13,0 mm x 0,5 mm	1119 13 30025
KG 10 PB	19	Ø 1,0 – 10,0 mm x 0,5 mm	1121 13 30019
KG 13 PB	25	Ø 1,0 – 13,0 mm x 0,5 mm	1121 13 30025

BC Industrie-Kassetten / BC Metal-Boxes

Bezeichnung Description	Teile Pieces	Inhalt Content	Artikel-Nr. Part-No.
MG 10 PB	19	Ø 1,0 – 10,0 mm x 0,5 mm	1121 13 10019
MG 13 PB	25	Ø 1,0 – 13,0 mm x 0,5 mm	1121 13 10025
MG 170 PB	170	Ø 1,0 – 10,0 mm x 0,5 mm Ø 1,0 – 8,0 mm = 10 St. / pcs. Ø 8,5 – 10,0 mm = 5 St. / pcs.	1121 13 10170



KG 10 OX



KG 10 PB



MG 10 PB



MG 170 PB

Spiralbohrer DIN 338 HSS-G Typ N **geschliffen**, reduz. Schaft, Kreuzanschliff
Twist drills DIN 338 HSS-G type N **fully ground**, reduced shank, split point

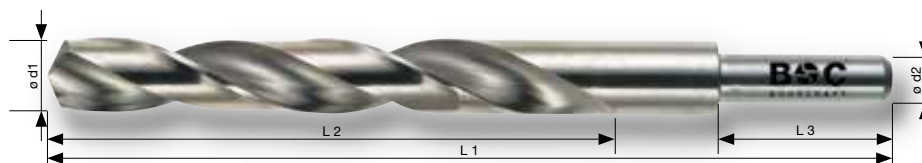

Code 1121-red.



Code	P			M	K	N		S
	1.1 - 2.1	3.1 - 4.1	5.1	1.1 - 4.1	1.1 - 4.2	1.1 - 1.6	2.1 - 2.6	4.2
1121	☉	☉			☉	☉	☉	☉

Spiralbohrer für normalharte Werkstoffe wie allgemeine Bau-
stähle, NE-Metalle und Gusseisen.

Twist drill for materials with normal tensile strength, e.g. in
general structural steels, non ferrous materials and cast iron.

Ø d1 mm	L 1 mm	L 2 mm	Ø d2 mm	L 3 mm		Artikel-Nr. Part-No.
13,50	160	108	13	30	1	1121 01 11350
14,00	160	108	13	30	1	1121 01 11400
14,30	169	114	13	30	1	1121 01 11430
14,40	169	114	13	30	1	1121 01 11440
14,50	169	114	13	30	1	1121 01 11450
15,00	169	114	13	30	1	1121 01 11500
15,50	178	120	13	30	1	1121 01 11550
16,00	178	120	13	30	1	1121 01 11600
16,40	184	125	13	35	1	1121 01 11640
16,50	184	125	13	35	1	1121 01 11650
17,00	184	125	13	35	1	1121 01 11700
17,50	191	130	13	35	1	1121 01 11750
18,00	191	130	13	35	1	1121 01 11800
18,50	198	135	13	35	1	1121 01 11850
18,60	198	135	13	35	1	1121 01 11860
19,00	198	135	13	35	1	1121 01 11900
19,50	205	140	13	35	1	1121 01 11950
20,00	205	140	13	35	1	1121 01 12000
20,50	225	145	13	40	1	1121 01 12050
20,60	225	145	13	40	1	1121 01 12060
21,00	225	145	13	40	1	1121 01 12100
21,50	230	150	13	40	1	1121 01 12150
22,00	230	150	13	40	1	1121 01 12200
22,50	230	155	13	40	1	1121 01 12250
22,60	230	155	13	40	1	1121 01 12260
23,00	230	155	13	40	1	1121 01 12300
23,50	230	155	13	40	1	1121 01 12350
24,00	250	160	13	40	1	1121 01 12400
24,50	250	160	13	40	1	1121 01 12450
24,75	250	160	13	40	1	1121 01 12475
25,00	250	160	13	40	1	1121 01 12500



SPIRALBOHRER
TWIST DRILLS

Spiralbohrer DIN 338 HSS-G Typ N geschliffen, Kreuzanschliff
Twist drills DIN 338 HSS-G type N fully ground, split point

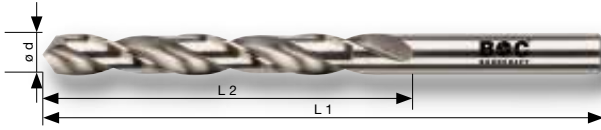

Code 1122



Code 1123 TiN

Ø d mm	L 1 mm	L 2 mm		TiN	
				Artikel-Nr. Part-No.	Artikel-Nr. Part-No.
10,90	142	94	5	1122 03 01090	1123 03 01090
11,00	142	94	5	1122 03 01100	1123 03 01100
11,10	142	94	5	1122 03 01110	1123 03 01110
11,20	142	94	5	1122 03 01120	1123 03 01120
11,30	142	94	5	1122 03 01130	1123 03 01130
11,40	142	94	5	1122 03 01140	1123 03 01140
11,50	142	94	5	1122 03 01150	1123 03 01150
11,60	151	101	5	1122 03 01160	1123 03 01160
11,70	151	101	5	1122 03 01170	1123 03 01170
11,80	151	101	5	1122 03 01180	1123 03 01180
11,90	151	101	5	1122 03 01190	1123 03 01190
12,00	151	101	5	1122 03 01200	1123 03 01200
12,10	151	101	5	1122 03 01210	1123 03 01210
12,20	151	101	5	1122 03 01220	1123 03 01220

Ø d mm	L 1 mm	L 2 mm		TiN	
				Artikel-Nr. Part-No.	Artikel-Nr. Part-No.
12,30	151	101	5	1122 03 01230	1123 03 01230
12,40	151	101	5	1122 03 01240	1123 03 01240
12,50	151	101	5	1122 03 01250	1123 03 01250
12,60	151	101	5	1122 03 01260	1123 03 01260
12,70	151	101	5	1122 03 01270	1123 03 01270
12,80	151	101	5	1122 03 01280	1123 03 01280
12,90	151	101	5	1122 03 01290	1123 03 01290
13,00	151	101	5	1122 03 01300	1123 03 01300
13,50	160	108	1	1122 03 01350	-
14,00	160	108	1	1122 03 01400	-
14,50	169	114	1	1122 03 01450	-
15,00	169	114	1	1122 03 01500	-
15,50	178	120	1	1122 03 01550	-
16,00	178	120	1	1122 03 01600	-

BC ABS-Boxen / BC ABS-Boxes

Bezeichnung Description	Teile Pieces	Inhalt Content	Artikel-Nr. Part-No.
KG 10 P-Plus	19	Ø 1,0 – 10,0 mm x 0,5 mm	1122 14 30019
KG 13 P-Plus	25	Ø 1,0 – 13,0 mm x 0,5 mm	1122 14 30025
KG 591 P-Plus	51	Ø 1,0 – 6,0 mm x 0,1 mm	1122 14 30050
KG 601 P-Plus	41	Ø 6,0 – 10,0 mm x 0,1 mm	1122 14 30041

BC Profi-Plus Industrie-Kassetten / BC Profi-Plus Metal-Boxes

Bezeichnung Description	Teile Pieces	Inhalt Content	Artikel-Nr. Part-No.
MG 10 P-Plus	19	Ø 1,0 – 10,0 mm x 0,5 mm	1122 14 10019
MG 13 P-Plus	25	Ø 1,0 – 13,0 mm x 0,5 mm	1122 14 10025
MG 70 P-Plus	70	Ø 1,0 – 5,0 mm x 0,5 mm = 5 St. / pcs. Ø 5,5 – 7,5 mm x 0,5 mm = 3 St. / pcs. Ø 8,0 – 10,0 mm x 0,5 mm = 2 St. / pcs.	1122 14 10070



KG 10 P-PLUS



MG 10 P-PLUS



MG 170 P-PLUS

SPIRALBOHRER
TWIST DRILLS

Spiralbohrer DIN 338 HSS-G, mit reduziertem Schaft, Kreuzanschliiff Twist drills DIN 338 HSS-G, reduced shank, split point

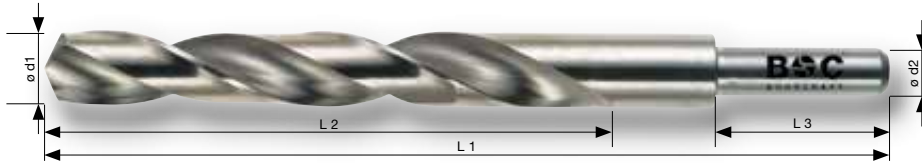

Code 1122-red.



Code	P			M	K	N		S
	1.1 - 2.1	3.1 - 4.1	5.1	1.1 - 4.1	1.1 - 4.2	1.1 - 1.6	2.1 - 2.6	4.2
1122	⊗	⊗			⊗	⊗	⊗	⊗

Premium Spiralbohrer für normalharte Werkstoffe wie allgemeine Baustähle, NE-Metalle und Gusseisen.

Premium twist drill for materials with normal tensile strength, e.g. in general structural steels, non ferrous materials and cast iron.

Ø d1 mm	L 1 mm	L 2 mm	Ø d2 mm	L 3 mm		Artikel-Nr. Part-No.
10,5	133	87	10	30	1	1122 03 11050
11,0	142	94	10	30	1	1122 03 11100
11,5	142	94	10	30	1	1122 03 11150
12,0	151	101	10	30	1	1122 03 11200
12,5	151	101	10	30	1	1122 03 11250
13,0	151	101	10	30	1	1122 03 11300
13,5	160	108	10	30	1	1122 03 11350
14,0	160	108	10	30	1	1122 03 11400
14,5	169	114	10	30	1	1122 03 11450
15,0	169	114	10	30	1	1122 03 11500
15,5	178	120	10	30	1	1122 03 11550
16,0	178	120	10	30	1	1122 03 11600
17,0	184	125	13	35	1	1122 03 11700
18,0	191	130	13	35	1	1122 03 11800
19,0	198	135	13	35	1	1122 03 11900
20,0	205	140	13	35	1	1122 03 12000

SPIRALBOHRER
TWIST DRILLS

Spiralbohrer TiN-Point DIN 338 HSS-G titannitriert Typ N-TP, Kreuzanschliff
Twist drills TiN-point DIN 338 HSS-G titanium coated type N-TP, split point

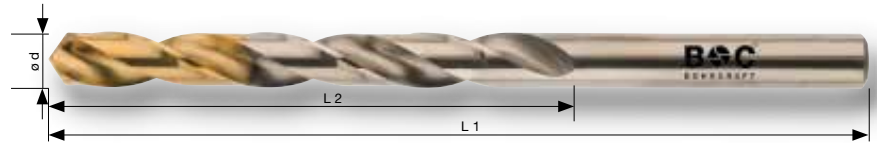

Code 1124

DIN 338 HSS G Typ N-TP 118° SPLIT POINT 5xD TiN

Code	P			M	K	N		S
	1.1 - 2.1	3.1 - 4.1	5.1	1.1 - 4.1	1.1 - 4.2	1.1 - 1.6	2.1 - 2.6	4.2
1124	☉	☉			☉		☉	☉

Premium Spiralbohrer für normalharte Werkstoffe wie allgemeine Baustähle, NE-Metalle und Gusseisen.

Premium twist drill for materials with normal tensile strength, e.g. in general structural steels, non ferrous materials and cast iron.

TiN-Beschichtung im Arbeitsbereich für höhere Standzeit!

TiN-coating on working part for longer tool life!

Ø d mm	L 1 mm	L 2 mm	☉	Artikel-Nr. Part-No.
1,0	34	12	10	1124 03 00100
1,5	40	18	10	1124 03 00150
1,6	43	20	10	1124 03 00160
1,7	43	20	10	1124 03 00170
1,8	46	23	10	1124 03 00180
1,9	46	23	10	1124 03 00190
2,0	49	24	10	1124 03 00200
2,1	49	24	10	1124 03 00210
2,2	53	27	10	1124 03 00220
2,3	53	27	10	1124 03 00230
2,4	57	30	10	1124 03 00240
2,5	57	30	10	1124 03 00250
2,6	57	30	10	1124 03 00260
2,7	61	33	10	1124 03 00270
2,8	61	33	10	1124 03 00280
2,9	61	33	10	1124 03 00290
3,0	61	33	10	1124 03 00300
3,1	65	36	10	1124 03 00310
3,2	65	36	10	1124 03 00320
3,3	65	36	10	1124 03 00330
3,4	70	39	10	1124 03 00340
3,5	70	39	10	1124 03 00350
3,6	70	39	10	1124 03 00360
3,7	70	39	10	1124 03 00370
3,8	70	43	10	1124 03 00380
3,9	75	43	10	1124 03 00390
4,0	75	43	10	1124 03 00400
4,1	75	43	10	1124 03 00410
4,2	75	43	10	1124 03 00420
4,3	80	47	10	1124 03 00430
4,4	80	47	10	1124 03 00440
4,5	80	47	10	1124 03 00450
4,6	80	47	10	1124 03 00460
4,7	80	47	10	1124 03 00470
4,8	86	52	10	1124 03 00480
4,9	86	52	10	1124 03 00490
5,0	86	52	10	1124 03 00500
5,1	86	52	10	1124 03 00510
5,2	86	52	10	1124 03 00520
5,3	86	52	10	1124 03 00530
5,4	93	57	10	1124 03 00540
5,5	93	57	10	1124 03 00550
5,6	93	57	10	1124 03 00560
5,7	93	57	10	1124 03 00570
5,8	93	57	10	1124 03 00580
5,9	93	57	10	1124 03 00590
6,0	93	57	10	1124 03 00600
6,1	101	63	10	1124 03 00610
6,2	101	63	10	1124 03 00620
6,3	101	63	10	1124 03 00630
6,4	101	63	10	1124 03 00640
6,5	101	63	10	1124 03 00650

Ø d mm	L 1 mm	L 2 mm	☉	Artikel-Nr. Part-No.
6,6	101	63	10	1124 03 00660
6,7	101	63	10	1124 03 00670
6,8	109	69	10	1124 03 00680
6,9	109	69	10	1124 03 00690
7,0	109	69	10	1124 03 00700
7,1	109	69	5	1124 03 00710
7,2	109	69	5	1124 03 00720
7,3	109	69	5	1124 03 00730
7,4	109	69	5	1124 03 00740
7,5	109	69	5	1124 03 00750
7,6	117	75	5	1124 03 00760
7,7	117	75	5	1124 03 00770
7,8	117	75	5	1124 03 00780
7,9	117	75	5	1124 03 00790
8,0	117	75	5	1124 03 00800
8,1	117	75	5	1124 03 00810
8,2	117	75	5	1124 03 00820
8,3	117	75	5	1124 03 00830
8,4	117	75	5	1124 03 00840
8,5	117	75	5	1124 03 00850
8,6	125	81	5	1124 03 00860
8,7	125	81	5	1124 03 00870
8,8	125	81	5	1124 03 00880
8,9	125	81	5	1124 03 00890
9,0	125	81	5	1124 03 00900
9,1	125	81	5	1124 03 00910
9,2	125	81	5	1124 03 00920
9,3	125	81	5	1124 03 00930
9,4	125	81	5	1124 03 00940
9,5	125	81	5	1124 03 00950
9,6	133	87	5	1124 03 00960
9,7	133	87	5	1124 03 00970
9,8	133	87	5	1124 03 00980
9,9	133	87	5	1124 03 00990
10,0	133	87	5	1124 03 01000
10,1	133	87	5	1124 03 01010
10,2	133	87	5	1124 03 01020
10,3	133	87	5	1124 03 01030
10,4	133	87	5	1124 03 01040
10,5	133	87	5	1124 03 01050
10,6	142	94	5	1124 03 01060
10,7	142	94	5	1124 03 01070
10,8	142	94	5	1124 03 01080
10,9	142	94	5	1124 03 01090
11,0	142	94	5	1124 03 01100
11,1	142	94	5	1124 03 01110
11,2	142	94	5	1124 03 01120
11,3	142	94	5	1124 03 01130
11,4	142	94	5	1124 03 01140
11,5	142	94	5	1124 03 01150
11,6	151	101	5	1124 03 01160
11,7	151	101	5	1124 03 01170



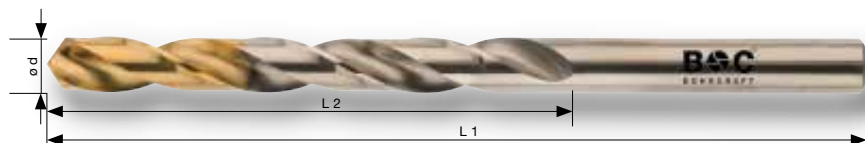

SPIRALBOHRER
TWIST DRILLS

Spiralbohrer TiN-Point DIN 338 HSS-G titannitriert Typ N-TP, Kreuzanschliff
Twist drills TiN-point DIN 338 HSS-G titanium coated Type N-TP, split point



Code 1124

Ø d mm	L 1 mm	L 2 mm		Artikel-Nr. Part-No.
11,8	151	101	5	1124 03 01180
11,9	151	101	5	1124 03 01190
12,0	151	101	5	1124 03 01200
12,1	151	101	5	1124 03 01210
12,2	151	101	5	1124 03 01220
12,3	151	101	5	1124 03 01230
12,4	151	101	5	1124 03 01240

Ø d mm	L 1 mm	L 2 mm		Artikel-Nr. Part-No.
12,5	151	101	5	1124 03 01250
12,6	151	101	5	1124 03 01260
12,7	151	101	5	1124 03 01270
12,8	151	101	5	1124 03 01280
12,9	151	101	5	1124 03 01290
13,0	151	101	5	1124 03 01300

BC Profi-Plus Industrie-Kassetten / BC Profi-Plus Metal-Boxes

Bezeichnung Description	Teile Pieces	Inhalt Content	Artikel-Nr. Part-No.
MG 10 TiN-Point	19	Ø 1,0 – 10,0 mm x 0,5 mm	1124 13 10019
MG 13 TiN-Point	25	Ø 1,0 – 13,0 mm x 0,5 mm	1124 13 10025



MG 10 TiN-Point



- TiN-Beschichtung im Arbeitsbereich
- Hohe Standzeit durch härtere Oberfläche im beschichteten Bereich
- TiN-coating on cutting part
- Long tool life due to hard surface on coated part



Spiralbohrer **LINKS** DIN 338 HSS-G Typ LN geschliffen, Kreuzanschliff
Twist drills **LEFT HAND** DIN 338 HSS-G type LN fully ground, split point



Code 1129



Code	P			M	K	N		S
	1.1 - 2.1	3.1 - 4.1	5.1	1.1 - 4.1	1.1 - 4.2	1.1 - 1.6	2.1 - 2.6	4.2
1129								

Linksschneidender Spiralbohrer für normalharte Werkstoffe wie allgemeine Baustähle, NE-Metalle und Gusseisen.

Left-hand cutting twist drill for materials with normal tensile strength, e.g. in general structural steels, non ferrous materials and cast iron.

Ø d mm	L 1 mm	L 2 mm		Artikel-Nr. Part-No.
1,0	34	12	10	1129 03 00100
1,5	40	18	10	1129 03 00150
2,0	49	24	10	1129 03 00200
2,4	57	30	10	1129 03 00240
2,5	57	30	10	1129 03 00250
2,6	57	30	10	1129 03 00260
3,0	61	33	10	1129 03 00300
3,2	65	36	10	1129 03 00320
3,3	65	36	10	1129 03 00330
3,4	70	39	10	1129 03 00340
3,5	70	39	10	1129 03 00350
4,0	75	43	10	1129 03 00400
4,2	75	43	10	1129 03 00420
4,5	80	47	10	1129 03 00450
4,8	86	52	10	1129 03 00480
5,0	86	52	10	1129 03 00500
5,2	86	52	10	1129 03 00520
5,5	93	57	10	1129 03 00550

Ø d mm	L 1 mm	L 2 mm		Artikel-Nr. Part-No.
6,0	93	57	10	1129 03 00600
6,5	101	63	10	1129 03 00650
6,8	109	69	10	1129 03 00680
6,9	109	69	10	1129 03 00690
7,0	109	69	10	1129 03 00700
7,5	109	69	5	1129 03 00750
8,0	117	75	5	1129 03 00800
8,5	117	75	5	1129 03 00850
9,0	125	81	5	1129 03 00900
9,5	125	81	5	1129 03 00950
10,0	133	87	5	1129 03 01000
10,2	133	87	5	1129 03 01020
10,5	133	87	5	1129 03 01050
11,0	142	94	5	1129 03 01100
11,5	142	94	5	1129 03 01150
12,0	151	101	5	1129 03 01200
12,5	151	101	5	1129 03 01250
13,0	151	101	5	1129 03 01300

BC Profi-Plus Industrie-Kassetten / BC Profi-Plus Metal-Boxes

Bezeichnung Description	Teile Pieces	Inhalt Content	Artikel-Nr. Part-No.
MG 10-LH	19	Ø 1,0 – 10,0 mm x 0,5 mm	1129 13 10019
MG 13-LH	25	Ø 1,0 – 13,0 mm x 0,5 mm	1129 13 10025

BC Multi-Pack / BC Multi-Pack

Bezeichnung Description	Teile Pieces	Inhalt Content	Artikel-Nr. Part-No.
MG 5-LH	5	Ø 4 · 5 · 6 · 8 · 10 mm	1129 13 30005



MG 10-LH



MG 5-LH

SPIRALBOHRER
TWIST DRILLS

TURBO Spiralbohrer DIN 338 HSS-G, mit Zentrierspitze
TURBO Twist drills DIN 338 HSS-G, with centering-tip



TURBO ...mit Zentrierspitze
...with centering-tip



- Innovative Mehrfasen-Schneide ab 3,0 mm Ø
- Kreisrunde Bohrungen mit gratfreien Lochrändern
- Sauberes Anbohren durch selbstzentrierende Spitze
- Die spezielle Zentrierspitze garantiert einen höheren Bohrfortschritt
- New-Multi-Facet-Point-angle starting from 3,0 mm Ø
- Clean round holes without burr
- Precise centering due to self-centering tip
- Special centering-tip guarantees faster drilling rate



- Hohe Stabilität durch verstärkten Kern
- Reinforced web for high stability



- 3-Flächenschaft ab Ø 5,0 mm für optimale Kraftübertragung
- Triangle-shank for sizes above Ø 5,0 mm for optimum power transmission

Geeignet für / suitable for:

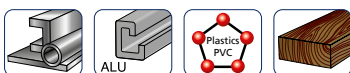

TURBO Spiralbohrer DIN 338 HSS-G, mit Zentrierspitze
TURBO Twist drills DIN 338 HSS-G, with centering-tip



Code 1201



Code	P			M	K	N		S
	1.1 - 2.1	3.1 - 4.1	5.1	1.1 - 2.1	1.1 - 4.2	1.1 - 1.6	2.1 - 2.6	4.2
1201	☉	☉		☉		☉	☉	☉

Für saubere kreisrunde Bohrungen in Stahl, Eisen, Buntmetall, Aluminium, Kunststoffe und Holz. **Besonders gut geeignet für Bohrarbeiten mit Akkuschaubern!**

For clean round holes in steel, iron, non ferrous metals, aluminium, plastics and wood. **Especially suitable for working with cordless machines!**

Ø d mm	L 1 mm	L 2 mm	📏	Artikel-Nr. Part-No.
1,0	34	12	10	1201 03 00100
1,5	40	18	10	1201 03 00150
2,0	49	24	10	1201 03 00200
2,5	57	30	10	1201 03 00250
3,0	61	33	10	1201 03 00300
3,1	65	36	10	1201 03 00310
3,2	65	36	10	1201 03 00320
3,3	65	36	10	1201 03 00330
3,5	70	39	10	1201 03 00350
4,0	75	43	10	1201 03 00400
4,1	75	43	10	1201 03 00410
4,2	75	43	10	1201 03 00420
4,5	80	47	10	1201 03 00450
4,8	86	52	10	1201 03 00480
5,0	86	52	10	1201 03 00500
5,1	86	52	10	1201 03 00510
5,2	86	52	10	1201 03 00520

Ø d mm	L 1 mm	L 2 mm	📏	Artikel-Nr. Part-No.
5,5	93	57	10	1201 03 00550
6,0	93	57	10	1201 03 00600
6,5	101	63	10	1201 03 00650
6,8	109	69	10	1201 03 00680
7,0	109	69	10	1201 03 00700
7,5	109	69	10	1201 03 00750
8,0	117	75	10	1201 03 00800
8,5	117	75	10	1201 03 00850
9,0	125	81	10	1201 03 00900
9,5	125	81	10	1201 03 00950
10,0	133	87	10	1201 03 01000
10,5	133	87	5	1201 03 01050
11,0	142	94	5	1201 03 01100
11,5	142	94	5	1201 03 01150
12,0	151	101	5	1201 03 01200
12,5	151	101	5	1201 03 01250
13,0	151	101	5	1201 03 01300

BC ABS-Boxen / BC ABS-Boxes

Bezeichnung Description	Teile Pieces	Inhalt Content	Artikel-Nr. Part-No.
KG 10-TCR	19	Ø 1,0 – 10,0 mm x 0,5 mm	1201 13 30019
KG 13-TCR	25	Ø 1,0 – 13,0 mm x 0,5 mm	1201 13 30025

BC Multi-Pack / BC Multi-Pack

Bezeichnung Description	Teile Pieces	Inhalt Content	Artikel-Nr. Part-No.
MG 5-TCR	5	Ø 4 · 5 · 6 · 8 · 10 mm	1201 13 30005



KG 10-TCR



MG 5-TCR



SPIRALBOHRER
TWIST DRILLS

TURBO STEP Spiralbohrer DIN 338 HSS-G, mit Stufengeometrie
TURBO STEP Twist drills DIN 338 HSS-G, with step geometry

TURBO STEP ...mit Stufengeometrie
 ...with step geometry



- Innovative Stufengeometrie ab Ø 2,5 mm
- Präzise, kreisrunde Bohrungen mit gratfreien Lochrändern
- Sauberes Anbohren durch selbstzentrierende Spitze
- Besonders schneller Bohrfortschritt
- Innovative step geometry from Ø 2,5 mm
- Precise and clean round holes without burr
- Clean drilling start due to self-centering tip
- Very fast drilling progress



- Dampfangelassene Fase erhöht die Verschleissfestigkeit
- Steam tempered land increases the wear resistance



- 3-Flächenschaft ab Ø 4,0 mm für optimale Kraftübertragung
- Triangle-shank for sizes above Ø 4,0 mm for optimum power transmission



TURBO STEP



- Standard HSS-Bohrer
- Standard HSS twist drill

Geeignet für / suitable for:



SPIRALBOHRER
TWIST DRILLS

TURBO STEP Spiralbohrer DIN 338 HSS-G, mit Stufengeometrie
TURBO STEP Twist drills DIN 338 HSS-G, with step geometry



Code 1202



Code	P			M	K	N		S
	1.1 - 2.1	3.1 - 4.1	5.1	1.1 - 2.1	1.1 - 4.2	1.1 - 1.6	2.1 - 2.6	4.2
1202	☉	☉		☉	☉	☉	☉	☉

- Perfekt für Akkuschauber / Bohrmaschine
- Erheblich schneller als normale Spiralbohrer
- Vereinfachtes Aufbohren bestehender Bohrlöcher
- Ideal zum Ausbohren von Bolzen oder Nieten

Universell einsetzbar in Stahl < 1.000 N/mm², Gusswerkstoffe, Aluminium, Kunststoffe, Hart- und Weichholz.

- Perfect for use with cordless / corded machines
- Significantly faster than normal twist drills
- Simplified drilling of existing drill holes
- Ideal for drilling out bolts or rivets

Epecially suitable for steel < 1.000 N/mm² (31 HRC), cast materials, aluminium, plastics, hard- and softwood.

Ø d mm	L 1 mm	L 2 mm	📏	Artikel-Nr. Part-No.	📏	Artikel-Nr. Part-No.
1,0	34	12	10	1202 03 00100	1	1202 07 00100
1,5	40	18	10	1202 03 00150	1	1202 07 00150
2,0	49	24	10	1202 03 00200	1	1202 07 00200
2,5	57	30	10	1202 03 00250	1	1202 07 00250
3,0	61	33	10	1202 03 00300	1	1202 07 00300
3,2	65	36	10	1202 03 00320	1	1202 07 00320
3,3	65	36	10	1202 03 00330	1	1202 07 00330
3,5	70	39	10	1202 03 00350	1	1202 07 00350
4,0	75	43	10	1202 03 00400	1	1202 07 00400
4,2	75	43	10	1202 03 00420	1	1202 07 00420
4,5	80	47	10	1202 03 00450	1	1202 07 00450
4,9	86	52	10	1202 03 00490	1	1202 07 00490
5,0	86	52	10	1202 03 00500	1	1202 07 00500
5,2	86	52	10	1202 03 00520	1	1202 07 00520
5,5	93	57	10	1202 03 00550	1	1202 07 00550
6,0	93	57	10	1202 03 00600	1	1202 07 00600
6,5	101	63	10	1202 03 00650	1	1202 07 00650
6,8	109	69	10	1202 03 00680	1	1202 07 00680
7,0	109	69	10	1202 03 00700	1	1202 07 00700
7,5	109	69	10	1202 03 00750	1	1202 07 00750
8,0	117	75	10	1202 03 00800	1	1202 07 00800
8,5	117	75	10	1202 03 00850	1	1202 07 00850
9,0	125	81	10	1202 03 00900	1	1202 07 00900
9,5	125	81	10	1202 03 00950	1	1202 07 00950
10,0	133	87	10	1202 03 01000	1	1202 07 01000
10,2	133	87	5	1202 03 01020	1	1202 07 01020
10,5	133	87	5	1202 03 01050	1	1202 07 01050
11,0	142	94	5	1202 03 01100	1	1202 07 01100
11,5	142	94	5	1202 03 01150	1	1202 07 01150
12,0	151	101	5	1202 03 01200	1	1202 07 01200
12,5	151	101	5	1202 03 01250	1	1202 07 01250
13,0	151	101	5	1202 03 01300	1	1202 07 01300

BC ABS-Boxen / BC ABS-Boxes

Bezeichnung Description	Teile Pieces	Inhalt Content	Artikel-Nr. Part-No.
KG 10 T-STEP	19	Ø 1,0 – 10,0 mm x 0,5 mm	1202 13 30019
KG 24 T-STEP	24	Ø 1,0 – 10,5 mm x 0,5 mm + Ø 3,3 · 4,2 · 6,8 · 10,2 mm	1202 13 30024
KG 13 T-STEP	25	Ø 1,0 – 13,0 mm x 0,5 mm	1202 13 30025



BC Multi-Pack / BC Multi-Pack

Bezeichnung Description	Teile Pieces	Inhalt Content	Artikel-Nr. Part-No.
MG 5 T-STEP	5	Ø 4 · 5 · 6 · 8 · 10 mm	1202 13 30005



SPIRALBOHRER
TWIST DRILLS

TURBO STEP DIN 1897 HSS-G, mit Stufengeometrie und reduziertem Schaft
TURBO STEP DIN 1897 HSS-G, with step geometry and reduced shank

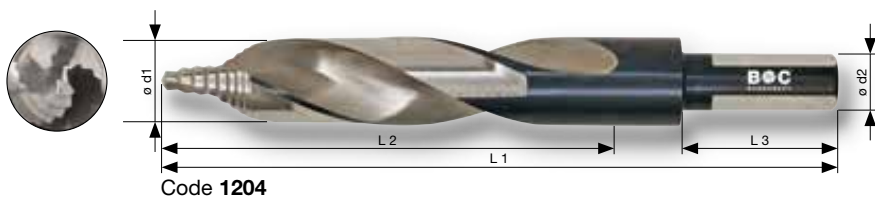

Code	P			M	K	N		S
	1.1 - 2.1	3.1 - 4.1	5.1	1.1 - 2.1	1.1 - 4.2	1.1 - 1.6	2.1 - 2.6	4.2
1204								

- Perfekt für Akkuschauber / Bohrmaschine
- Erheblich schneller als normale Spiralbohrer
- Vereinfachtes Aufbohren bestehender Bohrlöcher

- Perfect for use with cordless / corded machines
- Significantly faster than normal twist drills
- Simplified drilling of existing boreholes

Universell einsetzbar in Stahl < 1.000 N/mm², Gusswerkstoffe, Aluminium, Kunststoffe, Hart- und Weichholz.

Epecially suitable for steel < 1.000 N/mm² (31 HRC), cast materials, aluminium, plastics, hard- and softwood.

Ø d1 mm	L 1 mm	L 2 mm	Ø d2 mm	L 3 mm		Artikel-Nr. Part-No.
13,5	107	61	12,7	29	1	1204 03 01350
14,0	107	61	12,7	29	1	1204 03 01400
14,5	111	65	12,7	29	1	1204 03 01450
15,0	111	65	12,7	29	1	1204 03 01500
15,5	115	69	12,7	29	1	1204 03 01550
16,0	115	69	12,7	29	1	1204 03 01600

TURBO STEP INOX



Code 1203
Seite / Page 67



NEW!

Seite / Page 318



- Schneidpaste
- Schneidwachs
- Schneidgel
- Schneidöl
- Schneidschaum

- Cutting paste
- Cutting wax
- Cutting gel
- Cutting oil
- Cutting foam

Spiralbohrer für ALU DIN 338 HSS-G Typ W geschliffen, Kreuzanschleiff

Twist drills for ALU DIN 338 HSS-G type W fully ground, split point

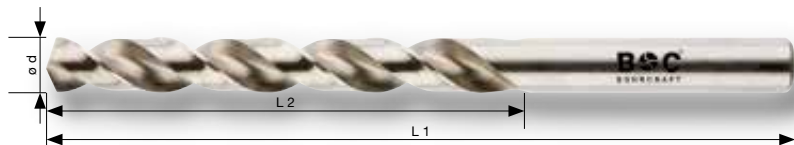

Code 1127



Code	P			M	K	N			S
	1.1 - 2.1	3.1 - 4.1	5.1	1.1 - 4.1	1.1 - 4.2	1.1 - 1.6	2.1	2.2 - 2.6	4.2
1127						⊗	⊗		⊗

Spiralbohrer für weiche, langspanende und zähe Werkstoffe wie Aluminium, Kupfer oder weiche Kunststoffe.

Twist drill for long chipping and tough materials such as aluminium, copper or soft plastic.

Ø d mm	L 1 mm	L 2 mm		Artikel-Nr. Part-No.
2,0	49	24	1	1127 03 00200
2,5	57	30	1	1127 03 00250
3,0	61	33	1	1127 03 00300
3,5	70	39	1	1127 03 00350
4,0	75	43	1	1127 03 00400
4,2	75	43	1	1127 03 00420
4,5	80	47	1	1127 03 00450
5,0	86	52	1	1127 03 00500
5,5	93	57	1	1127 03 00550
6,0	93	57	1	1127 03 00600
6,5	101	63	1	1127 03 00650
7,0	109	69	1	1127 03 00700
7,5	109	69	1	1127 03 00750
8,0	117	75	1	1127 03 00800
8,5	117	75	1	1127 03 00850
9,0	125	81	1	1127 03 00900
9,5	125	81	1	1127 03 00950
10,0	133	87	1	1127 03 01000
10,5	133	87	1	1127 03 01050
11,0	142	94	1	1127 03 01100
11,5	142	94	1	1127 03 01150
12,0	151	101	1	1127 03 01200
12,5	151	101	1	1127 03 01250
13,0	151	101	1	1127 03 01300

BC Multi-Pack / BC Multi-Pack

Bezeichnung Description	Teile Pieces	Inhalt Content	Artikel-Nr. Part-No.
MG 5-ALU	5	Ø 4 · 5 · 6 · 8 · 10 mm	1127 13 30005



MG 5-ALU

Spiralbohrer für **MESSING DIN 338 HSS-G Typ H geschliffen**
Twist drills for **BRASS DIN 338 HSS-G type H fully ground**



Code 1128

DIN 338 **HSS** G **Typ** H **MESSING BRASS** 118° **5xD**

Code	P			M	K	N			S	
	1.1 - 2.1	3.1 - 4.1	5.1	1.1 - 4.1	1.1 - 4.2	1.1 - 1.6	2.2 - 2.6	3.1 - 3.2	4.2	1.1 - 2.6
1128							⊕	⊕	⊕	

Spiralbohrer für harte, kurzspanende, spröde und zähnharte Werkstoffe wie Stahl, Hartkunststoff, Plexiglas oder Schichtpressstoffe.

Twist drill for hard, short chipping, brittle and tough materials such as steel, hard plastics, acrylic glass or laminate.

Ø d mm	L 1 mm	L 2 mm		Artikel-Nr. Part-No.
2,0	49	24	1	1128 03 00200
2,5	57	30	1	1128 03 00250
3,0	61	33	1	1128 03 00300
3,2	65	36	1	1128 03 00320
3,5	70	39	1	1128 03 00350
4,0	75	43	1	1128 03 00400
4,5	80	47	1	1128 03 00450
4,8	86	52	1	1128 03 00480
5,0	86	52	1	1128 03 00500
5,2	86	52	1	1128 03 00520
5,5	93	57	1	1128 03 00550
6,0	93	57	1	1128 03 00600
6,5	101	63	1	1128 03 00650
7,0	109	69	1	1128 03 00700
7,5	109	69	1	1128 03 00750
8,0	117	75	1	1128 03 00800
8,5	117	75	1	1128 03 00850
9,0	125	81	1	1128 03 00900
9,5	125	81	1	1128 03 00950
10,0	133	87	1	1128 03 01000
10,5	133	87	1	1128 03 01050
11,0	142	94	1	1128 03 01100
11,5	142	94	1	1128 03 01150
12,0	151	101	1	1128 03 01200
12,5	151	101	1	1128 03 01250
13,0	151	101	1	1128 03 01300



SPIRALBOHRER
TWIST DRILLS

Spiralbohrer für KUNSTSTOFFE DIN 338 HSS-G Typ HK geschliffen

Twist drills for SYNTHETIC MATERIALS DIN 338 HSS-G type HK fully ground

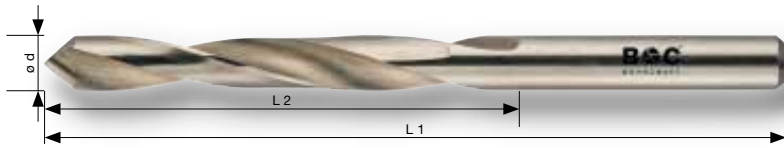

Code 1131



Code	P			M	K	N			S	
	1.1 - 2.1	3.1 - 4.1	5.1	1.1 - 4.1	1.1 - 4.2	1.1 - 1.6	2.1 - 2.6	4.1	4.2	1.1 - 2.6
1131										

Spezialbohrer für Bakelit (ohne Füllstoffe), HPL, Plexiglas, Hartgummi, Eternit, Pertinax, Duroplaste.

Besonders gut geeignet für ausrissfreie Bohrungen in HPL-Fassadenplatten!

Special drill for bakelite, HPL, acrylic glass, hard rubber, eternit, pertinax, thermoset materials.

Especially suitable for splinter free drilling of HPL panels.

Ø d mm	L 1 mm	L 2 mm		Artikel-Nr. Part-No.
2,0	49	24	1	1131 03 00200
2,5	57	30	1	1131 03 00250
3,0	61	33	1	1131 03 00300
3,5	70	39	1	1131 03 00350
4,0	75	43	1	1131 03 00400
4,5	80	47	1	1131 03 00450
5,0	86	52	1	1131 03 00500
5,5	93	57	1	1131 03 00550
6,0	93	57	1	1131 03 00600
6,5	101	63	1	1131 03 00650
7,0	109	69	1	1131 03 00700
7,5	109	69	1	1131 03 00750
8,0	117	75	1	1131 03 00800
8,5	117	75	1	1131 03 00850
9,0	125	81	1	1131 03 00900
9,5	125	81	1	1131 03 00950
10,0	133	87	1	1131 03 01000

BC Multi-Pack / BC Multi-Pack

Bezeichnung Description	Teile Pieces	Inhalt Content	Artikel-Nr. Part-No.
HK 5	5	Ø 4 · 5 · 6 · 8 · 10 mm	1131 13 30005

BC ABS Box / BC ABS Box

Bezeichnung Description	Teile Pieces	Inhalt Content	Artikel-Nr. Part-No.
KG 10 HK	17	Ø 2,0 – 10,0 mm x 0,5 mm	1131 13 30017



KG 10 HK



HK 5

SPIRALBOHRER TWIST DRILLS

Spiralbohrer DIN 338 HSS-E (Co5) kobaltlegiert, Kreuzanschliff
Twist drills DIN 338 HSS-E (Co5) cobalt alloyed, split point

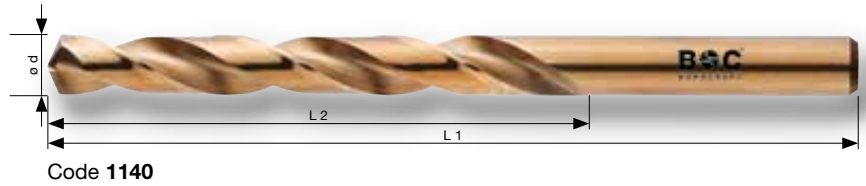

DIN 338
HSS-E Co5
Typ N
VA INOX
135°
SPLIT POINT
5xD

Code	P			M	K	N			S
	1.1 - 2.1	3.1 - 4.1	5.1	1.1 - 2.1	1.1 - 4.2	1.1 - 1.6	2.1 - 2.6	4.2	1.1 - 2.6
1140	☉	☉		☉	☉	☉	☉	☉	

Spiralbohrer mit höherer Warmhärtebeständigkeit, zum Bohren von rost-, säure- und hitzebeständigen Stählen.

Twist drill with higher heat resistance, for drilling stainless steels and heat resistant steels.

Ø d1 mm	L 1 mm	L 2 mm		Artikel-Nr. Part-No.		Artikel-Nr. Part-No.
1,0	34	12	10	1140 01 00100	1	1140 07 00100
1,1	36	14	10	1140 01 00110	-	-
1,2	38	16	10	1140 01 00120	-	-
1,3	38	16	10	1140 01 00130	-	-
1,4	38	16	10	1140 01 00140	-	-
1,5	40	18	10	1140 01 00150	1	1140 07 00150
1,6	43	20	10	1140 01 00160	-	-
1,7	43	20	10	1140 01 00170	-	-
1,8	46	23	10	1140 01 00180	-	-
1,9	46	23	10	1140 01 00190	-	-
2,0	49	24	10	1140 01 00200	1	1140 07 00200
2,1	49	24	10	1140 01 00210	-	-
2,2	53	27	10	1140 01 00220	-	-
2,3	53	27	10	1140 01 00230	-	-
2,4	57	30	10	1140 01 00240	-	-
2,5	57	30	10	1140 01 00250	1	1140 07 00250
2,6	57	30	10	1140 01 00260	-	-
2,7	61	33	10	1140 01 00270	-	-
2,8	61	33	10	1140 01 00280	-	-
2,9	61	33	10	1140 01 00290	-	-
3,0	61	33	10	1140 01 00300	1	1140 07 00300
3,1	65	36	10	1140 01 00310	1	1140 07 00310
3,2	65	36	10	1140 01 00320	1	1140 07 00320
3,3	65	36	10	1140 01 00330	1	1140 07 00330
3,4	70	39	10	1140 01 00340	-	-
3,5	70	39	10	1140 01 00350	1	1140 07 00350
3,6	70	39	10	1140 01 00360	-	-
3,7	70	39	10	1140 01 00370	-	-
3,8	75	43	10	1140 01 00380	-	-
3,9	75	43	10	1140 01 00390	-	-
4,0	75	43	10	1140 01 00400	1	1140 07 00400
4,1	75	43	10	1140 01 00410	1	1140 07 00410
4,2	75	43	10	1140 01 00420	1	1140 07 00420
4,3	80	47	10	1140 01 00430	-	-
4,4	80	47	10	1140 01 00440	-	-
4,5	80	47	10	1140 01 00450	1	1140 07 00450
4,6	80	47	10	1140 01 00460	-	-
4,7	80	47	10	1140 01 00470	-	-
4,8	86	52	10	1140 01 00480	1	1140 07 00480
4,9	86	52	10	1140 01 00490	-	-
5,0	86	52	10	1140 01 00500	1	1140 07 00500
5,1	86	52	10	1140 01 00510	1	1140 07 00510
5,2	86	52	10	1140 01 00520	1	1140 07 00520
5,3	86	52	10	1140 01 00530	-	-
5,4	93	57	10	1140 01 00540	-	-
5,5	93	57	10	1140 01 00550	1	1140 07 00550
5,6	93	57	10	1140 01 00560	-	-
5,7	93	57	10	1140 01 00570	-	-
5,8	93	57	10	1140 01 00580	-	-
5,9	93	57	10	1140 01 00590	-	-
6,0	93	57	10	1140 01 00600	1	1140 07 00600
6,1	101	63	10	1140 01 00610	-	-
6,2	101	63	10	1140 01 00620	-	-
6,3	101	63	10	1140 01 00630	-	-





SPIRALBOHRER
TWIST DRILLS

Spiralbohrer DIN 338 HSS-E (Co5) kobaltlegiert, Kreuzanschliff
 Twist drills DIN 338 HSS-E (Co5) cobalt alloyed, split point



Code 1140

Ø d1 mm	L 1 mm	L 2 mm		Artikel-Nr. Part-No.		Artikel-Nr. Part-No.
6,4	101	63	10	1140 01 00640	-	-
6,5	101	63	10	1140 01 00650	1	1140 07 00650
6,6	101	63	10	1140 01 00660	-	-
6,7	101	63	10	1140 01 00670	-	-
6,8	109	69	10	1140 01 00680	1	1140 07 00680
6,9	109	69	10	1140 01 00690	-	-
7,0	109	69	10	1140 01 00700	1	1140 07 00700
7,1	109	69	10	1140 01 00710	-	-
7,2	109	69	10	1140 01 00720	-	-
7,3	109	69	10	1140 01 00730	-	-
7,4	109	69	10	1140 01 00740	-	-
7,5	109	69	10	1140 01 00750	1	1140 07 00750
7,6	117	75	10	1140 01 00760	-	-
7,7	117	75	10	1140 01 00770	-	-
7,8	117	75	10	1140 01 00780	-	-
7,9	117	75	10	1140 01 00790	-	-
8,0	117	75	10	1140 01 00800	1	1140 07 00800
8,1	117	75	10	1140 01 00810	-	-
8,2	117	75	10	1140 01 00820	-	-
8,3	117	75	10	1140 01 00830	-	-
8,4	117	75	10	1140 01 00840	-	-
8,5	117	75	10	1140 01 00850	1	1140 07 00850
8,6	125	81	10	1140 01 00860	-	-
8,7	125	81	10	1140 01 00870	-	-
8,8	125	81	10	1140 01 00880	-	-
8,9	125	81	10	1140 01 00890	-	-
9,0	125	81	10	1140 01 00900	1	1140 07 00900
9,1	125	81	10	1140 01 00910	-	-
9,2	125	81	10	1140 01 00920	-	-
9,3	125	81	10	1140 01 00930	-	-
9,4	125	81	10	1140 01 00940	-	-
9,5	125	81	10	1140 01 00950	1	1140 07 00950
9,6	133	87	10	1140 01 00960	-	-
9,7	133	87	10	1140 01 00970	-	-
9,8	133	87	10	1140 01 00980	-	-
9,9	133	87	10	1140 01 00990	-	-
10,0	133	87	10	1140 01 01000	1	1140 07 01000
10,2	133	87	5	1140 01 01020	1	1140 07 01020
10,5	133	87	5	1140 01 01050	1	1140 07 01050
11,0	142	94	5	1140 01 01100	1	1140 07 01100
11,2	142	94	5	1140 01 01120	-	-
11,5	142	94	5	1140 01 01150	1	1140 07 01150
12,0	151	101	5	1140 01 01200	1	1140 07 01200
12,5	151	101	5	1140 01 01250	1	1140 07 01250
13,0	151	101	5	1140 01 01300	1	1140 07 01300
13,5	160	108	5	1140 01 01350	-	-
14,0	160	108	5	1140 01 01400	-	-
14,5	169	114	5	1140 01 01450	-	-
15,0	169	114	5	1140 01 01500	-	-
15,5	178	120	5	1140 01 01550	-	-
16,0	178	120	5	1140 01 01600	-	-

SPIRALBOHRER
TWIST DRILLS

Spiralbohrer DIN 338 HSS-E (Co5) kobaltlegiert, Kreuzanschliff
Twist drills DIN 338 HSS-E (Co5) cobalt alloyed, split point

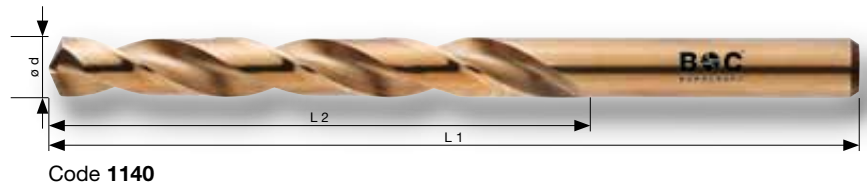

Code 1140

BC ABS-Boxen / BC ABS-Boxes

Bezeichnung Description	Teile Pieces	Inhalt Content	Artikel-Nr. Part-No.
KE 10	19	Ø 1,0 – 10,0 mm x 0,5 mm	1140 13 30019
KE 13	25	Ø 1,0 – 13,0 mm x 0,5 mm	1140 13 30025
KE 24	24	Ø 1,0 – 10,5 mm x 0,5 mm + Ø 3,3 · 4,2 · 6,8 · 10,2 mm	1140 13 30024
KE 591	51	Ø 1,0 – 6,0 mm x 0,1 mm	1140 13 30050
KE 601	41	Ø 6,0 – 10,0 mm x 0,1 mm	1140 13 30041



BC Grip-Box / BC Grip-Box

Bezeichnung Description	Teile Pieces	Inhalt Content	Artikel-Nr. Part-No.
VE 10	19	Ø 1,0 – 10,0 mm x 0,5 mm	1140 14 10119



BC Industrie-Kassetten / BC Metal-Boxes

Bezeichnung Description	Teile Pieces	Inhalt Content	Artikel-Nr. Part-No.
ME 10	19	Ø 1,0 – 10,0 mm x 0,5 mm	1140 13 10019
ME 13	25	Ø 1,0 – 13,0 mm x 0,5 mm	1140 13 10025
ME 24	24	Ø 1,0 – 10,5 mm x 0,5 mm + Ø 3,3 · 4,2 · 6,8 · 10,2 mm	1140 14 10024
ME 591	50	Ø 1,0 – 5,9 mm x 0,1 mm	1140 14 10050
ME 601	41	Ø 6,0 – 10,0 mm x 0,1 mm	1140 14 10041
ME 65	65	Ø 1,0 – 6,0 mm x 0,5 mm = 5 St. / pcs. + Ø 3,3 · 4,2 mm = 5 St. / pcs.	1140 13 10065
ME 70	70	Ø 1,0 – 5,0 mm x 0,5 mm = 5 St. / pcs. Ø 5,5 – 7,5 mm x 0,5 mm = 3 St. / pcs. Ø 8,0 – 10,0 mm x 0,5 mm = 2 St. / pcs.	1140 14 10070
ME 170	170	Ø 1,0 – 10,0 mm x 0,5 mm Ø 1,0 – 8,0 mm = 10 St. / pcs. Ø 8,5 – 10,0 mm = 5 St. / pcs.	1140 14 10170
ME 220	220	Ø 1,0 – 13,0 mm x 0,5 mm + 3,3 / 4,2 mm Ø 1,0 – 8,0 mm = 10 St. / pcs. Ø 8,5 – 13,0 mm = 5 St. / pcs.	1140 14 20220



BC Kunststoff-Kassette / BC Plastic-Box

Bezeichnung Description	Teile Pieces	Inhalt Content	Display 	Artikel-Nr. Part-No.
PE 6	6	Ø 2 · 3 · 4 · 5 · 6 · 8 mm	18	1140 14 30006



Spiralbohrer DIN 338 HSS-E (Co5) kobaltlegiert, mit reduziertem Schaft
 Twist drills DIN 338 HSS-E (Co5) cobalt alloyed, with reduced shank

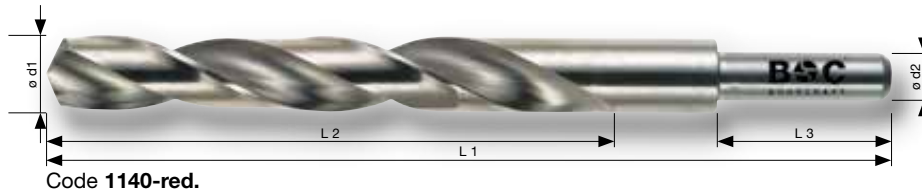

Code 1140-red.



Code	P			M	K	N		S
	1.1 - 2.1	3.1 - 4.1	5.1	1.1 - 2.1	1.1 - 4.2	1.1 - 1.6	2.1 - 2.6	4.2
1140	☉	☉		☉	☉	☉	☉	☉

Spiralbohrer mit höherer Warmhärtebeständigkeit, zum Bohren von rost-, säure- und hitzebeständigen Stählen.

Twist drill with higher heat resistance, for drilling stainless steels and heat resistant steels.

Ø d1 mm	L 1 mm	L 2 mm	Ø d2 mm	L 3 mm		Artikel-Nr. Part-No.
11,0	142	94	10	30	1	1140 03 11100
12,0	151	101	10	30	1	1140 03 11200
13,0	151	101	10	30	1	1140 03 11300
13,5	160	108	10	30	1	1140 03 11350
14,0	160	108	10	30	1	1140 03 11400
14,5	169	114	10	30	1	1140 03 11450
15,0	169	114	10	30	1	1140 03 11500
15,5	178	120	10	30	1	1140 03 11550
16,0	178	120	10	30	1	1140 03 11600
16,5	184	125	13	35	1	1140 03 11650
17,0	184	125	13	35	1	1140 03 11700
17,5	191	130	13	35	1	1140 03 11750
18,0	191	130	13	35	1	1140 03 11800
18,5	198	135	13	35	1	1140 03 11850
19,0	198	135	13	35	1	1140 03 11900
19,5	205	140	13	35	1	1140 03 11950
20,0	205	140	13	35	1	1140 03 12000

SPIRALBOHRER
TWIST DRILLS

TURBO STEP INOX Spiralbohrer DIN 338 HSS-E, mit Stufengeometrie
TURBO STEP INOX twist drills DIN 338 HSS-E, with step geometry



Code 1203



Code	P			M	K	N		S
	1.1 - 2.1	3.1 - 4.1	5.1	1.1 - 2.1	1.1 - 4.2	1.1 - 1.6	2.1 - 2.6	4.2
1203	☉	☉	☉	☉	☉	☉	☉	☉

- Perfekt für Akkuschrauber / Bohrmaschine
- Erheblich schneller als normale Spiralbohrer
- Vereinfachtes Aufbohren bestehender Bohrlöcher
- Ideal zum Ausbohren von Bolzen oder Nieten

- Perfect for use with cordless / corded machines
- Significantly faster than normal twist drills
- Simplified drilling of existing drill holes
- Ideal for drilling out bolts or rivets

Universell einsetzbar in Stahl und Edelstahl bis 1.200 N/mm², Gusswerkstoffe, Aluminium, Kunststoffe (z.B. Acrylglas), Hart- und Weichholz.

Especially suitable for steel and stainless steel up to 1.200 N/mm² (38 HRC), cast materials, aluminium, plastics (e.g. acrylic glass), hard- and softwood.

Ø d mm	L 1 mm	L 2 mm		Artikel-Nr. Part-No.		Artikel-Nr. Part-No.
1,0	34	12	10	1203 03 00100	1	1203 07 00100
1,5	40	18	10	1203 03 00150	1	1203 07 00150
2,0	49	24	10	1203 03 00200	1	1203 07 00200
2,5	57	30	10	1203 03 00250	1	1203 07 00250
3,0	61	33	10	1203 03 00300	1	1203 07 00300
3,2	65	36	10	1203 03 00320	1	1203 07 00320
3,3	65	36	10	1203 03 00330	1	1203 07 00330
3,5	70	39	10	1203 03 00350	1	1203 07 00350
4,0	75	43	10	1203 03 00400	1	1203 07 00400
4,2	75	43	10	1203 03 00420	1	1203 07 00420
4,5	80	47	10	1203 03 00450	1	1203 07 00450
4,9	86	52	10	1203 03 00490	1	1203 07 00490
5,0	86	52	10	1203 03 00500	1	1203 07 00500
5,2	86	52	10	1203 03 00520	1	1203 07 00520
5,5	93	57	10	1203 03 00550	1	1203 07 00550
6,0	93	57	10	1203 03 00600	1	1203 07 00600
6,5	101	63	10	1203 03 00650	1	1203 07 00650
6,8	109	69	10	1203 03 00680	1	1203 07 00680
7,0	109	69	10	1203 03 00700	1	1203 07 00700
7,5	109	69	10	1203 03 00750	1	1203 07 00750
8,0	117	75	10	1203 03 00800	1	1203 07 00800
8,5	117	75	10	1203 03 00850	1	1203 07 00850
9,0	125	81	10	1203 03 00900	1	1203 07 00900
9,5	125	81	10	1203 03 00950	1	1203 07 00950
10,0	133	87	10	1203 03 01000	1	1203 07 01000
10,2	133	87	5	1203 03 01020	1	1203 07 01020
10,5	133	87	5	1203 03 01050	1	1203 07 01050
11,0	142	94	5	1203 03 01100	1	1203 07 01100
11,5	142	94	5	1203 03 01150	1	1203 07 01150
12,0	151	101	5	1203 03 01200	1	1203 07 01200
12,5	151	101	5	1203 03 01250	1	1203 07 01250
13,0	151	101	5	1203 03 01300	1	1203 07 01300

BC ABS-Boxen / BC ABS-Boxes

Bezeichnung Description	Teile Pieces	Inhalt Content	Artikel-Nr. Part-No.
KE 10 T-STEP INOX	19	Ø 1,0 – 10,0 mm x 0,5 mm	1203 13 30019
KE 24 T-STEP INOX	24	Ø 1,0 – 10,5 mm x 0,5 mm + Ø 3,3 · 4,2 · 6,8 · 10,2 mm	1203 13 30024
KE 13 T-STEP INOX	25	Ø 1,0 – 13,0 mm x 0,5 mm	1203 13 30025



BC Multi-Pack / BC Multi-Pack

Bezeichnung Description	Teile Pieces	Inhalt Content	Artikel-Nr. Part-No.
ME 5 T-STEP INOX	5	Ø 4 · 5 · 6 · 8 · 10 mm	1203 13 30005



SPIRALBOHRER
TWIST DRILLS

Spiralbohrer DIN 338 HSS-E (Co5) Typ VA/Ti kobaltlegiert, Kreuzanschleiff
Twist drills DIN 338 HSS-E (Co5) type VA/Ti cobalt alloyed, split point

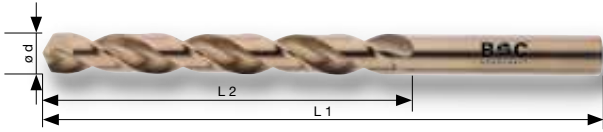

Code 1141



Code 1143 TiAlN



Code	P			M	K	N		S
	1.1 - 2.1	3.1 - 4.1	5.1	1.1 - 4.1	1.1 - 4.2	1.1 - 1.6	2.1 - 2.6	4.2
1141	⊗	⊗	⊗	⊗	⊗	⊗	⊗	⊗
1143	⊗	⊗	⊗	⊗	⊗			⊗

Spezialbohrer mit hoher Bruchsicherheit durch verstärkte Kerndicke. Für Werkstoffe mit einer Festigkeit bis 1.200 N/mm².

Kerndicke ist stärker als normal!

Special drill with high security against fracture due to reinforced web thickness. Suitable for materials with tensile strength up to 1.200 N/mm² (38 HRC).

Web thickness bigger than normal!

Ø d mm	L 1 mm	L 2 mm	📏	TiAlN	
				Artikel-Nr. Part-No.	Artikel-Nr. Part-No.
0,6	24	7	10	1141 03 00060	-
0,7	28	9	10	1141 03 00070	-
0,8	30	10	10	1141 03 00080	-
0,9	32	11	10	1141 03 00090	-
1,0	34	12	10	1141 03 00100	-
1,1	36	14	10	1141 03 00110	-
1,2	38	16	10	1141 03 00120	-
1,3	38	16	10	1141 03 00130	-
1,4	40	18	10	1141 03 00140	-
1,5	40	18	10	1141 03 00150	-
1,6	43	20	10	1141 03 00160	-
1,7	43	20	10	1141 03 00170	-
1,8	46	23	10	1141 03 00180	-
1,9	46	23	10	1141 03 00190	-
2,0	49	24	10	1141 03 00200	1143 03 00200
2,1	49	24	10	1141 03 00210	1143 03 00210
2,2	53	27	10	1141 03 00220	1143 03 00220
2,3	53	27	10	1141 03 00230	1143 03 00230
2,4	57	30	10	1141 03 00240	1143 03 00240
2,5	57	30	10	1141 03 00250	1143 03 00250
2,6	57	30	10	1141 03 00260	1143 03 00260
2,7	61	33	10	1141 03 00270	1143 03 00270
2,8	61	33	10	1141 03 00280	1143 03 00280
2,9	61	33	10	1141 03 00290	1143 03 00290
3,0	61	33	10	1141 03 00300	1143 03 00300
3,1	65	36	10	1141 03 00310	1143 03 00310
3,2	65	36	10	1141 03 00320	1143 03 00320
3,3	65	36	10	1141 03 00330	1143 03 00330
3,4	70	39	10	1141 03 00340	1143 03 00340
3,5	70	39	10	1141 03 00350	1143 03 00350
3,6	70	39	10	1141 03 00360	1143 03 00360
3,7	70	39	10	1141 03 00370	1143 03 00370
3,8	70	43	10	1141 03 00380	1143 03 00380
3,9	75	43	10	1141 03 00390	1143 03 00390
4,0	75	43	10	1141 03 00400	1143 03 00400
4,1	75	43	10	1141 03 00410	1143 03 00410
4,2	75	43	10	1141 03 00420	1143 03 00420
4,3	80	47	10	1141 03 00430	1143 03 00430
4,4	80	47	10	1141 03 00440	1143 03 00440
4,5	80	47	10	1141 03 00450	1143 03 00450
4,6	80	47	10	1141 03 00460	1143 03 00460
4,7	80	47	10	1141 03 00470	1143 03 00470
4,8	86	52	10	1141 03 00480	1143 03 00480
4,9	86	52	10	1141 03 00490	1143 03 00490
5,0	86	52	10	1141 03 00500	1143 03 00500
5,1	86	52	10	1141 03 00510	1143 03 00510
5,2	86	52	10	1141 03 00520	1143 03 00520
5,3	86	52	10	1141 03 00530	1143 03 00530
5,4	93	57	10	1141 03 00540	1143 03 00540
5,5	93	57	10	1141 03 00550	1143 03 00550

Ø d mm	L 1 mm	L 2 mm	📏	TiAlN	
				Artikel-Nr. Part-No.	Artikel-Nr. Part-No.
5,6	93	57	10	1141 03 00560	1143 03 00560
5,7	93	57	10	1141 03 00570	1143 03 00570
5,8	93	57	10	1141 03 00580	1143 03 00580
5,9	93	57	10	1141 03 00590	1143 03 00590
6,0	93	57	10	1141 03 00600	1143 03 00600
6,1	101	63	10	1141 03 00610	1143 03 00610
6,2	101	63	10	1141 03 00620	1143 03 00620
6,3	101	63	10	1141 03 00630	1143 03 00630
6,4	101	63	10	1141 03 00640	1143 03 00640
6,5	101	63	10	1141 03 00650	1143 03 00650
6,6	101	63	10	1141 03 00660	1143 03 00660
6,7	101	63	10	1141 03 00670	1143 03 00670
6,8	109	69	10	1141 03 00680	1143 03 00680
6,9	109	69	10	1141 03 00690	1143 03 00690
7,0	109	69	10	1141 03 00700	1143 03 00700
7,1	109	69	5	1141 03 00710	1143 03 00710
7,2	109	69	5	1141 03 00720	1143 03 00720
7,3	109	69	5	1141 03 00730	1143 03 00730
7,4	109	69	5	1141 03 00740	1143 03 00740
7,5	109	69	5	1141 03 00750	1143 03 00750
7,6	117	75	5	1141 03 00760	1143 03 00760
7,7	117	75	5	1141 03 00770	1143 03 00770
7,8	117	75	5	1141 03 00780	1143 03 00780
7,9	117	75	5	1141 03 00790	1143 03 00790
8,0	117	75	5	1141 03 00800	1143 03 00800
8,1	117	75	5	1141 03 00810	1143 03 00810
8,2	117	75	5	1141 03 00820	1143 03 00820
8,3	117	75	5	1141 03 00830	1143 03 00830
8,4	117	75	5	1141 03 00840	1143 03 00840
8,5	117	75	5	1141 03 00850	1143 03 00850
8,6	125	81	5	1141 03 00860	1143 03 00860
8,7	125	81	5	1141 03 00870	1143 03 00870
8,8	125	81	5	1141 03 00880	1143 03 00880
8,9	125	81	5	1141 03 00890	1143 03 00890
9,0	125	81	5	1141 03 00900	1143 03 00900
9,1	125	81	5	1141 03 00910	1143 03 00910
9,2	125	81	5	1141 03 00920	1143 03 00920
9,3	125	81	5	1141 03 00930	1143 03 00930
9,4	125	81	5	1141 03 00940	1143 03 00940
9,5	125	81	5	1141 03 00950	1143 03 00950
9,6	133	87	5	1141 03 00960	1143 03 00960
9,7	133	87	5	1141 03 00970	1143 03 00970
9,8	133	87	5	1141 03 00980	1143 03 00980
9,9	133	87	5	1141 03 00990	1143 03 00990
10,0	133	87	5	1141 03 01000	1143 03 01000
10,1	133	87	5	1141 03 01010	1143 03 01010
10,2	133	87	5	1141 03 01020	1143 03 01020
10,3	133	87	5	1141 03 01030	1143 03 01030
10,4	133	87	5	1141 03 01040	1143 03 01040
10,5	133	87	5	1141 03 01050	1143 03 01050

Spiralbohrer DIN 338 HSS-E (Co5) Typ VA/Ti kobaltlegiert, Kreuzanschliff
Twist drills DIN 338 HSS-E (Co5) type VA/Ti cobalt alloyed, split point

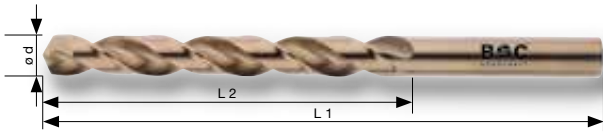

Code 1141



Code 1143 TiALN

Ø d mm	L 1 mm	L 2 mm		TiALN	
				Artikel-Nr. Part-No.	Artikel-Nr. Part-No.
10,6	142	94	5	1141 03 01060	1143 03 01060
10,7	142	94	5	1141 03 01070	1143 03 01070
10,8	142	94	5	1141 03 01080	1143 03 01080
10,9	142	94	5	1141 03 01090	1143 03 01090
11,0	142	94	5	1141 03 01100	1143 03 01100
11,1	142	94	5	1141 03 01110	1143 03 01110
11,2	142	94	5	1141 03 01120	1143 03 01120
11,3	142	94	5	1141 03 01130	1143 03 01130
11,4	142	94	5	1141 03 01140	1143 03 01140
11,5	142	94	5	1141 03 01150	1143 03 01150
11,6	151	101	5	1141 03 01160	1143 03 01160
11,7	151	101	5	1141 03 01170	1143 03 01170
11,8	151	101	5	1141 03 01180	1143 03 01180
11,9	151	101	5	1141 03 01190	1143 03 01190
12,0	151	101	5	1141 03 01200	1143 03 01200
12,1	151	101	5	1141 03 01210	1143 03 01210

Ø d mm	L 1 mm	L 2 mm		TiALN	
				Artikel-Nr. Part-No.	Artikel-Nr. Part-No.
12,2	151	101	5	1141 03 01220	1143 03 01220
12,3	151	101	5	1141 03 01230	1143 03 01230
12,4	151	101	5	1141 03 01240	1143 03 01240
12,5	151	101	5	1141 03 01250	1143 03 01250
12,6	151	101	5	1141 03 01260	1143 03 01260
12,7	151	101	5	1141 03 01270	1143 03 01270
12,8	151	101	5	1141 03 01280	1143 03 01280
12,9	151	101	5	1141 03 01290	1143 03 01290
13,0	151	101	5	1141 03 01300	1143 03 01300
13,5	160	108	1	1141 03 01350	1143 03 01350
14,0	160	108	1	1141 03 01400	1143 03 01400
14,5	169	114	1	1141 03 01450	1143 03 01450
15,0	169	114	1	1141 03 01500	1143 03 01500
15,5	178	120	1	1141 03 01550	1143 03 01550
16,0	178	120	1	1141 03 01600	1143 03 01600

BC ABS-Boxen / BC ABS-Boxes

Bezeichnung Description	Teile Pieces	Inhalt Content	Artikel-Nr. Part-No.
KE 10 Ti	19	Ø 1,0 – 10,0 mm x 0,5 mm	1141 14 30019
KE 13 Ti	25	Ø 1,0 – 13,0 mm x 0,5 mm	1141 14 30025



KE 10 Ti



KE 13 Ti

Mehrbereichsbohrer DIN 338 HSS-E (Co5) Typ U-TL kobaltlegiert, Kreuzanschliff
 Multigrade drills DIN 338 HSS-E (Co5) type U-TL cobalt alloyed, split point

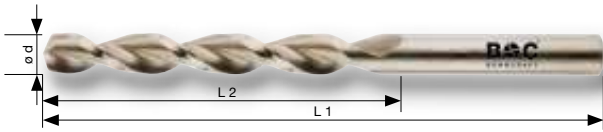

Code 1142



Code 1144 TiAlN



Code	P			M	K	N			S
	1.1 - 2.1	3.1 - 4.1	5.1	1.1 - 2.1	1.1 - 4.2	1.1 - 1.6	2.1 - 2.6	4.2	1.1 - 2.6
1142	⊗	⊗	⊗	⊗	⊗	⊗	⊗	⊗	
1144	⊗	⊗	⊗	⊗	⊗		⊗	⊗	

Mehrbereichsbohrer mit parabolisch geformter Spannanz zur besseren Spanabfuhr. Für Werkstoffe mit einer Festigkeit bis 1.200 N/mm².

Ideal zum Bohren von mittel-, langspannenden und schwer zerspanbaren Werkstoffen. Deckt in weiten Bereichen Typ N, H und W ab!

Multigrade drill with parabolic flute for improved chip removal. Suitable for materials with tensile strength up to 1.200 N/mm² (38 HRC).

Especially suitable for medium, long chipping and hard machinable materials. Covers drill-sectors which should be drilled with Type N, H and W drills!

Ø d mm	L 1 mm	L 2 mm	📏	TiAlN	
				Artikel-Nr. Part-No.	Artikel-Nr. Part-No.
2,0	49	24	10	1142 03 00200	1144 03 00200
2,1	49	24	10	1142 03 00210	1144 03 00210
2,2	53	27	10	1142 03 00220	1144 03 00220
2,3	53	27	10	1142 03 00230	1144 03 00230
2,4	57	30	10	1142 03 00240	1144 03 00240
2,5	57	30	10	1142 03 00250	1144 03 00250
2,6	57	30	10	1142 03 00260	1144 03 00260
2,7	61	33	10	1142 03 00270	1144 03 00270
2,8	61	33	10	1142 03 00280	1144 03 00280
2,9	61	33	10	1142 03 00290	1144 03 00290
3,0	61	33	10	1142 03 00300	1144 03 00300
3,1	65	36	10	1142 03 00310	1144 03 00310
3,2	65	36	10	1142 03 00320	1144 03 00320
3,3	65	36	10	1142 03 00330	1144 03 00330
3,4	70	39	10	1142 03 00340	1144 03 00340
3,5	70	39	10	1142 03 00350	1144 03 00350
3,6	70	39	10	1142 03 00360	1144 03 00360
3,7	70	39	10	1142 03 00370	1144 03 00370
3,8	70	43	10	1142 03 00380	1144 03 00380
3,9	75	43	10	1142 03 00390	1144 03 00390
4,0	75	43	10	1142 03 00400	1144 03 00400
4,1	75	43	10	1142 03 00410	1144 03 00410
4,2	75	43	10	1142 03 00420	1144 03 00420
4,3	80	47	10	1142 03 00430	1144 03 00430
4,4	80	47	10	1142 03 00440	1144 03 00440
4,5	80	47	10	1142 03 00450	1144 03 00450
4,6	80	47	10	1142 03 00460	1144 03 00460
4,7	80	47	10	1142 03 00470	1144 03 00470
4,8	86	52	10	1142 03 00480	1144 03 00480
4,9	86	52	10	1142 03 00490	1144 03 00490
5,0	86	52	10	1142 03 00500	1144 03 00500
5,1	86	52	10	1142 03 00510	1144 03 00510
5,2	86	52	10	1142 03 00520	1144 03 00520
5,3	86	52	10	1142 03 00530	1144 03 00530
5,4	93	57	10	1142 03 00540	1144 03 00540
5,5	93	57	10	1142 03 00550	1144 03 00550
5,6	93	57	10	1142 03 00560	1144 03 00560
5,7	93	57	10	1142 03 00570	1144 03 00570
5,8	93	57	10	1142 03 00580	1144 03 00580
5,9	93	57	10	1142 03 00590	1144 03 00590
6,0	93	57	10	1142 03 00600	1144 03 00600
6,1	101	63	10	1142 03 00610	1144 03 00610
6,2	101	63	10	1142 03 00620	1144 03 00620
6,3	101	63	10	1142 03 00630	1144 03 00630
6,4	101	63	10	1142 03 00640	1144 03 00640
6,5	101	63	10	1142 03 00650	1144 03 00650
6,6	101	63	10	1142 03 00660	1144 03 00660
6,7	101	63	10	1142 03 00670	1144 03 00670

SPIRALBOHRER
TWIST DRILLS

Mehrbereichsbohrer DIN 338 HSS-E (Co5) Typ U-TL kobaltlegiert, Kreuzanschliff
Multigrade drills DIN 338 HSS-E (Co5) type U-TL cobalt alloyed, split point

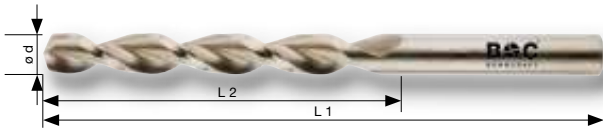

Code 1142



Code 1144 TiALN

Ø d mm	L 1 mm	L 2 mm		TiALN	
				Artikel-Nr. Part-No.	Artikel-Nr. Part-No.
6,8	109	69	10	1142 03 00680	1144 03 00680
6,9	109	69	10	1142 03 00690	1144 03 00690
7,0	109	69	10	1142 03 00700	1144 03 00700
7,1*	109	69	5	1142 03 00710	1144 03 00710
7,2	109	69	5	1142 03 00720	1144 03 00720
7,3	109	69	5	1142 03 00730	1144 03 00730
7,4*	109	69	5	1142 03 00740	1144 03 00740
7,5	109	69	5	1142 03 00750	1144 03 00750
7,6	117	75	5	1142 03 00760	1144 03 00760
7,7	117	75	5	1142 03 00770	1144 03 00770
7,8	117	75	5	1142 03 00780	1144 03 00780
7,9	117	75	5	1142 03 00790	1144 03 00790
8,0	117	75	5	1142 03 00800	1144 03 00800
8,1	117	75	5	1142 03 00810	1144 03 00810
8,2	117	75	5	1142 03 00820	1144 03 00820
8,3	117	75	5	1142 03 00830	1144 03 00830
8,4	117	75	5	1142 03 00840	1144 03 00840
8,5	117	75	5	1142 03 00850	1144 03 00850
8,6	125	81	5	1142 03 00860	1144 03 00860
8,7	125	81	5	1142 03 00870	1144 03 00870
8,8	125	81	5	1142 03 00880	1144 03 00880
8,9	125	81	5	1142 03 00890	1144 03 00890
9,0	125	81	5	1142 03 00900	1144 03 00900
9,1	125	81	5	1142 03 00910	1144 03 00910
9,2	125	81	5	1142 03 00920	1144 03 00920
9,3	125	81	5	1142 03 00930	1144 03 00930
9,4	125	81	5	1142 03 00940	1144 03 00940
9,5	125	81	5	1142 03 00950	1144 03 00950
9,6	133	87	5	1142 03 00960	1144 03 00960
9,7	133	87	5	1142 03 00970	1144 03 00970
9,8	133	87	5	1142 03 00980	1144 03 00980
9,9	133	87	5	1142 03 00990	1144 03 00990
10,0	133	87	5	1142 03 01000	1144 03 01000
10,2	133	87	5	1142 03 01020	1144 03 01020
10,5	133	87	5	1142 03 01050	1144 03 01050
11,0	142	94	5	1142 03 01100	1144 03 01100
11,5	142	94	5	1142 03 01150	1144 03 01150
12,0	151	101	5	1142 03 01200	1144 03 01200
12,5	151	101	5	1142 03 01250	1144 03 01250
13,0	151	101	5	1142 03 01300	1144 03 01300

* Nur solange Vorrat reicht / * Only as long as stock lasts

BC ABS-Boxen / BC ABS-Boxes

Bezeichnung Description	Teile Pieces	Inhalt Content	Artikel-Nr. Part-No.
KE 10 U-TL	19	Ø 1,0 – 10,0 mm x 0,5 mm	1142 14 30019
KE 13 U-TL	25	Ø 1,0 – 13,0 mm x 0,5 mm	1142 14 30025



KE 10 U-TL



KE 13 U-TL



SPIRALBOHRER
TWIST DRILLS

Spiralbohrer DIN 338 HSS-E (Co5) mit 3-Schneiden

Twist drills DIN 338 HSS-E (Co5) with 3 cutting edges



Code 1149



Code	P			M	K	N		S	
	1.1 - 2.1	3.1 - 4.1	5.1	1.1 - 2.1	1.1 - 4.2	1.1 - 1.6	2.1 - 2.6	4.2	1.1 - 2.6
1149	●	●	●	●	●	●	●	●	●

Industrie Spiralbohrer mit 3-Schneidengeometrie für bis zu 60% höheren Vorschub im Vergleich zu Bohrern mit 2 Schneiden. Bei Einsatz in CNC- oder NC-Maschinen Bohrungsqualitäten bis IT 9 möglich. Universell einsetzbar in Baustahl, unlegiertem und legiertem Stahl < 1.000 N/mm², sowie Aluminium (Knet- und Gusslegierungen).

Twist drill for industrial use with 3 cutting edges for up to 60% higher feed rate compared to twist drills with 2 cutting edges. Used in CNC machines drilling qualities up to IT 9 are possible. Universal use in structural steel, unalloyed and alloyed steel < 1,000 N/mm² (32,2 HRC), as well as aluminum (wrought and cast alloys).

Ø d mm	L 1 mm	L 2 mm		Artikel-Nr. Part-No.	
2,0	49	24	1	1149 03 00200	●
2,1	49	24	1	1149 03 00210	○
2,2	53	27	1	1149 03 00220	○
2,3	53	27	1	1149 03 00230	○
2,4	57	30	1	1149 03 00240	○
2,5	57	30	1	1149 03 00250	●
2,6	57	30	1	1149 03 00260	○
2,7	61	33	1	1149 03 00270	○
2,8	61	33	1	1149 03 00280	○
2,9	61	33	1	1149 03 00290	○
3,0	61	33	1	1149 03 00300	●
3,1	65	36	1	1149 03 00310	○
3,2	65	36	1	1149 03 00320	●
3,3	65	36	1	1149 03 00330	●
3,4	70	39	1	1149 03 00340	○
3,5	70	39	1	1149 03 00350	●
3,6	70	39	1	1149 03 00360	○
3,7	70	39	1	1149 03 00370	○
3,8	70	43	1	1149 03 00380	○
3,9	75	43	1	1149 03 00390	○
4,0	75	43	1	1149 03 00400	●
4,1	75	43	1	1149 03 00410	○
4,2	75	43	1	1149 03 00420	●
4,3	80	47	1	1149 03 00430	○
4,4	80	47	1	1149 03 00440	○
4,5	80	47	1	1149 03 00450	●
4,6	80	47	1	1149 03 00460	○
4,7	80	47	1	1149 03 00470	○
4,8	86	52	1	1149 03 00480	○
4,9	86	52	1	1149 03 00490	●
5,0	86	52	1	1149 03 00500	●
5,1	86	52	1	1149 03 00510	○
5,2	86	52	1	1149 03 00520	○
5,3	86	52	1	1149 03 00530	○
5,4	93	57	1	1149 03 00540	○
5,5	93	57	1	1149 03 00550	●
5,6	93	57	1	1149 03 00560	○
5,7	93	57	1	1149 03 00570	○
5,8	93	57	1	1149 03 00580	○
5,9	93	57	1	1149 03 00590	○
6,0	93	57	1	1149 03 00600	●
6,1	101	63	1	1149 03 00610	○
6,2	101	63	1	1149 03 00620	○
6,3	101	63	1	1149 03 00630	○
6,4	101	63	1	1149 03 00640	○
6,5	101	63	1	1149 03 00650	●
6,6	101	63	1	1149 03 00660	○
6,7	101	63	1	1149 03 00670	○
6,8	109	69	1	1149 03 00680	●

SPIRALBOHRER
TWIST DRILLS

Spiralbohrer DIN 338 HSS-E (Co5) mit 3-Schneiden Twist drills DIN 338 HSS-E (Co5) with 3 cutting edges



Code 1149

Ø d mm	L 1 mm	L 2 mm		Artikel-Nr. Part-No.	
6,9	109	69	1	1149 03 00690	○
7,0	109	69	1	1149 03 00700	●
7,1	109	69	1	1149 03 00710	○
7,2	109	69	1	1149 03 00720	○
7,3	109	69	1	1149 03 00730	○
7,4	109	69	1	1149 03 00740	○
7,5	109	69	1	1149 03 00750	●
7,6	117	75	1	1149 03 00760	○
7,7	117	75	1	1149 03 00770	○
7,8	117	75	1	1149 03 00780	○
7,9	117	75	1	1149 03 00790	○
8,0	117	75	1	1149 03 00800	●
8,1	117	75	1	1149 03 00810	○
8,2	117	75	1	1149 03 00820	○
8,3	117	75	1	1149 03 00830	○
8,4	117	75	1	1149 03 00840	○
8,5	117	75	1	1149 03 00850	●
8,6	125	81	1	1149 03 00860	○
8,7	125	81	1	1149 03 00870	○
8,8	125	81	1	1149 03 00880	○
8,9	125	81	1	1149 03 00890	○
9,0	125	81	1	1149 03 00900	●
9,1	125	81	1	1149 03 00910	○
9,2	125	81	1	1149 03 00920	○
9,3	125	81	1	1149 03 00930	○
9,4	125	81	1	1149 03 00940	○
9,5	125	81	1	1149 03 00950	●
9,6	133	87	1	1149 03 00960	○
9,7	133	87	1	1149 03 00970	○
9,8	133	87	1	1149 03 00980	○
9,9	133	87	1	1149 03 00990	○
10,0	133	87	1	1149 03 01000	●
10,2	133	87	1	1149 03 01020	●
10,5	133	87	1	1149 03 01050	●
11,0	142	94	1	1149 03 01100	●
11,5	142	94	1	1149 03 01150	●
12,0	151	101	1	1149 03 01200	●
12,5	151	101	1	1149 03 01250	●
13,0	151	101	1	1149 03 01300	●

● ab Lager / ex stock ○ Lieferzeit 10 – 14 Tage / Delivery time 10 – 14 days

BC ABS-Boxen / BC ABS-Boxes

Bezeichnung Description	Teile Pieces	Inhalt Content	Artikel-Nr. Part-No.	
KE 10 Z3	19	Ø 1,0 – 10,0 mm x 0,5 mm*	1149 13 30019	●
KE 24 Z3	24	Ø 1,0 – 10,5 mm x 0,5 mm* + Ø 3,3 · 4,2 · 6,8 · 10,2 mm	1149 13 30024	●
KE 13 Z3	25	Ø 1,0 – 13,0 mm x 0,5 mm*	1149 13 30025	●

* Ø 1,0 + 1,5 mm = Code 1147

BC Multi-Pack / BC Multi-Pack

Bezeichnung Description	Teile Pieces	Inhalt Content	Artikel-Nr. Part-No.	
ME 5 Z3	5	Ø 4 · 5 · 6 · 8 · 10 mm	1149 13 30005	●



Spiralbohrer DIN 338 HSS-E (Co8) Typ N-HD kobaltlegiert, Kreuzanschliff
 Twist drills DIN 338 HSS-E M42 (Co8) type N-HD cobalt alloyed, split point



Code 1147



Code 1148 TiALN



Code	P			M	K	N		S	H	
	1.1 - 2.1	3.1 - 4.1	5.1	1.1 - 2.1	1.1 - 4.2	1.1 - 1.6	2.1 - 2.6	4.2	1.1 - 1.3	1.1
1147	⊗	⊗	⊗	⊗	⊗	⊗	⊗	⊗	⊗	⊗
1148	⊗	⊗	⊗	⊗	⊗	⊗	⊗	⊗	⊗	⊗

Stabiler Spezialbohrer mit 8 % Kobaltlegierung. Hierdurch extrem ausgeprägte Warmhärtebeständigkeit. Für feste und hochfeste Werkstoffe bis 1.400 N/mm².

Heavy-Duty Ausführung!

Stable high performance twist drill with 8 % cobalt alloy, thereby high warm hardness durability. Suitable for materials with tensile strength up to 1.400 N/mm² (44 HRC).

Heavy-Duty Version!

Ø d mm	L 1 mm	L 2 mm	⊗	TiALN	
				Artikel-Nr. Part-No.	Artikel-Nr. Part-No.
1,0	34	12	10	1147 03 00100	-
1,1	36	14	10	1147 03 00110	-
1,2	38	16	10	1147 03 00120	-
1,3	38	16	10	1147 03 00130	-
1,4	40	18	10	1147 03 00140	-
1,5	40	18	10	1147 03 00150	-
1,6	43	20	10	1147 03 00160	-
1,7	43	20	10	1147 03 00170	-
1,8	46	23	10	1147 03 00180	-
1,9	46	23	10	1147 03 00190	-
2,0	49	24	10	1147 03 00200	1148 03 00200
2,1	49	24	10	1147 03 00210	1148 03 00210
2,2	53	27	10	1147 03 00220	1148 03 00220
2,3	53	27	10	1147 03 00230	1148 03 00230
2,4	57	30	10	1147 03 00240	1148 03 00240
2,5	57	30	10	1147 03 00250	1148 03 00250
2,6	57	30	10	1147 03 00260	1148 03 00260
2,8	61	33	10	1147 03 00280	1148 03 00280
2,9	61	33	10	1147 03 00290	1148 03 00290
3,0	61	33	10	1147 03 00300	1148 03 00300
3,1	65	36	10	1147 03 00310	1148 03 00310
3,2	65	36	10	1147 03 00320	1148 03 00320
3,3	65	36	10	1147 03 00330	1148 03 00330
3,4	70	39	10	1147 03 00340	1148 03 00340
3,5	70	39	10	1147 03 00350	1148 03 00350
3,6	70	39	10	1147 03 00360	1148 03 00360
3,7	70	39	10	1147 03 00370	1148 03 00370
3,8	70	43	10	1147 03 00380	1148 03 00380
3,9	75	43	10	1147 03 00390	1148 03 00390
4,0	75	43	10	1147 03 00400	1148 03 00400
4,1	75	43	10	1147 03 00410	1148 03 00410
4,2	75	43	10	1147 03 00420	1148 03 00420
4,3	80	47	10	1147 03 00430	1148 03 00430
4,4	80	47	10	1147 03 00440	1148 03 00440
4,5	80	47	10	1147 03 00450	1148 03 00450
4,6	80	47	10	1147 03 00460	1148 03 00460
4,7	80	47	10	1147 03 00470	1148 03 00470
4,8	86	52	10	1147 03 00480	1148 03 00480
4,9	86	52	10	1147 03 00490	1148 03 00490
5,0	86	52	10	1147 03 00500	1148 03 00500
5,1	86	52	10	1147 03 00510	1148 03 00510
5,2	86	52	10	1147 03 00520	1148 03 00520
5,3	86	52	10	1147 03 00530	1148 03 00530
5,4	93	57	10	1147 03 00540	1148 03 00540
5,5	93	57	10	1147 03 00550	1148 03 00550
5,6	93	57	10	1147 03 00560	1148 03 00560
5,7	93	57	10	1147 03 00570	1148 03 00570
5,8	93	57	10	1147 03 00580	1148 03 00580
5,9	93	57	10	1147 03 00590	1148 03 00590
6,0	93	57	10	1147 03 00600	1148 03 00600

SPIRALBOHRER
TWIST DRILLS

Spiralbohrer DIN 338 HSS-E (Co8) Typ N-HD kobaltlegiert, Kreuzanschliff
Twist drills DIN 338 HSS-E M42 (Co8) type N-HD cobalt alloyed, split point



Code 1147



Code 1148 TiALN

Ø d mm	L 1 mm	L 2 mm		TiALN	
				Artikel-Nr. Part-No.	Artikel-Nr. Part-No.
6,1	101	63	10	1147 03 00610	1148 03 00610
6,2	101	63	10	1147 03 00620	1148 03 00620
6,3	101	63	10	1147 03 00630	1148 03 00630
6,4	101	63	10	1147 03 00640	1148 03 00640
6,5	101	63	10	1147 03 00650	1148 03 00650
6,6	101	63	10	1147 03 00660	1148 03 00660
6,7	101	63	10	1147 03 00670	1148 03 00670
6,8	109	69	10	1147 03 00680	1148 03 00680
6,9	109	69	10	1147 03 00690	1148 03 00690
7,0	109	69	10	1147 03 00700	1148 03 00700
7,1	109	69	5	1147 03 00710	1148 03 00710
7,2	109	69	5	1147 03 00720	1148 03 00720
7,3	109	69	5	1147 03 00730	1148 03 00730
7,4	109	69	5	1147 03 00740	1148 03 00740
7,5	109	69	5	1147 03 00750	1148 03 00750
7,6	117	75	5	1147 03 00760	1148 03 00760
7,7	117	75	5	1147 03 00770	1148 03 00770
7,8	117	75	5	1147 03 00780	1148 03 00780
7,9	117	75	5	1147 03 00790	1148 03 00790
8,0	117	75	5	1147 03 00800	1148 03 00800
8,1	117	75	5	1147 03 00810	1148 03 00810
8,2	117	75	5	1147 03 00820	1148 03 00820
8,3	117	75	5	1147 03 00830	1148 03 00830
8,4	117	75	5	1147 03 00840	1148 03 00840
8,5	117	75	5	1147 03 00850	1148 03 00850
8,6	125	81	5	1147 03 00860	1148 03 00860
8,7	125	81	5	1147 03 00870	1148 03 00870
8,8	125	81	5	1147 03 00880	1148 03 00880
8,9	125	81	5	1147 03 00890	1148 03 00890
9,0	125	81	5	1147 03 00900	1148 03 00900
9,1	125	81	5	1147 03 00910	1148 03 00910
9,2	125	81	5	1147 03 00920	1148 03 00920
9,3	125	81	5	1147 03 00930	1148 03 00930
9,4	125	81	5	1147 03 00940	1148 03 00940
9,5	125	81	5	1147 03 00950	1148 03 00950
9,7	133	87	5	1147 03 00970	1148 03 00970
9,8	133	87	5	1147 03 00980	1148 03 00980
9,9	133	87	5	1147 03 00990	1148 03 00990
10,0	133	87	5	1147 03 01000	1148 03 01000
10,2	133	87	5	1147 03 01020	1148 03 01020
10,5	133	87	5	1147 03 01050	1148 03 01050
10,8	142	94	5	1147 03 01080	1148 03 01080
11,0	142	94	5	1147 03 01100	1148 03 01100
11,5	142	94	5	1147 03 01150	1148 03 01150
12,0	151	101	5	1147 03 01200	1148 03 01200
12,5	151	101	5	1147 03 01250	1148 03 01250
13,0	151	101	5	1147 03 01300	1148 03 01300

BC ABS-Boxen / BC ABS-Boxes

Bezeichnung Description	Teile Pieces	Inhalt Content	Artikel-Nr. Part-No.
KE 10 Co8	19	Ø 1,0 – 10,0 mm x 0,5 mm	1147 14 30019
KE 13 Co8	25	Ø 1,0 – 13,0 mm x 0,5 mm	1147 14 30025



Spiralbohrer für **HARDOX HSS-E (Co8) Typ HDX kobaltlegiert**
Twist drills for **HARDOX HSS-E M42 (Co8) type HDX cobalt alloyed**



- Stabiler Spezialanschliff
- Stable point angle



- Extra kurze Spirale, dadurch sehr stabil
- Verstärkter Kern
- Extra short flute for higher stability
- Reinforced web thickness



- ZRN+ Beschichtung für hohe Standzeit
- ZRN+ coating for longer tool life

Ideal zur Bearbeitung von Baggerlöffeln, Radladerschaufeln, Muldenkipper, Schüttelrutschen, etc. aus verschleißfesten Blechen.

Ideal for machining excavator buckets, wheel loader shovels, dumpers, vibrating chutes etc. made of wear-resistant sheet metals.



Spiralbohrer für **HARDOX HSS-E (Co8) Typ HDX kobaltlegiert**
Twist drills for **HARDOX HSS-E M42 (Co8) type HDX cobalt alloyed**

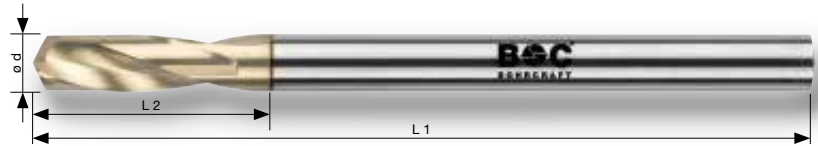

Code 1508



Code	P			M	K	N			S	H
	1.1 - 2.1	3.1 - 4.1	5.1	1.1 - 2.1	1.1 - 4.2	1.1 - 1.6	2.1 - 2.6	4.2	1.1 - 1.3	1.1
1508										

- Stabiler Spezialbohrer mit extrem ausgeprägter Warmhärtebeständigkeit. Für verschleißfeste Bleche, XAR, HARDOX 400 / 450 / 500 / HiTuf.
- Hohe Standzeit durch M42/Co8-Stahl und spezielle ZRN+ Beschichtung mit niedrigem Reibwert!
- Stable High Performance twist drill with high warm hardness durability. For wear-resistant sheet metal, XAR, HARDOX 400 / 450 / 500 / HiTuf.
- Long tool life due to M42/Co8 steel and special ZRN+ coating with a low coefficient of friction!

Ø d mm	L 1 mm	L 2 mm		Artikel-Nr. Part-No.
1,0	34	6	1	1508 03 00100
1,5	40	9	1	1508 03 00150
2,0	49	12	1	1508 03 00200
2,5	57	14	1	1508 03 00250
3,0	61	16	1	1508 03 00300
3,2	65	18	1	1508 03 00320
3,3	65	18	1	1508 03 00330
3,5	70	20	1	1508 03 00350
4,0	75	22	1	1508 03 00400
4,2	75	22	1	1508 03 00420
4,5	80	24	1	1508 03 00450
5,0	86	26	1	1508 03 00500
5,5	93	28	1	1508 03 00550
6,0	93	28	1	1508 03 00600
6,5	101	31	1	1508 03 00650
6,8	109	34	1	1508 03 00680
7,0	109	34	1	1508 03 00700
7,5	109	34	1	1508 03 00750
8,0	117	37	1	1508 03 00800
8,5	117	37	1	1508 03 00850
9,0	125	40	1	1508 03 00900
9,5	125	40	1	1508 03 00950
10,0	133	43	1	1508 03 01000
10,2	133	43	1	1508 03 01020
10,5	133	43	1	1508 03 01050
11,0	142	47	1	1508 03 01100
11,5	142	47	1	1508 03 01150
12,0	151	51	1	1508 03 01200
12,5	151	51	1	1508 03 01250
13,0	151	51	1	1508 03 01300

BC ABS-Boxen / BC ABS-Boxes

Bezeichnung Description	Teile Pieces	Inhalt Content	Artikel-Nr. Part-No.
KE 10 HDX	19	Ø 1,0 – 10,0 mm x 0,5 mm	1508 13 30019
KE 24 HDX	24	Ø 1,0 – 10,5 mm x 0,5 mm + Ø 3,3 · 4,2 · 6,8 · 10,2 mm	1508 13 30024
KE 13 HDX	25	Ø 1,0 – 13,0 mm x 0,5 mm	1508 13 30025



BC Multi-Pack / BC Multi-Pack

Bezeichnung Description	Teile Pieces	Inhalt Content	Artikel-Nr. Part-No.
ME 5 HDX	5	Ø 4 · 5 · 6 · 8 · 10 mm	1508 13 30005



SPIRALBOHRER TWIST DRILLS

Spiralbohrer DIN 340 HSS rollgewalzt

Twist drills DIN 340 HSS roll forged

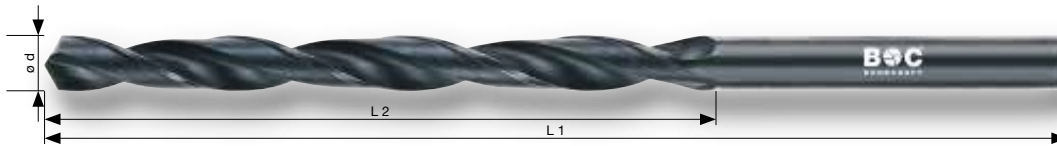

Code 1340



Code	P			M	K	N		S
	1.1 - 2.1	3.1 - 4.1	5.1	1.1 - 4.1	1.1 - 4.2	1.1 - 1.6	2.1 - 2.6	4.2
1340	⊗					⊗	⊗	⊗

Spanlos hergestellter Spiralbohrer, dadurch erhöhte Elastizität und Bruchsicherheit. Geeignet für robuste Bohrarbeiten in normalharten Werkstoffen sowie NE-Metallen.

Twist drill made in a metal forging process, thereby increasing of elasticity and breakage resistance. Suitable for robust drilling work in normal materials and non-ferrous metals.

Ø d mm	L 1 mm	L 2 mm		Artikel-Nr. Part-No.
2,0	85	56	10	1340 01 00200
2,5	95	62	10	1340 01 00250
2,8	100	66	10	1340 01 00280
3,0	100	66	10	1340 01 00300
3,2	106	69	10	1340 01 00320
3,3	106	69	10	1340 01 00330
3,4	112	73	10	1340 01 00340
3,5	112	73	10	1340 01 00350
3,7	112	73	10	1340 01 00370
3,8	119	78	10	1340 01 00380
3,9	119	78	10	1340 01 00390
4,0	119	78	10	1340 01 00400
4,1	119	78	10	1340 01 00410
4,2	119	78	10	1340 01 00420
4,4	126	82	10	1340 01 00440
4,5	126	82	10	1340 01 00450
4,8	132	87	10	1340 01 00480
4,9	132	87	10	1340 01 00490
5,0	132	87	10	1340 01 00500
5,1	132	87	10	1340 01 00510
5,2	132	87	10	1340 01 00520
5,5	139	91	10	1340 01 00550
5,8	139	91	10	1340 01 00580
6,0	139	91	10	1340 01 00600
6,2	148	97	10	1340 01 00620
6,3	148	97	10	1340 01 00630
6,5	148	97	10	1340 01 00650
6,8	156	102	10	1340 01 00680
7,0	156	102	10	1340 01 00700
7,5	156	102	10	1340 01 00750
8,0	165	109	10	1340 01 00800
8,5	165	109	10	1340 01 00850
9,0	175	115	10	1340 01 00900
9,5	175	115	10	1340 01 00950
10,0	184	121	10	1340 01 01000
10,5	184	121	5	1340 01 01050
11,0	195	128	5	1340 01 01100
11,5	195	128	5	1340 01 01150
12,0	205	134	5	1340 01 01200
12,5	205	134	5	1340 01 01250
13,0	205	134	5	1340 01 01300

Spiralbohrer DIN 340 HSS-G geschliffen, Kreuzanschiff Twist drills DIN 340 HSS-G fully ground, split point



Code 1350



Code	P			M	K	N		S
	1.1 - 2.1	3.1 - 4.1	5.1	1.1 - 4.1	1.1 - 4.2	1.1 - 1.6	2.1 - 2.6	4.2
1350	☉				☉	☉	☉	☉

Spiralbohrer für normalharte Werkstoffe wie allgemeine Bau-
stähle, NE-Metalle und Gusseisen.

Twist drill for materials with normal tensile strength, e.g. in
general structural steels, non ferrous materials and cast iron.

Ø d1 mm	L 1 mm	L 2 mm		Artikel-Nr. Part-No.		Artikel-Nr. Part-No.
1,0	56	33	10	1350 01 00100	-	-
1,5	70	45	10	1350 01 00150	-	-
2,0	85	56	10	1350 01 00200	2	1350 07 20200
2,5	95	62	10	1350 01 00250	2	1350 07 20250
2,8	100	66	10	1350 01 00280	-	-
3,0	100	66	10	1350 01 00300	2	1350 07 20300
3,1	106	69	10	1350 01 00310	-	-
3,2	106	69	10	1350 01 00320	2	1350 07 20320
3,3	106	69	10	1350 01 00330	-	-
3,5	112	73	10	1350 01 00350	2	1350 07 20350
3,6	112	73	10	1350 01 00360	-	-
3,7	112	73	10	1350 01 00370	-	-
3,8	119	78	10	1350 01 00380	-	-
3,9	119	78	10	1350 01 00390	-	-
4,0	119	78	10	1350 01 00400	2	1350 07 20400
4,1	119	78	10	1350 01 00410	-	-
4,2	119	78	10	1350 01 00420	-	-
4,3	126	82	10	1350 01 00430	-	-
4,4	126	82	10	1350 01 00440	-	-
4,5	126	82	10	1350 01 00450	1	1350 07 00450
4,8	132	87	10	1350 01 00480	-	-
4,9	132	87	10	1350 01 00490	-	-
5,0	132	87	10	1350 01 00500	1	1350 07 00500
5,1	132	87	10	1350 01 00510	-	-
5,2	132	87	10	1350 01 00520	-	-
5,3	132	87	10	1350 01 00530	-	-
5,4	139	91	10	1350 01 00540	-	-
5,5	139	91	10	1350 01 00550	1	1350 07 00550
5,8	139	91	10	1350 01 00580	-	-
6,0	139	91	10	1350 01 00600	1	1350 07 00600
6,2	148	97	10	1350 01 00620	-	-
6,5	148	97	10	1350 01 00650	1	1350 07 00650
6,8	156	102	10	1350 01 00680	-	-
7,0	156	102	10	1350 01 00700	1	1350 07 00700
7,5	156	102	10	1350 01 00750	1	1350 07 00750
7,7*	165	109	10	1350 01 00770	-	-
8,0	165	109	10	1350 01 00800	1	1350 07 00800
8,5	165	109	10	1350 01 00850	1	1350 07 00850
9,0	175	115	10	1350 01 00900	1	1350 07 00900
9,5	175	115	10	1350 01 00950	1	1350 07 00950
9,8*	184	121	10	1350 01 00980	-	-
10,0	184	121	10	1350 01 01000	1	1350 07 01000
10,2	184	121	5	1350 01 01020	-	-
10,5	184	121	5	1350 01 01050	-	-
11,0	195	128	5	1350 01 01100	1	1350 07 01100
11,5	195	128	5	1350 01 01150	-	-
12,0	205	134	5	1350 01 01200	1	1350 07 01200
12,5	205	134	5	1350 01 01250	-	-
13,0	205	134	5	1350 01 01300	1	1350 07 01300
14,0	214	140	1	1350 02 01400	-	-
16,0	227	149	1	1350 02 01600	-	-

* Nur solange Vorrat reicht / * Only as long as stock lasts



SPIRALBOHRER
TWIST DRILLS

Spiralbohrer DIN 340 HSS-G Typ N geschliffen, Kreuzanschlift

Twist drills DIN 340 HSS-G type N fully ground, split point

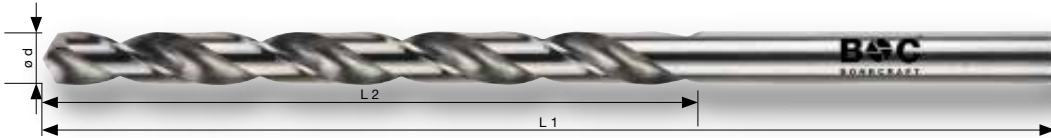

Code 1353



Code	P			M	K	N		S
	1.1 - 2.1	3.1 - 4.1	5.1	1.1 - 4.1	1.1 - 4.2	1.1 - 1.6	2.1 - 2.6	4.2
1353	⊗	⊗			⊗	⊗	⊗	⊗

Premium Spiralbohrer für normalharte Werkstoffe wie allgemeine Baustähle, NE-Metalle und Gusseisen.

Premium twist drill for materials with normal tensile strength, e.g. in general structural steels, non ferrous materials and cast iron.

Ø d mm	L 1 mm	L 2 mm		Artikel-Nr. Part-No.
0,7	42	21	10	1353 03 00070
0,8	46	25	10	1353 03 00080
0,9	51	29	10	1353 03 00090
1,0	56	33	10	1353 03 00100
1,5	70	45	10	1353 03 00150
2,0	85	56	10	1353 03 00200
2,5	95	62	10	1353 03 00250
2,8	100	66	10	1353 03 00280
3,0	100	66	10	1353 03 00300
3,2	106	69	10	1353 03 00320
3,3	106	69	10	1353 03 00330
3,4	112	73	10	1353 03 00340
3,5	112	73	10	1353 03 00350
3,6	112	73	10	1353 03 00360
3,8	119	78	10	1353 03 00380
3,9	119	78	10	1353 03 00390
4,0	119	78	10	1353 03 00400
4,1	119	78	10	1353 03 00410
4,2	119	78	10	1353 03 00420
4,3	126	82	10	1353 03 00430
4,4	126	82	10	1353 03 00440
4,5	126	82	10	1353 03 00450
4,6	126	82	10	1353 03 00460
4,7	126	82	10	1353 03 00470
4,8	132	87	10	1353 03 00480
5,0	132	87	10	1353 03 00500
5,1	132	87	10	1353 03 00510
5,2	132	87	10	1353 03 00520
5,4	139	91	10	1353 03 00540
5,5	139	91	10	1353 03 00550
5,7	139	91	10	1353 03 00570
5,8	139	91	10	1353 03 00580
6,0	139	91	10	1353 03 00600
6,1	148	97	5	1353 03 00610
6,2	148	97	5	1353 03 00620
6,3	148	97	5	1353 03 00630
6,4	148	97	5	1353 03 00640
6,5	148	97	5	1353 03 00650
6,8	156	102	5	1353 03 00680
7,0	156	102	5	1353 03 00700
7,5	156	102	5	1353 03 00750
8,0	165	109	5	1353 03 00800
8,5	165	109	5	1353 03 00850
9,0	175	115	5	1353 03 00900
9,5	175	115	5	1353 03 00950
10,0	184	121	5	1353 03 01000
10,2	184	121	1	1353 03 01020
10,5	184	121	1	1353 03 01050
11,0	195	128	1	1353 03 01100
11,5	195	128	1	1353 03 01150
12,0	205	134	1	1353 03 01200
12,5	205	134	1	1353 03 01250
13,0	205	134	1	1353 03 01300

SPIRALBOHRER
TWIST DRILLS

Spiralbohrer DIN 340 HSS-E (Co5) Typ N kobaltlegiert, Kreuzanschliff
Twist drills DIN 340 HSS-E (Co5) type N cobalt alloyed, split point



Code 1360



Code 1361 TiN



Code	P			M	K	N			S
	1.1 - 2.1	3.1 - 4.1	5.1	1.1 - 2.1	1.1 - 4.2	1.1 - 1.6	2.1 - 2.6	4.2	1.1 - 2.6
1360	⊗	⊗	⊗	⊗		⊗	⊗		⊗
1361	⊗	⊗	⊗	⊗			⊗		⊗

Premium Spiralbohrer mit höherer Warmhärtebeständigkeit, zum Bohren von rost-, säure- und hitzebeständigen Stählen.

Premium twist drill with higher heat resistance, for drilling stainless steels and heat resistant steels.

Ø d mm	L 1 mm	L 2 mm	📦	TiN	
				Artikel-Nr. Part-No.	Artikel-Nr. Part-No.
2,0	85	56	10	1360 03 00200	1361 03 00200
2,5	95	62	10	1360 03 00250	1361 03 00250
3,0	100	66	10	1360 03 00300	1361 03 00300
3,1	106	69	10	1360 03 00310	1361 03 00310
3,2	106	69	10	1360 03 00320	1361 03 00320
3,3	106	69	10	1360 03 00330	1361 03 00330
3,5	112	73	10	1360 03 00350	1361 03 00350
3,8	119	78	10	1360 03 00380	1361 03 00380
4,0	119	78	10	1360 03 00400	1361 03 00400
4,1	119	78	10	1360 03 00410	1361 03 00410
4,2	119	78	10	1360 03 00420	1361 03 00420
4,5	126	82	10	1360 03 00450	1361 03 00450
5,0	132	87	10	1360 03 00500	1361 03 00500
5,2	132	87	10	1360 03 00520	1361 03 00520
5,5	139	91	10	1360 03 00550	1361 03 00550
6,0	139	91	10	1360 03 00600	1361 03 00600
6,5	148	97	5	1360 03 00650	1361 03 00650
6,8	156	102	5	1360 03 00680	1361 03 00680
7,0	156	102	5	1360 03 00700	1361 03 00700
7,5	156	102	5	1360 03 00750	1361 03 00750
8,0	165	109	5	1360 03 00800	1361 03 00800
8,5	165	109	5	1360 03 00850	1361 03 00850
9,0	175	115	5	1360 03 00900	1361 03 00900
9,5	175	115	5	1360 03 00950	1361 03 00950
10,0	184	121	5	1360 03 01000	1361 03 01000
10,5	184	121	1	1360 03 01050	1361 03 01050
11,0	195	128	1	1360 03 01100	1361 03 01100
11,5	195	128	1	1360 03 01150	1361 03 01150
12,0	205	134	1	1360 03 01200	1361 03 01200
12,5	205	134	1	1360 03 01250	1361 03 01250
13,0	205	134	1	1360 03 01300	1361 03 01300



SPIRALBOHRER
TWIST DRILLS

Mehrbereichsbohrer DIN 340 HSS-E (Co5) Typ U-TL kobaltlegiert, Kreuzanschliff

Multigrade drills DIN 340 HSS-E (Co5) type U-TL cobalt alloyed, split point

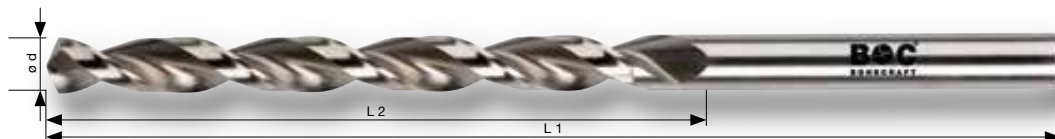

Code 1362



Code	P			M	K	N		S
	1.1 - 2.1	3.1 - 4.1	5.1	1.1 - 2.1	1.1 - 4.2	1.1 - 1.6	2.1 - 2.6	4.2
1362								

Mehrbereichsbohrer mit parabolisch geformter Spannanz zur besseren Spanabfuhr. Für Werkstoffe mit einer Festigkeit bis 1.200 N/mm².

Ideal zum Bohren von mittel-, langspanenden und schwer zerspanbaren Werkstoffen. Deckt in weiten Bereichen Typ N, H und W ab!

Multigrade twist drill with parabolic flute for improved chip removal. Suitable for materials with tensile strength up to 1.200 N/mm² (38 HRC).

Especially suitable for medium, long chipping and hard machinable materials. Covers drill-sectors which should be drilled with Type N, H and W drills!

Ø d mm	L 1 mm	L 2 mm		Artikel-Nr. Part-No.
2,0	85	56	10	1362 03 00200
2,5	95	62	10	1362 03 00250
3,0	100	66	10	1362 03 00300
3,5	112	73	10	1362 03 00350
4,0	119	78	10	1362 03 00400
4,2	119	78	10	1362 03 00420
4,5	126	82	10	1362 03 00450
5,0	132	87	10	1362 03 00500
5,2	132	87	10	1362 03 00520
5,5	139	91	10	1362 03 00550
6,0	139	91	10	1362 03 00600
6,5	148	97	5	1362 03 00650
7,0	156	102	5	1362 03 00700
7,5	156	102	5	1362 03 00750
8,0	165	109	5	1362 03 00800
8,5	165	109	5	1362 03 00850
9,0	175	115	5	1362 03 00900
9,5	175	115	5	1362 03 00950
10,0	184	121	5	1362 03 01000
10,5	184	121	1	1362 03 01050
11,0	195	128	1	1362 03 01100
11,5	195	128	1	1362 03 01150
12,0	205	134	1	1362 03 01200
12,5	205	134	1	1362 03 01250
13,0	205	134	1	1362 03 01300

 SPIRALBOHRER
TWIST DRILLS

Spiralbohrer DIN 1869 HSS-G Typ N geschliffen, Kreuzanschliff
Twist drills DIN 1869 HSS-G type N fully ground, split point



Code 1400



Code	P			M	K	N		S
	1.1 - 2.1	3.1 - 4.1	5.1	1.1 - 4.1	1.1 - 4.2	1.1 - 1.6	2.1 - 2.6	4.2
1400								

Zum Bohren extrem tiefer Löcher in Stahl/Metall. Auf ausreichende Kühlung und häufige Spanentleerung achten. Vorschub und Schnittgeschwindigkeit der Stabilität des Bohrers anpassen.

For drilling very deep holes in steel/metal. When drilling please care for sufficient cooling. Cutting-speed and drill-feed must be in relation to stability of drill.

Ø d mm	L 1 mm	L 2 mm		Artikel-Nr. Part-No.
Reihe 1 / Series 1				
2,0	125	85	1	1400 07 10200
2,5	140	85	1	1400 07 10250
3,0	150	100	1	1400 07 10300
3,2	155	105	1	1400 07 10320
3,3	155	105	1	1400 07 10330
3,5	165	115	1	1400 07 10350
4,0	175	120	1	1400 07 10400
4,2	175	120	1	1400 07 10420
4,5	185	125	1	1400 07 10450
5,0	195	135	1	1400 07 10500
5,5	205	140	1	1400 07 10550
6,0	205	140	1	1400 07 10600
6,1*	215	150	1	1400 07 10610
6,5	215	150	1	1400 07 10650
7,0	225	155	1	1400 07 10700
7,5	225	155	1	1400 07 10750
8,0	240	165	1	1400 07 10800
8,5	240	165	1	1400 07 10850
9,0	250	175	1	1400 07 10900
9,5	250	175	1	1400 07 10950
10,0	265	185	1	1400 07 11000
10,5	265	185	1	1400 07 11050
11,0	280	195	1	1400 07 11100
11,5	280	195	1	1400 07 11150
12,0	295	205	1	1400 07 11200
12,5	295	205	1	1400 07 11250
13,0	295	205	1	1400 07 11300
Reihe 2 / Series 2				
3,0	190	130	1	1400 07 20300
3,2	200	135	1	1400 07 20320
3,5	210	145	1	1400 07 20350
3,8*	220	150	1	1400 07 20380
4,0	220	150	1	1400 07 20400
4,5	235	160	1	1400 07 20450
5,0	245	170	1	1400 07 20500
5,1*	245	170	1	1400 07 20510
5,5	260	180	1	1400 07 20550

Ø d mm	L 1 mm	L 2 mm		Artikel-Nr. Part-No.
6,0	260	180	1	1400 07 20600
6,5	275	190	1	1400 07 20650
7,0	290	200	1	1400 07 20700
7,5	290	200	1	1400 07 20750
8,0	305	210	1	1400 07 20800
8,5	305	210	1	1400 07 20850
9,0	320	220	1	1400 07 20900
9,5	320	220	1	1400 07 20950
10,0	340	235	1	1400 07 21000
10,5	340	235	1	1400 07 21050
11,0	365	250	1	1400 07 21100
11,5	365	250	1	1400 07 21150
12,0	375	260	1	1400 07 21200
12,5	375	260	1	1400 07 21250
13,0	375	260	1	1400 07 21300
Reihe 3 / Series 3				
3,5	265	180	1	1400 07 30350
3,8*	280	190	1	1400 07 30380
4,0	280	190	1	1400 07 30400
4,2	280	190	1	1400 07 30420
4,5	295	200	1	1400 07 30450
5,0	315	210	1	1400 07 30500
5,5	330	225	1	1400 07 30550
6,0	330	225	1	1400 07 30600
6,5	350	235	1	1400 07 30650
7,0	370	250	1	1400 07 30700
7,5	370	250	1	1400 07 30750
8,0	390	265	1	1400 07 30800
8,5	390	265	1	1400 07 30850
9,0	410	280	1	1400 07 30900
10,0	430	295	1	1400 07 31000
10,5	430	295	1	1400 07 31050
11,0	455	310	1	1400 07 31100
11,5	455	310	1	1400 07 31150
12,0	480	330	1	1400 07 31200
12,5	480	330	1	1400 07 31250
13,0	480	330	1	1400 07 31300

* Nur solange Vorrat reicht / * Only as long as stock lasts



SPIRALBOHRER
TWIST DRILLS

Mehrbereichsbohrer DIN 1869 HSS-G Typ U-TL geschliffen, Kreuzanschliiff

Multigrade drills DIN 1869 HSS-G type U-TL fully ground, split point



Code 1410



Code	P			M	K	N			S
	1.1 - 2.1	3.1 - 4.1	5.1	1.1 - 4.1	1.1 - 4.2	1.1 - 1.6	2.1 - 2.6	4.2	1.1 - 2.6
1410	⊗	⊗			⊗	⊗	⊗	⊗	

Mehrbereichsbohrer mit verstärktem Bohrerker und parabolisch geformter Spannutt zur besseren Spanabfuhr. Für Stahl und Stahlguss legiert und unlegiert, Grau- und Tempereguss, Sphäro- und Druckguss, Sintereisen, Graphit, kurzspannende Aluminiumlegierungen, Messing und Bronze. **Ideal zum Bohren von mittel- und langspannenden Werkstoffen!**

Multigrade twist drill with reinforced web and parabolic flute for better chip flow. For steel and cast steel alloyed and unalloyed, cast iron, annealed cast iron, ductile graphite iron, diecast, short-chipping aluminium-alloys, brass and bronze.

Especially suitable for medium and long chipping materials!

Ø d mm	L 1 mm	L 2 mm		Artikel-Nr. Part-No.
Reihe 1 / Series 1				
2,0	125	85	1	1410 07 10200
2,5	140	95	1	1410 07 10250
3,0	150	100	1	1410 07 10300
3,2	155	105	1	1410 07 10320
3,3	155	105	1	1410 07 10330
3,5	165	115	1	1410 07 10350
4,0	175	120	1	1410 07 10400
4,2	175	120	1	1410 07 10420
4,5	185	125	1	1410 07 10450
5,0	195	135	1	1410 07 10500
5,5	205	140	1	1410 07 10550
6,0	205	140	1	1410 07 10600
6,5	215	150	1	1410 07 10650
7,0	225	155	1	1410 07 10700
7,5	225	155	1	1410 07 10750
8,0	240	165	1	1410 07 10800
8,5	240	165	1	1410 07 10850
9,0	250	175	1	1410 07 10900
9,5	250	175	1	1410 07 10950
10,0	265	185	1	1410 07 11000
10,5	265	185	1	1410 07 11050
11,0	280	195	1	1410 07 11100
11,5	280	195	1	1410 07 11150
12,0	295	205	1	1410 07 11200
12,5	295	205	1	1410 07 11250
13,0	295	205	1	1410 07 11300
Reihe 2 / Series 2				
3,0	190	130	1	1410 07 20300
3,2	200	135	1	1410 07 20320
3,5	210	145	1	1410 07 20350
4,0	220	150	1	1410 07 20400
4,2	220	150	1	1410 07 20420
4,5	235	160	1	1410 07 20450
5,0	245	170	1	1410 07 20500
5,5	260	180	1	1410 07 20550
6,0	260	180	1	1410 07 20600

Ø d mm	L 1 mm	L 2 mm		Artikel-Nr. Part-No.
6,5	275	190	1	1410 07 20650
7,0	290	200	1	1410 07 20700
7,5	290	200	1	1410 07 20750
8,0	305	210	1	1410 07 20800
8,5	305	210	1	1410 07 20850
9,0	320	220	1	1410 07 20900
9,5	320	220	1	1410 07 20950
10,0	340	235	1	1410 07 21000
10,5	340	235	1	1410 07 21050
11,0	365	250	1	1410 07 21100
11,5	365	250	1	1410 07 21150
12,0	375	260	1	1410 07 21200
12,5	375	260	1	1410 07 21250
13,0	375	260	1	1410 07 21300
Reihe 3 / Series 3				
3,5	265	180	1	1410 07 30350
4,0	280	190	1	1410 07 30400
4,2	280	190	1	1410 07 30420
4,5	295	200	1	1410 07 30450
5,0	315	210	1	1410 07 30500
5,5	330	225	1	1410 07 30550
6,0	330	225	1	1410 07 30600
6,5	350	235	1	1410 07 30650
7,0	370	250	1	1410 07 30700
7,5	370	250	1	1410 07 30750
8,0	390	265	1	1410 07 30800
8,5	390	265	1	1410 07 30850
9,0	410	280	1	1410 07 30900
9,5	410	280	1	1410 07 30950
10,0	430	295	1	1410 07 31000
10,5	430	295	1	1410 07 31050
11,0	455	310	1	1410 07 31100
11,5	455	310	1	1410 07 31150
12,0	480	330	1	1410 07 31200
12,5	480	330	1	1410 07 31250
13,0	480	330	1	1410 07 31300

SPIRALBOHRER
TWIST DRILLS

Mehrbereichsbohrer DIN 1869 HSS-E (Co5) Typ U-TL kobaltlegiert, Kreuzanschliff
Multigrade drills DIN 1869 HSS-E (Co5) type U-TL cobalt alloyed, split point



Code 1420

DIN 1869
HSS-E Co5
Typ U-TL
TIEFLOCH DEEPHOLE Version
VA INOX
130°
SPLIT POINT
>10xD

Code	P			M	K	N		S
	1.1 - 2.1	3.1 - 4.1	5.1	1.1 - 2.1	1.1 - 4.2	1.1 - 1.6	2.1 - 2.6	4.2
1420								

Mehrbereichsbohrer mit verstärktem Bohrerker und parabolisch geformter Spannurt zur besseren Spanabfuhr. Für Werkstoffe mit einer Festigkeit bis 1.200 N/mm².

Ideal zum Bohren von mittel-, langspannenden und schwer zerspanbaren Werkstoffen. Deckt in weiten Bereichen Typ N, H und W ab!

Multigrade twist drill with reinforced web and parabolic flute for improved chip removal. Suitable for materials with tensile strength up to 1.200 N/mm² (38 HRC).

Especially suitable for medium, long chipping and hard machinable materials. Covers drill-sectors which should be drilled with Type N, H and W drills!

Ø d mm	L 1 mm	L 2 mm		Artikel-Nr. Part-No.
Reihe 1 / Series 1				
2,0	125	85	1	1420 07 10200
2,5	140	85	1	1420 07 10250
3,0	150	100	1	1420 07 10300
3,2	155	105	1	1420 07 10320
3,3	155	105	1	1420 07 10330
3,5	165	115	1	1420 07 10350
4,0	175	120	1	1420 07 10400
4,2	175	120	1	1420 07 10420
4,5	185	125	1	1420 07 10450
5,0	195	135	1	1420 07 10500
5,5	205	140	1	1420 07 10550
6,0	205	140	1	1420 07 10600
6,5	215	150	1	1420 07 10650
7,0	225	155	1	1420 07 10700
7,5	225	155	1	1420 07 10750
8,0	240	165	1	1420 07 10800
8,5	240	165	1	1420 07 10850
9,0	250	175	1	1420 07 10900
9,5	250	175	1	1420 07 10950
10,0	265	185	1	1420 07 11000
10,5	265	185	1	1420 07 11050
11,0	280	195	1	1420 07 11100
11,5	280	195	1	1420 07 11150
12,0	295	205	1	1420 07 11200
12,5	295	205	1	1420 07 11250
13,0	295	205	1	1420 07 11300
Reihe 2 / Series 2				
3,0	190	130	1	1420 07 20300
3,2	200	135	1	1420 07 20320
3,5	210	145	1	1420 07 20350
4,0	220	150	1	1420 07 20400
4,2	220	150	1	1420 07 20420
4,5	235	160	1	1420 07 20450
5,0	245	170	1	1420 07 20500
5,5	260	180	1	1420 07 20550
6,0	260	180	1	1420 07 20600

Ø d mm	L 1 mm	L 2 mm		Artikel-Nr. Part-No.
6,5	275	190	1	1420 07 20650
7,0	290	200	1	1420 07 20700
7,5	290	200	1	1420 07 20750
8,0	305	210	1	1420 07 20800
8,5	305	210	1	1420 07 20850
9,0	320	220	1	1420 07 20900
9,5	320	220	1	1420 07 20950
10,0	340	235	1	1420 07 21000
10,5	340	235	1	1420 07 21050
11,0	365	250	1	1420 07 21100
11,5	365	250	1	1420 07 21150
12,0	375	260	1	1420 07 21200
12,5	375	260	1	1420 07 21250
13,0	375	260	1	1420 07 21300
Reihe 3 / Series 3				
3,5	265	180	1	1420 07 30350
4,0	280	190	1	1420 07 30400
4,2	280	190	1	1420 07 30420
4,5	295	200	1	1420 07 30450
5,0	315	210	1	1420 07 30500
5,5	330	225	1	1420 07 30550
6,0	330	225	1	1420 07 30600
6,5	350	235	1	1420 07 30650
7,0	370	250	1	1420 07 30700
7,5	370	250	1	1420 07 30750
8,0	390	265	1	1420 07 30800
8,5	390	265	1	1420 07 30850
9,0	410	280	1	1420 07 30900
9,5	410	280	1	1420 07 30950
10,0	430	295	1	1420 07 31000
10,5	430	295	1	1420 07 31050
11,0	455	310	1	1420 07 31100
11,5	455	310	1	1420 07 31150
12,0	480	330	1	1420 07 31200
12,5	480	330	1	1420 07 31250
13,0	480	330	1	1420 07 31300



SPIRALBOHRER
TWIST DRILLS

Hohlprofil- / Dachdeckerbohrer HSS-G geschliffen, Kreuzanschliiff
Twist drills for hollow profiles HSS-G fully ground, split point

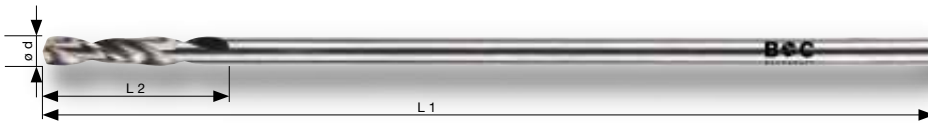

Code 1440



Code	P			M	K	N		S
	1.1 - 2.1	3.1 - 4.1	5.1	1.1 - 4.1	1.1 - 4.2	1.1 - 1.6	2.1 - 2.6	4.2
1440	⊗					⊗		⊗

Spezialbohrer für die Bearbeitung und Anbringung von Hohlprofilen z. B. im Fensterbau.

Special twist drill designed for working on hollow profiles.

Ø d mm	L 1 mm	L 2 mm		Artikel-Nr. Part-No.
2,5	100	30	10	1440 03 25100
3,0	100	30	10	1440 03 30100
3,2	100	30	10	1440 03 32100
3,5	100	30	10	1440 03 35100
4,0	100	30	10	1440 03 40100
4,2	100	30	10	1440 03 42100
4,9	100	30	10	1440 03 49100
4,9	150	30	10	1440 03 49150
5,0	70	30	10	1440 03 50070
5,0	100	30	10	1440 03 50100
5,0	150	30	10	1440 03 50150
5,0	210	30	10	1440 03 50210
5,1	100	30	10	1440 03 51100
5,1	150	30	10	1440 03 51150
5,1	210	30	10	1440 03 51210
5,3	100	30	10	1440 03 53100
5,3	150	30	10	1440 03 53150
5,3	210	30	10	1440 03 53210
5,5	100	30	10	1440 03 55100
5,5	150	30	10	1440 03 55150
5,5	210	30	10	1440 03 55210
5,7	70	30	10	1440 03 57070
5,7	100	30	10	1440 03 57100
5,7	150	30	10	1440 03 57150
5,7	210	30	10	1440 03 57210
5,8	100	30	10	1440 03 58100
5,8	150	30	10	1440 03 58150
5,8	210	30	10	1440 03 58210
5,9	100	30	10	1440 03 59100
5,9	150	30	10	1440 03 59150
5,9	210	30	10	1440 03 59210
6,0	100	30	10	1440 03 60100
6,0	150	30	10	1440 03 60150
6,8	150	30	10	1440 03 68150
6,8	225	30	10	1440 03 68225

Spiralbohrer-Bits 1/4" Schaft HSS-G geschliffen, Kreuzanschliff
Twist drill bits 1/4" hex-shank HSS-G fully ground, split point

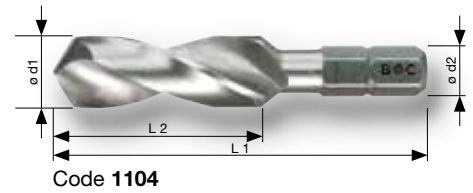

Code	P			M	K	N			S
	1.1 - 2.1	3.1 - 4.1	5.1	1.1 - 4.1	1.1 - 4.2	1.1 - 1.6	2.1 - 2.6	4.2	1.1 - 2.6
1104									

Optimal für Bohrarbeiten mit Akkuschauber in Metall, z.B. Stahl, Grauguss, Sinterisen, etc. Schnelles Umstecken durch speziellen 1/4" Sechskant-Schaft. Passt in jeden Universal-Bithalter, jedoch auch in konventionellem 3-Backen-Bohrfutter einsetzbar.

Especially for working with cordless machines in metal like steel, cast-iron, etc. The special bit shank allows quick change of tool. Fits in all bitholders, but can be used for conventional drill chucks, too.

Ø d1 mm	L 1 mm	L 2 mm	Ø d2		Artikel-Nr. Part-No.
1,0	32	7	1/4" / 6,35 mm	1	1104 07 00100
1,5	32	10	1/4" / 6,35 mm	1	1104 07 00150
2,0	34	12	1/4" / 6,35 mm	1	1104 07 00200
2,5	36	14	1/4" / 6,35 mm	1	1104 07 00250
3,0	38	16	1/4" / 6,35 mm	1	1104 07 00300
3,3	40	18	1/4" / 6,35 mm	1	1104 07 00330
3,5	40	18	1/4" / 6,35 mm	1	1104 07 00350
4,0	44	20	1/4" / 6,35 mm	1	1104 07 00400
4,2	45	20	1/4" / 6,35 mm	1	1104 07 00420
4,5	46	24	1/4" / 6,35 mm	1	1104 07 00450
5,0	50	26	1/4" / 6,35 mm	1	1104 07 00500
5,5	50	26	1/4" / 6,35 mm	1	1104 07 00550
6,0	50	30	1/4" / 6,35 mm	1	1104 07 00600
6,5	50	30	1/4" / 6,35 mm	1	1104 07 00650
6,8	50	30	1/4" / 6,35 mm	1	1104 07 00680
7,0	50	30	1/4" / 6,35 mm	1	1104 07 00700
7,5	51	32	1/4" / 6,35 mm	1	1104 07 00750
8,0	51	32	1/4" / 6,35 mm	1	1104 07 00800
8,5	53	33	1/4" / 6,35 mm	1	1104 07 00850
9,0	53	33	1/4" / 6,35 mm	1	1104 07 00900
9,5	54	38	1/4" / 6,35 mm	1	1104 07 00950
10,0	54	38	1/4" / 6,35 mm	1	1104 07 01000
10,2	54	38	1/4" / 6,35 mm	1	1104 07 01020

BC Multi-Pack / BC Multi-Pack

Bezeichnung Description	Teile Pieces	Inhalt Content	Artikel-Nr. Part-No.
MG 5-Bit	5	Ø 4 · 5 · 6 · 8 · 10 mm	1104 13 30005



MG 5-Bit



SPIRALBOHRER
TWIST DRILLS

Anbohrer / Stoßbohrer HSS-G **geschliffen**, extra kurz, Kreuzanschliff
 Rivet drills HSS-G **fully ground**, extra short, split point

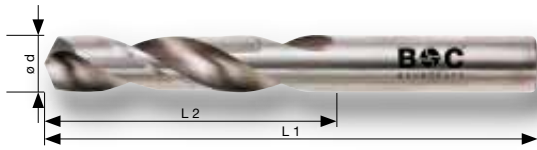

Code 1200



Code	P			M	K	N		S
	1.1 - 2.1	3.1 - 4.1	5.1	1.1 - 4.1	1.1 - 4.2	1.1 - 1.6	2.1 - 2.6	4.2
1200	⊗				⊗	⊗	⊗	⊗

Extra kurzer Spiralbohrer (kürzer als DIN 1897) speziell zum Einsatz in dünnwandigen Materialien wie Blech, Flach- und Profileisen.

Extra short twist drill (shorter than DIN 1897) suitable for drilling sheet-metal, flat-steel and profiles.

Ø d mm	L 1 mm	L 2 mm		Artikel-Nr. Part-No.
3,00	31	13	10	1200 03 00300
3,20	31	13	10	1200 03 00320
3,25	38	15	10	1200 03 00325
3,30	38	15	10	1200 03 00330
3,50	40	15	10	1200 03 00350
3,80	40	15	10	1200 03 00380
4,00	40	15	10	1200 03 00400
4,10	42	16	10	1200 03 00410
4,20	42	16	10	1200 03 00420
4,50	45	18	10	1200 03 00450
4,80	48	20	10	1200 03 00480
4,90	48	20	10	1200 03 00490
5,00	50	22	10	1200 03 00500
5,10	50	22	10	1200 03 00510
5,20	50	22	10	1200 03 00520
5,30	50	22	10	1200 03 00530
5,50	50	22	10	1200 03 00550
5,70	52	24	10	1200 03 00570
6,00	52	24	10	1200 03 00600



SPIRALBOHRER
TWIST DRILLS

Spiralbohrer DIN 1897 HSS-G geschliffen, Kreuzanschliff
Twist drills DIN 1897 HSS-G fully ground, split point

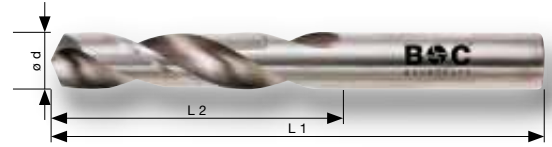

Code 1250



Code	P			M	K	N			S
	1.1 - 2.1	3.1 - 4.1	5.1	1.1 - 4.1	1.1 - 4.2	1.1 - 1.6	2.1 - 2.6	4.2	1.1 - 2.6
1250	☉				☉	☉	☉	☉	☉

Kurzer Spiralbohrer speziell zum Einsatz in dünnwandigen Materialien wie Blech, Flach- und Profileisen.

Short and robust fully-ground stub-drills, suitable for drilling sheet-metal, flat-steel and profiles.

Ø d mm	L 1 mm	L 2 mm		Artikel-Nr. Part-No.
2,00	38	12	10	1250 01 00200
2,50	43	14	10	1250 01 00250
2,70*	46	16	10	1250 01 00270
2,80	46	16	10	1250 01 00280
3,00	46	16	10	1250 01 00300
3,20	49	18	10	1250 01 00320
3,25	49	18	10	1250 01 00325
3,30	49	18	10	1250 01 00330
3,50	52	20	10	1250 01 00350
3,60*	52	20	10	1250 01 00360
3,80	55	22	10	1250 01 00380
4,00	55	22	10	1250 01 00400
4,10	55	22	10	1250 01 00410
4,20	55	22	10	1250 01 00420
4,50	58	24	10	1250 01 00450
4,80	62	26	10	1250 01 00480
4,90	62	26	10	1250 01 00490
5,00	62	26	10	1250 01 00500
5,10	62	26	10	1250 01 00510
5,20	62	26	10	1250 01 00520
5,50	66	28	10	1250 01 00550
5,70*	66	28	10	1250 01 00570
6,00	66	28	10	1250 01 00600
6,50	70	31	10	1250 01 00650
7,00	74	34	10	1250 01 00700
7,50	74	34	10	1250 01 00750
8,00	79	37	10	1250 01 00800
8,50	79	37	10	1250 01 00850
9,00	84	40	10	1250 01 00900
9,50	84	40	10	1250 01 00950
10,00	89	43	10	1250 01 01000
10,50	89	43	5	1250 01 01050
11,00	95	47	5	1250 01 01100
11,50	95	47	5	1250 01 01150
12,00	102	51	5	1250 01 01200
12,50	102	51	5	1250 01 01250
13,00	102	51	5	1250 01 01300

* Nur solange Vorrat reicht / * Only as long as stock lasts



SPIRALBOHRER
TWIST DRILLS

Spiralbohrer DIN 1897 HSS-G Typ N geschliffen, Kreuzanschliff

Twist drills DIN 1897 HSS-G type N fully ground, split point

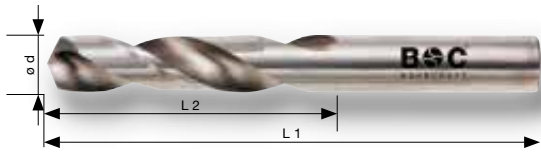

Code 1255



Code	P			M	K	N		S
	1.1 - 2.1	3.1 - 4.1	5.1	1.1 - 4.1	1.1 - 4.2	1.1 - 1.6	2.1 - 2.6	4.2
1255	⊗	⊗			⊗	⊗	⊗	⊗

Für Stahl und Stahlguss legiert und unlegiert, Grau- und Temperguss, Sphäro- und Druckguss, Sintereisen, Graphit, kurzspanende Aluminiumlegierungen, Messing und Bronze.

For steel and cast steel alloyed and unalloyed, cast iron, annealed cast iron, ductile graphite iron, diecast, short-chipping aluminium-alloy, brass and bronze.

Ø d mm	L 1 mm	L 2 mm	⊗	Artikel-Nr. Part-No.
2,00	38	12	10	1255 03 00200
2,50	43	14	10	1255 03 00250
2,80	46	16	10	1255 03 00280
3,00	46	16	10	1255 03 00300
3,10	49	18	10	1255 03 00310
3,20	49	18	10	1255 03 00320
3,25	49	18	10	1255 03 00325
3,30	49	18	10	1255 03 00330
3,40	52	20	10	1255 03 00340
3,50	52	20	10	1255 03 00350
3,60	52	20	10	1255 03 00360
3,70	52	20	10	1255 03 00370
3,80	55	22	10	1255 03 00380
3,90	55	22	10	1255 03 00390
4,00	55	22	10	1255 03 00400
4,10	55	22	10	1255 03 00410
4,20	55	22	10	1255 03 00420
4,30	58	24	10	1255 03 00430
4,40	58	24	10	1255 03 00440
4,50	58	24	10	1255 03 00450
4,60	58	24	10	1255 03 00460
4,70	58	24	10	1255 03 00470
4,80	62	26	10	1255 03 00480
4,90	62	26	10	1255 03 00490
5,00	62	26	10	1255 03 00500
5,10	62	26	10	1255 03 00510
5,20	62	26	10	1255 03 00520
5,30	62	26	10	1255 03 00530
5,40	66	28	10	1255 03 00540
5,50	66	28	10	1255 03 00550
5,60	66	28	10	1255 03 00560
5,70	66	28	10	1255 03 00570
5,80	66	28	10	1255 03 00580
5,90	66	28	10	1255 03 00590
6,00	66	28	10	1255 03 00600
6,50	70	31	10	1255 03 00650
6,80	74	34	10	1255 03 00680
7,00	74	34	10	1255 03 00700
7,50	74	34	5	1255 03 00750
8,00	79	37	5	1255 03 00800
8,50	79	37	5	1255 03 00850
9,00	84	40	5	1255 03 00900
9,50	84	40	5	1255 03 00950
10,00	89	43	5	1255 03 01000
10,20	89	43	5	1255 03 01020
10,50	89	43	5	1255 03 01050
11,00	95	47	5	1255 03 01100
11,50	95	47	5	1255 03 01150
12,00	102	51	5	1255 03 01200
12,50	102	51	5	1255 03 01250
13,00	102	51	5	1255 03 01300

Spiralbohrer DIN 1897 HSS-E (Co5) kobaltlegiert, Kreuzanschliff
Twist drills DIN 1897 HSS-E (Co5) cobalt alloyed, split point

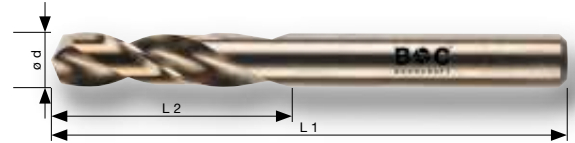

Code 1260



Code	P			M	K	N		S
	1.1 - 2.1	3.1 - 4.1	5.1	1.1 - 2.1	1.1 - 4.2	1.1 - 1.6	2.1 - 2.6	4.2
1260	☉	☉		☉	☉	☉	☉	☉

Spiralbohrer mit höherer Warmhärtebeständigkeit, zum Bohren von rost-, säure- und hitzebeständigen Stählen.

Twist drill with higher heat resistance, for drilling stainless steels and heat resistant steels.

Ø d mm	L 1 mm	L 2 mm		Artikel-Nr. Part-No.
2,00	38	12	10	1260 01 00200
2,50	43	14	10	1260 01 00250
2,70*	46	16	10	1260 01 00270
3,00	46	16	10	1260 01 00300
3,10	49	18	10	1260 01 00310
3,20	49	18	10	1260 01 00320
3,25	49	18	10	1260 01 00325
3,30	49	18	10	1260 01 00330
3,40*	52	20	10	1260 01 00340
3,50	52	20	10	1260 01 00350
4,00	55	22	10	1260 01 00400
4,10	55	22	10	1260 01 00410
4,20	55	22	10	1260 01 00420
4,50	58	24	10	1260 01 00450
4,70*	58	24	10	1260 01 00470
4,80	62	26	10	1260 01 00480
4,90	62	26	10	1260 01 00490
5,00	62	26	10	1260 01 00500
5,10	62	26	10	1260 01 00510
5,20	62	26	10	1260 01 00520
5,50	66	28	10	1260 01 00550
5,80*	66	28	10	1260 01 00580
6,00	66	28	10	1260 01 00600
6,50	70	31	10	1260 01 00650
7,00	74	34	10	1260 01 00700
7,50	74	34	10	1260 01 00750
8,00	79	37	10	1260 01 00800
8,50	79	37	10	1260 01 00850
9,00	84	40	10	1260 01 00900
9,50	84	40	10	1260 01 00950
10,00	89	43	10	1260 01 01000
10,20*	89	43	5	1260 01 01020
10,50	89	43	5	1260 01 01050
11,00	95	47	5	1260 01 01100
11,50	95	47	5	1260 01 01150
12,00	102	51	5	1260 01 01200
12,50	102	51	5	1260 01 01250
13,00	102	51	5	1260 01 01300

* Nur solange Vorrat reicht / * Only as long as stock lasts



SPIRALBOHRER
TWIST DRILLS

Spiralbohrer DIN 1897 HSS-E (Co5) Typ N kobaltlegiert, Kreuzanschliff
 Twist drills DIN 1897 HSS-E (Co5) type N cobalt alloyed, split point

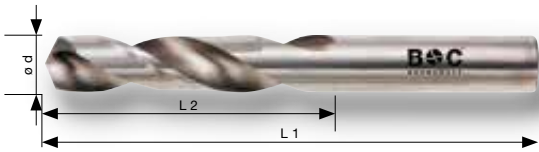

Code 1265



Code 1266 TiN

DIN 1897
HSS-E Co5
Typ N
VA INOX
130°
SPLIT POINT
3xD
TiN

Code	P			M	K	N		S
	1.1 - 2.1	3.1 - 4.1	5.1	1.1 - 2.1	1.1 - 4.2	1.1 - 1.6	2.1 - 2.6	4.2
1265	⊗	⊗	⊗	⊗	⊗	⊗	⊗	⊗
1266	⊗	⊗	⊗	⊗	⊗			⊗

Premium Spiralbohrer für Stahl und Stahlguss legiert und unlegiert, V2A und V4A Stahl, Warm- und Kaltarbeitsstahl, Wälzlagerstahl.

Premium twist drill for steel and cast steel alloyed and unalloyed, stainless steel like AISI 304 + 316, hot and cold working steel and bearing steel.



SPIRALBOHRER
TWIST DRILLS

Ø d mm	L 1 mm	L 2 mm	⊗	TiN	
				Artikel-Nr. Part-No.	Artikel-Nr. Part-No.
2,00	38	12	10	1265 03 00200	1266 03 00200
2,50	43	14	10	1265 03 00250	1266 03 00250
2,80	46	16	10	1265 03 00280	1266 03 00280
3,00	46	16	10	1265 03 00300	1266 03 00300
3,10	49	18	10	1265 03 00310	1266 03 00310
3,20	49	18	10	1265 03 00320	1266 03 00320
3,25	49	18	10	1265 03 00325	1266 03 00325
3,30	49	18	10	1265 03 00330	1266 03 00330
3,40	52	20	10	1265 03 00340	1266 03 00340
3,50	52	20	10	1265 03 00350	1266 03 00350
3,60	52	20	10	1265 03 00360	1266 03 00360
3,70	52	20	10	1265 03 00370	1266 03 00370
3,80	55	22	10	1265 03 00380	1266 03 00380
3,90	55	22	10	1265 03 00390	1266 03 00390
4,00	55	22	10	1265 03 00400	1266 03 00400
4,10	55	22	10	1265 03 00410	1266 03 00410
4,20	55	22	10	1265 03 00420	1266 03 00420
4,30	58	24	10	1265 03 00430	1266 03 00430
4,40	58	24	10	1265 03 00440	1266 03 00440
4,50	58	24	10	1265 03 00450	1266 03 00450
4,60	58	24	10	1265 03 00460	1266 03 00460
4,70	58	24	10	1265 03 00470	1266 03 00470
4,80	62	26	10	1265 03 00480	1266 03 00480
4,90	62	26	10	1265 03 00490	1266 03 00490
5,00	62	26	10	1265 03 00500	1266 03 00500
5,10	62	26	10	1265 03 00510	1266 03 00510
5,20	62	26	10	1265 03 00520	1266 03 00520
5,30	62	26	10	1265 03 00530	1266 03 00530
5,40	66	28	10	1265 03 00540	1266 03 00540
5,50	66	28	10	1265 03 00550	1266 03 00550
5,60	66	28	10	1265 03 00560	1266 03 00560
5,70	66	28	10	1265 03 00570	1266 03 00570
5,80	66	28	10	1265 03 00580	1266 03 00580
5,90	66	28	10	1265 03 00590	1266 03 00590
6,00	66	28	10	1265 03 00600	1266 03 00600
6,50	70	31	10	1265 03 00650	1266 03 00650
6,80	74	34	10	1265 03 00680	1266 03 00680
7,00	74	34	10	1265 03 00700	1266 03 00700
7,50	74	34	5	1265 03 00750	1266 03 00750
8,00	79	37	5	1265 03 00800	1266 03 00800
8,50	79	37	5	1265 03 00850	1266 03 00850
9,00	84	40	5	1265 03 00900	1266 03 00900
9,50	84	40	5	1265 03 00950	1266 03 00950
10,00	89	43	5	1265 03 01000	1266 03 01000
10,20	89	43	5	1265 03 01020	1266 03 01020
10,50	89	43	5	1265 03 01050	1266 03 01050
11,00	95	47	5	1265 03 01100	1266 03 01100
11,50	95	47	5	1265 03 01150	1266 03 01150
12,00	102	51	5	1265 03 01200	1266 03 01200
12,50	102	51	5	1265 03 01250	1266 03 01250
13,00	102	51	5	1265 03 01300	1266 03 01300

Zentrierbohrer DIN 333 A 60° HSS-G geschliffen
Centre drills DIN 333 A 60° HSS-G fully ground



Code	P			M	K	N		S
	1.1 - 2.1	3.1 - 4.1	5.1	1.1 - 4.1	1.1 - 4.2	1.1 - 1.6	2.1 - 2.6	4.2
1600	☉				☉	☉	☉	☉

Zentrierbohrer zum Herstellen von Zentrierbohrungen 60° nach DIN 332.

Centre drills for 60° centering holes acc. to DIN 332.

Ø d1 mm	Ø d2 mm	L mm		Artikel-Nr. Part-No.
0,80	3,15	25,0	1	1600 03 00080
1,00	3,15	31,5	1	1600 03 00100
1,25	3,15	31,5	1	1600 03 00125
1,60	4,00	35,5	1	1600 03 00160
2,00	5,00	40,0	1	1600 03 00200
2,50	6,30	45,0	1	1600 03 00250
3,15	8,00	50,0	1	1600 03 00315
4,00	10,00	56,0	1	1600 03 00400
5,00	12,50	63,0	1	1600 03 00500
6,30	16,00	71,0	1	1600 03 00630
8,00	20,00	80,0	1	1600 03 00800
10,00	25,00	100,0	1	1600 03 01000



SPIRALBOHRER
TWIST DRILLS

Doppelendbohrer HSS-G geschliffen, Kreuzanschliff
 Double ended drills HSS-G fully ground, split point



Code 1300



Code	P			M	K	N		S
	1.1 - 2.1	3.1 - 4.1	5.1	1.1 - 4.1	1.1 - 4.2	1.1 - 1.6	2.1 - 2.6	4.2
1300	⊗				⊗	⊗	⊗	⊗

Besonders geeignet für dünnwandige Materialien, z.B. Blech, Flacheisen und Profile.

Especially designed for drilling thin materials like sheet-metal, flat-steel, profiles, etc.

Ø d mm	L 1 mm	L 2 mm		Artikel-Nr. Part-No.
2,00	43	13	10	1300 01 00200
2,50	43	13	10	1300 01 00250
3,00	46	13	10	1300 01 00300
3,10	49	13	10	1300 01 00310
3,20	49	13	10	1300 01 00320
3,25	49	13	10	1300 01 00325
3,30	49	13	10	1300 01 00330
3,50	49	13	10	1300 01 00350
4,00	52	16	10	1300 01 00400
4,10	55	16	10	1300 01 00410
4,20	55	16	10	1300 01 00420
4,50	58	16	10	1300 01 00450
4,90	62	16	10	1300 01 00490
5,00	62	16	10	1300 01 00500
5,10	62	16	10	1300 01 00510
5,20	62	16	10	1300 01 00520
5,50	66	19	10	1300 01 00550
6,00	66	19	10	1300 01 00600

SPIRALBOHRER
TWIST DRILLS

Doppelendbohrer HSS-G geschliffen, Kreuzanschliff Double ended drills HSS-G fully ground, split point



Code 1301



Code	P			M	K	N		S
	1.1 - 2.1	3.1 - 4.1	5.1	1.1 - 4.1	1.1 - 4.2	1.1 - 1.6	2.1 - 2.6	4.2
1301	☉	☉			☉	☉	☉	☉

Besonders geeignet für dünnwandige Materialien wie Blech, Flacheisen und Profile.

Especially designed for drilling in thin materials like sheet metal, flat-steel and profiles.

Ø d mm	L 1 mm	L 2 mm	📏	Artikel-Nr. Part-No.
2,00	38	7,5	10	1301 03 00200
2,50	43	9,5	10	1301 03 00250
2,70	46	9,5	10	1301 03 00270
3,00	46	9,5	10	1301 03 00300
3,10	49	9,5	10	1301 03 00310
3,20	49	9,5	10	1301 03 00320
3,25	49	9,5	10	1301 03 00325
3,30	49	9,5	10	1301 03 00330
3,50	52	13,0	10	1301 03 00350
3,80	55	13,0	10	1301 03 00380
4,00	55	13,0	10	1301 03 00400
4,10	55	13,0	10	1301 03 00410

Ø d mm	L 1 mm	L 2 mm	📏	Artikel-Nr. Part-No.
4,20	55	13,0	10	1301 03 00420
4,50	58	16,0	10	1301 03 00450
4,80	62	16,0	10	1301 03 00480
4,90	62	16,0	10	1301 03 00490
5,00	62	16,0	10	1301 03 00500
5,10	62	16,0	10	1301 03 00510
5,20	62	16,0	10	1301 03 00520
5,50	66	16,0	10	1301 03 00550
6,00	66	16,0	10	1301 03 00600
6,50	70	18,0	10	1301 03 00650
7,00	74	19,0	10	1301 03 00700
8,00	79	20,0	5	1301 03 00800

Doppelendbohrer HSS-E (Co5) kobaltlegiert, Kreuzanschliff Double ended drills HSS-E (Co5) cobalt alloyed, split point



Code 1310

Code	P			M	K	N		S
	1.1 - 2.1	3.1 - 4.1	5.1	1.1 - 2.1	1.1 - 4.2	1.1 - 1.6	2.1 - 2.6	4.2
1310	☉	☉	☉	☉	☉	☉	☉	☉

Besonders geeignet für dünnwandige Materialien wie Blech, Flacheisen und Profile. 5 % kobaltlegierte Ausführung für eine deutlich höhere Standzeit!

Especially designed for drilling in thin materials like sheet metal, flat-steel and profiles. 5 % cobalt-alloyed version for considerable longer tool life!

Ø d mm	L 1 mm	L 2 mm	📏	Artikel-Nr. Part-No.
3,20	49	12	10	1310 03 00320
3,25	49	12	10	1310 03 00325
3,30	49	12	10	1310 03 00330
4,10	55	14	10	1310 03 00410
4,20	55	14	10	1310 03 00420
4,90	62	17	10	1310 03 00490
5,10	62	17	10	1310 03 00510
5,20	62	17	10	1310 03 00520

Spiralbohrer DIN 345 HSS

Taper shank drills DIN 345 HSS

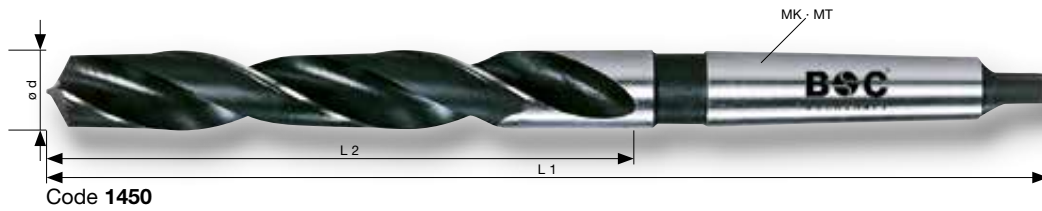

Code 1450



Code	P			M	K	N		S
	1.1 - 2.1	3.1 - 4.1	5.1	1.1 - 4.1	1.1 - 4.2	1.1 - 1.6	2.1 - 2.6	4.2
1450	☉				☉	☉	☉	☉

MK-Spiralbohrer zum Bohren von Stahl und Stahlguss, sowie NE-Metallen. Dampfangelassen und außen poliert.

Twist drills with Morse taper shank for use in steel and cast-steel as well as non-ferrous materials. Steam tempered and outside polished.

Ø d mm	L 1 mm	L 2 mm	MK MT		Artikel-Nr. Part-No.
10,0	168	87	1	1	1450 03 01000
10,2	168	87	1	1	1450 03 01020
10,5	168	87	1	1	1450 03 01050
11,0	175	94	1	1	1450 03 01100
11,5	175	94	1	1	1450 03 01150
12,0	182	101	1	1	1450 03 01200
12,5	182	101	1	1	1450 03 01250
13,0	182	101	1	1	1450 03 01300
13,5	189	108	1	1	1450 03 01350
14,0	189	108	1	1	1450 03 01400
14,5	212	114	2	1	1450 03 01450
15,0	212	114	2	1	1450 03 01500
15,5	218	120	2	1	1450 03 01550
16,0	218	120	2	1	1450 03 01600
16,5	223	125	2	1	1450 03 01650
17,0	228	130	2	1	1450 03 01700
17,5	228	130	2	1	1450 03 01750
18,0	228	130	2	1	1450 03 01800
18,5	233	135	2	1	1450 03 01850
19,0	233	135	2	1	1450 03 01900
19,5	238	140	2	1	1450 03 01950
20,0	238	140	2	1	1450 03 02000
20,5	243	145	2	1	1450 03 02050
21,0	243	145	2	1	1450 03 02100
21,5	248	150	2	1	1450 03 02150
22,0	248	150	2	1	1450 03 02200
22,5	253	155	2	1	1450 03 02250
23,0	253	155	2	1	1450 03 02300
23,5	276	155	3	1	1450 03 02350
24,0	281	160	3	1	1450 03 02400
24,5	281	160	3	1	1450 03 02450
25,0	281	160	3	1	1450 03 02500
25,5	286	165	3	1	1450 03 02550
26,0	286	165	3	1	1450 03 02600
26,5	286	165	3	1	1450 03 02650
27,0	291	170	3	1	1450 03 02700
27,5	291	170	3	1	1450 03 02750
28,0	291	170	3	1	1450 03 02800
28,5	296	175	3	1	1450 03 02850
29,0	296	175	3	1	1450 03 02900
29,5	296	175	3	1	1450 03 02950
30,0	296	175	3	1	1450 03 03000
30,5	301	180	3	1	1450 03 03050
31,0	301	180	3	1	1450 03 03100
31,5	301	180	3	1	1450 03 03150
32,0	334	185	4	1	1450 03 03200
32,5	334	185	4	1	1450 03 03250
33,0	334	185	4	1	1450 03 03300
33,5	334	185	4	1	1450 03 03350
34,0	339	190	4	1	1450 03 03400
34,5	339	190	4	1	1450 03 03450
35,0	339	190	4	1	1450 03 03500
35,5	339	190	4	1	1450 03 03550

SPIRALBOHRER
TWIST DRILLS

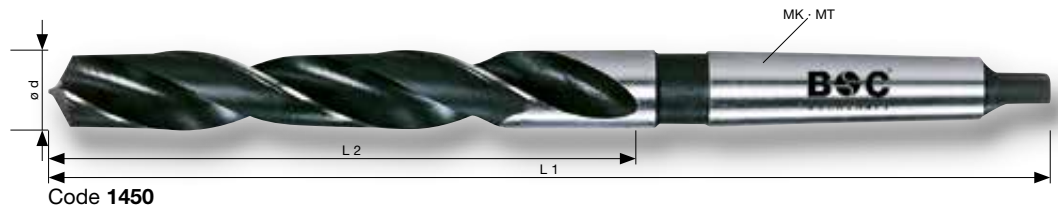

Ø d mm	L 1 mm	L 2 mm	MK MT		Artikel-Nr. Part-No.
36,0	344	195	4	1	1450 03 03600
36,5	344	195	4	1	1450 03 03650
37,0	344	195	4	1	1450 03 03700
37,5	344	195	4	1	1450 03 03750
38,0	349	200	4	1	1450 03 03800
38,5	349	200	4	1	1450 03 03850
39,0	349	200	4	1	1450 03 03900
39,5	349	200	4	1	1450 03 03950
40,0	349	200	4	1	1450 03 04000
40,5	354	205	4	1	1450 03 04050
41,0	354	205	4	1	1450 03 04100
41,5	354	205	4	1	1450 03 04150
42,0	354	205	4	1	1450 03 04200
42,5	354	205	4	1	1450 03 04250
43,0	359	210	4	1	1450 03 04300
43,5	359	210	4	1	1450 03 04350
44,0	359	210	4	1	1450 03 04400
44,5	359	210	4	1	1450 03 04450
45,0	359	210	4	1	1450 03 04500
45,5	364	215	4	1	1450 03 04550
46,0	364	215	4	1	1450 03 04600
46,5	364	215	4	1	1450 03 04650
47,0	364	215	4	1	1450 03 04700
47,5	364	215	4	1	1450 03 04750
48,0	369	220	4	1	1450 03 04800
48,5	369	220	4	1	1450 03 04850
49,0	369	220	4	1	1450 03 04900
49,5	369	220	4	1	1450 03 04950
50,0	369	220	4	1	1450 03 05000
51,0	412	225	5	1	1450 15 05100
52,0	412	225	5	1	1450 15 05200
53,0	412	225	5	1	1450 15 05300
54,0	417	230	5	1	1450 15 05400
55,0	417	230	5	1	1450 15 05500
56,0	417	230	5	1	1450 15 05600
57,0	422	235	5	1	1450 15 05700
58,0	422	235	5	1	1450 15 05800
59,0	422	235	5	1	1450 15 05900
60,0	422	235	5	1	1450 15 06000

BC Industrie-Kassetten / BC Metal-Boxes

Bezeichnung Description	Teile Pieces	Inhalt Content	Artikel-Nr. Part-No.
MK 10-1	10	Ø 14 · 15 · 16 · 17 · 18 · 19 · 20 · 21 · 22 · 23 mm	1450 14 10001
MK 10-2	10	Ø 14 · 16 · 18 · 20 · 22 · 24 · 25 · 26 · 28 · 30 mm	1450 14 10002



MK 10-1



SPIRALBOHRER
TWIST DRILLS

Spiralbohrer DIN 345 HSS gefräst

Taper shank drills DIN 345 HSS milled

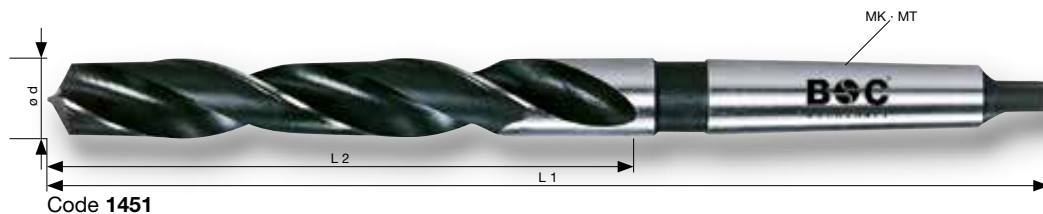

Code 1451



Code	P			M	K	N			S
	1.1 - 2.1	3.1 - 4.1	5.1	1.1 - 4.1	1.1 - 4.2	1.1 - 1.6	2.1 - 2.6	4.2	1.1 - 2.6
1451	⊗				⊗	⊗	⊗	⊗	⊗

Gefräster MK-Spiralbohrer zum Bohren von Stahl und Stahlguss, NE-Metallen, Grauguss, Temperguss, Sphäroguss und Sintereisen.

Milled Morse taper shank drills for drilling steel and cast-steel, non-ferrous metals, grey cast-iron, nodular cast-iron and sintered iron.

Ø d mm	L 1 mm	L 2 mm	MK MT		Artikel-Nr. Part-No.
6,00	138	57	1	1	1451 03 00600
6,50	144	63	1	1	1451 03 00650
7,00	150	69	1	1	1451 03 00700
7,50	150	69	1	1	1451 03 00750
8,00	156	75	1	1	1451 03 00800
8,50	156	75	1	1	1451 03 00850
9,00	162	81	1	1	1451 03 00900
9,50	162	81	1	1	1451 03 00950
10,00	168	87	1	1	1451 03 01000
10,25	168	87	1	1	1451 03 01025
10,50	168	87	1	1	1451 03 01050
10,75	175	94	1	1	1451 03 01075
11,00	175	94	1	1	1451 03 01100
11,25	175	94	1	1	1451 03 01125
11,50	175	94	1	1	1451 03 01150
11,75	182	101	1	1	1451 03 01175
12,00	182	101	1	1	1451 03 01200
12,25	182	101	1	1	1451 03 01225
12,50	182	101	1	1	1451 03 01250
12,75	182	101	1	1	1451 03 01275
13,00	182	101	1	1	1451 03 01300
13,25	189	108	1	1	1451 03 01325
13,50	189	108	1	1	1451 03 01350
13,75	189	108	1	1	1451 03 01375
14,00	189	108	1	1	1451 03 01400
14,25	212	114	2	1	1451 03 01425
14,50	212	114	2	1	1451 03 01450
14,75	212	114	2	1	1451 03 01475
15,00	212	114	2	1	1451 03 01500
15,25	218	120	2	1	1451 03 01525
15,50	218	120	2	1	1451 03 01550
15,75	218	120	2	1	1451 03 01575
16,00	218	120	2	1	1451 03 01600
16,25	223	125	2	1	1451 03 01625
16,50	223	125	2	1	1451 03 01650
16,75	223	125	2	1	1451 03 01675
17,00	228	130	2	1	1451 03 01700
17,25	228	130	2	1	1451 03 01725
17,50	228	130	2	1	1451 03 01750
17,75	228	130	2	1	1451 03 01775
18,00	228	130	2	1	1451 03 01800
18,25	233	135	2	1	1451 03 01825
18,50	233	135	2	1	1451 03 01850
18,75	233	135	2	1	1451 03 01875
19,00	233	135	2	1	1451 03 01900
19,25	238	140	2	1	1451 03 01925
19,50	238	140	2	1	1451 03 01950
19,75	238	140	2	1	1451 03 01975
20,00	238	140	2	1	1451 03 02000
20,25	243	145	2	1	1451 03 02025
20,50	243	145	2	1	1451 03 02050
20,75	243	145	2	1	1451 03 02075
21,00	243	145	2	1	1451 03 02100

Ø d mm	L 1 mm	L 2 mm	MK MT		Artikel-Nr. Part-No.
21,25	248	150	2	1	1451 03 02125
21,50	248	150	2	1	1451 03 02150
21,75	248	150	2	1	1451 03 02175
22,00	248	150	2	1	1451 03 02200
22,25	253	155	2	1	1451 03 02225
22,50	253	155	2	1	1451 03 02250
22,75	253	155	2	1	1451 03 02275
23,00	253	155	2	1	1451 03 02300
23,25	276	155	3	1	1451 03 02325
23,50	276	155	3	1	1451 03 02350
23,75	281	160	3	1	1451 03 02375
24,00	281	160	3	1	1451 03 02400
24,25	281	160	3	1	1451 03 02425
24,50	281	160	3	1	1451 03 02450
24,75	281	160	3	1	1451 03 02475
25,00	281	160	3	1	1451 03 02500
25,25	286	165	3	1	1451 03 02525
25,50	286	165	3	1	1451 03 02550
25,75	286	165	3	1	1451 03 02575
26,00	286	165	3	1	1451 03 02600
26,25	286	165	3	1	1451 03 02625
26,50	286	165	3	1	1451 03 02650
26,75	291	170	3	1	1451 03 02675
27,00	291	170	3	1	1451 03 02700
27,25	291	170	3	1	1451 03 02725
27,50	291	170	3	1	1451 03 02750
27,75	291	170	3	1	1451 03 02775
28,00	291	170	3	1	1451 03 02800
28,25	296	175	3	1	1451 03 02825
28,50	296	175	3	1	1451 03 02850
28,75	296	175	3	1	1451 03 02875
29,00	296	175	3	1	1451 03 02900
29,25	296	175	3	1	1451 03 02925
29,50	296	175	3	1	1451 03 02950
29,75	296	175	3	1	1451 03 02975
30,00	296	175	3	1	1451 03 03000
30,50	301	180	3	1	1451 03 03050
31,00	301	180	3	1	1451 03 03100
31,50	301	180	3	1	1451 03 03150
32,00	334	185	4	1	1451 03 03200
32,50	334	185	4	1	1451 03 03250
33,00	334	185	4	1	1451 03 03300
33,50	334	185	4	1	1451 03 03350
34,00	339	190	4	1	1451 03 03400
34,50	339	190	4	1	1451 03 03450
35,00	339	190	4	1	1451 03 03500
35,50	339	190	4	1	1451 03 03550
36,00	344	195	4	1	1451 03 03600
36,50	344	195	4	1	1451 03 03650
37,00	344	195	4	1	1451 03 03700
37,50	344	195	4	1	1451 03 03750
38,00	349	200	4	1	1451 03 03800
38,50	349	200	4	1	1451 03 03850

Spiralbohrer DIN 345 HSS gefräst
Taper shank drills DIN 345 HSS milled

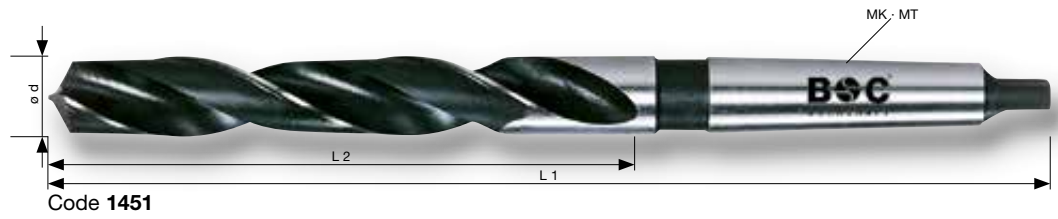

Ø d mm	L 1 mm	L 2 mm	MK MT		Artikel-Nr. Part-No.
39,00	349	200	4	1	1451 03 03900
39,50	349	200	4	1	1451 03 03950
40,00	349	200	4	1	1451 03 04000
40,50	354	205	4	1	1451 03 04050
41,00	354	205	4	1	1451 03 04100
41,50	354	205	4	1	1451 03 04150
42,00	354	205	4	1	1451 03 04200
42,50	354	205	4	1	1451 03 04250
43,00	359	210	4	1	1451 03 04300
43,50	359	210	4	1	1451 03 04350
44,00	359	210	4	1	1451 03 04400
44,50	359	210	4	1	1451 03 04450
45,00	359	210	4	1	1451 03 04500
45,50	364	215	4	1	1451 03 04550
46,00	364	215	4	1	1451 03 04600
46,50	364	215	4	1	1451 03 04650
47,00	364	215	4	1	1451 03 04700
47,50	364	215	4	1	1451 03 04750
48,00	369	220	4	1	1451 03 04800
48,50	369	220	4	1	1451 03 04850
49,00	369	220	4	1	1451 03 04900
49,50	369	220	4	1	1451 03 04950
50,00	369	220	4	1	1451 03 05000
51,00	412	225	5	1	1451 15 05100
52,00	412	225	5	1	1451 15 05200

Ø d mm	L 1 mm	L 2 mm	MK MT		Artikel-Nr. Part-No.
53,00	412	225	5	1	1451 15 05300
54,00	417	230	5	1	1451 15 05400
55,00	417	230	5	1	1451 15 05500
56,00	417	230	5	1	1451 15 05600
57,00	422	235	5	1	1451 15 05700
58,00	422	235	5	1	1451 15 05800
59,00	422	235	5	1	1451 15 05900
60,00	422	235	5	1	1451 15 06000
61,00	427	240	5	1	1451 15 06100
62,00	427	240	5	1	1451 15 06200
63,00	427	240	5	1	1451 15 06300
65,00	432	245	5	1	1451 15 06500
66,00	432	245	5	1	1451 15 06600
67,00	432	245	5	1	1451 15 06700
69,00	437	250	5	1	1451 15 06900
70,00	437	250	5	1	1451 15 07000
72,00	442	255	5	1	1451 15 07200
75,00	442	255	5	1	1451 15 07500
76,00	447	260	5	1	1451 15 07600
79,00	514	260	6	1	1451 15 07900
80,00	514	260	6	1	1451 15 08000
85,00	519	265	6	1	1451 15 08500
90,00	525	270	6	1	1451 15 09000
100,00	534	280	6	1	1451 15 10000



SPIRALBOHRER
TWIST DRILLS

Spiralbohrer DIN 345 HSS-E (Co5) Typ N kobaltlegiert

Taper shank drills DIN 345 HSS-E (Co5) type N cobalt alloyed

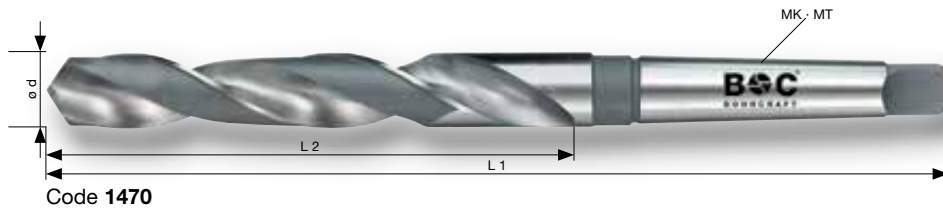

Code 1470

DIN 345	HSS-E Co5	Typ N	VA INOX	130°	DIN 1412 A	5xD
-------------------	---------------------	-----------------	-------------------	-------------	-------------------	------------

Code	P			M	K	N		S
	1.1 - 2.1	3.1 - 4.1	5.1	1.1 - 2.1	1.1 - 4.2	1.1 - 1.6	2.1 - 2.6	4.2
1470	☉	☉	☉	☉	☉	☉	☉	☉

MK-Spiralbohrer für Stahl und Stahlguss, Grau- und Temperguss, rostfreie Stähle wie V2A und V4A.

Twist drills with Morse taper shank for steel and cast steel, cast iron, malleable cast iron, stainless steel like AISI 304 + 316.

Ø d mm	L 1 mm	L 2 mm	MK MT		Artikel-Nr. Part-No.
10,0	168	87	1	1	1470 03 01000
11,0	175	94	1	1	1470 03 01100
11,5	175	94	1	1	1470 03 01150
12,0	182	101	1	1	1470 03 01200
12,5	182	101	1	1	1470 03 01250
13,0	182	101	1	1	1470 03 01300
13,5	189	108	1	1	1470 03 01350
14,0	189	108	1	1	1470 03 01400
14,5	212	114	2	1	1470 03 01450
15,0	212	114	2	1	1470 03 01500
15,5	218	120	2	1	1470 03 01550
16,0	218	120	2	1	1470 03 01600
16,5	223	125	2	1	1470 03 01650
17,0	228	130	2	1	1470 03 01700
17,5	228	130	2	1	1470 03 01750
18,0	228	130	2	1	1470 03 01800
18,5	233	135	2	1	1470 03 01850
19,0	233	135	2	1	1470 03 01900
19,5	238	140	2	1	1470 03 01950
20,0	238	140	2	1	1470 03 02000
20,5	243	145	2	1	1470 03 02050
21,0	243	145	2	1	1470 03 02100
21,5	248	150	2	1	1470 03 02150
22,0	248	150	2	1	1470 03 02200
22,5	253	155	2	1	1470 03 02250
23,0	253	155	2	1	1470 03 02300
23,5	276	155	3	1	1470 03 02350
24,0	281	160	3	1	1470 03 02400
24,5	281	160	3	1	1470 03 02450
25,0	281	160	3	1	1470 03 02500
26,0	286	165	3	1	1470 03 02600
27,0	291	170	3	1	1470 03 02700
27,5	291	170	3	1	1470 03 02750
28,0	291	170	3	1	1470 03 02800
28,5	296	175	3	1	1470 03 02850
29,0	296	175	3	1	1470 03 02900
29,5	296	175	3	1	1470 03 02950
30,0	296	175	3	1	1470 03 03000
31,0	301	180	3	1	1470 03 03100
32,0	334	185	4	1	1470 03 03200
33,0	334	185	4	1	1470 03 03300
34,0	339	190	4	1	1470 03 03400
35,0	339	190	4	1	1470 03 03500
36,0	344	195	4	1	1470 03 03600
37,0	344	195	4	1	1470 03 03700
38,0	349	200	4	1	1470 03 03800
39,0	349	200	4	1	1470 03 03900
40,0	349	200	4	1	1470 03 04000
45,0	359	210	4	1	1470 03 04500
50,0	369	220	4	1	1470 03 05000

SPIRALBOHRER
TWIST DRILLS

Spiralbohrer / Bohrbuchsenbohrer DIN 341 HSS Typ N gefräst, lange Ausführung
Taper Shank / Bushing drills DIN 341 HSS Type N milled, long series

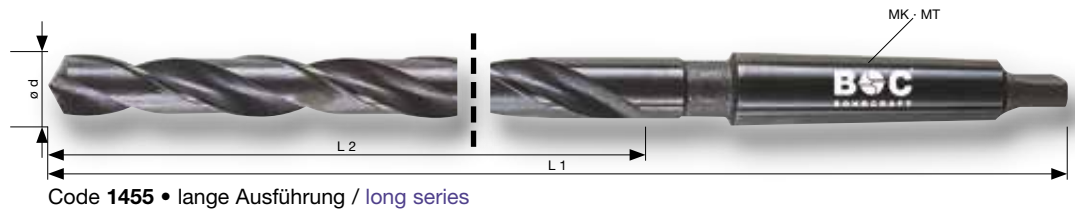

Code	P			M	K	N		S
	1.1 - 2.1	3.1 - 4.1	5.1	1.1 - 4.1	1.1 - 4.2	1.1 - 1.6	2.1 - 2.6	4.2
1455	☉	☉			☉	☉	☉	☉

MK-Spiralbohrer für Stahl und Stahlguss, NE-Metalle, Grau- und Temperguss, Sphäroguss, Sintereisen und Graphit.

Twist drills with Morse taper shank for steel and cast steel, cast iron, ductile graphite iron and diecast.

Ø d mm	L 1 mm	L 2 mm	MK MT		Artikel-Nr. Part-No.
10,0	197	116	1	1	1455 03 01000
10,5	197	116	1	1	1455 03 01050
11,0	206	125	1	1	1455 03 01100
11,5	206	125	1	1	1455 03 01150
12,0	215	134	1	1	1455 03 01200
12,5	215	134	1	1	1455 03 01250
13,0	215	134	1	1	1455 03 01300
13,5	223	142	1	1	1455 03 01350
14,0	223	142	1	1	1455 03 01400
14,5	245	147	2	1	1455 03 01450
15,0	245	147	2	1	1455 03 01500
15,5	251	153	2	1	1455 03 01550
16,0	251	153	2	1	1455 03 01600
16,5	257	159	2	1	1455 03 01650
17,0	257	159	2	1	1455 03 01700
17,5	263	165	2	1	1455 03 01750
18,0	263	165	2	1	1455 03 01800
18,5	269	171	2	1	1455 03 01850
19,0	269	171	2	1	1455 03 01900
19,5	275	177	2	1	1455 03 01950
20,0	275	177	2	1	1455 03 02000
20,5	282	184	2	1	1455 03 02050
21,0	282	184	2	1	1455 03 02100
21,5	289	191	2	1	1455 03 02150
22,0	289	191	2	1	1455 03 02200
22,5	296	198	2	1	1455 03 02250
23,0	296	198	2	1	1455 03 02300
23,5	319	198	3	1	1455 03 02350
24,0	327	206	3	1	1455 03 02400
24,5	327	206	3	1	1455 03 02450

Ø d mm	L 1 mm	L 2 mm	MK MT		Artikel-Nr. Part-No.
25,0	327	206	3	1	1455 03 02500
25,5	335	214	3	1	1455 03 02550
26,0	335	214	3	1	1455 03 02600
26,5	335	214	3	1	1455 03 02650
27,0	343	222	3	1	1455 03 02700
27,5	343	222	3	1	1455 03 02750
28,0	343	222	3	1	1455 03 02800
28,5	351	230	3	1	1455 03 02850
29,0	351	230	3	1	1455 03 02900
29,5	351	230	3	1	1455 03 02950
30,0	351	230	3	1	1455 03 03000
32,0	397	248	4	1	1455 03 03200
33,0	397	248	4	1	1455 03 03300
34,0	397	248	4	1	1455 03 03400
35,0	406	257	4	1	1455 03 03500
36,0	416	267	4	1	1455 03 03600
37,0	416	267	4	1	1455 03 03700
38,0	426	277	4	1	1455 03 03800
39,0	426	277	4	1	1455 03 03900
40,0	426	277	4	1	1455 03 04000
41,0	436	287	4	1	1455 03 04100
42,0	436	287	4	1	1455 03 04200
43,0	447	298	4	1	1455 03 04300
44,0	447	298	4	1	1455 03 04400
45,0	447	298	4	1	1455 03 04500
46,0	459	310	4	1	1455 03 04600
47,0	459	310	4	1	1455 03 04700
48,0	470	321	4	1	1455 03 04800
49,0	470	321	4	1	1455 03 04900
50,0	470	321	4	1	1455 03 05000



SPIRALBOHRER
TWIST DRILLS

Schweißpunktbohrer HSS-E (Co5) Spot weld drills HSS-E (Co5)



Code 1801



Code 1802 TiN



Code 1803 TiALN



Spezialbohrer mit 180° Anschliff und kurzer Spirale. Zum Ausbohren von Schweißpunkten.

Special drill with 180° point-angle and short flute. For drilling out welding spot.

Ø d mm	L 1 mm		TiN		TiALN
			Artikel-Nr. Part-No.	Artikel-Nr. Part-No.	Artikel-Nr. Part-No.
6	66	1	1801 03 00600	1802 03 00600	1803 03 00600
7	74	1	1801 03 00700	1802 03 00700	1803 03 00700
8	79	1	1801 03 00800	1802 03 00800	1803 03 00800
10	89	1	1801 03 01000	1802 03 01000	1803 03 01000

Schweißpunktbohrer HSS-E (Co5) für Spotle T 575 und Vario WS 90 Spot weld drills HSS-E (Co5) for Spotle T 575 and Vario WS 90



Code 1810



Code 1811 TiN



Code 1812 TiALN

Spezialbohrer mit 180° Anschliff und Spannfläche für Pneumatikmaschinen. Zum Ausbohren von Schweißpunkten.

Special drill with 180° point-angle and clamping surface for pneumatic machines. For drilling out welding spot.

Ø d mm	L 1 mm	Ausführung Version		TiN		TiALN
				Artikel-Nr. Part-No.	Artikel-Nr. Part-No.	Artikel-Nr. Part-No.
8	40	Spotle-Drill	1	1810 03 00840	1811 03 00840	1812 03 00840
8	44	Vario-Drill	1	1810 03 00844	1811 03 00844	1812 03 00844

HSS Schweißpunktfräser HSS spot weld milling cutters



Code 1805



Schweißpunktfräser zum Lösen von punktgeschweißten Blechen. Beidseitig schneidend und auswechselbar.

Designed for removal and milling of welding point. Changeable and usable on both sides.

Bezeichnung Description	Ø d mm	L1 mm		Artikel-Nr. Part-No.
HSS Schweißpunktfräser komplett / HSS Spot-Weld Milling Cutters complete	10,0	72	1	1805 15 00001
Fräskrone / Milling Crown HSS	10,0	-	5	1805 15 00002
Zentrierstift / Centering pin	2,5	-	5	1805 15 00003

VHM Schweißpunktbohrer mit 3 Schneiden Solid carbide spot weld drill with 3 cutting edges



Code 1807



Schweißpunktbohrer aus Vollhartmetall mit 3 Schneiden. Zum Ausbohren von Schweißpunkten in hochfesten Blechen bis 1.800 N/mm². Mit 3-Flächenschaft für optimale Kraftübertragung. Deutlich schneller und langlebiger als vergleichbare Produkte mit 2 Schneiden. Bitte Drehzahlempfehlung beachten!

Mit TiALN-Beschichtung für eine höhere Standzeit.

Spot weld drill made of solid carbide with 3 cutting edges. For drilling out welding points in high-strength sheets up to 1.800 N/mm² (~ 52 HRC). With triangle-shank for optimum power transmission. Significantly faster and more durable than comparable products with 2 cutting edges. Please observe the recommended speed.

With TiALN-coating for a longer tool life.

Ø d mm	L 1 mm	U/min. rpm		Artikel-Nr. Part-No.
8	80	1800	1	1807 03 00800

VHM Schweißpunktbohrer mit 3 Schneiden für Vario WS 90 Solid carbide spot weld drill with 3 cutting edges for Vario WS 90

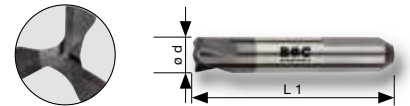

Code 1806

Schweißpunktbohrer aus Vollhartmetall mit 3 Schneiden und Spannfläche für Pneumatikmaschinen. Zum Ausbohren von Schweißpunkten in hochfesten Blechen bis 1.800 N/mm². Deutlich schneller und langlebiger als vergleichbare Produkte mit 2 Schneiden. Bitte Drehzahlempfehlung beachten!

Mit TiALN-Beschichtung für eine höhere Standzeit.

Spot weld drill made of solid carbide with 3 cutting edges and clamping surface for pneumatic machines. For drilling out welding points in high-strength sheets up to 1.800 N/mm² (~ 52 HRC). Significantly faster and more durable than comparable products with 2 cutting edges. Please observe the recommended speed.

With TiALN-coating for a longer tool life.





Ø d mm	L 1 mm	Ausführung Version	U/min. rpm		Artikel-Nr. Part-No.
8	45	Vario-Drill	1800	1	1806 03 00845

SCHWEISSPUNKTBOHRER
SPOT WELD DRILLS

HARTMETALL SPIRALBOHRER
CARBIDE TWIST DRILLS



HARTMETALL SPIRALBOHRER CARBIDE TWIST DRILLS

	DIN	Qualität Quality	Typ Type	Bezeichnung Description	Code	Seite Page
VHM Spiralbohrer / SC twist drills						
	338	VHM SC	N	VHM-Spiralbohrer TiALN-beschichtet Solid carbide drills TiALN-coated	1502	106 – 107
VHM Spiralbohrer extra kurz / SC twist drills extra short						
	6539	VHM SC	N	VHM-Spiralbohrer, extra kurz TiALN-beschichtet Solid carbide drills, extra short, TiALN-coated	1504	108 – 109
HM Spiralbohrer / TCT twist drills						
	8037	HSS HM HSS TCT	N	Spiralbohrer mit HM-Schneide Twist drills, carbide tipped	1500	110
VHM Schweißpunktbohrer / Solid carbide spot weld drills						
	BC Norm	VHM SC		VHM Schweißpunktbohrer mit 3 Schneiden, TiALN-beschichtet Solid carbide spot weld drill with 3 cutting edges, TiALN-coated	1807	111
	BC Norm	VHM SC		VHM Schweißpunktbohrer mit 3 Schneiden für Vario WS 90, TiALN-beschichtet Solid carbide spot weld drill with 3 cutting edges for Vario WS 90, TiALN-coated	1806	111

VHM Spiralbohrer DIN 338 Typ N, TiALN

Solid carbide twist drills DIN 338 type N, TiALN

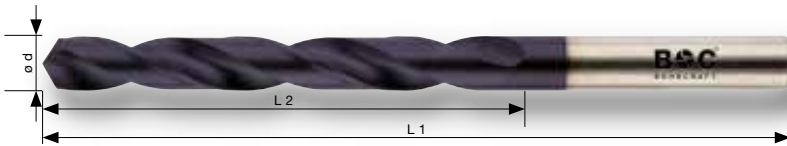

Code 1502



Code	P			M	K	N				S		H	
	1.1 - 2.1	3.1 - 4.1	5.1	1.1 - 4.1	1.1 - 4.2	1.1 - 1.6	2.1	2.2 - 2.3	2.7 - 2.8	4.2	1.1 - 1.3	2.1 - 2.6	1.1 - 1.5
1502	⊗	⊗	⊗	⊗	⊗	⊗	⊗	⊗	⊗	⊗	⊗	⊗	⊗

Stabiler Bohrer aus Vollhartmetall zum Bohren von hochfesten Stählen, Cr-Ni-Stählen, Hartguss, Grauguss, Stahlguss, Mn-Hartstahl, Bronze, Aluminium mit hohem Siliziumanteil und abrasiven Werkstoffen.

Mit TiALN-Beschichtung für eine höhere Standzeit.

Stable solid carbide twist drill for drilling heat resistant steels, high carbon steel castings, grey cast iron, cast steels, manganese steels, bronze, aluminium with high percentage of silicium and for machining abrasive materials.

With TiALN-coating for a longer tool life.

Ø d mm	L 1 mm	L 2 mm		Artikel-Nr. Part-No.	
1,0	34	12	1	1502 03 00100	○
1,1	36	14	1	1502 03 00110	○
1,2	38	16	1	1502 03 00120	○
1,3	38	16	1	1502 03 00130	○
1,4	40	18	1	1502 03 00140	○
1,5	40	18	1	1502 03 00150	○
1,6	43	20	1	1502 03 00160	○
1,7	43	20	1	1502 03 00170	○
1,8	46	23	1	1502 03 00180	○
1,9	46	23	1	1502 03 00190	○
2,0	49	24	1	1502 03 00200	●
2,1	49	24	1	1502 03 00210	○
2,2	53	27	1	1502 03 00220	○
2,3	53	27	1	1502 03 00230	○
2,4	57	30	1	1502 03 00240	○
2,5	57	30	1	1502 03 00250	●
2,6	57	30	1	1502 03 00260	○
2,7	61	33	1	1502 03 00270	○
2,8	61	33	1	1502 03 00280	○
2,9	61	33	1	1502 03 00290	○
3,0	61	33	1	1502 03 00300	●
3,1	65	36	1	1502 03 00310	○
3,2	65	36	1	1502 03 00320	○
3,3	65	36	1	1502 03 00330	○
3,4	70	39	1	1502 03 00340	○
3,5	70	39	1	1502 03 00350	●
3,6	70	39	1	1502 03 00360	○
3,7	70	39	1	1502 03 00370	○
3,8	70	43	1	1502 03 00380	○
3,9	75	43	1	1502 03 00390	○
4,0	75	43	1	1502 03 00400	●
4,1	75	43	1	1502 03 00410	●
4,2	75	43	1	1502 03 00420	●
4,3	80	47	1	1502 03 00430	○
4,4	80	47	1	1502 03 00440	○
4,5	80	47	1	1502 03 00450	●
4,6	80	47	1	1502 03 00460	○
4,7	80	47	1	1502 03 00470	○
4,8	86	52	1	1502 03 00480	○
4,9	86	52	1	1502 03 00490	○
5,0	86	52	1	1502 03 00500	●
5,1	86	52	1	1502 03 00510	○
5,2	86	52	1	1502 03 00520	○
5,3	86	52	1	1502 03 00530	○
5,4	93	57	1	1502 03 00540	○
5,5	93	57	1	1502 03 00550	●
5,6	93	57	1	1502 03 00560	○
5,7	93	57	1	1502 03 00570	○
5,8	93	57	1	1502 03 00580	○
5,9	93	57	1	1502 03 00590	○

HARTMETALL SPIRALBOHRER CARBIDE TWIST DRILLS

VHM Spiralbohrer DIN 338 Typ N, TiALN

Solid carbide twist drills DIN 338 type N, TiALN



Code 1502

Ø d mm	L 1 mm	L 2 mm		Artikel-Nr. Part-No.	
6,0	93	57	1	1502 03 00600	●
6,1	101	63	1	1502 03 00610	○
6,2	101	63	1	1502 03 00620	○
6,3	101	63	1	1502 03 00630	○
6,4	101	63	1	1502 03 00640	○
6,5	101	63	1	1502 03 00650	●
6,6	101	63	1	1502 03 00660	○
6,7	101	63	1	1502 03 00670	○
6,8	109	69	1	1502 03 00680	○
6,9	109	69	1	1502 03 00690	○
7,0	109	69	1	1502 03 00700	●
7,1	109	69	1	1502 03 00710	○
7,2	109	69	1	1502 03 00720	○
7,3	109	69	1	1502 03 00730	○
7,4	109	69	1	1502 03 00740	○
7,5	109	69	1	1502 03 00750	●
7,6	117	75	1	1502 03 00760	○
7,7	117	75	1	1502 03 00770	○
7,8	117	75	1	1502 03 00780	○
7,9	117	75	1	1502 03 00790	○
8,0	117	75	1	1502 03 00800	●
8,1	117	75	1	1502 03 00810	○
8,2	117	75	1	1502 03 00820	○
8,3	117	75	1	1502 03 00830	○
8,4	117	75	1	1502 03 00840	○
8,5	117	75	1	1502 03 00850	●
8,6	125	81	1	1502 03 00860	○
8,7	125	81	1	1502 03 00870	○
8,8	125	81	1	1502 03 00880	○
8,9	125	81	1	1502 03 00890	○
9,0	125	81	1	1502 03 00900	●
9,1	125	81	1	1502 03 00910	○
9,2	125	81	1	1502 03 00920	○
9,3	125	81	1	1502 03 00930	○
9,4	125	81	1	1502 03 00940	○
9,5	125	81	1	1502 03 00950	●
9,6	133	87	1	1502 03 00960	○
9,7	133	87	1	1502 03 00970	○
9,8	133	87	1	1502 03 00980	○
9,9	133	87	1	1502 03 00990	○
10,0	133	87	1	1502 03 01000	●
10,2	133	87	1	1502 03 01020	○
10,5	133	87	1	1502 03 01050	●
11,0	142	94	1	1502 03 01100	●
11,5	142	94	1	1502 03 01150	●
12,0	151	101	1	1502 03 01200	●
13,0	151	101	1	1502 03 01300	●

● ab Lager / ex stock ○ Lieferzeit 10 – 14 Tage / Delivery time 10 – 14 days

BC Multi-Pack / BC Multi-Pack

Bezeichnung Description	Teile Pieces	Inhalt Content	Artikel-Nr. Part-No.	
VHM 5 TiALN	5	Ø 4 · 5 · 6 · 8 · 10 mm	1502 13 30005	●



HARTMETALL SPIRALBOHRER
CARBIDE TWIST DRILLS

VHM Spiralbohrer DIN 6539 Typ N, TiALN

Solid carbide twist drills DIN 6539 type N, TiALN

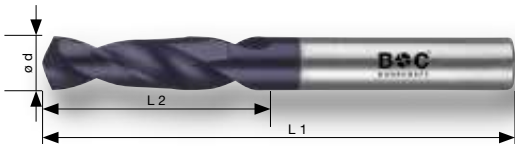

Code 1504 TiALN



Code	P			M	K	N				S		H	
	1.1 - 2.1	3.1 - 4.1	5.1	1.1 - 4.1	1.1 - 4.2	1.1 - 1.6	2.1	2.2 - 2.3	2.7 - 2.8	4.2	1.1 - 1.3	2.1 - 2.6	1.1 - 1.5
1504	⊗	⊗	⊗	⊗	⊗	⊗	⊗	⊗	⊗	⊗	⊗	⊗	⊗

Stabiler Bohrer aus Vollhartmetall zum Bohren von hochfesten Stählen, Cr-Ni-Stählen, Hartguss, Grauguss, Stahlguss, Mn-Hartstahl, Bronze, Aluminium mit hohem Siliziumanteil und abrasiven Werkstoffen.

Mit TiALN-Beschichtung für eine höhere Standzeit.

Stable solid carbide twist drill for drilling heat resistant steels, high carbon steel castings, grey cast iron, cast steels, manganese steels, bronze, aluminium with high percentage of silicium and for machining abrasive materials.

With TiALN-coating for a longer tool life.

Ø d mm	L 1 mm	L 2 mm		Artikel-Nr. Part-No.	
1,0	26	6	1	1504 03 00100	○
1,1	28	7	1	1504 03 00110	○
1,2	30	8	1	1504 03 00120	○
1,3	30	8	1	1504 03 00130	○
1,4	32	9	1	1504 03 00140	○
1,5	32	9	1	1504 03 00150	○
1,6	34	10	1	1504 03 00160	○
1,7	34	10	1	1504 03 00170	○
1,8	36	11	1	1504 03 00180	○
1,9	36	11	1	1504 03 00190	○
2,0	38	12	1	1504 03 00200	●
2,1	38	12	1	1504 03 00210	○
2,2	40	13	1	1504 03 00220	○
2,3	40	13	1	1504 03 00230	○
2,4	43	14	1	1504 03 00240	○
2,5	43	14	1	1504 03 00250	○
2,6	43	14	1	1504 03 00260	○
2,7	46	16	1	1504 03 00270	○
2,8	46	16	1	1504 03 00280	○
2,9	46	16	1	1504 03 00290	○
3,0	46	16	1	1504 03 00300	●
3,1	49	18	1	1504 03 00310	○
3,2	49	18	1	1504 03 00320	○
3,3	49	18	1	1504 03 00330	○
3,4	52	20	1	1504 03 00340	○
3,5	52	20	1	1504 03 00350	●
3,6	52	20	1	1504 03 00360	○
3,7	52	20	1	1504 03 00370	○
3,8	55	22	1	1504 03 00380	○
3,9	55	22	1	1504 03 00390	○
4,0	55	22	1	1504 03 00400	●
4,1	55	22	1	1504 03 00410	●
4,2	55	22	1	1504 03 00420	●
4,3	58	24	1	1504 03 00430	○
4,4	58	24	1	1504 03 00440	○
4,5	58	24	1	1504 03 00450	●
4,6	58	24	1	1504 03 00460	○
4,7	58	24	1	1504 03 00470	○
4,8	62	26	1	1504 03 00480	○
4,9	62	26	1	1504 03 00490	○
5,0	62	26	1	1504 03 00500	●
5,1	62	26	1	1504 03 00510	○
5,2	62	26	1	1504 03 00520	○
5,3	62	26	1	1504 03 00530	○
5,4	66	28	1	1504 03 00540	○
5,5	66	28	1	1504 03 00550	●
5,6	66	28	1	1504 03 00560	○
5,7	66	28	1	1504 03 00570	○
5,8	66	28	1	1504 03 00580	○
5,9	66	28	1	1504 03 00590	○

HARTMETALL SPIRALBOHRER CARBIDE TWIST DRILLS

VHM Spiralbohrer DIN 6539 Typ N, TiALN
Solid carbide twist drills DIN 6539 type N, TiALN

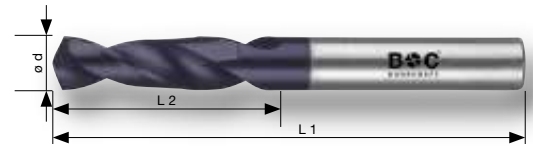

Code 1504 TiALN

Ø d mm	L 1 mm	L 2 mm		Artikel-Nr. Part-No.	
6,0	66	28	1	1504 03 00600	•
6,1	70	31	1	1504 03 00610	○
6,2	70	31	1	1504 03 00620	○
6,3	70	31	1	1504 03 00630	○
6,4	70	31	1	1504 03 00640	○
6,5	70	31	1	1504 03 00650	•
6,6	70	31	1	1504 03 00660	○
6,7	70	31	1	1504 03 00670	○
6,8	74	34	1	1504 03 00680	○
6,9	74	34	1	1504 03 00690	○
7,0	74	34	1	1504 03 00700	•
7,1	74	34	1	1504 03 00710	○
7,2	74	34	1	1504 03 00720	○
7,3	74	34	1	1504 03 00730	○
7,4	74	34	1	1504 03 00740	○
7,5	74	34	1	1504 03 00750	•
7,6	79	37	1	1504 03 00760	○
7,7	79	37	1	1504 03 00770	○
7,8	79	37	1	1504 03 00780	○
7,9	79	37	1	1504 03 00790	○
8,0	79	37	1	1504 03 00800	•
8,1	79	37	1	1504 03 00810	○
8,2	79	37	1	1504 03 00820	○
8,3	79	37	1	1504 03 00830	○
8,4	79	37	1	1504 03 00840	○
8,5	79	37	1	1504 03 00850	•
8,6	84	40	1	1504 03 00860	○
8,7	84	40	1	1504 03 00870	○
8,8	84	40	1	1504 03 00880	○
8,9	84	40	1	1504 03 00890	○
9,0	84	40	1	1504 03 00900	•
9,1	84	40	1	1504 03 00910	○
9,2	84	40	1	1504 03 00920	○
9,3	84	40	1	1504 03 00930	○
9,4	84	40	1	1504 03 00940	○
9,5	84	40	1	1504 03 00950	•
9,6	89	43	1	1504 03 00960	○
9,7	89	43	1	1504 03 00970	○
9,8	89	43	1	1504 03 00980	○
9,9	89	43	1	1504 03 00990	○
10,0	89	43	1	1504 03 01000	•
10,2	89	43	1	1504 03 01020	○
10,5	89	43	1	1504 03 01050	○
11,0	95	47	1	1504 03 01100	•
11,5	95	47	1	1504 03 01150	○
12,0	102	51	1	1504 03 01200	•
12,5	102	51	1	1504 03 01250	○
13,0	102	51	1	1504 03 01300	•
14,0	107	54	1	1504 03 01400	○
15,0	111	56	1	1504 03 01500	○
16,0	115	58	1	1504 03 01600	○

• ab Lager / ex stock ○ Lieferzeit 10 – 14 Tage / Delivery time 10 – 14 days

BC Multi-Pack / BC Multi-Pack

Bezeichnung Description	Teile Pieces	Inhalt Content	Artikel-Nr. Part-No.	
VHM 5-2 TiALN	5	Ø 4 · 5 · 6 · 8 · 10 mm	1504 13 30005	•



HARTMETALL SPIRALBOHRER
CARBIDE TWIST DRILLS

Spiralbohrer DIN 8037 HSS, mit HM-Schneiden

Twist drills DIN 8037 HSS, carbide tipped

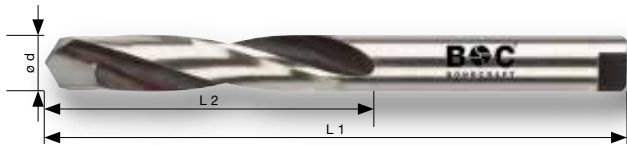

Code 1500



Code	P			M	K	N		S	
	1.1 - 2.1	3.1 - 4.1	5.1	1.1 - 2.1	1.1 - 4.2	1.1 - 1.6	2.1 - 2.6	4.2	1.1 - 1.3
1500									

Spiralbohrer mit eingelöteter HM-Schneidplatte, für Stahl und Stahlguss, Federbandstahl, Hartguss mit über 300 HB, zähnharte Bronzen, Reinmolybdän.

Carbide tipped twist drill for steel and cast iron, spring strip steel, chilled castings over 300 HB, ductile bronze and pure molybdenum.

Ø d mm	L 1 mm	L 2 mm		Artikel-Nr. Part-No.
2,5	46	17	1	1500 07 00250
3,0	50	20	1	1500 07 00300
3,5	56	25	1	1500 07 00350
4,0	56	25	1	1500 07 00400
4,2	63	28	1	1500 07 00420
4,5	63	28	1	1500 07 00450
5,0	63	28	1	1500 07 00500
5,5	71	32	1	1500 07 00550
6,0	71	32	1	1500 07 00600
6,5	71	32	1	1500 07 00650
6,8	80	40	1	1500 07 00680
7,0	80	40	1	1500 07 00700
7,5	80	40	1	1500 07 00750
8,0	80	40	1	1500 07 00800
8,5	90	50	1	1500 07 00850
9,0	90	50	1	1500 07 00900
9,5	90	50	1	1500 07 00950
10,0	100	56	1	1500 07 01000
10,2	100	56	1	1500 07 01020
10,5	100	56	1	1500 07 01050
11,0	100	56	1	1500 07 01100
11,5	112	63	1	1500 07 01150
12,0	112	63	1	1500 07 01200
12,5	112	63	1	1500 07 01250
13,0	112	63	1	1500 07 01300

BC Multi-Pack / BC Multi-Pack

Bezeichnung Description	Teile Pieces	Inhalt Content	Artikel-Nr. Part-No.
HM 5	5	Ø 4 · 5 · 6 · 8 · 10 mm	1500 13 30005



HM 5

HARTMETALL SPIRALBOHRER CARBIDE TWIST DRILLS

VHM Schweißpunktbohrer mit 3 Schneiden Solid carbide spot weld drill with 3 cutting edges



Code 1807



Schweißpunktbohrer aus Vollhartmetall mit 3 Schneiden. Zum Ausbohren von Schweißpunkten in hochfesten Blechen bis 1.800 N/mm². Mit 3-Flächenschaft für optimale Kraftübertragung. Deutlich schneller und langlebiger als vergleichbare Produkte mit 2 Schneiden. Bitte Drehzahlempfehlung beachten!

Mit TiALN-Beschichtung für eine höhere Standzeit.

Spot weld drill made of solid carbide with 3 cutting edges. For drilling out welding points in high-strength sheets up to 1.800 N/mm² (~ 52 HRC). With triangle-shank for optimum power transmission. Significantly faster and more durable than comparable products with 2 cutting edges. Please observe the recommended speed.

With TiALN-coating for a longer tool life.

Ø d mm	L 1 mm	U/min. rpm		Artikel-Nr. Part-No.
8	80	1800	1	1807 03 00800

VHM Schweißpunktbohrer mit 3 Schneiden für Vario WS 90 Solid carbide spot weld drill with 3 cutting edges for Vario WS 90

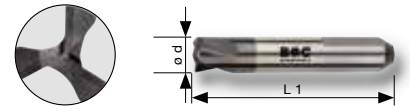

Code 1806

Schweißpunktbohrer aus Vollhartmetall mit 3 Schneiden und Spannfläche für Pneumatikmaschinen. Zum Ausbohren von Schweißpunkten in hochfesten Blechen bis 1.800 N/mm². Deutlich schneller und langlebiger als vergleichbare Produkte mit 2 Schneiden. Bitte Drehzahlempfehlung beachten!

Mit TiALN-Beschichtung für eine höhere Standzeit.

Spot weld drill made of solid carbide with 3 cutting edges and clamping surface for pneumatic machines. For drilling out welding points in high-strength sheets up to 1.800 N/mm² (~ 52 HRC). Significantly faster and more durable than comparable products with 2 cutting edges. Please observe the recommended speed.





















With TiALN-coating for a longer tool life.

Ø d mm	L 1 mm	Ausführung Version	U/min. rpm		Artikel-Nr. Part-No.
8	45	Vario-Drill	1800	1	1806 03 00845

SCHAFTFRÄSER HSS-E · HSS-E PM
END MILLS HSS-E · HSS-E PM









SCHAFTFRÄSER HSS-E END MILLS HSS-E

	DIN	Qualität Quality	Typ Type	Version	Schneiden Flutes	Schaft Shank	Bezeichnung Description	Code	Seite Page
		HSS-E Co5	W	kurz short	1	DIN 1835 A	Einzahnfräser Single fluted end mills	5345	118
		HSS-E Co5	W	lang long	1	DIN 1835 A	Einzahnfräser Single fluted end mills	5350	119
	844	HSS-E Co8	W	kurz short	2	DIN 1835 B	Langlochfräser Slot end mills	5355	120
	844	HSS-E Co8	W	kurz short	3	DIN 1835 B	Bohrnutenfräser Slot end mills	5365	121
	327	HSS-E Co8	N	kurz short	2	DIN 1835 B	Langlochfräser Slot end mills	5300	122 – 123
	327	HSS-E Co8	N	kurz short	2	DIN 1835 B	Langlochfräser, TiALN Slot end mills, TiALN	5301	122 – 123
		HSS-E Co8	N	lang long	2	DIN 1835 B	Langlochfräser Slot end mills	5305	124
		HSS-E Co8	N	lang long	2	DIN 1835 B	Langlochfräser, TiALN Slot end mills, TiALN	5306	124
	327	HSS-E Co8	N	kurz short	3	DIN 1835 B	Bohrnutenfräser Slot end mills	5310	125
	327	HSS-E Co8	N	kurz short	3	DIN 1835 B	Bohrnutenfräser, TiALN Slot end mills, TiALN	5311	125
	844	HSS-E Co8	NR	kurz short	4 – 6	DIN 1835 B	Schrupfräser Roughing end mills	5325	126
	844	HSS-E Co8	NR	kurz short	4 – 6	DIN 1835 B	Schrupfräser, TiALN Roughing end mills, TiALN	5326	126
	844	HSS-E Co8	NR	lang long	4 – 6	DIN 1835 B	Schrupfräser Roughing end mills	5330	127
	844	HSS-E Co8	NR	lang long	4 – 6	DIN 1835 B	Schrupfräser, TiALN Roughing end mills, TiALN	5331	127
	844	HSS-E Co8	HR	kurz short	4 – 6	DIN 1835 B	Schrupfräser Roughing end mills	5335	128
	844	HSS-E Co8	HR	kurz short	4 – 6	DIN 1835 B	Schrupfräser, TiALN Roughing end mills, TiALN	5336	128
	844	HSS-E Co8	N	kurz short	4 – 6	DIN 1835 B	Schaftfräser Finishing end mills	5315	129
	844	HSS-E Co8	N	kurz short	4 – 6	DIN 1835 B	Schaftfräser, TiALN Finishing end mills, TiALN	5316	129
	844	HSS-E Co8	N	lang long	4 – 6	DIN 1835 B	Schaftfräser Finishing end mills	5320	130
	844	HSS-E Co8	N	lang long	4 – 6	DIN 1835 B	Schaftfräser, TiALN Finishing end mills, TiALN	5321	130

SCHAFTFRÄSER HSS-E PM

END MILLS HSS-E PM

	DIN	Qualität Quality	Typ Type	Version	Schneiden Flutes	Schaft Shank	Bezeichnung Description	Code	Seite Page
Schaftfräser HSS-E PM / End mills HSS-E PM									
		844	HSS-E PM	HR	kurz short	4 – 5	DIN 1835 B Schruppfräser, AITiN Roughing end mills, AITiN	5435	131
		844	HSS-E PM	N	kurz short	4 – 5	DIN 1835 B Schaftfräser, AITiN Finishing end mills, AITiN	5415	132
		844	HSS-E PM	N	lang long	4 – 5	DIN 1835 B Schaftfräser, AITiN Finishing end mills, AITiN	5420	133

Anwendungsempfehlung für Schafffräser Application recommendation for end mills

DIN	-	-	844	844	327	327	-	-	327
Typ Type	W	W	W	W	N	N	N	N	N
Schneidstoff Cutting material	HSS-E Co5	HSS-E Co5	HSS-E Co8	HSS-E Co8	HSS-E Co8	HSS-E Co8	HSS-E Co8	HSS-E Co8	HSS-E Co8
Beschichtung Coating	-	-	-	-	-	TiALN	-	TiALN	-
Schneiden Cutting edges	1	1	2	3	2	2	2	2	3
Bereich Range	3 – 10 mm	5 – 8 mm	2 – 20 mm	2 – 20 mm	1 – 40 mm	1 – 40 mm	2 – 40 mm	2 – 40 mm	2 – 32 mm
Qualität Quality	★★★★★	★★★★★	★★★★★	★★★★★	★★★★★	★★★★★	★★★★★	★★★★★	★★★★★
Code	5345	5350	5355	5365	5300	5301	5305	5306	5310
Seite Page	118	119	120	121	122 – 123	122 – 123	124	124	125
P	1		☉	☉	☉	☉	☉	☉	☉
	2				☉	☉	☉	☉	☉
	3				☉	☉	☉	☉	☉
	4				☉	☉	☉	☉	☉
	5				☉	☉	☉	☉	☉
M	1				☉	☉	☉	☉	☉
	2				☉	☉	☉	☉	☉
	3								
K	1 – 2				☉	☉	☉	☉	☉
	4				☉	☉	☉	☉	☉
N	1.1 – 1.3	☉	☉	☉	☉				
	1.4 – 1.5	☉	☉	☉	☉		☉	☉	☉
	1.6								
	2.1 – 2.6								☉
S	1								
	2								

☉ geeignet / suitable ☉ bedingt geeignet / limited suitable



TECHNISCHE DETAILS
TECHNICAL DETAILS

Anwendungsempfehlung für Schaftfräser

Application recommendation for end mills











































DIN	327	844	844	844	844	844	844	844	844
Typ Type	N	NR	NR	NR	NR	HR	HR	N	N
Schneidstoff Cutting material	HSS-E Co8	HSS-E Co8	HSS-E Co8	HSS-E Co8	HSS-E Co8	HSS-E Co8	HSS-E Co8	HSS-E Co8	HSS-E Co8
Beschichtung Coating	TiALN	-	TiALN	-	TiALN	-	TiALN	-	TiALN
Schneiden Cutting edges	3	2	2	4 – 6	4 – 6	4 – 6	4 – 6	4 – 6	4 – 6
Bereich Range	2 – 32 mm	6 – 40 mm	6 – 40 mm	6 – 40 mm	6 – 40 mm	6 – 32 mm	6 – 32 mm	2 – 40 mm	2 – 40 mm
Qualität Quality	★★★★★								
Code	5311	5325	5326	5330	5331	5335	5336	5315	5316
Seite Page	125	126	126	127	127	128	128	129	129
P	1								
	2								
	3								
	4								
	5								
M	1								
	2								
	3								
K	1 – 2								
	4								
N	1.1 – 1.3								
	1.4 – 1.5								
	1.6								
	2.1 – 2.6								
S	1								
	2								

geeignet / suitable bedingt geeignet / limited suitable



TECHNISCHE DETAILS
TECHNICAL DETAILS

Anwendungsempfehlung für Schafffräser Application recommendation for end mills

				
844	844	844	844	844
N	N	HR	N	N
HSS-E Co8	HSS-E Co8	HSS-E PM	HSS-E PM	HSS-E PM
-	TiALN	AlTiN	AlTiN	AlTiN
4 – 6	4 – 6	4 – 5	4 – 5	4 – 6
2 – 40 mm	2 – 40 mm	6 – 30 mm	2 – 30 mm	3 – 32 mm
★★★★★	★★★★★	★★★★★	★★★★★	★★★★★
5320	5321	5435	5415	5420
130	130	131	132	133
				
				
				
				
				
				
				
				
				

 geeignet / suitable  bedingt geeignet / limited suitable



TECHNISCHE DETAILS
TECHNICAL DETAILS

Einzahnfräser HSS-E (Co5), kurz, Typ W

Single fluted end mills HSS-E (Co5), short, type W



Code 5345



Code	P					M			K		N				S	
	1	2	3	4	5	1	2	3	1-2	4	1.1-1.3	1.4-1.5	1.6	2.1-2.6	1	2
5345											☉	☉				

- 1 Schneide
- Zentrumschnitt
- Zum Fräsen, Einstechen und Konturfräsen.
- Speziell für die Bearbeitung von weichen Werkstoffen wie Aluminium, NE-Metallen und Kunststoffen.

- 1 cutting edge
- Centre cutting
- For milling, grooving and contour milling.
- Especially for machining soft materials such as aluminum, non-ferrous metals and plastics.

Ø d1 mm	L 1 mm	L 2 mm	Ø d2 / h6 mm	Z		Artikel-Nr. Part-No.	
3	60	10	8	1	1	5345 03 00300	•
4	60	12	8	1	1	5345 03 00400	•
5	60	14	8	1	1	5345 03 00500	•
6	60	14	8	1	1	5345 03 00600	•
7	60	14	8	1	1	5345 03 00700	•
8	80	14	8	1	1	5345 03 00800	•
10	80	14	8	1	1	5345 03 01000	•

• ab Lager / ex stock ◦ Lieferzeit 10 – 14 Tage / Delivery time 10 – 14 days

BC Boxen / BC Boxes

Bezeichnung Description	Teile Pieces	Inhalt Content	Artikel-Nr. Part-No.	
EZ 6	6	Ø 3 · 4 · 5 · 6 · 8 · 10 mm	5345 13 30006	•



SCHAFTFRÄSER HSS-E
END MILLS HSS-E

Einzahnfräser HSS-E (Co5), lange Ausführung, Typ W Single fluted end mills HSS-E (Co5), long version, type W

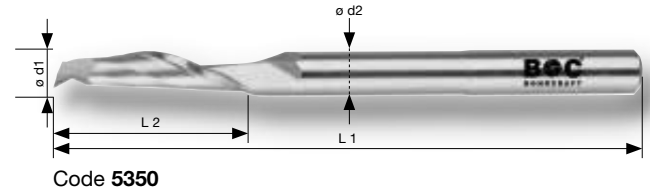

Code	P					M			K		N				S	
	1	2	3	4	5	1	2	3	1-2	4	1.1-1.3	1.4-1.5	1.6	2.1-2.6	1	2
5350											☉	☉				

- 1 Schneide
- Zentrumschnitt
- Zum Fräsen, Einstechen und Konturfräsen.
- Speziell für die Bearbeitung von weichen Werkstoffen wie Aluminium, NE-Metallen und Kunststoffen.

- 1 cutting edge
- Centre cutting
- For milling, grooving and contour milling.
- Especially for machining soft materials such as aluminum, non-ferrous metals and plastics.

Ø d1 mm	L 1 mm	L 2 mm	Ø d2 / h6 mm	Z		Artikel-Nr. Part-No.	
5	80	14	8	1	1	5350 03 00500	•
6	80	14	8	1	1	5350 03 00600	•
8	100	30	8	1	1	5350 03 00800	•

• ab Lager / ex stock ◦ Lieferzeit 10 – 14 Tage / Delivery time 10 – 14 days



SCHAFTFRÄSER HSS-E
END MILLS HSS-E

Langlochfräser DIN 844 HSS-E (Co8), kurz, 2 Schneiden, Typ W
Slot end mills DIN 844 HSS-E M42 (Co8), short, 2 cutting edges, type W

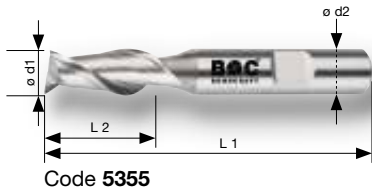

Code 5355



Code	P					M			K		N				S	
	1	2	3	4	5	1	2	3	1-2	4	1.1-1.3	1.4-1.5	1.6	2.1-2.6	1	2
5355	☉										☉	☉				

- 2 Schneiden
- Zentrumschnitt
- Geeignet für Tauch-, Nut- und Passungsfräsen.
- Speziell für die Bearbeitung von weichen Werkstoffen wie Aluminium, NE-Metallen und Kunststoffen.

- 2 cutting edges
- Centre cutting
- Suitable for plunge, slot and fitting milling.
- Especially for machining soft materials such as aluminum, non-ferrous metals and plastics.

Ø d1 mm	L 1 mm	L 2 mm	Ø d2 / h6 mm	Z		Artikel-Nr. Part-No.	
2,0	51	7	6	2	1	5355 03 00200	•
3,0	52	8	6	2	1	5355 03 00300	•
4,0	55	11	6	2	1	5355 03 00400	•
4,5	55	11	6	2	1	5355 03 00450	○
5,0	57	13	6	2	1	5355 03 00500	•
6,0	57	13	6	2	1	5355 03 00600	•
7,0	66	16	10	2	1	5355 03 00700	○
8,0	69	19	10	2	1	5355 03 00800	•
9,0	69	19	10	2	1	5355 03 00900	○
10,0	72	22	10	2	1	5355 03 01000	○
12,0	83	26	12	2	1	5355 03 01200	•
14,0	83	26	12	2	1	5355 03 01400	•
15,0	83	26	12	2	1	5355 03 01500	○
16,0	92	32	16	2	1	5355 03 01600	•
18,0	92	32	16	2	1	5355 03 01800	○
20,0	104	38	20	2	1	5355 03 02000	•

• ab Lager / ex stock ○ Lieferzeit 10 – 14 Tage / Delivery time 10 – 14 days



SCHAFTFRÄSER HSS-E
END MILLS HSS-E

Bohrnutenfräser DIN 844 HSS-E (Co8), kurz, 3 Schneiden, Typ W
Slot end mills DIN 844 HSS-E M42 (Co8), short, 3 cutting edges, type W

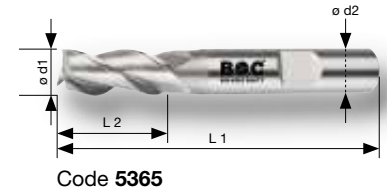

Code	P					M			K		N				S	
	1	2	3	4	5	1	2	3	1-2	4	1.1-1.3	1.4-1.5	1.6	2.1-2.6	1	2
5365	⊕										⊕	⊕				

- 3 Schneiden
- Zentrumschnitt
- Geeignet für Tauch-, Nut- und Passungsfräsen.
- Speziell für die Bearbeitung von weichen Werkstoffen wie Aluminium, NE-Metallen und Kunststoffen.
- 3 cutting edges
- Centre cutting
- Suitable for plunge, slot and fitting milling.
- Especially for machining soft materials such as aluminum, non-ferrous metals and plastics.

Ø d1 mm	L 1 mm	L 2 mm	Ø d2 / h6 mm	Z		Artikel-Nr. Part-No.	
2,0	51	7	6	3	1	5365 03 00200	•
3,0	52	8	6	3	1	5365 03 00300	•
4,0	55	11	6	3	1	5365 03 00400	•
4,5	55	11	6	3	1	5365 03 00450	○
5,0	57	13	6	3	1	5365 03 00500	•
6,0	57	13	6	3	1	5365 03 00600	•
7,0	66	16	10	3	1	5365 03 00700	○
8,0	69	19	10	3	1	5365 03 00800	•
9,0	69	19	10	3	1	5365 03 00900	○
10,0	72	22	10	3	1	5365 03 01000	•
12,0	83	26	12	3	1	5365 03 01200	•
14,0	83	26	12	3	1	5365 03 01400	•
15,0	83	26	12	3	1	5365 03 01500	○
16,0	92	32	16	3	1	5365 03 01600	•
18,0	92	32	16	3	1	5365 03 01800	○
20,0	104	38	20	3	1	5365 03 02000	•

• ab Lager / ex stock ○ Lieferzeit 10 – 14 Tage / Delivery time 10 – 14 days



SCHAFTFRÄSER HSS-E
END MILLS HSS-E

Langlochfräser DIN 327 HSS-E (Co8), kurz, 2 Schneiden, Typ N Slot end mills DIN 327 HSS-E M42 (Co8), short, 2 cutting edges, type N



Code 5300



Code 5301



Code	P					M			K		N				S	
	1	2	3	4	5	1	2	3	1-2	4	1.1-1.3	1.4-1.5	1.6	2.1-2.6	1	2
5300 · 5301	●	●	●	●	●	●	●	●	●	●	●	●	●	●	●	●

- 2 Schneiden
- Zentrumschnitt
- Geeignet für Tauch-, Nut- und Passungsfräsen.
- 2 cutting edges
- Centre cutting
- Suitable for plunge, slot and fitting milling.

Ø d1 mm	L 1 mm	L 2 mm	Ø d2 / h6 mm	Z	🏠	TiALN		🏠
						Artikel-Nr. Part-No.	Artikel-Nr. Part-No.	
1,00	47	2,5	6	2	1	5300 03 00100	5301 03 00100	●
1,50	47	3,0	6	2	1	5300 03 00150	5301 03 00150	●
2,00	48	4,0	6	2	1	5300 03 00200	5301 03 00200	●
2,50	49	5,0	6	2	1	5300 03 00250	5301 03 00250	○
2,80	49	5,0	6	2	1	5300 03 00280	5301 03 00280	○
3,00	49	5,0	6	2	1	5300 03 00300	5301 03 00300	●
3,50	50	6,0	6	2	1	5300 03 00350	5301 03 00350	○
3,80	51	7,0	6	2	1	5300 03 00380	5301 03 00380	○
4,00	51	7,0	6	2	1	5300 03 00400	5301 03 00400	●
4,50	51	7,0	6	2	1	5300 03 00450	5301 03 00450	○
4,80	52	8,0	6	2	1	5300 03 00480	5301 03 00480	○
5,00	52	8,0	6	2	1	5300 03 00500	5301 03 00500	●
5,50	52	8,0	6	2	1	5300 03 00550	5301 03 00550	○
5,75	52	8,0	6	2	1	5300 03 00575	5301 03 00575	○
6,00	52	8,0	6	2	1	5300 03 00600	5301 03 00600	●
6,50	60	10,0	10	2	1	5300 03 00650	5301 03 00650	○
7,00	60	10,0	10	2	1	5300 03 00700	5301 03 00700	○
7,50	60	10,0	10	2	1	5300 03 00750	5301 03 00750	○
7,75	61	11,0	10	2	1	5300 03 00775	5301 03 00775	○
8,00	61	11,0	10	2	1	5300 03 00800	5301 03 00800	●
8,50	61	11,0	10	2	1	5300 03 00850	5301 03 00850	○
9,00	61	11,0	10	2	1	5300 03 00900	5301 03 00900	●
9,50	61	11,0	10	2	1	5300 03 00950	5301 03 00950	○
9,70	63	13,0	10	2	1	5300 03 00970	5301 03 00970	○
10,00	63	13,0	10	2	1	5300 03 01000	5301 03 01000	●
10,50	70	13,0	12	2	1	5300 03 01050	5301 03 01050	○
11,00	70	13,0	12	2	1	5300 03 01100	5301 03 01100	●
11,50	70	13,0	12	2	1	5300 03 01150	5301 03 01150	○
12,00	73	16,0	12	2	1	5300 03 01200	5301 03 01200	●
12,50	73	16,0	12	2	1	5300 03 01250	5301 03 01250	○
13,00	73	16,0	12	2	1	5300 03 01300	5301 03 01300	●
13,50	73	16,0	12	2	1	5300 03 01350	5301 03 01350	○
14,00	73	16,0	12	2	1	5300 03 01400	5301 03 01400	●
15,00	73	16,0	12	2	1	5300 03 01500	5301 03 01500	●
16,00	79	19,0	16	2	1	5300 03 01600	5301 03 01600	●
17,00	79	19,0	16	2	1	5300 03 01700	5301 03 01700	○
18,00	79	19,0	16	2	1	5300 03 01800	5301 03 01800	●
19,00	79	19,0	16	2	1	5300 03 01900	5301 03 01900	○
20,00	88	22,0	20	2	1	5300 03 02000	5301 03 02000	●
21,00	88	22,0	20	2	1	5300 03 02100	5301 03 02100	○
22,00	88	22,0	20	2	1	5300 03 02200	5301 03 02200	○
24,00	102	26,0	25	2	1	5300 03 02400	5301 03 02400	○
25,00*	102	26,0	25	2	1	5300 03 02500	5301 03 02500	●
26,00	102	26,0	25	2	1	5300 03 02600	5301 03 02600	●
28,00*	102	26,0	25	2	1	5300 03 02800	5301 03 02800	●
30,00	102	26,0	25	2	1	5300 03 03000	5301 03 03000	●
32,00	112	32,0	32	2	1	5300 03 03200	5301 03 03200	●
36,00	112	32,0	32	2	1	5300 03 03600	5301 03 03600	●
40,00*	118	38,0	32	2	1	5300 03 04000	5301 03 04000	○

* ≠ DIN 327 ● ab Lager / ex stock ○ Lieferzeit 10 – 14 Tage / Delivery time 10 – 14 days

SCHAFTFRÄSER HSS-E
END MILLS HSS-E

Langlochfräser DIN 327 HSS-E (Co8), kurz, 2 Schneiden, Typ N
Slot end mills DIN 327 HSS-E M42 (Co8), short, 2 cutting edges, type N



Code 5300



Code 5301

BC Boxen / BC Boxes

Bezeichnung Description	Teile Pieces	Inhalt Content	Artikel-Nr. Part-No.	
LF 6	6	1x Ø 6 · 8 · 10 · 12 · 16 · 20 mm	5300 13 30006	•
LF 6-2	6	1x Ø 4 · 5 · 6 · 8 · 10 · 12 mm	5300 13 30007	•
LF 8	8	2x Ø 6 · 8 · 10 · 12 mm	5300 13 30008	•
LF 6 TiALN	6	1x Ø 6 · 8 · 10 · 12 · 16 · 20 mm	5301 13 30006	•
LF 6-2 TiALN	6	1x Ø 4 · 5 · 6 · 8 · 10 · 12 mm	5301 13 30007	•
LF 8 TiALN	8	2x Ø 6 · 8 · 10 · 12 mm	5301 13 30008	•



LF 6



LF 6-2



LF 8



LF 6 TiALN



LF 6-2 TiALN



SCHAFTFRÄSER HSS-E
END MILLS HSS-E

Langlochfräser HSS-E (Co8), lange Ausführung, 2 Schneiden, Typ N
Slot end mills HSS-E M42 (Co8), long version, 2 cutting edges, type N

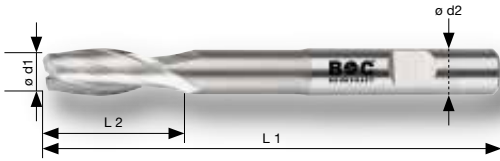

Code 5305



Code 5306



Code	P					M			K		N				S	
	1	2	3	4	5	1	2	3	1-2	4	1.1-1.3	1.4-1.5	1.6	2.1-2.6	1	2
5305 · 5306	●	●	●	●	●	●				●	●					

- 2 Schneiden
- Zentrumschnitt
- Geeignet für Tauch-, Nut- und Passungsfräsen.

- 2 cutting edges
- Centre cutting
- Suitable for plunge, slot and fitting milling.

Ø d1 mm	L 1 mm	L 2 mm	Ø d2 / h6 mm	Z	🏠	TiALN		🏠
						Artikel-Nr. Part-No.	Artikel-Nr. Part-No.	
2,0	54	7	6	2	1	5305 03 00200	5306 03 00200	○
3,0	56	8	6	2	1	5305 03 00300	5306 03 00300	○
3,5	59	10	6	2	1	5305 03 00350	5306 03 00350	○
4,0	63	11	6	2	1	5305 03 00400	5306 03 00400	○
4,5	63	11	6	2	1	5305 03 00450	5306 03 00450	○
5,0	68	13	6	2	1	5305 03 00500	5306 03 00500	○
5,5	68	13	6	2	1	5305 03 00550	5306 03 00550	○
6,0	68	13	6	2	1	5305 03 00600	5306 03 00600	○
6,5	80	16	10	2	1	5305 03 00650	5306 03 00650	○
7,0	80	16	10	2	1	5305 03 00700	5306 03 00700	○
8,0	88	19	10	2	1	5305 03 00800	5306 03 00800	○
8,5	88	19	10	2	1	5305 03 00850	5306 03 00850	○
9,0	88	19	10	2	1	5305 03 00900	5306 03 00900	○
10,0	95	22	10	2	1	5305 03 01000	5306 03 01000	○
11,0	102	22	12	2	1	5305 03 01100	5306 03 01100	○
12,0	110	26	12	2	1	5305 03 01200	5306 03 01200	○
13,0	110	26	12	2	1	5305 03 01300	5306 03 01300	○
14,0	110	26	12	2	1	5305 03 01400	5306 03 01400	○
15,0	110	26	12	2	1	5305 03 01500	5306 03 01500	○
16,0	123	32	16	2	1	5305 03 01600	5306 03 01600	○
18,0	123	32	16	2	1	5305 03 01800	5306 03 01800	○
20,0	141	38	20	2	1	5305 03 02000	5306 03 02000	○
22,0	141	38	20	2	1	5305 03 02200	5306 03 02200	○
24,0	166	45	25	2	1	5305 03 02400	5306 03 02400	○
25,0	166	45	25	2	1	5305 03 02500	5306 03 02500	○
26,0	166	45	25	2	1	5305 03 02600	5306 03 02600	○
28,0	166	45	25	2	1	5305 03 02800	5306 03 02800	○
30,0	166	45	25	2	1	5305 03 03000	5306 03 03000	○
32,0	186	53	32	2	1	5305 03 03200	5306 03 03200	○
36,0	186	53	32	2	1	5305 03 03600	5306 03 03600	○
40,0*	196	63	32	2	1	5305 03 04000	5306 03 04000	○

* ≠ ISO 1641 ● ab Lager / ex stock ○ Lieferzeit 10 – 14 Tage / Delivery time 10 – 14 days

SCHAFTFRÄSER HSS-E
END MILLS HSS-E

Bohrnutenfräser DIN 327 HSS-E (Co8), kurz, 3 Schneiden, Typ N Slot end mills DIN 327 HSS-E M42 (Co8), short, 3 cutting edges, type N



Code 5310



Code 5311



Code	P					M			K		N				S	
	1	2	3	4	5	1	2	3	1-2	4	1.1-1.3	1.4-1.5	1.6	2.1-2.6	1	2
5310 · 5311	⊙	⊙	⊙	⊙		⊙			⊙	⊙			⊙			

- 3 Schneiden
- Zentrumschnitt
- Geeignet für Tauch-, Nut- und Passungsfräsen.
- 3 cutting edges
- Centre cutting
- Suitable for plunge, slot and fitting milling.

Ø d1 mm	L 1 mm	L 2 mm	Ø d2 / h6 mm	Z	⏏	TiALN		🏠
						Artikel-Nr. Part-No.	Artikel-Nr. Part-No.	
3,0	49	5	6	3	1	5310 03 00300	5311 03 00300	⊙
3,5	50	6	6	3	1	5310 03 00350	5311 03 00350	⊙
4,0	51	7	6	3	1	5310 03 00400	5311 03 00400	⊙
4,5	51	7	6	3	1	5310 03 00450	5311 03 00450	⊙
5,0	52	8	6	3	1	5310 03 00500	5311 03 00500	⊙
5,5	52	8	6	3	1	5310 03 00550	5311 03 00550	⊙
6,0	52	8	6	3	1	5310 03 00600	5311 03 00600	⊙
6,5	60	10	10	3	1	5310 03 00650	5311 03 00650	⊙
7,0	60	10	10	3	1	5310 03 00700	5311 03 00700	⊙
7,5	60	10	10	3	1	5310 03 00750	5311 03 00750	⊙
8,0	61	11	10	3	1	5310 03 00800	5311 03 00800	⊙
9,0	61	11	10	3	1	5310 03 00900	5311 03 00900	⊙
9,5	61	11	10	3	1	5310 03 00950	5311 03 00950	⊙
10,0	63	13	10	3	1	5310 03 01000	5311 03 01000	⊙
11,0	70	13	12	3	1	5310 03 01100	5311 03 01100	⊙
12,0	73	16	12	3	1	5310 03 01200	5311 03 01200	⊙
13,0	73	16	12	3	1	5310 03 01300	5311 03 01300	⊙
14,0	73	16	12	3	1	5310 03 01400	5311 03 01400	⊙
15,0	73	16	12	3	1	5310 03 01500	5311 03 01500	⊙
16,0	73	19	16	3	1	5310 03 01600	5311 03 01600	⊙
18,0	79	19	16	3	1	5310 03 01800	5311 03 01800	⊙
20,0	88	22	20	3	1	5310 03 02000	5311 03 02000	⊙
22,0	88	22	20	3	1	5310 03 02200	5311 03 02200	⊙
25,0	102	26	25	3	1	5310 03 02500	5311 03 02500	⊙
28,0	102	26	25	3	1	5310 03 02800	5311 03 02800	⊙
30,0	102	26	25	3	1	5310 03 03000	5311 03 03000	⊙
32,0	112	32	32	3	1	5310 03 03200	5311 03 03200	⊙

• ab Lager / ex stock ⊙ Lieferzeit 10 – 14 Tage / Delivery time 10 – 14 days



SCHAFTFRÄSER HSS-E
END MILLS HSS-E

Schruppfräser DIN 844 HSS-E (Co8), kurz, Typ NR

Roughing end mills DIN 844 HSS-E M42 (Co8), short, type NR

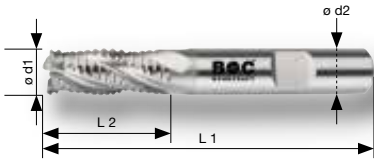

Code 5325



Code 5326



Code	P					M			K		N				S	
	1	2	3	4	5	1	2	3	1-2	4	1.1-1.3	1.4-1.5	1.6	2.1-2.6	1	2
5325 · 5326	●	●			●				●			●				

- 4 – 6 Schneiden
- Zentrumschnitt
- Schruppverzahnung
- Schruppfräser für den universellen Einsatz beim Tauch-, Nut- und Schlitzfräsen sowie Stirn- und Umfangfräsen.

- 4 – 6 cutting edges
- Centre cutting
- Roughing profile
- Roughing end mills for universal use in plunge, slot milling as well as face and peripheral milling.

Ø d1 mm	L 1 mm	L 2 mm	Ø d2 / h6 mm	Z	🏠	TiAlN		🏠
						Artikel-Nr. Part-No.	Artikel-Nr. Part-No.	
6	57	13	6	4	1	5325 03 00600	5326 03 00600	●
7	66	16	10	4	1	5325 03 00700	5326 03 00700	●
8	69	19	10	4	1	5325 03 00800	5326 03 00800	●
9	69	19	10	4	1	5325 03 00900	5326 03 00900	○
10	72	22	10	4	1	5325 03 01000	5326 03 01000	●
11	79	22	12	4	1	5325 03 01100	5326 03 01100	○
12	83	26	12	4	1	5325 03 01200	5326 03 01200	●
13	83	26	12	4	1	5325 03 01300	5326 03 01300	○
14	83	26	12	4	1	5325 03 01400	5326 03 01400	●
15	83	26	12	4	1	5325 03 01500	5326 03 01500	○
16	92	32	16	4	1	5325 03 01600	5326 03 01600	●
17	92	32	16	4	1	5325 03 01700	5326 03 01700	●
18	92	32	16	4	1	5325 03 01800	5326 03 01800	●
19	92	32	16	4	1	5325 03 01900	5326 03 01900	○
20	104	38	20	4	1	5325 03 02000	5326 03 02000	●
21	104	38	20	4	1	5325 03 02100	5326 03 02100	○
22	104	38	20	5	1	5325 03 02200	5326 03 02200	○
24	121	45	25	5	1	5325 03 02400	5326 03 02400	○
25	121	45	25	5	1	5325 03 02500	5326 03 02500	○
26	121	45	25	5	1	5325 03 02600	5326 03 02600	○
28	121	45	25	5	1	5325 03 02800	5326 03 02800	○
30	121	45	25	5	1	5325 03 03000	5326 03 03000	○
32	133	53	32	6	1	5325 03 03200	5326 03 03200	○
36	133	53	32	6	1	5325 03 03600	5326 03 03600	○
40*	143	63	32	6	1	5325 03 04000	5326 03 04000	○

* ≠ DIN 844 ● ab Lager / ex stock ○ Lieferzeit 10 – 14 Tage / Delivery time 10 – 14 days

SCHAFTFRÄSER HSS-E
END MILLS HSS-E

Schrappfräser DIN 844 HSS-E (Co8), lange Ausführung, Typ NR
Roughing end mills DIN 844 HSS-E M42 (Co8), long version, type NR

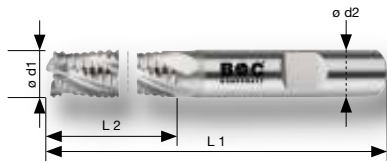

Code 5330



Code 5331



Code	P					M			K		N				S	
	1	2	3	4	5	1	2	3	1-2	4	1.1-1.3	1.4-1.5	1.6	2.1-2.6	1	2
5330 · 5331	●	●			●		●		●			●				

- 4 – 6 Schneiden
- Zentrumschnitt
- Schrappverzahnung
- Schrappfräser für den universellen Einsatz beim Tauch-, Nut- und Schlitzfräsen sowie Stirn- und Umfangfräsen.

- 4 – 6 cutting edges
- Centre cutting
- Roughing profile
- Roughing end mills for universal use in plunge, slot milling as well as face and peripheral milling.

Ø d1 mm	L 1 mm	L 2 mm	Ø d2 / h6 mm	Z	📏	TiALN		🏠
						Artikel-Nr. Part-No.	Artikel-Nr. Part-No.	
6	68	24	6	4	1	5330 03 00600	5331 03 00600	●
7	80	30	10	4	1	5330 03 00700	5331 03 00700	○
8	88	38	10	4	1	5330 03 00800	5331 03 00800	●
9	88	38	10	4	1	5330 03 00900	5331 03 00900	○
10	95	45	10	4	1	5330 03 01000	5331 03 01000	●
11	102	45	12	4	1	5330 03 01100	5331 03 01100	○
12	110	53	12	4	1	5330 03 01200	5331 03 01200	●
14	110	53	12	4	1	5330 03 01400	5331 03 01400	○
15	110	53	12	4	1	5330 03 01500	5331 03 01500	○
16	123	63	16	4	1	5330 03 01600	5331 03 01600	●
18	123	63	16	4	1	5330 03 01800	5331 03 01800	●
20	141	75	20	4	1	5330 03 02000	5331 03 02000	●
22	141	75	20	5	1	5330 03 02200	5331 03 02200	○
24	166	90	25	5	1	5330 03 02400	5331 03 02400	○
25	166	90	25	5	1	5330 03 02500	5331 03 02500	●
26	166	90	25	5	1	5330 03 02600	5331 03 02600	○
28	166	90	25	5	1	5330 03 02800	5331 03 02800	●
30	166	90	25	5	1	5330 03 03000	5331 03 03000	●
32	186	106	32	6	1	5330 03 03200	5331 03 03200	●
36	186	106	32	6	1	5330 03 03600	5331 03 03600	○
40*	205	125	32	6	1	5330 03 04000	5331 03 04000	○

* ≠ DIN 844 ● ab Lager / ex stock ○ Lieferzeit 10 – 14 Tage / Delivery time 10 – 14 days



SCHAFTFRÄSER HSS-E
END MILLS HSS-E

Schruppfräser DIN 844 HSS-E (Co8), kurz, Typ HR

Roughing end mills DIN 844 HSS-E M42 (Co8), short, type HR

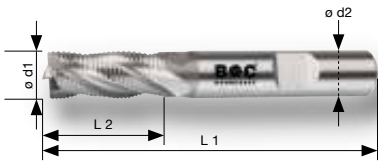

Code 5335



Code 5336



Code	P					M			K		N				S	
	1	2	3	4	5	1	2	3	1-2	4	1.1-1.3	1.4-1.5	1.6	2.1-2.6	1	2
5335 · 5336																

- 4 – 6 Schneiden
- Zentrumschnitt
- Feine Schruppverzahnung
- Schruppfräser für den Einsatz in Werkstoffen mit mittlerer und höherer Festigkeit bis 1.200 N/mm².
- Geeignet für Tauch-, Nut- und Schlitzfräsen sowie Stirn- und Umfangfräsen.

- 4 – 6 cutting edges
- Centre cutting
- Fine pitched roughing profile
- Roughing end mills for machining materials with medium and higher tensile strength up to 1.200 N/mm² (38 HRC).
- Suitable for plunge and slot milling as well as face and peripheral milling.

Ø d1 mm	L 1 mm	L 2 mm	Ø d2 / h6 mm	Z	Image Icon	TiALN		Image Icon
						Artikel-Nr. Part-No.	Artikel-Nr. Part-No.	
6	57	13	6	4	1	5335 03 00600	5336 03 00600	●
7	66	16	10	4	1	5335 03 00700	5336 03 00700	○
8	69	19	10	4	1	5335 03 00800	5336 03 00800	●
9	69	19	10	4	1	5335 03 00900	5336 03 00900	○
10	72	22	10	4	1	5335 03 01000	5336 03 01000	●
11	79	22	12	4	1	5335 03 01100	5336 03 01100	○
12	83	26	12	4	1	5335 03 01200	5336 03 01200	●
13	83	26	12	4	1	5335 03 01300	5336 03 01300	○
14	83	26	12	4	1	5335 03 01400	5336 03 01400	○
15	83	26	12	4	1	5335 03 01500	5336 03 01500	○
16	92	32	16	4	1	5335 03 01600	5336 03 01600	●
17	92	32	16	4	1	5335 03 01700	5336 03 01700	○
18	92	32	16	4	1	5335 03 01800	5336 03 01800	●
20	104	38	20	5	1	5335 03 02000	5336 03 02000	●
22	104	38	20	5	1	5335 03 02200	5336 03 02200	○
24	121	45	25	5	1	5335 03 02400	5336 03 02400	○
25	121	45	25	5	1	5335 03 02500	5336 03 02500	●
26	121	45	25	5	1	5335 03 02600	5336 03 02600	○
28	121	45	25	5	1	5335 03 02800	5336 03 02800	○
30	121	45	25	5	1	5335 03 03000	5336 03 03000	●
32	133	53	32	6	1	5335 03 03200	5336 03 03200	○

● ab Lager / ex stock ○ Lieferzeit 10 – 14 Tage / Delivery time 10 – 14 days

SCHAFTFRÄSER HSS-E
END MILLS HSS-E

Schaftfräser DIN 844 HSS-E (Co8), kurz, Typ N
Finishing end mills DIN 844 HSS-E M42 (Co8), short, type N



Code 5315



Code 5316



Code	P					M			K		N				S	
	1	2	3	4	5	1	2	3	1-2	4	1.1-1.3	1.4-1.5	1.6	2.1-2.6	1	2
5315 · 5316	●	●	●	●						●						●

- 3 – 6 Schneiden
- Zentrumschnitt
- Schlichtverzahnung
- Schaftfräser für den universellen Einsatz beim Tauch-, Nut- und Schlitzfräsen sowie Stirn- und Umfangfräsen.

- 3 – 6 cutting edges
- Centre cutting
- Finishing profile
- End mills for universal use in plunge, slot milling as well as face and peripheral milling.

Ø d1 mm	L 1 mm	L 2 mm	Ø d2 / h6 mm	Z	📏	TiALN		🏠
						Artikel-Nr. Part-No.	Artikel-Nr. Part-No.	
2,0	51	7	6	3	1	5315 03 00200	5316 03 00200	●
2,5	52	8	6	3	1	5315 03 00250	5316 03 00250	●
3,0	52	8	6	4	1	5315 03 00300	5316 03 00300	●
3,5	54	10	6	4	1	5315 03 00350	5316 03 00350	●
4,0	55	11	6	4	1	5315 03 00400	5316 03 00400	●
4,5	55	11	6	4	1	5315 03 00450	5316 03 00450	●
5,0	57	13	6	4	1	5315 03 00500	5316 03 00500	●
5,5	57	13	6	4	1	5315 03 00550	5316 03 00550	●
6,0	57	13	6	4	1	5315 03 00600	5316 03 00600	●
6,5	66	16	10	4	1	5315 03 00650	5316 03 00650	●
7,0	66	16	10	4	1	5315 03 00700	5316 03 00700	●
7,5	66	16	10	4	1	5315 03 00750	5316 03 00750	●
8,0	69	19	10	4	1	5315 03 00800	5316 03 00800	●
8,5	69	19	10	4	1	5315 03 00850	5316 03 00850	●
9,0	69	19	10	4	1	5315 03 00900	5316 03 00900	●
10,0	72	22	10	4	1	5315 03 01000	5316 03 01000	●
11,0	79	22	12	4	1	5315 03 01100	5316 03 01100	●
12,0	83	26	12	4	1	5315 03 01200	5316 03 01200	●
13,0	83	26	12	4	1	5315 03 01300	5316 03 01300	●
14,0	83	26	14	4	1	5315 03 01400	5316 03 01400	●
15,0	83	26	15	4	1	5315 03 01500	5316 03 01500	●
16,0	92	32	16	4	1	5315 03 01600	5316 03 01600	●
17,0	92	32	16	4	1	5315 03 01700	5316 03 01700	●
18,0	92	32	18	4	1	5315 03 01800	5316 03 01800	●
20,0	104	38	20	4	1	5315 03 02000	5316 03 02000	●
22,0	104	38	20	5	1	5315 03 02200	5316 03 02200	●
24,0	121	45	25	5	1	5315 03 02400	5316 03 02400	●
25,0	121	45	25	5	1	5315 03 02500	5316 03 02500	●
26,0	121	45	25	5	1	5315 03 02600	5316 03 02600	●
28,0	121	45	25	5	1	5315 03 02800	5316 03 02800	●
30,0	121	45	25	5	1	5315 03 03000	5316 03 03000	●
32,0	133	53	32	6	1	5315 03 03200	5316 03 03200	●
35,0	133	53	32	6	1	5315 03 03500	5316 03 03500	●
36,0	133	53	32	6	1	5315 03 03600	5316 03 03600	●
40,0*	143	63	32	6	1	5315 03 04000	5316 03 04000	●

* ≠ DIN 844 ● ab Lager / ex stock ○ Lieferzeit 10 – 14 Tage / Delivery time 10 – 14 days

BC Boxen / BC Boxes

Bezeichnung Description	Teile Pieces	Inhalt Content	Artikel-Nr. Part-No.
SF 6	6	1x Ø 6 · 8 · 10 · 12 · 16 · 20 mm	5315 13 30006
SF 6-2	6	1x Ø 4 · 5 · 6 · 8 · 10 · 12 mm	5315 13 30007
SF 8	8	2x Ø 6 · 8 · 10 · 12 mm	5315 13 30008
SF 6 TiALN	6	1x Ø 6 · 8 · 10 · 12 · 16 · 20 mm	5316 13 30006
SF 6-2 TiALN	6	1x Ø 4 · 5 · 6 · 8 · 10 · 12 mm	5316 13 30007
SF 8 TiALN	8	2x Ø 6 · 8 · 10 · 12 mm	5316 13 30008



SCHAFTFRÄSER HSS-E
END MILLS HSS-E

Schaftfräser DIN 844 HSS-E (Co8), lange Ausführung, Typ N

Finishing end mills DIN 844 HSS-E M42 (Co8), long version, type N



Code 5320



Code 5321



Code	P					M			K		N				S	
	1	2	3	4	5	1	2	3	1-2	4	1.1-1.3	1.4-1.5	1.6	2.1-2.6	1	2
5320 · 5321	●	●	●	●					●			●				●

- 4 – 6 Schneiden
- Zentrumschnitt
- Schlichtverzahnung
- Schaftfräser für den universellen Einsatz beim Tauch-, Nut- und Schlitzfräsen sowie Stirn- und Umfangfräsen.

- 4 – 6 cutting edges
- Centre cutting
- Finishing profile
- End mills for universal use in plunge, slot milling as well as face and peripheral milling.

Ø d1 mm	L 1 mm	L 2 mm	Ø d2 / h6 mm	Z	🏠	TiALN		🏠
						Artikel-Nr. Part-No.	Artikel-Nr. Part-No.	
2,0	54	10	6	3	1	5320 03 00200	5321 03 00200	○
3,0	56	12	6	4	1	5320 03 00300	5321 03 00300	○
3,5	59	15	6	4	1	5320 03 00350	5321 03 00350	○
4,0	63	19	6	4	1	5320 03 00400	5321 03 00400	○
4,5	63	19	6	4	1	5320 03 00450	5321 03 00450	○
5,0	68	24	6	4	1	5320 03 00500	5321 03 00500	○
5,5	68	24	6	4	1	5320 03 00550	5321 03 00550	○
6,0	68	24	6	4	1	5320 03 00600	5321 03 00600	●
7,0	80	30	10	4	1	5320 03 00700	5321 03 00700	○
8,0	88	38	10	4	1	5320 03 00800	5321 03 00800	●
9,0	88	38	10	4	1	5320 03 00900	5321 03 00900	○
10,0	95	45	10	4	1	5320 03 01000	5321 03 01000	●
11,0	102	45	12	4	1	5320 03 01100	5321 03 01100	○
12,0	110	53	12	4	1	5320 03 01200	5321 03 01200	●
13,0	110	53	12	4	1	5320 03 01300	5321 03 01300	○
14,0	110	53	12	4	1	5320 03 01400	5321 03 01400	●
15,0	110	53	12	4	1	5320 03 01500	5321 03 01500	○
16,0	123	63	16	4	1	5320 03 01600	5321 03 01600	●
18,0	123	63	16	4	1	5320 03 01800	5321 03 01800	●
20,0	141	75	20	4	1	5320 03 02000	5321 03 02000	●
22,0	141	75	20	5	1	5320 03 02200	5321 03 02200	○
24,0	166	90	25	5	1	5320 03 02400	5321 03 02400	○
25,0	166	90	25	5	1	5320 03 02500	5321 03 02500	○
26,0	166	90	25	5	1	5320 03 02600	5321 03 02600	○
28,0	166	90	25	5	1	5320 03 02800	5321 03 02800	○
30,0	166	90	25	5	1	5320 03 03000	5321 03 03000	○
32,0	186	106	32	6	1	5320 03 03200	5321 03 03200	○
36,0	186	106	32	6	1	5320 03 03600	5321 03 03600	○
40,0*	205	125	32	6	1	5320 03 04000	5321 03 04000	○

* ≠ DIN 844 ● ab Lager / ex stock ○ Lieferzeit 10 – 14 Tage / Delivery time 10 – 14 days

SCHAFTFRÄSER HSS-E
END MILLS HSS-E

Schruppfräser DIN 844 HSS-E PM AITiN, kurz, Typ HR Roughing end mills DIN 844 HSS-E PM AITiN, short, type HR

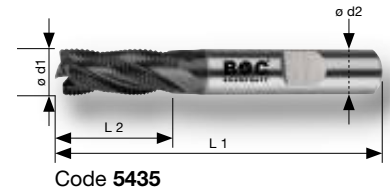

Code	P					M			K		N				S	
	1	2	3	4	5	1	2	3	1-2	4	1.1-1.3	1.4-1.5	1.6	2.1-2.6	1	2
5435			☼		☼					☼		☼			☼	☼

- 4 – 5 Schneiden
- Zentrumschnitt
- Feine Schrappverzahnung
- Schneidstoff HSS-E PM mit AITiN-Beschichtung, besonders für zähe und schwer zerspanbare Stähle geeignet.
- Schrappfräser für den universellen Einsatz beim Tauch-, Nut- und Schlitzfräsen sowie Stirn- und Umfangfräsen.

- 4 – 5 cutting edges
- Centre cutting
- Fine roughing profile
- Cutting material HSS-E PM with AITiN coating, suitable for tough and difficult to machine steels.
- Roughing end mills for universal use in plunge, slot milling as well as face and peripheral milling.

Ø d1 mm	L 1 mm	L 2 mm	Ø d2 / h6 mm	Z		Artikel-Nr. Part-No.	
6	67	13	6	4	1	5435 03 00600	•
7	66	16	10	4	1	5435 03 00700	○
8	69	19	10	4	1	5435 03 00800	•
9	69	19	10	4	1	5435 03 00900	○
10	72	22	10	4	1	5435 03 01000	•
12	83	26	12	4	1	5435 03 01200	•
14	83	26	12	4	1	5435 03 01400	○
16	92	32	16	4	1	5435 03 01600	•
18	92	32	16	4	1	5435 03 01800	○
20	104	38	20	4	1	5435 03 02000	•
22	104	38	20	5	1	5435 03 02200	○
25	121	45	25	5	1	5435 03 02500	•
30	121	45	25	5	1	5435 03 03000	•

• ab Lager / ex stock ○ Lieferzeit 10 – 14 Tage / Delivery time 10 – 14 days



SCHAFTFRÄSER HSS-E
END MILLS HSS-E

Schaftfräser DIN 844 HSS-E PM AITiN, kurz, Typ N

Finishing end mills DIN 844 HSS-E PM AITiN, short, type N

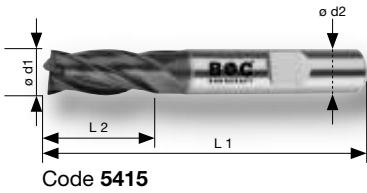

Code 5415



Code	P					M			K		N				S	
	1	2	3	4	5	1	2	3	1-2	4	1.1-1.3	1.4-1.5	1.6	2.1-2.6	1	2
5415																

- 4 – 5 Schneiden
- Zentrumschnitt
- Schneidstoff HSS-E PM mit AITiN-Beschichtung, besonders für zähe und schwer zerspanbare Stähle geeignet.
- Schaftfräser für den universellen Einsatz beim Tauch-, Nut- und Schlitzfräsen sowie Stirn- und Umfangfräsen.

- 4 – 5 cutting edges
- Centre cutting
- Cutting material HSS-E PM with AITiN coating, suitable for tough and difficult to machine steels.
- End mills for universal use in plunge, slot milling as well as face and peripheral milling.

Ø d1 mm	L 1 mm	L 2 mm	Ø d2 / h6 mm	Z		Artikel-Nr. Part-No.	
2	51	7	6	4	1	5415 03 00200	•
3	52	8	6	4	1	5415 03 00300	○
4	55	11	6	4	1	5415 03 00400	•
5	57	13	6	4	1	5415 03 00500	○
6	57	13	6	4	1	5415 03 00600	•
8	69	19	10	4	1	5415 03 00800	•
10	72	22	10	4	1	5415 03 01000	•
12	83	26	12	4	1	5415 03 01200	•
14	83	26	12	4	1	5415 03 01400	•
16	92	32	16	4	1	5415 03 01600	•
18	92	32	16	4	1	5415 03 01800	•
20	104	38	20	4	1	5415 03 02000	•
25	121	45	25	5	1	5415 03 02500	○
30	121	45	25	5	1	5415 03 03000	○

• ab Lager / ex stock ○ Lieferzeit 10 – 14 Tage / Delivery time 10 – 14 days



SCHAFTFRÄSER HSS-E
END MILLS HSS-E

Schaftfräser DIN 844 HSS-E PM AITiN, lange Ausführung, Typ N Finishing end mills DIN 844 HSS-E PM AITiN, long version, type N

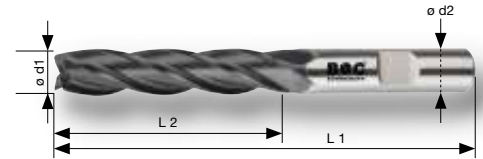

Code 5420



Code	P					M			K		N				S	
	1	2	3	4	5	1	2	3	1-2	4	1.1-1.3	1.4-1.5	1.6	2.1-2.6	1	2
5420		☉	☉	☉	☉		☉			☉		☉			☉	☉

- 4 – 6 Schneiden
- Zentrumschnitt
- Schneidstoff HSS-E PM mit AITiN-Beschichtung, besonders für zähe und schwer zerspanbare Stähle geeignet.
- Schaftfräser für den universellen Einsatz beim Tauch-, Nut- und Schlitzfräsen sowie Stirn- und Umfangfräsen.
- 4 – 6 cutting edges
- Centre cutting
- Cutting material HSS-E PM with AITiN coating, suitable for tough and difficult to machine steels.
- End mills for universal use in plunge, slot milling as well as face and peripheral milling.

Ø d1 mm	L 1 mm	L 2 mm	Ø d2 / h6 mm	Z		Artikel-Nr. Part-No.	
3	56	12	6	4	1	5420 03 00300	○
6	68	24	6	4	1	5420 03 00600	○
8	88	38	10	4	1	5420 03 00800	○
10	95	45	10	4	1	5420 03 01000	○
12	110	53	12	4	1	5420 03 01200	○
14	110	53	12	4	1	5420 03 01400	○
16	123	63	16	4	1	5420 03 01600	○
18	123	63	16	4	1	5420 03 01800	○
20	141	75	20	4	1	5420 03 02000	○
32	186	106	32	6	1	5420 03 03200	○

• ab Lager / ex stock ○ Lieferzeit 10 – 14 Tage / Delivery time 10 – 14 days















SCHAFTFRÄSER HSS-E
END MILLS HSS-E

SCHAFTFRÄSER VHM
SOLID CARBIDE END MILLS











































































































SCHAFTFRÄSER VHM SOLID CARBIDE END MILLS

	DIN	Qualität Quality	Typ Type	Version	Schneiden Flutes	Schaft Shank	Bezeichnung Description	Code	Seite Page
		VHM SC	W	kurz short	1	DIN 6535 HA	Einzahnfräser Single fluted end mills	5500	138
		VHM SC	W	kurz short	2	DIN 6535 HA/HB	Langlochfräser Slot end mills	5505 5506	139
	~ 6527 L	VHM SC	W	lang long	3	DIN 6535 HA/HB	Bohrnutenfräser Slot end mills	5510 5511	140
	~ 6527 L	VHM SC	N	kurz short	2	DIN 6535 HA/HB	Langlochfräser, AITiN Slot end mills, AITiN	5515 5516	141
	~ 6527 L	VHM SC	N	lang long	3	DIN 6535 HA/HB	Bohrnutenfräser, AITiN Slot end mills, AITiN	5520 5521	142
	~ 6527 L	VHM SC	N	lang long	4	DIN 6535 HA/HB	Schaftfräser, AITiN Finishing end mills, AITiN	5525 5526	143
	~ 6527 L	VHM SC	N	extra lang / long	4	DIN 6535 HA/HB	Schaftfräser, AITiN Finishing end mills, AITiN	5530 5531	144
	6527 L	VHM SC	HPC	lang long	4	DIN 6535 HA/HB	HPC Schaftfräser, AITiN HPC end mills, AITiN	5535 5536	145
	~ 6527 L	VHM SC	NH	lang long	6	DIN 6535 HA/HB	Schaftfräser, AITiN Finishing end mills, AITiN	5540 5541	146
	~ 6527 L	VHM SC	HRf	lang long	3 – 5	DIN 6535 HA/HB	Schruppfräser, AITiN Roughing end mills, AITiN	5545 5546	147
	~ 6527 L	VHM SC	N	lang long	2	DIN 6535 HA	Radiusfräser, AITiN Ball nose end mills, AITiN	5550	148
	-	VHM SC	N	lang long	4	DIN 6535 HA	Entgratfräser, TiALN Deburring end mills, TiALN	5555	149

Anwendungsempfehlung für VHM Schaftfräser

Application recommendation for solid carbide end mills







































									
DIN	-	-	~ 6527 L	~ 6527 L	~ 6527 L	~ 6527 L	~ 6527 L	6527 L	~ 6527 L
Typ Type	W	W	W	N	N	N	N	HPC	NH
Schneidstoff Cutting material	VHM / SC	VHM / SC	VHM / SC	VHM / SC	VHM / SC	VHM / SC	VHM / SC	VHM / SC	VHM / SC
Beschichtung Coating	-	-	-	AlTiN	AlTiN	AlTiN	AlTiN	AlTiN	AlTiN
Schneiden Cutting edges	1	2	3	2	3	4	4	4	6
Bereich Range	3 – 12 mm	2 – 20 mm	2 – 20 mm	2 – 20 mm	2 – 20 mm	2 – 20 mm	3 – 20 mm	3 – 20 mm	3 – 20 mm
Qualität Quality	★★★★★	★★★★★	★★★★★	★★★★★	★★★★★	★★★★★	★★★★★	★★★★★	★★★★★
Code	5500	5505 5506	5510 5511	5515 5516	5520 5521	5525 5526	5530 5531	5535 5536	5540 5541
Seite Page	138	139	140	141	142	143	144	145	146
P	1								
	2								
	3								
	4								
	5								
M	1								
	2								
	3								
K	1 – 2								
	4								
N	1.1 – 1.3								
	1.4 – 1.5								
	1.6								
	2.1 – 2.6								
S	1								
	2								
H	1.1 – 1.3 (≤ 48 HRC)								
	1.4 – 1.5 (≤ 66 HRC)								

 geeignet / suitable  bedingt geeignet / limited suitable



TECHNISCHE DETAILS
TECHNICAL DETAILS

Anwendungsempfehlung für VHM Schafffräser Application recommendation for solid carbide end mills

		
~ 6527 L	~ 6527 L	-
HRf	N	N
VHM / SC	VHM / SC	VHM / SC
AlTiN	AlTiN	TiAlN
3 – 5	2	4
5 – 25 mm	2 – 20 mm	4 – 12 mm
★★★★★	★★★★★	★★★★★
5545 5546	5550	5555
147	148	149
		
		
		
		
		
		
		
		
		
		
		
		
		
		
		

 geeignet / suitable  bedingt geeignet / limited suitable



TECHNISCHE DETAILS
TECHNICAL DETAILS

VHM Einzahnfräser, Typ W

Solid carbide single fluted end mills, type W

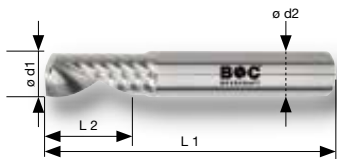

Code 5500



Code	P					M			K		N				S		H	
	1	2	3	4	5	1	2	3	1-2	4	1.1-1.3	1.4-1.5	1.6	2.1-2.6	1	2	1.1-1.3	1.4-1.5
5500											☉	☉		☉				

- 1 Schneide
- Zentrumschnitt
- Zum Fräsen, Einstechen und Konturfräsen
- Speziell für die Bearbeitung von weichen Werkstoffen wie Aluminium, NE-Metallen und Kunststoffen

- 1 cutting edge
- Centre cutting
- For milling, grooving and contour milling
- Especially for machining soft materials such as aluminum, non-ferrous metals and plastics

HA

Ø d1 mm	L 1 mm	L 2 mm	Ø d2 / h6 mm	Z		Artikel-Nr. Part-No.
3	50	8	6	1	1	5500 03 00300
4	54	11	6	1	1	5500 03 00400
5	54	13	6	1	1	5500 03 00500
6	54	13	6	1	1	5500 03 00600
8	58	19	8	1	1	5500 03 00800
10	66	22	10	1	1	5500 03 01000
12	73	26	12	1	1	5500 03 01200





VHM Langlochfräser mit 2 Schneiden, kurz, Typ W

Solid carbide slot end mills with 2 cutting edges, short, type W

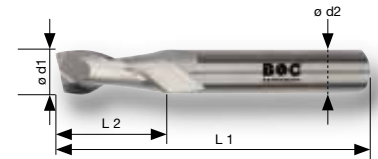

Code 5505 · 5506



Code	P					M			K		N				S		H	
	1	2	3	4	5	1	2	3	1-2	4	1.1-1.3	1.4-1.5	1.6	2.1-2.6	1	2	1.1-1.3	1.4-1.5
5505 · 5506											☉	☉	☉	☉				

- 2 Schneiden
- Zentrumschnitt
- Geeignet für Tauch-, Nut- und Passungsfräsen
- Speziell für die Bearbeitung von weichen Werkstoffen wie Aluminium, NE-Metallen und Kunststoffen

- 2 cutting edges
- Centre cutting
- Suitable for plunge, slot and fitting milling
- Especially for machining soft materials such as aluminum, non-ferrous metals and plastics

Ø d1 mm	L 1 mm	L 2 mm	Ø d2 / h6 mm	Z	📐	HA	HB
						Artikel-Nr. Part-No.	Artikel-Nr. Part-No.
2	40	7	4	2	1	5505 03 00200	-
3	50	9	4	2	1	5505 03 00300	-
4	57	11	6	2	1	5505 03 00400	5506 03 00400
5	57	13	6	2	1	5505 03 00500	5506 03 00500
6	57	13	6	2	1	5505 03 00600	5506 03 00600
8	63	19	8	2	1	5505 03 00800	5506 03 00800
10	72	22	10	2	1	5505 03 01000	5506 03 01000
12	83	26	12	2	1	5505 03 01200	5506 03 01200
14	83	26	14	2	1	5505 03 01400	5506 03 01400
16	92	32	16	2	1	5505 03 01600	5506 03 01600
18	92	32	18	2	1	5505 03 01800	5506 03 01800
20	104	38	20	2	1	5505 03 02000	5506 03 02000



VHM SCHAFTFRÄSER
SOLID CARBIDE END MILLS

VHM Bohrnutenfräser mit 3 Schneiden, lang, Typ W

Solid carbide slot end mills with 3 cutting edges, long version, type W

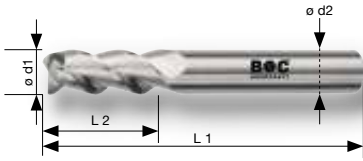

Code 5510 · 5511



Code	P					M			K		N				S		H	
	1	2	3	4	5	1	2	3	1-2	4	1.1-1.3	1.4-1.5	1.6	2.1-2.6	1	2	1.1-1.3	1.4-1.5
5510 · 5511											☉	☉	☉	☉				

- 3 Schneiden
- Zentrumschnitt
- Geeignet für Tauch-, Nut- und Passungsfräsen
- Speziell für die Bearbeitung von weichen Werkstoffen wie Aluminium, NE-Metallen und Kunststoffen

- 3 cutting edges
- Centre cutting
- Suitable for plunge, slot and fitting milling
- Especially for machining soft materials such as aluminum, non-ferrous metals and plastics

HA

HB

Ø d1 mm	L 1 mm	L 2 mm	Ø d2 / h6 mm	Z		Artikel-Nr. Part-No.	Artikel-Nr. Part-No.
2	50	6	4	3	1	5510 03 00200	-
3	57	8	6	3	1	5510 03 00300	5511 03 00300
4	57	11	6	3	1	5510 03 00400	5511 03 00400
5	57	13	6	3	1	5510 03 00500	5511 03 00500
6	57	13	6	3	1	5510 03 00600	5511 03 00600
8	63	19	8	3	1	5510 03 00800	5511 03 00800
10	72	22	10	3	1	5510 03 01000	5511 03 01000
12	83	26	12	3	1	5510 03 01200	5511 03 01200
14	83	26	14	3	1	5510 03 01400	5511 03 01400
16	92	32	16	3	1	5510 03 01600	5511 03 01600
20	104	38	20	3	1	5510 03 02000	5511 03 02000



VHM SCHAFTFRÄSER
SOLID CARBIDE END MILLS

VHM Langlochfräser mit 2 Schneiden, kurz, Typ N, AITiN

Solid carbide slot end mills with 2 cutting edges, short, type N, AITiN

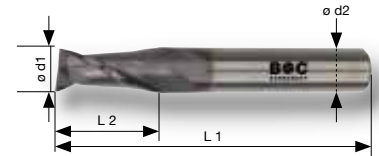

Code 5515 · 5516



Code	P					M			K		N				S		H		
	1	2	3	4	5	1	2	3	1-2	4	1.1-1.3	1.4-1.5	1.6	2.1-2.6	1	2	1.1-1.3	1.4-1.5	
5515 · 5516	☉	☉	☉	☉	☉	☉	☉	☉	☉	☉	☉	☉	☉	☉	☉	☉	☉	☉	☉

- 2 Schneiden
- Zentrumschnitt
- Geeignet für Tauch-, Nut- und Passungsfräsen

- 2 cutting edges
- Centre cutting
- Suitable for plunge, slot and fitting milling

HA

HB

Ø d1 mm	L 1 mm	L 2 mm	Ø d2 / h6 mm	Z		Artikel-Nr. Part-No.	Artikel-Nr. Part-No.
2	40	6	4	2	1	5515 03 00200	-
3	50	8	4	2	1	5515 03 00300	-
4	50	11	6	2	1	5515 03 00400	5516 03 00400
5	50	13	6	2	1	5515 03 00500	5516 03 00500
6	50	13	6	2	1	5515 03 00600	5516 03 00600
7	60	16	8	2	1	5515 03 00700	5516 03 00700
8	60	19	8	2	1	5515 03 00800	5516 03 00800
9	70	19	10	2	1	5515 03 00900	5516 03 00900
10	70	22	10	2	1	5515 03 01000	5516 03 01000
11	75	22	12	2	1	5515 03 01100	5516 03 01100
12	75	26	12	2	1	5515 03 01200	5516 03 01200
14	75	26	14	2	1	5515 03 01400	5516 03 01400
16	75	26	16	2	1	5515 03 01600	5516 03 01600
18	100	32	18	2	1	5515 03 01800	5516 03 01800
20	100	32	20	2	1	5515 03 02000	5516 03 02000



VHM SCHAFTFRÄSER
SOLID CARBIDE END MILLS

VHM Bohrutenfräser mit 3 Schneiden, lang, Typ N, AITiN

Solid carbide slot end mills with 3 cutting edges, long version, type N, AITiN

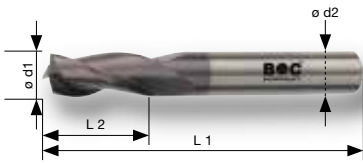

Code 5520 · 5521



Code	P					M			K		N				S		H	
	1	2	3	4	5	1	2	3	1-2	4	1.1-1.3	1.4-1.5	1.6	2.1-2.6	1	2	1.1-1.3	1.4-1.5
5520 · 5521	☉	☉	☉	☉	☉	☉	☉	☉	☉	☉					☉	☉		

- 3 Schneiden
- Zentrumschnitt
- Geeignet für Tauch-, Nut- und Passungsfräsen

- 3 cutting edges
- Centre cutting
- Suitable for plunge, slot and fitting milling

HA

HB

Ø d1 mm	L 1 mm	L 2 mm	Ø d2 / h6 mm	Z		Artikel-Nr. Part-No.	Artikel-Nr. Part-No.
2	50	6	4	3	1	5520 03 00200	-
3	57	8	6	3	1	5520 03 00300	5521 03 00300
4	57	11	6	3	1	5520 03 00400	5521 03 00400
5	57	13	6	3	1	5520 03 00500	5521 03 00500
6	57	13	6	3	1	5520 03 00600	5521 03 00600
8	63	19	8	3	1	5520 03 00800	5521 03 00800
10	72	22	10	3	1	5520 03 01000	5521 03 01000
12	83	26	12	3	1	5520 03 01200	5521 03 01200
14	83	26	14	3	1	5520 03 01400	5521 03 01400
16	92	32	16	3	1	5520 03 01600	5521 03 01600
20	104	38	20	3	1	5520 03 02000	5521 03 02000



VHM SCHAFTFRÄSER
SOLID CARBIDE END MILLS

VHM Schaftfräser mit 4 Schneiden, lang, Typ N, AITiN

Solid carbide finishing end mills with 4 cutting edges, long version, type N, AITiN

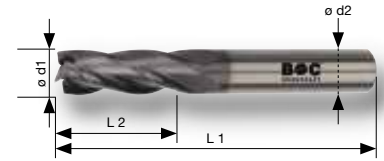

Code 5525 · 5526



Code	P					M			K		N				S		H	
	1	2	3	4	5	1	2	3	1-2	4	1.1-1.3	1.4-1.5	1.6	2.1-2.6	1	2	1.1-1.3	1.4-1.5
5525 · 5526	☞	☞	☞	☞	☞	☞	☞	☞	☞	☞	☞	☞	☞	☞	☞	☞		

- 4 Schneiden
- Zentrumschnitt
- Schlichtverzahnung
- Schaftfräser für den universellen Einsatz beim Tauch-, Nut- und Schlitzfräsen sowie Stirn- und Umfangfräsen

- 4 cutting edges
- Centre cutting
- Finishing profile
- End mills for universal use in plunge, slot milling as well as face and peripheral milling

Ø d1 mm	L 1 mm	L 2 mm	Ø d2 / h6 mm	Z	📐	HA	HB
						Artikel-Nr. Part-No.	Artikel-Nr. Part-No.
2	32	8	2	4	1	5525 03 00200	-
3	38	12	3	4	1	5525 03 00300	-
4	40	12	4	4	1	5525 03 00400	-
5	50	15	5	4	1	5525 03 00500	-
6	57	16	6	4	1	5525 03 00600	5526 03 00600
7	60	16	8	4	1	5525 03 00700	5526 03 00700
8	68	22	8	4	1	5525 03 00800	5526 03 00800
9	72	22	10	4	1	5525 03 00900	5526 03 00900
10	72	25	10	4	1	5525 03 01000	5526 03 01000
11	83	26	12	4	1	5525 03 01100	5526 03 01100
12	83	28	12	4	1	5525 03 01200	5526 03 01200
14	83	28	14	4	1	5525 03 01400	5526 03 01400
16	92	35	16	4	1	5525 03 01600	5526 03 01600
18	92	35	18	4	1	5525 03 01800	5526 03 01800
20	104	40	20	4	1	5525 03 02000	5526 03 02000



VHM SCHAFTFRÄSER
SOLID CARBIDE END MILLS

VHM Schaftfräser mit 4 Schneiden, extra lang, Typ N, AITiN

Solid carbide finishing end mills with 4 cutting edges, extra long version, type N, AITiN

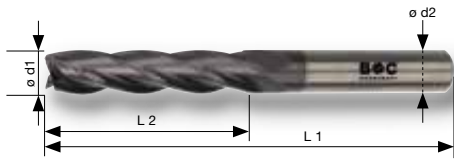

Code 5530 · 5531



Code	P					M			K		N				S		H		
	1	2	3	4	5	1	2	3	1-2	4	1.1-1.3	1.4-1.5	1.6	2.1-2.6	1	2	1.1-1.3	1.4-1.5	
5530 · 5531	☉	☉	☉	☉	☉				☉	☉	☉	☉	☉	☉					

- 4 Schneiden
- Zentrumschnitt
- Schlichtverzahnung
- Schaftfräser für den universellen Einsatz beim Tauch-, Nut- und Schlitzfräsen sowie Stirn- und Umfangfräsen

- 4 cutting edges
- Centre cutting
- Finishing profile
- End mills for universal use in plunge, slot milling as well as face and peripheral milling

HA

HB

Ø d1 mm	L 1 mm	L 2 mm	Ø d2 / h6 mm	Z		Artikel-Nr. Part-No.	Artikel-Nr. Part-No.
3	57	15	6	4	1	5530 03 00300	5531 03 00300
4	63	19	6	4	1	5530 03 00400	5531 03 00400
5	68	24	6	4	1	5530 03 00500	5531 03 00500
6	68	24	6	4	1	5530 03 00600	5531 03 00600
8	88	38	8	4	1	5530 03 00800	5531 03 00800
10	95	45	10	4	1	5530 03 01000	5531 03 01000
12	110	53	12	4	1	5530 03 01200	5531 03 01200
14	110	53	14	4	1	5530 03 01400	5531 03 01400
16	125	63	16	4	1	5530 03 01600	5531 03 01600
18	125	63	18	4	1	5530 03 01800	5531 03 01800
20	141	75	20	4	1	5530 03 02000	5531 03 02000



VHM SCHAFTFRÄSER
SOLID CARBIDE END MILLS



VHM HPC Schaftfräser mit 4 Schneiden, lang, AITiN

Solid carbide HPC end mills with 4 cutting edges, long version, AITiN



Code 5535 · 5536



Code	P					M			K		N				S		H	
	1	2	3	4	5	1	2	3	1-2	4	1.1-1.3	1.4-1.5	1.6	2.1-2.6	1	2	1.1-1.3	1.4-1.5
5535 · 5536	⊗	⊗	⊗	⊗	⊗	⊗	⊗	⊗	⊗	⊗							⊗	

- 4 Schneiden
- Zentrumschnitt
- Variabler Spiralwinkel und Halsfreischliff
- Zum Schruppen und Schlichten
- Hochleistungsfräser für den universellen Einsatz beim Tauch-, Nut- und Schlitzfräsen sowie Stirn- und Umfangfräsen

- 4 cutting edges
- Centre cutting
- Variable helix angle with neck clearance
- For roughing and finishing
- High performance end mills for universal use in plunge, slot milling as well as face and peripheral milling



Ø d1 mm	L 1 mm	L 2 mm	Ø d2 / h6 mm	Z		Artikel-Nr. Part-No.	Artikel-Nr. Part-No.
3	57	8	6	4	1	5535 03 00300	5536 03 00300
4	57	11	6	4	1	5535 03 00400	5536 03 00400
5	57	13	6	4	1	5535 03 00500	5536 03 00500
6	57	13	6	4	1	5535 03 00600	5536 03 00600
8	63	19	8	4	1	5535 03 00800	5536 03 00800
10	72	22	10	4	1	5535 03 01000	5536 03 01000
12	83	26	12	4	1	5535 03 01200	5536 03 01200
14	83	26	14	4	1	5535 03 01400	5536 03 01400
16	92	32	16	4	1	5535 03 01600	5536 03 01600
20	104	38	20	4	1	5535 03 02000	5536 03 02000



VHM SCHAFTFRÄSER
SOLID CARBIDE END MILLS

VHM Schaftfräser mit 6 Schneiden, lang, Typ NH, AITiN

Solid carbide finishing end mills with 6 cutting edges, long version, type NH, AITiN



Code 5540 · 5541



Code	P					M			K		N				S		H		
	1	2	3	4	5	1	2	3	1-2	4	1.1-1.3	1.4-1.5	1.6	2.1-2.6	1	2	1.1-1.3	1.4-1.5	
5540 · 5541	☉	☉	☉	☉	☉	☉	☉	☉	☉	☉	☉	☉	☉	☉	☉	☉	☉	☉	☉

- 6 Schneiden
- Ohne Zentrumschnitt
- Mehrzahn-Schaftfräser zum Feinstschlichten von hochlegierten Werkstoffen und Grauguss bis ca. 1600 N/mm²

- 6 cutting edges
- Without centre cutting
- Multi tooth end mills for fine finishing high alloyed materials and grey cast iron up to approx. 1600 N/mm² (48,5 HRC)

HA

HB

Ø d1 mm	L 1 mm	L 2 mm	Ø d2 / h6 mm	Z		Artikel-Nr. Part-No.	Artikel-Nr. Part-No.
3	50	10	4	6	1	5540 03 00300	-
4	57	11	6	6	1	5540 03 00400	5541 03 00400
5	57	13	6	6	1	5540 03 00500	5541 03 00500
6	57	13	6	6	1	5540 03 00600	5541 03 00600
8	63	19	8	6	1	5540 03 00800	5541 03 00800
10	72	22	10	6	1	5540 03 01000	5541 03 01000
12	83	26	12	6	1	5540 03 01200	5541 03 01200
14	83	26	14	6	1	5540 03 01400	5541 03 01400
16	92	32	16	6	1	5540 03 01600	5541 03 01600
18	92	32	18	6	1	5540 03 01800	5541 03 01800
20	104	38	20	6	1	5540 03 02000	5541 03 02000



VHM SCHAFTFRÄSER
SOLID CARBIDE END MILLS

VHM Schruppfräser mit 3-5 Schneiden, lang, Typ HRf, AITiN

Solid carbide roughing end mills with 3-5 cutting edges, long version, type HRf, AITiN



Code	P					M			K		N			S		H		
	1	2	3	4	5	1	2	3	1-2	4	1.1-1.3	1.4-1.5	1.6	2.1-2.6	1	2	1.1-1.3	1.4-1.5
5545 · 5546			⊗		⊗				⊗	⊗				⊗			⊗	⊗

- 3 – 5 Schneiden
- Zentrumschnitt
- Feine Schruppverzahnung
- Produziert kurze Späne bei guter Spanabfuhr. Geeignet zum Fräsen von gehärteten Werkstoffen sowie Grau-, oder Hartguss bis ca. 54 HRC.
- 3 – 5 cutting edges
- Centre cutting
- Fine roughing profile
- Produces short chips with good chip evacuation. Suitable for milling hardened materials as well as grey and chilled cast iron up to 54 HRC.



Ø d1 mm	L 1 mm	L 2 mm	Ø d2 / h6 mm	Z		Artikel-Nr. Part-No.	Artikel-Nr. Part-No.
5	57	16	6	3	1	5545 03 00500	5546 03 00500
6	57	16	6	3	1	5545 03 00600	5546 03 00600
8	63	19	8	3	1	5545 03 00800	5546 03 00800
10	72	22	10	4	1	5545 03 01000	5546 03 01000
12	83	26	12	4	1	5545 03 01200	5546 03 01200
16	92	32	16	4	1	5545 03 01600	5546 03 01600
20	104	38	20	4	1	5545 03 02000	5546 03 02000
25	121	45	25	5	1	5545 03 02500	5546 03 02500



VHM SCHAFTFRÄSER
SOLID CARBIDE END MILLS

VHM Radiusfräser mit 2 Schneiden, lang, Typ N, AITiN

Solide carbide ball nose end mills with 2 cutting edges, long version, type N, AITiN

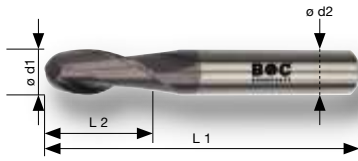

Code 5550



Code	P					M			K		N				S		H		
	1	2	3	4	5	1	2	3	1-2	4	1.1-1.3	1.4-1.5	1.6	2.1-2.6	1	2	1.1-1.3	1.4-1.5	
5550	☉	☉	☉	☉	☉	☉	☉	☉	☉	☉	☉	☉	☉	☉	☉	☉	☉	☉	☉

- 2 Schneiden
- Zentrumschnitt
- Schafffräser mit Vollradius zum Kopierfräsen, z.B. im Gesenk- und Formenbau

- 2 cutting edges
- Centre cutting
- End mill with full radius for copy milling, e.g. in die and mold making

HA

Ø d1 mm	L 1 mm	L 2 mm	Ø d2 / h6 mm	Z		Artikel-Nr. Part-No.
2	40	6	4	2	1	5550 03 00200
3	50	7	4	2	1	5550 03 00300
4	50	8	6	2	1	5550 03 00400
5	50	10	6	2	1	5550 03 00500
6	50	10	6	2	1	5550 03 00600
8	60	19	8	2	1	5550 03 00800
10	70	22	10	2	1	5550 03 01000
12	75	26	12	2	1	5550 03 01200
14	75	26	14	2	1	5550 03 01400
16	75	26	16	2	1	5550 03 01600
18	100	32	18	2	1	5550 03 01800
20	100	32	20	2	1	5550 03 02000



VHM SCHAFTFRÄSER
SOLID CARBIDE END MILLS



VHM Entgratfräser mit 4 Schneiden, lang, Typ N, TiALN
 Solid carbide deburring end mills with 4 cutting edges, long version, type N, TiALN

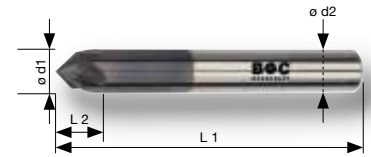

Code 5555



Code	P					M			K		N				S		H		
	1	2	3	4	5	1	2	3	1-2	4	1.1-1.3	1.4-1.5	1.6	2.1-2.6	1	2	1.1-1.3	1.4-1.5	
5555	⊗	⊗	⊗	⊗	⊗	⊗	⊗	⊗	⊗	⊗	⊗	⊗	⊗	⊗	⊗	⊗	⊗	⊗	⊗

- 4 Schneiden
- Zentrumschnitt
- Zum Fasenfräsen, Entgraten und Senken

- 4 cutting edges
- Centre cutting
- For chamfering, deburring and countersinking



Ø d1 mm	L 1 mm	L 2 mm	Ø d2 / h6 mm	Z		Artikel-Nr. Part-No.
4	50	4,2	4	4	1	5555 03 00490
6	57	6,2	6	4	1	5555 03 00690
8	63	8,3	8	4	1	5555 03 00890
10	72	10,4	10	4	1	5555 03 01090
12	83	12,5	12	4	1	5555 03 01290







VHM SCHAFTFRÄSER
 SOLID CARBIDE END MILLS

KERNBOHRER · HM-MEHRBEREICHS-LOCHSÄGEN
CORE DRILLS · TCT-MULTIGRADE HOLE SAWS



KERNBOHRER · HM-MEHRBEREICHS-LOCHSÄGEN CORE DRILLS · TCT-MULTIGRADE HOLE SAWS

	Qualität Quality	Bezeichnung Description	Code	Seite Page
Kernbohrer + Zubehör / Core drills + accessories				
		HSS Kernbohrer mit Weldonschaft 30 und 55 mm Schnitttiefe Core drills with weldon shank 30 and 55 mm cutting depth	1950	153
		HSS-E Co Kernbohrer mit Weldonschaft 30 und 55 mm Schnitttiefe Core drills with weldon shank 30 and 55 mm cutting depth	1951	154
		HM TCT Kernbohrer HM mit Weldonschaft 35 und 55 mm Schnitttiefe Core drills TCT with weldon shank 35 and 55 mm cutting depth	1952	155
		- Zubehör für Kernbohrer Accessories for core drills	1955 – 1957	156
HM-Lochsägen / TCT-Hole saws				
		HM TCT Mehrbereichs-Lochsägen HM + Zubehör Multigrade hole saws TCT + accessories	1920 1925	157

Lieferbare Kernbohrer-Ausführungen Available core drill versions



Kernbohrer aus Hochleistungs-Schnellstahl. Geeignet für Stahl (T-Träger, großformatige Bleche), Stahlguss, Bunt- und Leichtmetalle.

Core drills made of high speed steel. Suitable for steel (T-girder, large-size sheets), cast steel and non-ferrous metals.



Kernbohrer aus kobaltlegiertem Hochleistungs-Schnellstahl. Geeignet für Stahl (T-Träger, großformatige Bleche), rostfreien Stahl wie V2A und V4A, Bunt- und Leichtmetalle.

Core drills made of cobalt-alloyed high speed steel. Suitable for steel (T-girder, large-size sheets), stainless steel like AISI 304 + AISI 316 and non-ferrous metals.



Kernbohrer mit Hartmetall-Schneiden. Geeignet für Stahl (T-Träger, großformatige Bleche), rostfreien Stahl wie V2A und V4A, Bunt- und Leichtmetalle.

Core drills with TC-cutters, Suitable for steel (T-girder, large-size sheets), stainless steel like AISI 304 + AISI 316 and non-ferrous metals.



Kernbohrer:

Bis zu 10 x schnellere Bohrzeit im Vergleich zu Spiralbohrern!

Core drills:

Compared with a twist drill a core drill cuts up to 10 times faster!



Kernbohrer zerspant nur einen Ring (siehe grüner Bereich).

Vorteil: Kosten- und Zeitersparnis!

A core drill cuts only a ring (see green part).

Advantage: You can save costs and time!



Bei Spiralbohrern wird der komplette Bohrerdurchmesser zerspant (siehe blauer Bereich).

Nachteil: Hoher Kraft- und Zeitaufwand!

A twist drill cuts the entire diameter of the hole (see blue part).

Disadvantage: High effort of energy and time!



Kernbohrer HSS mit Weldonschaft (3/4")
Core drills HSS with Weldon shank (3/4")



Code 1950 • 30 mm



Code 1950 • 55 mm



Hochleistungs-Schnellstahl, CBN-geschliffen, passend in allen Säulen- und Magnetständerbohrmaschinen mit Weldon-schaft-Aufnahme. Geeignet für Stahl (T-Träger, großformatige Bleche), Stahlguss, Bunt- und Leichtmetalle.

High Speed Steel, CBN-ground, suitable for all magnetic drill machines with Weldon attachment. For drilling steel (T-steel-girders, large-size sheets), cast steel, non-ferrous metal.

Ø d1 mm	Ø d2 mm	L 1 mm	📏	Artikel-Nr. Part-No.	L 1 mm	📏	Artikel-Nr. Part-No.
12	19	30	1	1950 03 01225	55	1	1950 03 01250
13	19	30	1	1950 03 01325	55	1	1950 03 01350
14	19	30	1	1950 03 01425	55	1	1950 03 01450
15	19	30	1	1950 03 01525	55	1	1950 03 01550
16	19	30	1	1950 03 01625	55	1	1950 03 01650
17	19	30	1	1950 03 01725	55	1	1950 03 01750
18	19	30	1	1950 03 01825	55	1	1950 03 01850
19	19	30	1	1950 03 01925	55	1	1950 03 01950
20	19	30	1	1950 03 02025	55	1	1950 03 02050
21	19	30	1	1950 03 02125	55	1	1950 03 02150
22	19	30	1	1950 03 02225	55	1	1950 03 02250
23	19	30	1	1950 03 02325	55	1	1950 03 02350
24	19	30	1	1950 03 02425	55	1	1950 03 02450
25	19	30	1	1950 03 02525	55	1	1950 03 02550
26	19	30	1	1950 03 02625	55	1	1950 03 02650
27	19	30	1	1950 03 02725	55	1	1950 03 02750
28	19	30	1	1950 03 02825	55	1	1950 03 02850
29	19	30	1	1950 03 02925	55	1	1950 03 02950
30	19	30	1	1950 03 03025	55	1	1950 03 03050
31	19	30	1	1950 03 03125	55	1	1950 03 03150
32	19	30	1	1950 03 03225	55	1	1950 03 03250
35	19	30	1	1950 03 03525	55	1	1950 03 03550
40	19	30	1	1950 03 04025	55	1	1950 03 04050
45	19	30	1	1950 03 04525	55	1	1950 03 04550
50	19	30	1	1950 03 05025	55	1	1950 03 05050
55	19	30	1	1950 03 05525	55	1	1950 03 05550
60	19	30	1	1950 03 06025	55	1	1950 03 06050

BC Kassetten / BC Boxes

Bezeichnung Description	Teile Pieces	Inhalt Content	Artikel-Nr. Part-No.
KB 3 HSS	4	Ø 14 · 18 · 22 x 30 mm + Auswerferstift / Ejector pin	1950 14 30003
KB 6 HSS	7	Ø 12 · 14 · 16 · 18 · 20 · 22 x 30 mm + Auswerferstift / Ejector pin	1950 13 10006



KB 3 HSS



KB 6 HSS

Kernbohrer HSS-E kobaltlegiert, mit Weldonschaft (3/4")
Core drills HSS-E cobalt alloyed, with Weldon shank (3/4")



Code 1951 • 30 mm



Code 1951 • 55 mm



Kobaltlegierter Hochleistungs-Schnellstahl, CBN geschliffen, passend in allen Säulen- und Magnetständerbohrmaschinen mit Weldonschaft-Aufnahme. Geeignet für Stahl (T-Träger, großformatige Bleche), rostfreien Stahl wie V2A und V4A, Bunt- und Leichtmetalle.

High Speed Steel cobalt-alloyed, CBN-ground, suitable for all magnetic drill machines with Weldon attachment. For drilling steel (T-steel-girder, large-size sheets), stainless steel like AISI 304 + AISI 316, non-ferrous metal.

Ø d1 mm	Ø d2 mm	L 1 mm	📏	Artikel-Nr. Part-No.	L 1 mm	📏	Artikel-Nr. Part-No.
12	19	30	1	1951 03 01225	55	1	1951 03 01250
13	19	30	1	1951 03 01325	55	1	1951 03 01350
14	19	30	1	1951 03 01425	55	1	1951 03 01450
15	19	30	1	1951 03 01525	55	1	1951 03 01550
16	19	30	1	1951 03 01625	55	1	1951 03 01650
17	19	30	1	1951 03 01725	55	1	1951 03 01750
18	19	30	1	1951 03 01825	55	1	1951 03 01850
19	19	30	1	1951 03 01925	55	1	1951 03 01951
20	19	30	1	1951 03 02025	55	1	1951 03 02050
21	19	30	1	1951 03 02125	55	1	1951 03 02150
22	19	30	1	1951 03 02225	55	1	1951 03 02250
23	19	30	1	1951 03 02325	55	1	1951 03 02350
24	19	30	1	1951 03 02425	55	1	1951 03 02450
25	19	30	1	1951 03 02525	55	1	1951 03 02550
26	19	30	1	1951 03 02625	55	1	1951 03 02650
27	19	30	1	1951 03 02725	55	1	1951 03 02750
28	19	30	1	1951 03 02825	55	1	1951 03 02850
29	19	30	1	1951 03 02925	55	1	1951 03 02950
30	19	30	1	1951 03 03025	55	1	1951 03 03050
31	19	30	1	1951 03 03125	55	1	1951 03 03150
32	19	30	1	1951 03 03225	55	1	1951 03 03250
35	19	30	1	1951 03 03525	55	1	1951 03 03550
40	19	30	1	1951 03 04025	55	1	1951 03 04050
45	19	30	1	1951 03 04525	55	1	1951 03 04550
50	19	30	1	1951 03 05025	55	1	1951 03 05050
55	19	30	1	1951 03 05525	55	1	1951 03 05550
60	19	30	1	1951 03 06025	55	1	1951 03 06050

BC Kassetten / BC Boxes

Bezeichnung Description	Teile Pieces	Inhalt Content	Artikel-Nr. Part-No.
KBE 3 Co	4	Ø 14 · 18 · 22 x 30 mm + Auswerferstift / Ejector pin	1951 14 30003
KBE 6 Co	7	Ø 12 · 14 · 16 · 18 · 20 · 22 x 30 mm + Auswerferstift / Ejector pin	1951 13 10006



KB 3 HSS



KB 6 HSS

Kernbohrer HM, mit Weldonschaft (3/4")
Core drills TCT, with Weldon shank (3/4")



Code 1952 • 35 mm



Code 1952 • 55 mm



Hartmetall, CBN-geschliffen, passend in allen Säulen- und Magnetständerbohrmaschinen mit Weldonschaft-Aufnahme. Geeignet für Stahl (T-Träger, großformatige Bleche), rostfreien Stahl wie V2A und V4A, Bunt- und Leichtmetalle.

TCT, CBN-ground, suitable for all magnetic drill machines with Weldon attachment. For drilling steel (T-steel-girder, large-size sheets), stainless steel like AISI 304 + AISI 316, non-ferrous metal.

Ø d1 mm	Ø d2 mm	L 1 mm		Artikel-Nr. Part-No.	L 1 mm		Artikel-Nr. Part-No.
14	19	35	1	1952 03 01435	55	1	1952 03 01455
15	19	35	1	1952 03 01535	55	1	1952 03 01555
16	19	35	1	1952 03 01635	55	1	1952 03 01655
17	19	35	1	1952 03 01735	55	1	1952 03 01755
18	19	35	1	1952 03 01835	55	1	1952 03 01855
19	19	35	1	1952 03 01935	55	1	1952 03 01955
20	19	35	1	1952 03 02035	55	1	1952 03 02055
21	19	35	1	1952 03 02135	55	1	1952 03 02155
22	19	35	1	1952 03 02235	55	1	1952 03 02255
23	19	35	1	1952 03 02335	55	1	1952 03 02355
24	19	35	1	1952 03 02435	55	1	1952 03 02455
25	19	35	1	1952 03 02535	55	1	1952 03 02550
26	19	35	1	1952 03 02635	55	1	1952 03 02655
27	19	35	1	1952 03 02735	55	1	1952 03 02755
28	19	35	1	1952 03 02835	55	1	1952 03 02855
29	19	35	1	1952 03 02935	55	1	1952 03 02955
30	19	35	1	1952 03 03035	55	1	1952 03 03055
31	19	35	1	1952 03 03135	55	1	1952 03 03155
32	19	35	1	1952 03 03235	55	1	1952 03 03255
35	19	35	1	1952 03 03535	55	1	1952 03 03555
40	19	35	1	1952 03 04035	55	1	1952 03 04055
45	19	35	1	1952 03 04535	55	1	1952 03 04555
50	19	35	1	1952 03 05035	55	1	1952 03 05055
55	19	35	1	1952 03 05535	55	1	1952 03 05555
60	19	35	1	1952 03 06035	55	1	1952 03 06055

BC Runddose / BC Round-Box

Bezeichnung Description	Teile Pieces	Inhalt Content	Artikel-Nr. Part-No.
KB 3 HM	4	Ø 14 · 18 · 22 x 35 mm + Auswerferstift / Ejector pin	1952 14 30003



KB 3 HM

Auswerferstifte für Kernbohrer mit Weldonschaft (3/4") Ejector pins for core drills with Weldon shank (3/4")



Code 1955

Bezeichnung Description	Schnitttiefe Cutting depth	Ø Kernbohrer Ø Core drills		Artikel-Nr. Part-No.
HSS / HSS-E				
Auswerferstift für Kernbohrer / Ejector pin for core drills	30	12 – 60	1	1955 03 00025
Auswerferstift für Kernbohrer / Ejector pin for core drills	55	12 – 60	1	1955 03 00050
HM / TCT				
Auswerferstift für Kernbohrer / Ejector pin for core drills	35	14 – 17	1	1955 03 00350
Auswerferstift für Kernbohrer / Ejector pin for core drills	35	18 – 60	1	1955 03 00300
Auswerferstift für Kernbohrer / Ejector pin for core drills	55	14 – 17	1	1955 03 00050
Auswerferstift für Kernbohrer / Ejector pin for core drills	55	18 – 60	1	1955 03 00355

Industrieraufnahmen mit automatischer Innenschmierung Industrial holders with automatic internal lubrication



Code 1956

Bezeichnung Description	Konus Tapershank	Für Kernbohrer For core drills		Artikel-Nr. Part-No.
MK 2 / Weldon	MK / MT 2	Weldon 19 mm (3/4")	1	1956 03 00219
MK 3 / Weldon	MK / MT 3	Weldon 19 mm (3/4")	1	1956 03 00319

Adapter für Kernbohrer Adaptors for core drills



1957 03 00001



1957 03 00002



1957 03 00003

Code 1957

Bezeichnung Description	Für Kernbohrer For core drills		Artikel-Nr. Part-No.
Adapter / Adaptor Weldon 19 mm (3/4")	Fein M18x6 P 1,5	1	1957 03 00001
Adapter / Adaptor Weldon 19 mm (3/4")	Quick-IN	1	1957 03 00002
Adapter / Adaptor Fein Quick-IN	Weldon 19 mm (3/4")	1	1957 03 00003

Mehrbereichs-Lochsägen HM
Multigrade hole saws TCT



Solide konstruierte, einteilige (Schaft und Krone) Lochsäge mit Hartmetall Zahnschneiden. Empfohlene Schnitttiefe 15 mm, maximale Schnitttiefe 30 mm. Auswechselbarer Zentrierbohrer aus HSS. Geeignet für Stahl, Edelstahl, Buntmetalle, Kunststoff. Sehr gut geeignet zum Bohren von Rohren.

Solid constructed hole saw made of one piece (shank and crown) with carbide-tipped cutting teeth. Recommended cutting depth 15 mm, maximum possible cutting depth 30 mm. Exchangeable HSS pilot-drill. Suitable for steel, stainless steel, non-ferrous metals and plastic. Especially suitable for drilling into pipes.

Ø d1 mm	Ø d1 Zoll / inch	Ø d2 mm		Artikel-Nr. Part-No.
16	5/8"	13	1	1920 09 00160
18	-	13	1	1920 09 00180
20	-	13	1	1920 09 00200
21	-	13	1	1920 09 00210
22	-	13	1	1920 09 00220
25	-	13	1	1920 09 00250
26	-	13	1	1920 09 00260
27	1.1/16"	13	1	1920 09 00270
30	1.3/16"	13	1	1920 09 00300
32	1.1/4"	13	1	1920 09 00320
35	1.3/8"	13	1	1920 09 00350
37	1.7/16"	13	1	1920 09 00370
40	1.9/16"	13	1	1920 09 00400
45	-	13	1	1920 09 00450
47	1.7/8"	13	1	1920 09 00470
50	1.31/32"	13	1	1920 09 00500
51	2"	13	1	1920 09 00510
54	2.1/8"	13	1	1920 09 00540
55	-	13	1	1920 09 00550
60	2.3/8"	13	1	1920 09 00600
65	-	13	1	1920 09 00650
68	-	13	1	1920 09 00680
70	2.3/4"	13	1	1920 09 00700
75	-	13	1	1920 09 00750
80	-	13	1	1920 09 00800
85	-	13	1	1920 09 00850
90	-	13	1	1920 09 00900
95	3.3/4"	13	1	1920 09 00950
100	-	13	1	1920 09 01000



HM LOCHSÄGEN
TCT HOLESAWS

Zentrierbohrer HSS-G & Auswurf-Feder
Pilot-drill HSS-G & centrifugal spring

Bezeichnung Description	Ø mm		Artikel-Nr. Part-No.
Zentrierbohrer HSS-G / Pilot-drill HSS-G	6	1	1925 03 00600
Auswurf-Feder bis Ø 20 mm / Centrifugal spring up to Ø 20 mm	-	1	1925 03 00001
Auswurf-Feder ab Ø 21 mm / Centrifugal spring from Ø 21 mm	-	1	1925 03 00002









Code 1925



Code 1925

































































REIBAHLEN
REAMERS



	DIN	Qualität Quality	Form	Bezeichnung Description	Code	Seite Page
Reibahlen / Reamers						
		206	HSS	B	Handreibahlen Hand reamers	1670 161
	9	HSS	B	Hand-Kegelreibahlen Taper hand reamers	1671	162
	311	HSS		Nietloch-Reibahlen MK Taper shank bridge reamers	1672	163
	212	HSS-E Co5	B/D	Maschinen-Reibahlen Machine reamers	1673	164
	212	HSS-E Co5	C	NC Maschinen-Reibahlen NC Machine reamers	1674	165
	208	HSS-E Co5	B	Maschinen-Reibahlen MK Taper shank machine reamers	1675	166

Anwendungsempfehlung für Reibahlen

Application recommendation for reamers

						
DIN	206	9	311	212	212	208
Schneidstoff Cutting material	HSS	HSS	HSS	HSS-E Co5	HSS-E Co5	HSS-E Co5
Form	B	B	-	B/D	C	B
Drallwinkel Helix angle	7 – 9°	7°	25°	7 – 9°	45°	7°
Toleranz Tolerance	H7	H7	H11	H7	H7	H7
Schaft Shank	zyl. cyl.	zyl. cyl.	MK MT	zyl. cyl.	zyl. cyl.	MK MT
Bereich Range	4 – 30 mm	4 – 20 mm	10 – 30 mm	3 – 20 mm	3 – 20 mm	10 – 30 mm
Qualität Quality	★★★★★	★★★★★	★★★★★	★★★★★	★★★★★	★★★★★
Code	1670	1671	1672	1673	1674	1675
Seite Page	161	162	163	164	165	166
P	1.1					
	2.1					
	3.1					
	4.1					
	5.1					
M	1.1 – 2.1					
	3.1 – 4.1					
K	1.1 – 1.2					
	2.1 – 2.2					
	3.1 – 3.2					
	4.1 – 4.2					
N	1.1 – 1.3					
	1.4 – 1.5					
	1.6					
	2.1 – 2.2					
	2.3 – 2.6					
	4.1 – 4.2					
S	1.1 – 1.3					
	2.1 – 2.6					

 geeignet / suitable  bedingt geeignet / limited suitable

Handreibahlen DIN 206 Form B HSS
Hand reamers DIN 206 form B HSS

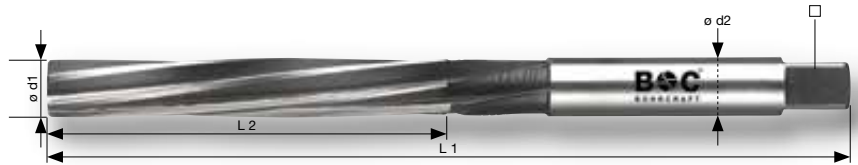

Code 1670

DIN 206
HSS
FORM B
45°
L 7-9°
R
Tol. H7

Code	P			M	K	N		S	
	1.1 - 2.1	3.1 - 4.1	5.1	1.1 - 4.1	1.1 - 2.2 / 4.1 - 4.2	1.1 - 1.3	2.1 - 2.6	4.1 - 4.2	1.1 - 2.6
1670	☉	☉			☉	☉		☉	

Zum Reiben von Durchgangsbohrungen in Eisen, NE-Metallen, harten und weichen Kunststoffen.

Nicht für die Bearbeitung von Sacklöchern geeignet.

For reaming of through holes in ferrous and non-ferrous materials, hard and soft plastic.

Not suitable for blind holes.

Ø d1 mm	L 1 mm	L 2 mm	Ø d2 mm	□ mm	Zähne Teeth	📐	Artikel-Nr. Part-No.
4	76	38	4	3,0	4	1	1670 03 00400
5	87	44	5	3,8	6	1	1670 03 00500
6	93	47	6	4,9	6	1	1670 03 00600
7	107	54	7	5,5	6	1	1670 03 00700
8	115	58	8	6,2	6	1	1670 03 00800
9	124	62	9	7,0	6	1	1670 03 00900
10	133	66	10	8,0	6	1	1670 03 01000
11	142	71	11	9,0	8	1	1670 03 01100
12	152	76	12	9,0	8	1	1670 03 01200
14	163	81	14	11,0	8	1	1670 03 01400
16	175	87	16	12,0	8	1	1670 03 01600
18	188	93	18	14,5	8	1	1670 03 01800
20	201	100	20	16,0	8	1	1670 03 02000
22	215	107	22	18,0	8	1	1670 03 02200
24	231	115	24	20,0	8	1	1670 03 02400
25	231	115	25	20,0	8	1	1670 03 02500
26	231	115	26	20,0	8	1	1670 03 02600
28	247	124	28	22,0	8	1	1670 03 02800
30	247	124	30	24,0	8	1	1670 03 03000

Hand-Kegelreibahlen DIN 9 Form B HSS

Taper hand reamers DIN 9 form B HSS

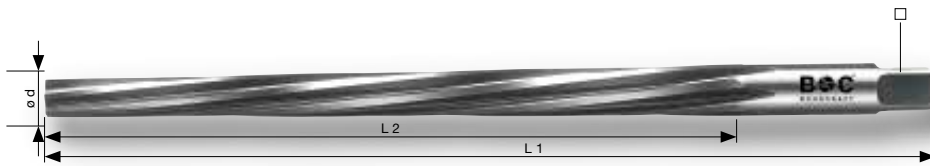

Code 1671



Code	P		M	K	N		S		
	1.1 - 2.1	3.1 - 4.1	5.1	1.1 - 4.1	1.1 - 2.2 / 4.1 - 4.2	1.1 - 1.3	2.1 - 2.6	4.1 - 4.2	1.1 - 2.6
1671	⊕	⊕			⊕	⊕		⊕	

Zum Reiben konischer Bohrungen für Kegelstifte in Eisen, NE-Metallen, harten und weichen Kunststoffen.

For reaming taper pin holes in ferrous and non-ferrous materials, hard and soft plastic.

Ø d mm	L 1 mm	L 2 mm	Ø min. mm	Ø max. mm	□ mm	Zähne Teeth	⏏	Artikel-Nr. Part-No.
4	93	67	3,9	5,25	3,8	4	1	1671 03 00400
5	100	73	4,9	6,36	4,9	6	1	1671 03 00500
6	135	105	5,9	8,00	6,2	6	1	1671 03 00600
8	180	145	7,9	10,80	8,0	6	1	1671 03 00800
10	215	175	8,9	13,40	10,0	6	1	1671 03 01000
12	255	210	11,8	16,00	11,0	6	1	1671 03 01200
16	280	230	15,8	20,40	14,5	8	1	1671 03 01600
20	310	250	19,8	24,80	18,0	8	1	1671 03 02000

Nietloch-Reibahlen DIN 311 HSS
Bridge reamers DIN 311 HSS

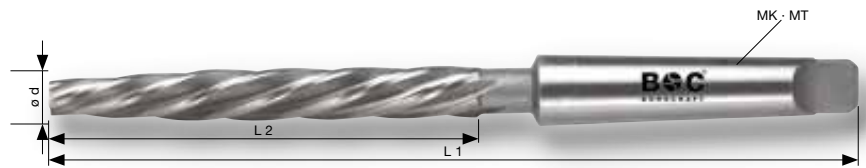

Code 1672



Code	P			M	K	N		S	
	1.1 - 2.1	3.1 - 4.1	5.1	1.1 - 4.1	1.1 - 2.2 / 4.1 - 4.2	1.1 - 1.3	2.1 - 2.6	4.1 - 4.2	1.1 - 2.6
1672	☉	☉			☉	☉	☉	☉	

Zum Korrigieren des Bohrungsversatzes übereinander angeordneter Blechteile auf den gewünschten Bohrungsdurchmesser (z.B. zum Vernieten oder Verschrauben).

For correction of the drill hole offset of superimposed plates to match the drill hole diameter required (e.g. when riveting or screwing).

Ø d mm	L 1 mm	L 2 mm	MK MT	Zähne Teeth	📏	Artikel-Nr. Part-No.
10	171	95	1	5	1	1672 03 01000
12	199	105	2	5	1	1672 03 01200
13	199	105	2	5	1	1672 03 01300
14	209	115	2	5	1	1672 03 01400
15	219	125	2	5	1	1672 03 01500
16	229	135	2	5	1	1672 03 01600
17	251	135	3	5	1	1672 03 01700
18	261	145	3	5	1	1672 03 01800
20	271	155	3	5	1	1672 03 02000
21	271	155	3	5	1	1672 03 02100
22	281	165	3	5	1	1672 03 02200
25	296	180	3	5	1	1672 03 02500
28	311	195	3	5	1	1672 03 02800
30	311	195	3	5	1	1672 03 03000

Maschinen-Reibahlen DIN 212 Form B/D HSS-E (Co5)
Machine-reamers DIN 212 form B/D HSS-E (Co5)



Code 1673



Code	P			M	K	N		S	
	1.1 - 2.1	3.1 - 4.1	5.1	1.1 - 4.1	1.1 - 2.2 / 4.1 - 4.2	1.1 - 1.3	2.1 - 2.6	4.1 - 4.2	1.1 - 2.6
1673	⊕	⊕		⊕	⊕	⊕	⊕	⊕	⊕

Zum Reiben von Durchgangsbohrungen in Eisen, NE-Metallen, harten und weichen Kunststoffen.

For reaming of through holes in ferrous and non-ferrous materials, hard and soft plastic.

Ø d1 mm	L 1 mm	L 2 mm	Ø d2 mm	Zähne Teeth		Artikel-Nr. Part-No.
3	61	15	3,0	4	1	1673 03 00300
4	75	19	4,0	4	1	1673 03 00400
5	86	23	5,0	6	1	1673 03 00500
6	93	26	6,0	6	1	1673 03 00600
7	109	30	7,0	6	1	1673 03 00700
8	117	32	8,0	6	1	1673 03 00800
9	125	36	9,0	6	1	1673 03 00900
10	133	38	10,0	6	1	1673 03 01000
11	142	41	10,0	8	1	1673 03 01100
12	151	44	10,0	8	1	1673 03 01200
13	151	44	10,0	8	1	1673 03 01300
14	160	47	12,5	8	1	1673 03 01400
15	162	50	12,5	8	1	1673 03 01500
16	170	52	12,5	8	1	1673 03 01600
17	175	54	14,0	8	1	1673 03 01700
18	182	56	14,0	8	1	1673 03 01800
19	189	58	16,0	8	1	1673 03 01900
20	195	60	16,0	8	1	1673 03 02000

NC Maschinen-Reibahlen DIN 212 Form C HSS-E (Co5)
NC Machine-reamers DIN 212 form C HSS-E (Co5)



Code 1674

DIN 212
HSS-E Co5
FORM C
L 45°
R
Tol. H7

Code	P			M	K	N			S
	1.1 - 2.1	3.1 - 4.1	5.1	1.1 - 4.1	1.1 - 2.2 / 4.1 - 4.2	1.1 - 1.3	2.1 - 2.6	4.1 - 4.2	1.1 - 2.6
1674	☉	☉		☉	☉	☉	☉	☉	☉

NC-gerechte Ausführung. Zum Reiben von Durchgangsbohrungen in Eisen, NE-Metallen, harten und weichen Kunststoffen.

Suitable for CNC-machines. For reaming of through holes in ferrous and non-ferrous materials, hard and soft plastic.

Ø d1 mm	L 1 mm	L 2 mm	Ø d2 mm	Zähne Teeth	📏	Artikel-Nr. Part-No.
3	61	15	3,0	6	1	1674 03 00300
4	75	19	4,0	6	1	1674 03 00400
5	86	23	5,0	6	1	1674 03 00500
6	93	26	6,0	6	1	1674 03 00600
7	109	30	7,0	6	1	1674 03 00700
8	117	32	8,0	6	1	1674 03 00800
9	125	36	9,0	6	1	1674 03 00900
10	133	38	10,0	6	1	1674 03 01000
11	142	41	10,0	8	1	1674 03 01100
12	151	44	10,0	8	1	1674 03 01200
13	151	44	10,0	8	1	1674 03 01300
14	160	47	12,5	8	1	1674 03 01400
16	170	52	12,5	8	1	1674 03 01600
18	182	56	14,0	8	1	1674 03 01800
20	195	60	16,0	10	1	1674 03 02000

Maschinen-Reibahlen DIN 208 Form B HSS-E (Co5)
Machine-reamers DIN 208 form B HSS-E (Co5)



Code 1675



Code	P			M	K	N		S	
	1.1 - 2.1	3.1 - 4.1	5.1	1.1 - 4.1	1.1 - 2.2 / 4.1 - 4.2	1.1 - 1.3	2.1 - 2.6	4.1 - 4.2	1.1 - 2.6
1675	⊕	⊕		⊕	⊕	⊕	⊕	⊕	⊕

Zum Reiben von Durchgangsbohrungen in Eisen, NE-Metallen, harten und weichen Kunststoffen.

For reaming of through holes in ferrous and non-ferrous materials, hard and soft plastic.

Ø d mm	L 1 mm	L 2 mm	MK MT	Zähne Teeth		Artikel-Nr. Part-No.
10	168	38	1	6	1	1675 03 01000
12	182	44	1	6	1	1675 03 01200
14	189	47	1	8	1	1675 03 01400
16	210	52	2	8	1	1675 03 01600
18	219	56	2	8	1	1675 03 01800
20	228	60	2	8	1	1675 03 02000
22	237	64	2	8	1	1675 03 02200
24	268	68	3	8	1	1675 03 02400
25	268	68	3	8	1	1675 03 02500
26	273	70	3	8	1	1675 03 02600
28	277	71	3	10	1	1675 03 02800
30	281	73	3	10	1	1675 03 03000



REIBAHLEN
REAMERS

NEW!





















Seite / Page 318



- Schneidpaste
- Schneidwachs
- Schneidgel
- Schneidöl
- Schneidschaum

























































- Cutting paste
- Cutting wax
- Cutting gel
- Cutting oil
- Cutting foam

GEWINDESCHNEIDWERKZEUGE
THREAD CUTTING TOOLS

		Gewinde Thread	Form	Qualität Quality	DIN	Code	Seite Page
Handgewindebohrer / Hand taps							
		M	-	HSS-G	352	4100	178 – 179
		M	-	HSS-E VAP	352	4110	180
		M (LH) links / left	-	HSS-G	352	4109	181
		MF	-	HSS-G	2181	4101	214 – 215
		G (BSP)	-	HSS-G	5157	4102	222
		BSW	-	HSS-G	~ 352	4103	228
		UNC	-	HSS-G	~ 352	4104	231
		UNF	-	HSS-G	~ 2181	4105	235
Schneideisen / Circular dies							
		M	B	HSS-G	EN 22568	4200 4201 (25x9)	182 – 183
		M	B	HSS-E VAP	EN 22568	4210	184
		M (LH) links / left	B	HSS-G	EN 22568	4209	185
		MF	B	HSS-G	EN 22568	4202	216 – 217
		G (BSP)	B	HSS-G	EN 24231	4203	223
		BSW	B	HSS-G	EN 22568	4205	229
		UNC	B	HSS-G	EN 22568	4206	232
		UNF	B	HSS-G	EN 22568	4207	236
Schneidmuttern / Hexagon die nuts							
		M	-	HSS-G	382	4204	186
		G (BSP)	-	HSS-G	382	4208	224

GEWINDESCHNEIDWERKZEUGE THREAD CUTTING TOOLS

		Gewinde Thread	Form	Qualität Quality	DIN	Code	Seite Page
Maschinengewindebohrer / Machine taps							
		M	B	HSS-G	371/376	4140, 4141	192 – 193
		M	C RSP 35° C SFT 35°	HSS-G	371/376	4150, 4151	192 – 193
		M	B	HSS-E	371/376	4142, 4143	194 – 195
		M	C RSP 35° C SFT 35°	HSS-E	371/376	4152, 4153	196 – 197
		M	B	HSS-E TiN	371/376	4147, 4148	194 – 195
		M	C RSP 35° C SFT 35°	HSS-E TiN	371/376	4157, 4158	196 – 197
		M (XL)	B	HSS-E	371/376	4161	207
		M (XL)	C RSP 35° C SFT 35°	HSS-E	371/376	4162	207
		M (LH) links / left	C	HSS-E	371/376	4159	208
		MF	B	HSS-E	374	4165	219
		MF	C RSP 35° C SFT 35°	HSS-E	374	4166	219
		G (BSP)	B	HSS-E	5156	4175	226
		G (BSP)	C RSP 35° C SFT 35°	HSS-E	5156	4176	226
		UNC	B	HSS-E	~ 371/376	4196	234
		UNC	C RSP 35° C SFT 35°	HSS-E	~ 371/376	4197	234
		UNF	B	HSS-E	~ 371/376	4198	238
		UNF	C RSP 35° C SFT 35°	HSS-E	~ 371/376	4199	238
		M	-	HSS-E	-	4172	209
		M	B	HSS-E PM	371/376	4169, 4170	200
		M	C RSP 40° C SFT 40°	HSS-E PM	371/376	4179, 4180	200
		M	B	HSS-E	371/376	4163, 4164	198
		M	C RSP 40° C SFT 40°	HSS-E	371/376	4167, 4168	199
		M	B	HSS-E TiN	371/376	4183, 4184	198
		M	C RSP 40° C SFT 40°	HSS-E TiN	371/376	4187, 4188	199
		M	B	HSS-E TiALN	371/376	4181, 4182	198
		M	C RSP 40° C SFT 40°	HSS-E TiALN	371/376	4185, 4186	199
		MF	C	HSS-E	374	4139	220
		G	C	HSS-E	5156	4247	227
		M	B	HSS-E	371/376	4173, 4174	202
		M	C RSP 40° C SFT 40°	HSS-E	371/376	4177, 4178	203
		M	B	HSS-E TiALN	371/376	4189, 4190	202
		M	C RSP 40° C SFT 40°	HSS-E TiALN	371/376	4191, 4192	203
		M	B	HSS-E VAP	371/376	4144, 4145	201
		M	C RSP 40° C SFT 40°	HSS-E VAP	371/376	4154, 4155	201
		MF	B	HSS-E VAP	374	4146	221

	Gewinde Thread	Form	Qualität Quality	DIN	Code	Seite Page	
		MF	C RSP 40° C SFT 40°	HSS-E VAP	374	4156	221
		M	C	HSS-E TiCN	371/376	4193	206
		M	C RSP 45° C SFT 45°	HSS-E	371/376	4149	204
		M	B-AZ	HSS-E	371/376	4240	205
Gewindeformer / Forming/Fluteless taps							
		M	D	HSS-E TiN	371/376	4243	212
		M	C	HSS-E TiN	371/376	4245	213
Einschnittgewindebohrer / Short machine taps							
		M	B	HSS-G	352	4120	187
		M	B	HSS-E	352	4125	188
		M	C	HSS-G	352	4121	189
		M	C	HSS-E	352	4111	190
		M (LH) links / left	C	HSS-G	352	4129	191
		MF	C	HSS-G	2181	4131	218
		G (BSP)	C	HSS-G	5157	4132	225
		BSW	C	HSS-G	~ 352	4133	230
		UNC	C	HSS-G	~ 352	4134	233
		UNF	C	HSS-G	~ 2181	4135	237
		NPT	C	HSS-G	BC Norm	4136	239
		PG	C	HSS-G	40432	4130	240
		M	C	HSS-G	-	4171	210
Maschinen-Muttergewindebohrer / Machine nut taps							
		M	-	HSS-G	357	4160	211
Verstellbare Windeisen / Adjustable tap wrenches							
					1814	4300	242
Schneideisenhalter / Die stocks							
					225	4400	424
Werkzeughalter mit Knarre / Tap wrenches with ratchet							
					BC Norm	4302	243
Gewindebohrerverlängerung / Extension sleeves							
					377	4500	243
Gewindefeilen / Thread restoring files							
					-	4501	241
Gewindeschablonen / Thread gauges							
					-	9651	241
Schraubenausdreher / Screw extractors							
				CV	-	9700	244
Hartmetall-Reißnadel / Steel scriber with carbide cutting point							
				HM TCT	-	9600	245

Lieferbare Ausführungen
Available versions

HSS G **800**
N/mm²



Hochleistungs-Schnellstahl zur Bearbeitung von gut zerspanbaren Werkstoffen bis 800 N/mm² Festigkeit.

High-Speed-Steel suitable for materials with tensile strength up to 800 N/mm² (22 HRC).

HSS-E Co5 **1000**
N/mm²



Hochleistungs-Schnellstahl mit 5 % Kobalt Anteil zur Bearbeitung von unlegierten und niedriglegierten Stählen. Höhere Warmhärtebeständigkeit und Verschleißfestigkeit.

High-Speed-Steel 5 % cobalt alloyed. Suitable for unalloyed and low-alloyed steel. Higher warm hardness resistance and wear resistance.

HSS-E Co5 **1000**
N/mm²



TiN-Beschichtung für höhere Oberflächenhärte und bessere Gleiteigenschaften. Dadurch Standzeiterhöhung sowie Erhöhung der Schnittgeschwindigkeiten möglich.

TiN-coating for higher surface hardness and reduced friction coefficient. This increases the tool life and allows higher cutting speed.

TiN

HSS-E PM **1200**
N/mm²



Sehr hohe Verschleißfestigkeit und Zähigkeit durch HSS-E PM. Mit HARDLUBE-Beschichtung für minimierte Oberflächenreibung sowie gleichmäßig gute Spanbildung und reibungslosen Spanfluss.

Made of HSS-E PM for very high wear-resistance and toughness. With HARDLUBE-Coating for low surface friction and consistent chip flow.

HARD LUBE 

HSS-E Co5 **1000**
N/mm²



Für den universellen Einsatz in allgemeinen Baustählen, Automatenstahl, unlegierten Einsatzstählen und Aluminiumlegierungen (kurzspanend).

For universal use in general structural steel, free-cutting steel, unalloyed case hardening steel and aluminium-alloys (short chipping).

UNI 

HSS-E Co5 **1000**
N/mm²



Für den universellen Einsatz in allgemeinen Baustählen, Automatenstahl und unlegierten Einsatzstählen. Zusätzlich mit TiN-Beschichtung zur Erhöhung der Standzeit.

For universal use in general structural steel, free-cutting steel and unalloyed case hardening steel. Additionally with TiN-coating to increase the tool life.

UNI **TiN**

HSS-E Co5 **1000**
N/mm²



Für den universellen Einsatz in allgemeinen Baustählen, Automatenstahl und unlegierten Einsatzstählen. Zusätzlich mit TiALN-Beschichtung zur Erhöhung der Standzeit.

For universal use in general structural steel, free-cutting steel and unalloyed case hardening steel. Additionally with TiALN-coating to increase the tool life.

UNI **TiALN**

HSS-E Co5 **1200**
N/mm²



Für den Einsatz in vergüteten und hitzebeständigen Stählen sowie Werkzeugstahl.

For use in tempered and heat-resistant steels as well as tool steel.

HD 

HSS-E Co5 **1200**
N/mm²



Für den Einsatz in vergüteten und hitzebeständigen Stählen sowie Werkzeugstahl. Mit TiALN-Beschichtung.

For use in tempered and heat-resistant steels as well as tool steel. With TiALN-coating.

HD **TiALN**

TECHNISCHE DETAILS
TECHNICAL DETAILS

Lieferbare Ausführungen
Available versions

HSS-E
Co5

1000
N/mm²

VA INOX

Blauring



Spezielle Schneidengeometrie und vaporisierte Oberfläche, besonders für die Bearbeitung von VA- und rostfreien Stählen geeignet.

Special cutting edge geometry and vap. surface, especially suitable for stainless steel like AISI 304 and 316.

HSS-E
Co5

TiCN

GG

Weißring



Gewindebohrer speziell für die Bearbeitung von Grauguss (GG).
Machine-Tap especially suitable for grey cast iron (GG).

HSS-E
Co5

450
N/mm²

ALU

Gelbring



Mit 2 breiten Spiralnuten und starkem Drall. Besonders geeignet für die Bearbeitung von Aluminium und Aluminiumlegierungen sowie weichen Kunststoffen (langspanend).

With 2 wide spiral flutes 45°. Especially suitable for aluminium and aluminium-alloys as well as thermoplastics (long chipping).

B

3 x D



4 – 5 Gang Anschnitt mit Schälanschnitt für Durchgangsloch.
4 – 5 threads lead with spiral point (gun nose) for through holes.

B-AZ

3 x D



4 – 5 Gang Schälanschnitt mit ausgesetzten Zähnen, für Durchgangsloch.
4 - 5 threads lead with spiral point (gun nose) and interrupted thread for through holes.

C

1,5 x D

1,5 x D



2 – 3 Gang Anschnitt für Durchgangs- und Sackloch.
2 – 3 threads lead for through/blind holes.

FORM C

35°

2,5 x D

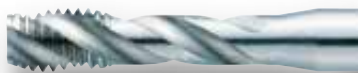

2 – 3 Gang Anschnitt mit 35° Rechtsspirale für Sackloch.
2 – 3 threads lead with 35° spiral flute for blind holes.

FORM C

40°

2,5 x D



2 – 3 Gang Anschnitt mit 40° Rechtsspirale für Sackloch.
2 – 3 threads lead with 40° spiral flute for blind holes.

FORM C

45°

2,5 x D



2 – 3 Gang Anschnitt mit 45° Rechtsspirale für Sackloch.
2 – 3 threads lead with 45° spiral flute for blind holes.



TECHNISCHE DETAILS
TECHNICAL DETAILS

Anwendungsempfehlung für Maschinengewindebohrer

Application recommendation for machine taps

Gewinde Thread	M	M	M	M	M	M	M	M	M
Typ Type	-	-	-	-	-	-	UNI	UNI	UNI
DIN	371 / 376	371 / 376	371 / 376	371 / 376	371 / 376	371 / 376	371 / 376	371 / 376	371 / 376
Schneidstoff Cutting material	HSS	HSS	HSS-E	HSS-E	HSS-E	HSS-E	HSS-E	HSS-E	HSS-E
Beschichtung Coating	-	-	-	TiN	-	TiN	-	TiN	TiAlN
Nuten Flutes	gerade straight	35°	gerade straight	gerade straight	35°	35°	gerade straight	gerade straight	gerade straight
Anschnitt Chamfer	B	C	B	B	C	B	B	B	B
Gewindetiefe Thread depth	3xD	2,5xD	3xD	3xD	2,5xD	2,5xD	3xD	3xD	3xD
Bereich Range	M3 – M24	M3 – M24	M2 – M36	M3 – M24	M2 – M36	M3 – M24	M2 – M24	M3 – M24	M3 – M24
Qualität Quality	★★★★	★★★★	★★★★★	★★★★★	★★★★★	★★★★★	★★★★★★	★★★★★★	★★★★★★
Code	4140 4141	4150 4151	4142 4143	4147 4148	4152 4153	4157 4158	4163 4164	4183 4184	4181 4182
Seite Page	192 – 193	192 – 193	194 – 195	194 – 195	196 – 197	196 – 197	198	198	198
P	1.1								
	2.1								
	3.1								
	4.1								
	5.1								
M	1.1 – 2.1								
	3.1 – 4.1								
K	1.1 – 1.2								
	2.1 – 2.2								
	3.1 – 3.2								
	4.1 – 4.2								
N	1.1 – 1.3								
	1.4 – 1.5								
	1.6								
	2.1 – 2.2								
	2.3 – 2.5								
	4.2								

geeignet / suitable bedingt geeignet / limited suitable

 TECHNISCHE DETAILS
 TECHNICAL DETAILS

Anwendungsempfehlung für Maschinengewindebohrer Application recommendation for machine taps

M	M	M	M	M	M	M	M	M	M	M
UNI	UNI	UNI	UNI	UNI	INOX	INOX	HD	HD	HD	HD
371 / 376	371 / 376	371 / 376	371 / 376	371 / 376	371 / 376	371 / 376	371 / 376	371 / 376	371 / 376	371 / 376
HSS-E	HSS-E	HSS-E	HSS-E PM	HSS-E PM	HSS-E	HSS-E	HSS-E	HSS-E	HSS-E	HSS-E
-	TiN	TiALN	Hardlube	Hardlube	VAP	VAP	-	TiALN	-	TiALN
40°	40°	40°	gerade straight	40°	gerade straight	40°	gerade straight	gerade straight	40°	40°
C	C	C	B	C	B	C	B	B	C	C
2,5xD	2,5xD	2,5xD	3xD	2,5xD	3xD	2,5xD	3xD	3xD	2,5xD	3xD
M3 – M24	M3 – M24	M3 – M24	M3 – M24	M3 – M24	M3 – M24	M3 – M24	M3 – M24	M3 – M24	M3 – M24	M3 – M24
★★★★★	★★★★★	★★★★★	★★★★★	★★★★★	★★★★★	★★★★★	★★★★★	★★★★★	★★★★★	★★★★★
4167 4168	4187 4188	4185 4186	4169 4170	4179 4180	4144 4145	4154 4155	4173 4174	4189 4190	4177 4178	4191 4192
199	199	199	200	200	201	201	202	202	203	203

geeignet / suitable bedingt geeignet / limited suitable



TECHNISCHE DETAILS
TECHNICAL DETAILS

Anwendungsempfehlung für Maschinengewindebohrer

Application recommendation for machine taps































































































Gewinde Thread	M	M	M	M	M	M - LH	M	M	MF
Typ Type	ALU	AZ	GG	XL	XL	LH	-	Kombi	-
DIN	371 / 376	371 / 376	371 / 376	371 / 376	371 / 376	371 / 376	357	-	374
Schneidstoff Cutting material	HSS-E	HSS-E	HSS-E	HSS-E	HSS-E	HSS-E	HSS	HSS-E	HSS-E
Beschichtung Coating	-	-	TiCN	-	-	-	-	-	-
Nuten Flutes	45°	gerade straight	gerade straight	gerade straight	35°	gerade straight	gerade straight	-	gerade straight
Anschnitt Chamfer	C	B-AZ	C	B	C	C	-	-	B
Gewindetiefe Thread depth	2,5xD	3xD	3xD	3xD	2,5xD	1,5xD	1xD	2xD	3xD
Bereich Range	M3 – M20	M3 – M12	M3 – M24	M3 – M12	M3 – M12	M3 – M24	M3 – M16	M3 – M12	M3x0,35 – 30x2
Qualität Quality	★★★★★	★★★★★	★★★★★	★★★★★	★★★★★	★★★★★	★★★★	★★★★	★★★★★
Code	4149	4240	4193	4161	4162	4159	4160	4172	4165
Seite Page	204	205	206	207	207	208	211	209	219
P	1.1								
	2.1								
	3.1								
	4.1								
	5.1								
M	1.1 – 2.1								
	3.1 – 4.1								
K	1.1 – 1.2								
	2.1 – 2.2								
	3.1 – 3.2								
	4.1 – 4.2								
N	1.1 – 1.3								
	1.4 – 1.5								
	1.6								
	2.1 – 2.2								
	2.3 – 2.5								
	4.2								



geeignet / suitable bedingt geeignet / limited suitable



TECHNISCHE DETAILS
TECHNICAL DETAILS

Anwendungsempfehlung für Maschinengewindebohrer Application recommendation for machine taps

										
MF	MF	MF	MF	G	G	G	UNC	UNC	UNF	UNF
-	UNI	INOX	INOX	-	-	UNI	-	-	-	-
374	374	374	374	5156	5156	5156	371 / 376	371 / 376	371 / 376	371 / 376
HSS-E	HSS-E	HSS-E	HSS-E	HSS-E	HSS-E	HSS-E	HSS-E	HSS-E	HSS-E	HSS-E
-	-	VAP	VAP	-	-	-	-	-	-	-
35°	gerade straight	gerade straight	40°	gerade straight	35°	gerade straight	gerade straight	35°	gerade straight	35°
C	C	B	C	B	C	C	B	C	B	C
2,5xD	1,5xD	3xD	2,5xD	3xD	2,5xD	1,5xD	3xD	2,5xD	3xD	2,5xD
M3x0,35 – 30x2	M6x0,75 – 30x1,5	M6x0,75 – 20x1,5	M6x0,75 – 20x1,5	G 1/8" – 1"	G 1/8" – 1"	G 1/8" – 1"	1/4" – 1"	1/4" – 1"	1/4" – 1"	1/4" – 1"
★★★★★	★★★★★	★★★★★	★★★★★	★★★★★	★★★★★	★★★★★	★★★★★	★★★★★	★★★★★	★★★★★
4166	4139	4146	4156	4175	4176	4247	4196	4197	4198	4199
219	220	221	221	226	226	220	234	234	238	238
										
										
										
										
										
										
										
										
										
										
										

 geeignet / suitable  bedingt geeignet / limited suitable



Code **4100** Nr. 1



Nr. 2



Nr. 3



Für den allgemeinen Einsatz in gut zerspanbaren Werkstoffen mit einer Zugfestigkeit bis 800 N/mm².

- Zum Schneiden von metrischen ISO-Gewinden DIN 13
- Für Durchgangs- und Sackloch
- Nr. 1 Vorschneider 6 – 8 Gang Anschnitt
- Nr. 2 Mittelschneider 4 – 5 Gang Anschnitt
- Nr. 3 Fertigschneider 2 – 3 Gang Anschnitt

For general use in good machinable materials up to 800 N/mm² (22,5 HRC) tensile strength.

- For cutting metric ISO-Thread DIN 13
- For through- and blind holes
- No. 1 Rougher 6 – 8 threads lead
- No. 2 Intermediate 4 – 5 threads lead
- No. 3 Finisher 2 – 3 threads lead

Ø d1 mm		L 1 mm	L 2 mm	Ø d2 mm			Satz / Set	Nr. 1	Nr. 2	Nr. 3
M 1 x 0,25	0,75	32	5,5	2,8	2,1	1	4100 11 00100	4100 11 10100	4100 11 20100	4100 11 30100
M 1,1 x 0,25	0,85	32	5,5	2,8	2,1	1	4100 11 00110	4100 11 10110	4100 11 20110	4100 11 30110
M 1,2 x 0,25	0,95	32	5,5	2,8	2,1	1	4100 11 00120	4100 11 10120	4100 11 20120	4100 11 30120
M 1,4 x 0,30	1,10	32	7,0	2,8	2,1	1	4100 11 00140	4100 11 10140	4100 11 20140	4100 11 30140
M 1,6 x 0,35	1,25	32	8,0	2,8	2,1	1	4100 11 00160	4100 11 10160	4100 11 20160	4100 11 30160
M 1,7 x 0,35	1,30	32	8,0	2,8	2,1	1	4100 11 00170	4100 11 10170	4100 11 20170	4100 11 30170
M 1,8 x 0,35	1,45	32	8,0	2,8	2,1	1	4100 11 00180	4100 11 10180	4100 11 20180	4100 11 30180
M 2 x 0,4	1,60	36	8,0	2,8	2,1	1	4100 11 00200	4100 11 10200	4100 11 20200	4100 11 30200
M 2,2 x 0,45	1,75	36	9,0	2,8	2,1	1	4100 11 00220	4100 11 10220	4100 11 20220	4100 11 30220
M 2,3 x 0,4	1,90	36	9,0	2,8	2,1	1	4100 11 00230	4100 11 10230	4100 11 20230	4100 11 30230
M 2,5 x 0,45	2,05	40	9,0	2,8	2,1	1	4100 11 00250	4100 11 10250	4100 11 20250	4100 11 30250
M 2,6 x 0,45	2,10	40	9,0	2,8	2,1	1	4100 11 00260	4100 11 10260	4100 11 20260	4100 11 30260
M 3 x 0,5	2,50	40	11,0	3,5	2,7	1	4100 11 00300	4100 11 10300	4100 11 20300	4100 11 30300
M 3,5 x 0,6	2,90	45	13,0	4,0	3,0	1	4100 11 00350	4100 11 10350	4100 11 20350	4100 11 30350
M 4 x 0,7	3,30	45	13,0	4,5	3,4	1	4100 11 00400	4100 11 10400	4100 11 20400	4100 11 30400
M 5 x 0,8	4,20	50	16,0	6,0	4,9	1	4100 11 00500	4100 11 10500	4100 11 20500	4100 11 30500
M 6 x 1	5,00	50	19,0	6,0	4,9	1	4100 11 00600	4100 11 10600	4100 11 20600	4100 11 30600
M 7 x 1	6,00	50	19,0	6,0	4,9	1	4100 11 00700	4100 11 10700	4100 11 20700	4100 11 30700
M 8 x 1,25	6,80	56	22,0	6,0	4,9	1	4100 11 00800	4100 11 10800	4100 11 20800	4100 11 30800
M 9 x 1,25	7,80	63	22,0	7,0	5,5	1	4100 11 00900	4100 11 10900	4100 11 20900	4100 11 30900
M 10 x 1,5	8,50	70	24,0	7,0	5,5	1	4100 11 01000	4100 11 11000	4100 11 21000	4100 11 31000
M 12 x 1,75	10,20	75	29,0	9,0	7,0	1	4100 11 01200	4100 11 11200	4100 11 21200	4100 11 31200
M 14 x 2	12,00	80	30,0	11,0	9,0	1	4100 11 01400	4100 11 11400	4100 11 21400	4100 11 31400
M 16 x 2	14,00	80	32,0	12,0	9,0	1	4100 11 01600	4100 11 11600	4100 11 21600	4100 11 31600
M 18 x 2,5	15,50	95	40,0	14,0	11,0	1	4100 11 01800	4100 11 11800	4100 11 21800	4100 11 31800
M 20 x 2,5	17,50	95	40,0	16,0	12,0	1	4100 11 02000	4100 11 12000	4100 11 22000	4100 11 32000
M 22 x 2,5	19,50	100	40,0	18,0	14,5	1	4100 11 02200	4100 11 12200	4100 11 22200	4100 11 32200
M 24 x 3	21,00	110	50,0	18,0	14,5	1	4100 11 02400	4100 11 12400	4100 11 22400	4100 11 32400
M 27 x 3	24,00	110	50,0	20,0	16,0	1	4100 11 02700	4100 11 12700	4100 11 22700	4100 11 32700
M 30 x 3,5	26,50	125	56,0	22,0	18,0	1	4100 11 03000	4100 11 13000	4100 11 23000	4100 11 33000
M 33 x 3,5	29,50	125	56,0	25,0	20,0	1	4100 11 03300	4100 11 13300	4100 11 23300	4100 11 33300
M 36 x 4	32,00	150	63,0	28,0	22,0	1	4100 11 03600	4100 11 13600	4100 11 23600	4100 11 33600
M 39 x 4	35,00	150	63,0	32,0	24,0	1	4100 11 03900	4100 11 13900	4100 11 23900	4100 11 33900
M 42 x 4,5	37,50	150	63,0	32,0	24,0	1	4100 11 04200	4100 11 14200	4100 11 24200	4100 11 34200
M 45 x 4,5	40,50	160	70,0	36,0	29,0	1	4100 11 04500	4100 11 14500	4100 11 24500	4100 11 34500
M 48 x 5	43,00	180	75,0	36,0	29,0	1	4100 11 04800	4100 11 14800	4100 11 24800	4100 11 34800
M 52 x 5	47,00	180	75,0	40,0	32,0	1	4100 11 05200	4100 11 15200	4100 11 25200	4100 11 35200



M

HANDGEWINDEBOHRER
HAND TAPS



BC ABS-Boxen / BC ABS-Boxes

Bezeichnung Description	Teile Pieces	Inhalt Content	Artikel-Nr. Part-No.
G 12-K	21 M3 – M12	HGB-Sätze 3-tlg. / <i>Hand-tap sets 3 pcs.</i> DIN 352 HSS · M3 · M4 · M5 · M6 · M8 · M10 · M12	4100 13 30021
GK 12-K	28 M3 – M12	HGB-Sätze 3-tlg. / <i>Hand-tap sets 3 pcs.</i> DIN 352 HSS · M3 · M4 · M5 · M6 · M8 · M10 · M12 HSS-Bohrer / <i>Drills</i> DIN 338 Ø 2,5 · 3,3 · 4,2 · 5,0 · 6,8 · 8,5 · 10,2 mm	4100 13 30028



BC Industrie-Kassetten / BC Metal-Boxes

Bezeichnung Description	Teile Pieces	Inhalt Content	Artikel-Nr. Part-No.
G 12	21 M3 – M12	HGB-Sätze 3-tlg. / <i>Hand-tap sets 3 pcs.</i> DIN 352 HSS · M3 · M4 · M5 · M6 · M8 · M10 · M12	4100 14 10021
GK 12	28 M3 – M12	HGB-Sätze 3-tlg. / <i>Hand-tap sets 3 pcs.</i> DIN 352 HSS · M3 · M4 · M5 · M6 · M8 · M10 · M12 HSS-Bohrer / <i>Drills</i> DIN 338 Ø 2,5 · 3,3 · 4,2 · 5,0 · 6,8 · 8,5 · 10,2 mm	4100 14 10028
GS 25	31 M3 – M12 (25 x 9)	HGB-Sätze 3-tlg. / <i>Hand-tap sets 3 pcs.</i> DIN 352 HSS + Schneideisen / <i>Circular dies</i> , HSS (Ø 25 mm), M3 · M4 · M5 · M6 · M8 · M10 · M12 Halter / <i>Holder</i> DIN 225, 25 x 9 Windeisen / <i>Tap wrench</i> DIN 1814 Gr. 1,5 Schraubendreher / <i>Screwdriver</i>	6000 14 10025
GW 12	44 M3 – M12	HGB-Sätze 3-tlg. / <i>Hand-tap sets 3 pcs.</i> DIN 352 HSS + Schneideisen / <i>Circular dies</i> , HSS, M3 · M4 · M5 · M6 · M8 · M10 · M12 Halter / <i>Holder</i> DIN 225 20 x 5 · 20 x 7 · 25 x 9 · 30 x 11 · 38 x 14 Windeisen / <i>Tap wrench</i> DIN 1814 Gr. 1 + 2 Gewindeschablone / <i>Gauge</i> Schraubendreher / <i>Screwdriver</i> Kernlochbohrer / <i>Core hole drills</i> DIN 338 HSS-G Ø 2,5 · 3,3 · 4,2 · 5,0 · 6,8 · 8,5 · 10,2 mm	6000 14 10044
GW 20	54 M3 – M20	HGB-Sätze 3-tlg. / <i>Hand-tap sets 3 pcs.</i> DIN 352 HSS + Schneideisen / <i>Circular dies</i> , HSS, M3 · M4 · M5 · M6 · M8 · M10 · M12 · M14 · M16 · M18 · M20 Halter / <i>Holder</i> DIN 225 20 x 5 · 20 x 7 · 25 x 9 · 30 x 11 · 38 x 14 · 45 x 18 Windeisen / <i>Tap wrenches</i> DIN 1814 Gr. 1 + 3 Gewindeschablone / <i>Gauge</i> Schraubendreher / <i>Screwdriver</i>	6000 14 10054



BC Holzkassetten / BC Wooden-Boxes

Bezeichnung Description	Teile Pieces	Inhalt Content	Artikel-Nr. Part-No.
GWH 20	52 M3 – M20	HGB-Sätze 3-tlg. / <i>Hand-tap sets 3 pcs.</i> , DIN 352 HSS + Schneideisen / <i>Circular dies</i> , HSS, M3 · M4 · M5 · M6 · M8 · M10 · M12 · M14 · M16 · M18 · M20, Halter / <i>Holder</i> s DIN 225 20 x 5 · 20 x 7 · 25 x 9 · 30 x 11 · 38 x 14 · 45 x 18 Windeisen / <i>Tap wrenches</i> DIN 1814 Gr. 1 + 3	6000 14 50052
GWH 24	62 M3 – M24	HGB-Sätze 3-tlg. / <i>Hand-tap sets 3 pcs.</i> , DIN 352 HSS + Schneideisen / <i>Circular dies</i> , HSS, M3 · M4 · M5 · M6 · M8 · M10 · M12 · M14 · M16 · M18 · M20 · M22 · M24, Halter / <i>Holder</i> s DIN 225 20 x 5 · 20 x 7 · 25 x 9 · 30 x 11 · 38 x 14 · 45 x 18 · 55 x 22 Windeisen / <i>Tap wrenches</i> DIN 1814 Gr. 0 · 2 · 4	6000 14 50062



M Handgewindebohrer DIN 352 HSS-E (Co5) VAP

Hand taps DIN 352 HSS-E (Co5) VAP

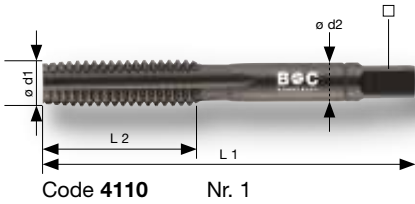

Code 4110

Nr. 1



Nr. 2



Nr. 3

M	DIN 352	HSS-E Co5	VAP	VA INOX	ISO2 6H	60°	1000 N/mm²
----------	----------------	------------------	------------	----------------	----------------	------------	-------------------

- Zum Schneiden von metrischen ISO-Gewinden DIN 13
- Für Durchgangs- und Sackloch
- VA- und rostfreie Stähle
- Nr. 1 Vorschneider 6 – 8 Gang Anschnitt
- Nr. 2 Mittelschneider 4 – 5 Gang Anschnitt
- Nr. 3 Fertigschneider 2 – 3 Gang Anschnitt

- For cutting metric ISO-Thread DIN 13
- For through- and blind holes
- Stainless steel
- No. 1 Rougher 6 – 8 threads lead
- No. 2 Intermediate 4 – 5 threads lead
- No. 3 Finisher 2 – 3 threads lead

Ø d1 mm		L 1 mm	L 2 mm	Ø d2 mm			Satz / Set	Nr. 1	Nr. 2	Nr. 3
M 3 x 0,5	2,5	40	11	3,5	2,7	1	4110 11 00300	4110 11 10300	4110 11 20300	4110 11 30300
M 4 x 0,7	3,3	45	13	4,5	3,4	1	4110 11 00400	4110 11 10400	4110 11 20400	4110 11 30400
M 5 x 0,8	4,2	50	16	6,0	4,9	1	4110 11 00500	4110 11 10500	4110 11 20500	4110 11 30500
M 6 x 1	5,0	50	19	6,0	4,9	1	4110 11 00600	4110 11 10600	4110 11 20600	4110 11 30600
M 8 x 1,25	6,8	56	22	6,0	4,9	1	4110 11 00800	4110 11 10800	4110 11 20800	4110 11 30800
M 10 x 1,5	8,5	70	24	7,0	5,5	1	4110 11 01000	4110 11 11000	4110 11 21000	4110 11 31000
M 12 x 1,75	10,2	75	29	9,0	7,0	1	4110 11 01200	4110 11 11200	4110 11 21200	4110 11 31200
M 14 x 2	12,0	80	30	11,0	9,0	1	4110 11 01400	4110 11 11400	4110 11 21400	4110 11 31400
M 16 x 2	14,0	80	32	12,0	9,0	1	4110 11 01600	4110 11 11600	4110 11 21600	4110 11 31600
M 18 x 2,5	15,5	95	40	14,0	11,0	1	4110 11 01800	4110 11 11800	4110 11 21800	4110 11 31800
M 20 x 2,5	17,5	95	40	16,0	12,0	1	4110 11 02000	4110 11 12000	4110 11 22000	4110 11 32000

BC ABS-Boxen / BC ABS-Boxes

Bezeichnung Description	Teile Pieces	Inhalt Content	Artikel-Nr. Part-No.
GE 12-K	21 M3 – M12	HGB-Sätze 3-tlg. / Hand-tap sets 3 pcs. DIN 352 HSS-E VAP M3 · M4 · M5 · M6 · M8 · M10 · M12	4110 13 30021
GKE 12-K	28 M3 – M12	HGB-Sätze 3-tlg. / Hand-tap sets 3 pcs. DIN 352 HSS-E VAP M3 · M4 · M5 · M6 · M8 · M10 · M12 HSS-E Bohrer / Drills DIN 338 Ø 2,5 · 3,3 · 4,2 · 5,0 · 6,8 · 8,5 · 10,2 mm	4110 13 30028



BC Industrie-Kassetten / BC Metal-Boxes

Bezeichnung Description	Teile Pieces	Inhalt Content	Artikel-Nr. Part-No.
GWE 12 P-Plus	44 M3 – M12	HGB-Sätze 3-tlg. / Hand-tap sets 3 pcs. DIN 352 + Schneideisen / Circular dies DIN EN 22568 HSS-E VAP M3 · M4 · M5 · M6 · M8 · M10 · M12 Halter / Holder DIN 225 20 x 5 · 20 x 7 · 25 x 9 · 30 x 11 · 38 x 14 Windeisen / Tap-Wrench DIN 1814 Gr. 1 + 2 Gewindeschablone / Gauge Schraubendreher / Screwdriver Kernlochbohrer / Core Hole Drills DIN 338 HSS-E Ø 2,5 · 3,3 · 4,2 · 5,0 · 6,8 · 8,5 · 10,2 mm	6001 14 10044
GWE 20 P-Plus	54 M3 – M20	HGB-Sätze 3-tlg. / Hand-tap sets 3 pcs. DIN 352 + Schneideisen / Circular dies DIN EN 22568 HSS-E VAP · M3 · M4 · M5 · M6 · M8 · M10 · M12 · M14 · M16 · M18 · M20 Halter / Holder DIN 225 20 x 5 · 20 x 7 · 25 x 9 · 30 x 11 · 38 x 14 · 45 x 18 Windeisen / Tap wrenches DIN 1814 Gr. 1 + 3 Gewindeschablone / Gauge Schraubendreher / Screwdriver	6001 14 10054



M
HANDGEWINDEBOHRER
HAND TAPS

Handgewindebohrer LINKS DIN 352 HSS-G | M

Hand taps LEFT HAND DIN 352 HSS-G | M



Code 4109 Nr. 1



Nr. 2



Nr. 3



Für den allgemeinen Einsatz in gut zerspanbaren Werkstoffen mit einer Zugfestigkeit bis 800 N/mm².

- Zum Schneiden von metrischen ISO-Gewinden DIN 13
- Für Durchgangs- und Sackloch
- Nr. 1 Vorschneider 6 – 8 Gang Anschnitt
- Nr. 2 Mittelschneider 4 – 5 Gang Anschnitt
- Nr. 3 Fertigschneider 2 – 3 Gang Anschnitt

For general use in good machinable materials up to 800 N/mm² (22,5 HRC) tensile strength.

- For cutting metric ISO-Thread DIN 13
- For through- and blind holes
- No. 1 Rougher 6 – 8 threads lead
- No. 2 Intermediate 4 – 5 threads lead
- No. 3 Finisher 2 – 3 threads lead

Ø d1 mm		L 1 mm	L 2 mm	Ø d2 mm			Satz / Set	Nr. 1	Nr. 2	Nr. 3
M 3 x 0,5	2,5	40	11	3,5	2,7	1	4109 11 00300	4109 11 10300	4109 11 20300	4109 11 30300
M 4 x 0,7	3,3	45	13	4,5	3,4	1	4109 11 00400	4109 11 10400	4109 11 20400	4109 11 30400
M 5 x 0,8	4,2	50	16	6,0	4,9	1	4109 11 00500	4109 11 10500	4109 11 20500	4109 11 30500
M 6 x 1	5,0	50	19	6,0	4,9	1	4109 11 00600	4109 11 10600	4109 11 20600	4109 11 30600
M 8 x 1,25	6,8	56	22	6,0	4,9	1	4109 11 00800	4109 11 10800	4109 11 20800	4109 11 30800
M 10 x 1,5	8,5	70	24	7,0	5,5	1	4109 11 01000	4109 11 11000	4109 11 21000	4109 11 31000
M 12 x 1,75	10,2	75	29	9,0	7,0	1	4109 11 01200	4109 11 11200	4109 11 21200	4109 11 31200
M 14 x 2	12,0	80	30	11,0	9,0	1	4109 11 01400	4109 11 11400	4109 11 21400	4109 11 31400
M 16 x 2	14,0	80	32	12,0	9,0	1	4109 11 01600	4109 11 11600	4109 11 21600	4109 11 31600
M 18 x 2,5	15,5	95	40	14,0	11,0	1	4109 11 01800	4109 11 11800	4109 11 21800	4109 11 31800
M 20 x 2,5	17,5	95	40	16,0	12,0	1	4109 11 02000	4109 11 12000	4109 11 22000	4109 11 32000
M 22 x 2,5	19,5	100	40	18,0	14,5	1	4109 11 02200	4109 11 12200	4109 11 22200	4109 11 32200
M 24 x 3	21,0	110	50	18,0	14,5	1	4109 11 02400	4109 11 12400	4109 11 22400	4109 11 32400

BC ABS-Box / BC ABS-Box

Bezeichnung Description	Teile Pieces	Inhalt Content	Artikel-Nr. Part-No.
GK 12-K LH	28 M3 – M12	HGB-Sätze 3-tlg. / Hand-tap sets 3 pcs. DIN 352 HSS-G · M3 · M4 · M5 · M6 · M8 · M10 · M12 HSS-G Bohrer / HSS-drills DIN 338, Typ N Ø 2,5 · 3,3 · 4,2 · 5,0 · 6,8 · 8,5 · 10,2 mm	4109 13 30028



BC Industrie-Kassetten / BC Metal-Boxes

Bezeichnung Description	Teile Pieces	Inhalt Content	Artikel-Nr. Part-No.
GW 12 LH	44 M3 – M12	HGB-Sätze 3-tlg. / Hand-tap sets 3 pcs. DIN 352 HSS-G + Schneideisen / Circular dies HSS-G, M3 · M4 · M5 · M6 · M8 · M10 · M12 Halter / Holder DIN 225 20 x 5 · 20 x 7 · 25 x 9 · 30 x 11 · 38 x 14 Windeisen / Tap-Wrench DIN 1814 Gr. 1 + 2 Gewindeschablone / Gauge Schraubendreher / Screwdriver Kernlochbohrer / Core Hole Drills DIN 338 HSS-G Ø 2,5 · 3,3 · 4,2 · 5,0 · 6,8 · 8,5 · 10,2 mm	6000 14 20044
GW 20 LH	54 M3 – M20	HGB-Sätze 3-tlg. / Hand-tap sets 3 pcs. DIN 352 HSS-G + Schneideisen / Circular dies HSS-G, M3 · M4 · M5 · M6 · M8 · M10 · M12 · M14 · M16 · M18 · M20 Halter / Holder DIN 225 20 x 5 · 20 x 7 · 25 x 9 · 30 x 11 · 38 x 14 · 45 x 18 Windeisen / Tap wrenches DIN 1814 Gr. 1 + 3 Gewindeschablone / Gauge Schraubendreher / Screwdriver	6000 14 20054



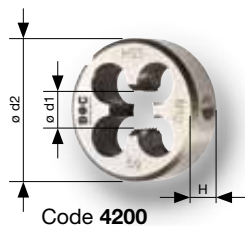

Für den allgemeinen Einsatz in gut zerspanbaren Werkstoffen mit einer Zugfestigkeit bis 800 N/mm².

- Zum Schneiden von metrischen ISO-Gewinden DIN 13
- Form B = geschlossen, vorgeschlitzt

For general use in good machinable materials up to 800 N/mm² (22,5 HRC) tensile strength.

- For cutting metric ISO-Thread DIN 13
- Form B = preslotted, closed

Ø d1 mm	Bolzen / Bolt mm	Ø d2 mm	H mm		Artikel-Nr. Part-No.
M 1 x 0,25	0,97	16	5	1	4200 11 00100
M 1,1 x 0,25	1,07	16	5	1	4200 11 00110
M 1,2 x 0,25	1,17	16	5	1	4200 11 00120
M 1,4 x 0,3	1,36	16	5	1	4200 11 00140
M 1,6 x 0,35	1,54	16	5	1	4200 11 00160
M 1,7 x 0,35	1,64	16	5	1	4200 11 00170
M 1,8 x 0,35	1,74	16	5	1	4200 11 00180
M 2 x 0,4	1,93	16	5	1	4200 11 00200
M 2,2 x 0,45	2,13	16	5	1	4200 11 00220
M 2,3 x 0,4	2,23	16	5	1	4200 11 00230
M 2,5 x 0,45	2,43	16	5	1	4200 11 00250
M 2,6 x 0,45	2,53	16	5	1	4200 11 00260
M 3 x 0,5	2,92	20	5	1	4200 11 00300
M 3,5 x 0,6	3,41	20	5	1	4200 11 00350
M 4 x 0,7	3,91	20	5	1	4200 11 00400
M 5 x 0,8	4,90	20	7	1	4200 11 00500
M 6 x 1	5,88	20	7	1	4200 11 00600
M 7 x 1	6,88	25	9	1	4200 11 00700
M 8 x 1,25	7,87	25	9	1	4200 11 00800
M 9 x 1,25	8,87	25	9	1	4200 11 00900
M 10 x 1,5	9,85	30	11	1	4200 11 01000
M 12 x 1,75	11,83	38	14	1	4200 11 01200
M 14 x 2	13,82	38	14	1	4200 11 01400
M 16 x 2	15,82	45	18	1	4200 11 01600
M 18 x 2,5	17,79	45	18	1	4200 11 01800
M 20 x 2,5	19,79	45	18	1	4200 11 02000
M 22 x 2,5	21,79	55	22	1	4200 11 02200
M 24 x 3	23,77	55	22	1	4200 11 02400
M 27 x 3	26,77	65	25	1	4200 11 02700
M 30 x 3,5	29,73	65	25	1	4200 11 03000
M 33 x 3,5	32,73	65	25	1	4200 11 03300
M 36 x 4	35,70	65	25	1	4200 11 03600
M 39 x 4	38,70	75	30	1	4200 11 03900
M 42 x 4,5	41,69	75	30	1	4200 11 04200
M 45 x 4,5	44,69	90	36	1	4200 11 04500
M 48 x 5	47,66	90	36	1	4200 11 04800
M 52 x 5	51,66	90	36	1	4200 11 05200



M

SCHNEIDEISEN
DIES

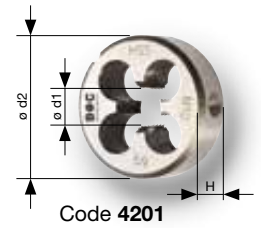

Für den allgemeinen Einsatz in gut zerspanbaren Werkstoffen mit einer Zugfestigkeit bis 800 N/mm².

- Zum Schneiden von metrischen ISO-Gewinden DIN 13
- Form B = geschlossen, vorgeschlitzt

For general use in good machinable materials up to 800 N/mm² (22,5 HRC) tensile strength.

- For cutting metric ISO-Thread DIN 13
- Form B = preslotted, closed

\varnothing d1 mm	Bolzen / Bolt mm	\varnothing d2 mm	H mm		Artikel-Nr. Part-No.
M 3 x 0,5	2,92	25	9	1	4201 11 00300
M 4 x 0,7	3,91	25	9	1	4201 11 00400
M 5 x 0,8	4,90	25	9	1	4201 11 00500
M 6 x 1	5,88	25	9	1	4201 11 00600
M 8 x 1,25	7,87	25	9	1	4201 11 00800
M 10 x 1,5	9,85	25	9	1	4201 11 01000
M 12 x 1,75	11,83	25	9	1	4201 11 01200

BC Metall-Mini Box / BC Metal-Mini-Box

Bezeichnung Description	Teile Pieces	Inhalt Content	Artikel-Nr. Part-No.
MSR 8	8 M3 – M12 (25 x 9)	Schneideisen / Circular dies (25 x 9) M 3 · M 4 · M 5 · M 6 · M 8 · M 10 · M 12 Halter / Holder DIN 225 25 x 9	4200 14 10007

BC Industrie-Kassette / BC Metal-Box

Bezeichnung Description	Teile Pieces	Inhalt Content	Artikel-Nr. Part-No.
GS 25	31 M3 – M12 (25 x 9)	HGB-Sätze 3-tlg. / Hand-tap sets 3 pcs. DIN 352 HSS + Schneideisen / Circular dies (25 x 9) HSS, M3 · M4 · M5 · M6 · M8 · M10 · M12 Halter / Holder DIN 225, 25 x 9 Windeisen / Tap wrench DIN 1814 Gr. 1,5 Schraubendreher / Screwdriver	6000 14 10025



MSR 8



GS 25



M

SCHNEIDEISEN
DIES

M Schneideisen DIN EN 22568 HSS-E (Co5) VAP

Circular dies DIN EN 22568 HSS-E (Co5) VAP

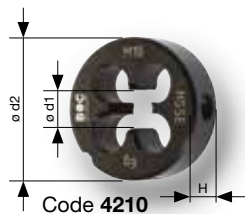

M	DIN EN 22568	HSS-E Co5	VAP	VA INOX	FORM B	Tol. 6g	60°	1000 N/mm ²
----------	------------------------	---------------------	------------	-------------------	------------------	-------------------	------------	----------------------------------

- Zum Schneiden von metrischen ISO-Gewinden DIN 13
- Für VA- und rostfreie Stähle
- Form B = geschlossen, vorgeschlitzt
- Schälanschnitt, dampfangelassen
- For cutting metric ISO-Thread DIN 13
- Stainless steel
- Form B = preslotted, closed
- Spiral point, steam tempered

Ø d1 mm	Bolzen / Bolt mm	Ø d2 mm	H mm		Artikel-Nr. Part-No.
M 3 x 0,5	2,92	20	5	1	4210 11 00300
M 4 x 0,7	3,91	20	5	1	4210 11 00400
M 5 x 0,8	4,90	20	7	1	4210 11 00500
M 6 x 1	5,88	20	7	1	4210 11 00600
M 8 x 1,25	7,87	25	9	1	4210 11 00800
M 10 x 1,5	9,85	30	11	1	4210 11 01000
M 12 x 1,75	11,83	38	14	1	4210 11 01200
M 14 x 2	13,82	38	14	1	4210 11 01400
M 16 x 2	15,82	45	18	1	4210 11 01600
M 18 x 2,5	17,79	45	18	1	4210 11 01800
M 20 x 2,5	19,79	45	18	1	4210 11 02000

M

SCHNEIDEISEN
DIES

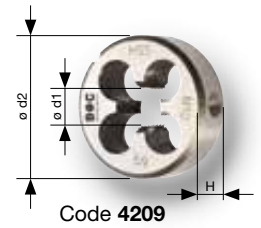

M	LINKS LEFT HAND LH	DIN EN 22568	HSS G	FORM B	Tol. 6g	 60°	800 N/mm ²
----------	---------------------------------	------------------------	-----------------	------------------	-------------------	----------------	---------------------------------

Für den allgemeinen Einsatz in gut zerspanbaren Werkstoffen mit einer Zugfestigkeit bis 800 N/mm².

- Zum Schneiden von metrischen ISO-Gewinden DIN 13
- Form B = geschlossen, vorgeschlitzt

For general use in good machinable materials up to 800 N/mm² (22,5 HRC) tensile strength.

- For cutting metric ISO-Thread DIN 13
- Form B = preslotted, closed

Ø d1 mm	Bolzen / Bolt mm	Ø d2 mm	H mm		Artikel-Nr. Part-No.
M 3 x 0,5	2,92	20	5	1	4209 11 00300
M 4 x 0,7	3,91	20	5	1	4209 11 00400
M 5 x 0,8	4,90	20	7	1	4209 11 00500
M 6 x 1	5,88	20	7	1	4209 11 00600
M 8 x 1,25	7,87	25	9	1	4209 11 00800
M 10 x 1,5	9,85	30	11	1	4209 11 01000
M 12 x 1,75	11,83	38	14	1	4209 11 01200
M 14 x 2	13,82	38	14	1	4209 11 01400
M 16 x 2	15,82	45	18	1	4209 11 01600
M 18 x 2,5	17,79	45	18	1	4209 11 01800
M 20 x 2,5	19,79	45	18	1	4209 11 02000
M 22 x 2,5	21,79	55	22	1	4209 11 02200
M 24 x 3	23,77	55	22	1	4209 11 02400



M

M Sechskant Schneidmuttern DIN 382 HSS-G
Hexagon die nuts DIN 382 HSS-G

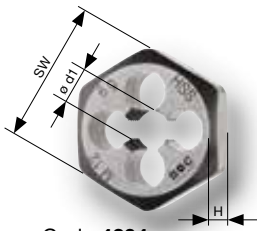

Code 4204

M
DIN 382
HSS G
Tol. 6g
 **60°**
800 N/mm²

Für den allgemeinen Einsatz in gut zerspanbaren Werkstoffen mit einer Zugfestigkeit bis 800 N/mm².

- Zum Schneiden von metrischen ISO-Gewinden DIN 13
- Ideal zur Verwendung an schwer zugänglichen Stellen

For general use in good machinable materials up to 800 N/mm² (22,5 HRC) tensile strength.

- For cutting metric ISO-Thread DIN 13
- Ideal for operations at difficult accessible places

Ø d1 mm	Bolzen / Bolt mm	SW mm	H mm		Artikel-Nr. Part-No.
M 3 x 0,5	2,92	19	5	1	4204 11 00300
M 4 x 0,7	3,91	19	5	1	4204 11 00400
M 5 x 0,8	4,90	19	7	1	4204 11 00500
M 6 x 1	5,88	19	7	1	4204 11 00600
M 8 x 1,25	7,87	22	9	1	4204 11 00800
M 10 x 1,5	9,85	27	11	1	4204 11 01000
M 12 x 1,75	11,83	36	14	1	4204 11 01200
M 14 x 2	13,82	36	14	1	4204 11 01400
M 16 x 2	15,82	41	18	1	4204 11 01600
M 18 x 2,5	17,79	41	18	1	4204 11 01800
M 20 x 2,5	19,79	41	18	1	4204 11 02000
M 22 x 2,5	21,79	50	22	1	4204 11 02200
M 24 x 3	23,76	50	22	1	4204 11 02400



M

SCHNEIDMUTTERN
HEXAGON DIE NUTS

Einschnittgewindebohrer DIN 352 HSS-G | M

Short machine taps DIN 352 HSS-G

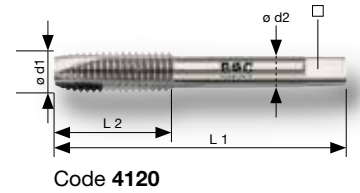

Code	P					M	K	N			
	1.1	2.1	3.1	4.1	5.1	1.1 - 4.1	2.1 - 2.2 / 4.1 - 4.2	1.1 - 1.3	1.4 - 1.6	2.1 - 2.5	4.2
4120	⊕	⊕				⊕	⊕	⊕			⊕

- Zum Schneiden von metrischen ISO-Gewinden DIN 13
- Für Hand- und Maschinengebrauch
- Form B = 4 – 5 Gang Anschnitt mit Schälanschnitt

- For cutting metric ISO-Thread DIN 13
- For manual and machine use
- Form B = 4 – 5 threads lead with spiral point (gun nose)

Ø d1 mm		L 1 mm	L 2 mm	Ø d2 mm			Artikel-Nr. Part-No.		Artikel-Nr. Part-No.
M 3 x 0,5	2,5	40	11	3,5	2,7	1	4120 03 00300	1	4120 07 00300
M 4 x 0,7	3,3	45	13	4,5	3,4	1	4120 03 00400	1	4120 07 00400
M 5 x 0,8	4,2	50	16	6,0	4,9	1	4120 03 00500	1	4120 07 00500
M 6 x 1	5,0	56	19	6,0	4,9	1	4120 03 00600	1	4120 07 00600
M 8 x 1,25	6,8	63	22	6,0	4,9	1	4120 03 00800	1	4120 07 00800
M 10 x 1,5	8,5	70	24	7,0	5,5	1	4120 03 01000	1	4120 07 01000
M 12 x 1,75	10,2	75	28	9,0	7,0	1	4120 03 01200	1	4120 07 01200

BC ABS-Box / BC ABS-Box

Bezeichnung Description	Teile Pieces	Inhalt Content	Artikel-Nr. Part-No.
EGB 15-K	15 M3 – M12	EGB / Short machine taps DIN 352 HSS-G M3 · M4 · M5 · M6 · M8 · M10 · M12 HSS-G Bohrer / HSS-drills DIN 338, Typ N Ø 2,5 · 3,3 · 4,2 · 5,0 · 6,8 · 8,5 · 10,2 mm Windeisen / Tap wrench DIN 1814 Gr. 1,5	4120 13 30015

BC Industrie-Kassette / BC Metal-Box

Bezeichnung Description	Teile Pieces	Inhalt Content	Artikel-Nr. Part-No.
EGB 15	15 M3 – M12	EGB / Short machine taps DIN 352 HSS-G M3 · M4 · M5 · M6 · M8 · M10 · M12 HSS-G Bohrer / HSS-drills DIN 338, Typ N Ø 2,5 · 3,3 · 4,2 · 5,0 · 6,8 · 8,5 · 10,2 mm Windeisen / Tap wrench DIN 1814 Gr. 1,5	4120 14 10015



EGB 15-K



EGB 15

M
EINSCHNITTGEWINDEBOHRER
SHORT MACHINE TAPS

M | Einschnittgewindebohrer DIN 352 HSS-E (Co5)

Short machine taps DIN 352 HSS-E (Co5)



Code 4125



Code	P					M	K	N			
	1.1	2.1	3.1	4.1	5.1	1.1 - 4.1	2.1 - 2.2 / 4.1 - 4.2	1.1 - 1.3	1.4 - 1.6	2.1 - 2.5	4.2
4125	☉	☉	☉				☉	☉	☉	☉	☉

- Zum Schneiden von metrischen ISO-Gewinden DIN 13
- Für Hand- und Maschinengebrauch
- Form B = 4 – 5 Gang Anschnitt mit Schälanschnitt

- For cutting metric ISO-Thread DIN 13
- For manual and machine use
- Form B = 4 – 5 threads lead with spiral point (gun nose)

Ø d1 mm		L 1 mm	L 2 mm	Ø d2 mm			Artikel-Nr. Part-No.
M 3 x 0,5	2,5	40	11	3,5	2,7	1	4125 03 00300
M 4 x 0,7	3,3	45	13	4,5	3,4	1	4125 03 00400
M 5 x 0,8	4,2	50	16	6,0	4,9	1	4125 03 00500
M 6 x 1	5,0	56	19	6,0	4,9	1	4125 03 00600
M 8 x 1,25	6,8	63	22	6,0	4,9	1	4125 03 00800
M 10 x 1,5	8,5	70	24	7,0	5,5	1	4125 03 01000
M 12 x 1,75	10,2	75	28	9,0	7,0	1	4125 03 01200

BC ABS-Box / BC ABS-Box

Bezeichnung Description	Teile Pieces	Inhalt Content	Artikel-Nr. Part-No.
EGB 15-K Co	15 M3 – M12	EGB / Short machine taps DIN 352 HSS-E (Co5) M3 · M4 · M5 · M6 · M8 · M10 · M12 HSS-G Bohrer / HSS-drills DIN 338, Typ N Ø 2,5 · 3,3 · 4,2 · 5,0 · 6,8 · 8,5 · 10,2 mm Windeisen / Tap wrench DIN 1814 Gr. 1,5	4125 13 30015



EGB 15-K Co



M

EINSCHNITTGEWINDEBOHRER
SHORT MACHINE TAPS

Einschnittgewindebohrer DIN 352 HSS-G | M

Short machine taps DIN 352 HSS-G

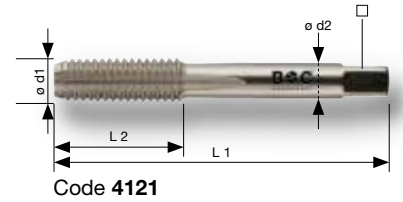

Code	P					M	K	N			
	1.1	2.1	3.1	4.1	5.1	1.1 - 4.1	2.1 - 2.2 / 4.1 - 4.2	1.1 - 1.3	1.4 - 1.6	2.1 - 2.5	4.2
4121	☉	☉				☉	☉	☉			☉

- Zum Schneiden von metrischen ISO-Gewinden DIN 13
- Für Hand- und Maschinengebrauch
- 2 – 3 Gang Anschnitt für Durchgangs- und Sackloch

- For cutting metric ISO-Thread DIN 13
- For manual and machine use
- 2 – 3 threads lead for through- and blind hole

Ø d1 mm		L 1 mm	L 2 mm	Ø d2 mm	□ mm		Artikel-Nr. Part-No.
M 1 x 0,25	0,75	32	5,5	2,5	2,1	1	4121 03 00100
M 1,1 x 0,25	0,85	32	5,5	2,5	2,1	1	4121 03 00110
M 1,2 x 0,25	0,95	32	5,5	2,5	2,1	1	4121 03 00120
M 1,4 x 0,3	1,10	32	7,0	2,5	2,1	1	4121 03 00140
M 1,6 x 0,35	1,25	32	8,0	2,5	2,1	1	4121 03 00160
M 1,7 x 0,35	1,30	32	8,0	2,5	2,1	1	4121 03 00170
M 1,8 x 0,35	1,45	32	8,0	2,5	2,1	1	4121 03 00180
M 2 x 0,4	1,60	36	8,0	2,8	2,1	1	4121 03 00200
M 2,2 x 0,45	1,75	36	9,0	2,8	2,1	1	4121 03 00220
M 2,3 x 0,4	1,90	36	9,0	2,8	2,1	1	4121 03 00230
M 2,5 x 0,45	2,05	40	9,0	2,8	2,1	1	4121 03 00250
M 2,6 x 0,45	2,10	40	9,0	2,8	2,1	1	4121 03 00260
M 3 x 0,5	2,50	40	11,0	3,5	2,7	1	4121 03 00300
M 3,5 x 0,6	2,90	45	13,0	4,0	3,0	1	4121 03 00350
M 4 x 0,7	3,30	45	13,0	4,5	3,4	1	4121 03 00400
M 5 x 0,8	4,20	50	16,0	6,0	4,9	1	4121 03 00500
M 6 x 1	5,00	50	19,0	6,0	4,9	1	4121 03 00600
M 7 x 1	6,00	50	19,0	6,0	4,9	1	4121 03 00700
M 8 x 1,25	6,80	56	22,0	6,0	4,9	1	4121 03 00800
M 9 x 1,25	7,80	63	22,0	7,0	5,5	1	4121 03 00900
M 10 x 1,5	8,50	70	24,0	7,0	5,5	1	4121 03 01000
M 12 x 1,75	10,20	75	29,0	9,0	7,0	1	4121 03 01200
M 14 x 2	12,00	80	30,0	11,0	9,0	1	4121 03 01400
M 16 x 2	14,00	80	32,0	12,0	9,0	1	4121 03 01600
M 18 x 2,5	15,50	95	40,0	14,0	11,0	1	4121 03 01800
M 20 x 2,5	17,50	95	40,0	16,0	12,0	1	4121 03 02000
M 22 x 2,5	19,50	100	40,0	18,0	14,5	1	4121 03 02200
M 24 x 3	21,00	110	50,0	18,0	14,5	1	4121 03 02400
M 27 x 3	24,00	110	50,0	20,0	16,0	1	4121 03 02700
M 30 x 3,5	26,50	125	56,0	22,0	18,0	1	4121 03 03000
M 33 x 3,5	29,50	125	56,0	25,0	20,0	1	4121 03 03300
M 36 x 4	32,00	150	63,0	28,0	22,0	1	4121 03 03600
M 39 x 4	35,00	150	63,0	32,0	24,0	1	4121 03 03900
M 42 x 4,5	37,50	150	63,0	32,0	24,0	1	4121 03 04200
M 45 x 4,5	40,50	160	70,0	36,0	29,0	1	4121 03 04500
M 48 x 5	43,00	180	75,0	36,0	29,0	1	4121 03 04800
M 52 x 5	47,00	180	75,0	40,0	32,0	1	4121 03 05200



M Einschnittgewindebohrer DIN 352 HSS-E (Co5) VAP

Short machine taps DIN 352 HSS-E (Co5) VAP

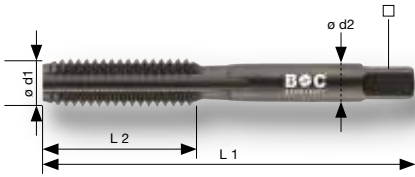

Code 4111



Code	P		M		K		N				
	1.1	2.1	3.1	4.1	5.1	1.1 - 2.1	2.1 - 2.2 / 4.1 - 4.2	1.1 - 1.3	1.4 - 1.6	2.1 - 2.5	4.2
4111											

- Zum Schneiden von metrischen ISO-Gewinden DIN 13
- VA- und rostfreie Stähle
- Für Hand- und Maschinengebrauch
- 2 – 3 Gang Anschnitt für Durchgangs- und Sackloch

- For cutting metric ISO-Thread DIN 13
- Stainless steel
- For manual and machine use
- 2 – 3 threads lead for through- and blind hole

Ø d1 mm		L 1 mm	L 2 mm	Ø d2 mm			Artikel-Nr. Part-No.
M 3 x 0,5	2,5	40	11	3,5	2,7	1	4111 03 00300
M 4 x 0,7	3,3	45	13	4,5	3,4	1	4111 03 00400
M 5 x 0,8	4,2	50	16	6,0	4,9	1	4111 03 00500
M 6 x 1	5,0	50	19	6,0	4,9	1	4111 03 00600
M 8 x 1,25	6,8	56	22	6,0	4,9	1	4111 03 00800
M 10 x 1,5	8,5	70	24	7,0	5,5	1	4111 03 01000
M 12 x 1,75	10,2	75	29	9,0	7,0	1	4111 03 01200
M 14 x 2	12,0	80	30	11,0	9,0	1	4111 03 01400
M 16 x 2	14,0	80	32	12,0	9,0	1	4111 03 01600
M 18 x 2,5	15,5	95	40	14,0	11,0	1	4111 03 01800
M 20 x 2,5	17,5	95	40	16,0	12,0	1	4111 03 02000

 EINSCHNITTGEWINDEBOHRER
SHORT MACHINE TAPS

Einschnittgewindebohrer **LINKS** DIN 352 HSS-G | **M**
 Short machine taps **LEFT HAND** DIN 352 HSS-G

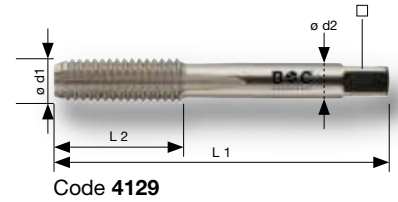

Code	P					M	K	N			
	1.1	2.1	3.1	4.1	5.1	1.1 - 4.1	2.1 - 2.2 / 4.1 - 4.2	1.1 - 1.3	1.4 - 1.6	2.1 - 2.5	4.2
4129	⊕	⊕				⊕	⊕	⊕			⊕

- Zum Schneiden von metrischen ISO-Gewinden DIN 13
- Für Hand- und Maschinengebrauch
- 2 – 3 Gang Anschnitt für Durchgangs- und Sackloch

- For cutting metric ISO-Thread DIN 13
- For manual and machine use
- 2 – 3 threads lead for through- and blind hole

Ø d1 mm		L 1 mm	L 2 mm	Ø d2 mm	□ mm		Artikel-Nr. Part-No.
M 3 x 0,5	2,5	40	11	3,5	2,7	1	4129 03 00300
M 4 x 0,7	3,3	45	13	4,5	3,4	1	4129 03 00400
M 5 x 0,8	4,2	50	16	6,0	4,9	1	4129 03 00500
M 6 x 1	5,0	50	19	6,0	4,9	1	4129 03 00600
M 8 x 1,25	6,8	56	22	6,0	4,9	1	4129 03 00800
M 10 x 1,5	8,5	70	24	7,0	5,5	1	4129 03 01000
M 12 x 1,75	10,2	75	29	9,0	7,0	1	4129 03 01200
M 14 x 2	12,0	80	30	11,0	9,0	1	4129 03 01400
M 16 x 2	14,0	80	32	12,0	9,0	1	4129 03 01600
M 18 x 2,5	15,5	95	40	14,0	11,0	1	4129 03 01800
M 20 x 2,5	17,5	95	40	16,0	12,0	1	4129 03 02000
M 22 x 2,5	19,5	100	40	18,0	14,5	1	4129 03 02200
M 24 x 3	21,0	110	50	18,0	14,5	1	4129 03 02400



S

EINSCHNITTGEWINDEBOHRER
SHORT MACHINE TAPS

M Maschinengewindebohrer DIN 371 / 376 HSS-G
Machine taps DIN 371 / 376 HSS-G



Code 4140 / DIN 371



Code 4150 / DIN 371

M	DIN 371/376	HSS	ISO2 6H	60°	B	3 x D	FORM C	35°	2,5 x D
Code	1.1	2.1	P 3.1	4.1	5.1	M 1.1 - 4.1	K 2.1 - 2.2 / 4.1 - 4.2	N 1.1 - 1.3 1.4 - 1.6 2.1 - 2.5 4.2	
4140 · 4141	☉	☉					☉	☉	☉
4150 · 4151	☉	☉					☉	☉	☉

- Zum Schneiden von metrischen ISO-Gewinden DIN 13.
- Form B = 4 – 5 Gang Anschnitt mit Schälanschnitt
- Form C 35° = 2 – 3 Gang Anschnitt mit Rechtsspirale 35°

- For cutting metric ISO-Thread DIN 13.
- Form B = 4 – 5 threads lead with spiral point (gun nose)
- Form C 35° = 2 – 3 threads lead with spiral flute 35°

Ø d1 mm	Icon	L 1 mm	L 2 mm		Ø d2 mm	mm	Icon	B	C 35°
			B	C 35°				Artikel-Nr. Part-No.	Artikel-Nr. Part-No.
DIN 371									
M 3 x 0,5	2,5	56	11	5	3,5	2,7	1	4140 03 00300	4150 03 00300
M 4 x 0,7	3,3	63	13	7	4,5	3,4	1	4140 03 00400	4150 03 00400
M 5 x 0,8	4,2	70	16	8	6,0	4,9	1	4140 03 00500	4150 03 00500
M 6 x 1	5,0	80	19	10	6,0	4,9	1	4140 03 00600	4150 03 00600
M 8 x 1,25	6,8	90	22	13	8,0	6,2	1	4140 03 00800	4150 03 00800
M 10 x 1,5	8,5	100	24	15	10,0	8,0	1	4140 03 01000	4150 03 01000
DIN 376									
M 12 x 1,75	10,2	110	29	18	9,0	7,0	1	4141 03 01200	4151 03 01200
M 14 x 2	12,0	110	30	20	11,0	9,0	1	4141 03 01400	4151 03 01400
M 16 x 2	14,0	110	32	22	12,0	9,0	1	4141 03 01600	4151 03 01600
M 18 x 2,5	15,5	125	34	25	14,0	11,0	1	4141 03 01800	4151 03 01800
M 20 x 2,5	17,5	140	34	25	16,0	12,0	1	4141 03 02000	4151 03 02000
M 22 x 2,5	19,5	140	34	27	18,0	14,5	1	4141 03 02200	4151 03 02200
M 24 x 3	21,0	160	38	30	18,0	14,5	1	4141 03 02400	4151 03 02400

SB-Verpackung / Display packaging

Ø d1 mm	Icon	L 1 mm	L 2 mm		Ø d2 mm	mm	Icon	B	C 35°
			B	C 35°				Artikel-Nr. Part-No.	Artikel-Nr. Part-No.
DIN 371									
M 3 x 0,5	2,5	56	11	5	3,5	2,7	1	4140 07 00300	4150 07 00300
M 4 x 0,7	3,3	63	13	7	4,5	3,4	1	4140 07 00400	4150 07 00400
M 5 x 0,8	4,2	70	16	8	6,0	4,9	1	4140 07 00500	4150 07 00500
M 6 x 1	5,0	80	19	10	6,0	4,9	1	4140 07 00600	4150 07 00600
M 8 x 1,25	6,8	90	22	13	8,0	6,2	1	4140 07 00800	4150 07 00800
M 10 x 1,5	8,5	100	24	15	10,0	8,0	1	4140 07 01000	4150 07 01000
DIN 376									
M 12 x 1,75	10,2	110	29	18	9,0	7,0	1	4141 07 01200	4151 07 01200
M 14 x 2	12,0	110	30	20	11,0	9,0	1	4141 07 01400	4151 07 01400
M 16 x 2	14,0	110	32	22	12,0	9,0	1	4141 07 01600	4151 07 01600



MASCHINENGEWINDEBOHRER
MACHINE TAPS



Code 4140 / DIN 371



Code 4150 / DIN 371

BC ABS-Boxen / BC ABS-Boxes

Bezeichnung Description	Teile Pieces	Inhalt Content	Artikel-Nr. Part-No.
MBA 7 G-K	7 M3 – M12	M3 · M4 · M5 · M6 · M8 · M10 · M12 geradegenutet / straight-flute, Form B	4140 13 30007
MBA 14 G-K	14 M3 – M12	M3 · M4 · M5 · M6 · M8 · M10 · M12 geradegenutet / straight-flute, Form B HSS-G Bohrer / HSS-drills DIN 338, Typ N Ø 2,5 · 3,3 · 4,2 · 5,0 · 6,8 · 8,5 · 10,2 mm	4140 13 30014
MBA 7 S-K	7 M3 – M12	M3 · M4 · M5 · M6 · M8 · M10 · M12 spiralgenutet / spiral-flute, Form C / 35° RSP / SFT	4150 13 30007
MBA 14 S-K	14 M3 – M12	M3 · M4 · M5 · M6 · M8 · M10 · M12 spiralgenutet / spiral-flute, Form C / 35° RSP / SFT HSS-G Bohrer / HSS-drills DIN 338, Typ N Ø 2,5 · 3,3 · 4,2 · 5,0 · 6,8 · 8,5 · 10,2 mm	4150 13 30014

BC Industrie-Kassetten / BC Metal-Boxes

Bezeichnung Description	Teile Pieces	Inhalt Content	Artikel-Nr. Part-No.
MBA 7-G	7 M3 – M12	M3 · M4 · M5 · M6 · M8 · M10 · M12 geradegenutet / straight-flute, Form B	4140 14 10007
MBA 14-G	14 M3 – M12	M3 · M4 · M5 · M6 · M8 · M10 · M12 geradegenutet / straight-flute, Form B HSS-G Bohrer / HSS-drills DIN 338, Typ N Ø 2,5 · 3,3 · 4,2 · 5,0 · 6,8 · 8,5 · 10,2 mm	4140 14 10014
MBA 7-S	7 M3 – M12	M3 · M4 · M5 · M6 · M8 · M10 · M12 spiralgenutet / spiral-flute, Form C / 35° RSP / SFT	4150 14 10007
MBA 14-S	14 M3 – M12	M3 · M4 · M5 · M6 · M8 · M10 · M12 spiralgenutet / spiral-flute, Form C / 35° RSP / SFT HSS-G Bohrer / HSS-drills DIN 338, Typ N Ø 2,5 · 3,3 · 4,2 · 5,0 · 6,8 · 8,5 · 10,2 mm	4150 14 10014



MBA 7 S-K



MBA 14 S-K



MBA 7-G



MBA 14-G



M

MASCHINENGEWINDEBOHRER
MACHINE TAPS

M Maschinengewindebohrer DIN 371 / 376 HSS-E (Co5)
Machine taps DIN 371 / 376 HSS-E (Co5)



Code 4142 / DIN 371



Code 4147 / DIN 371

M
DIN 371/376
HSS-E Co5
ISO2 6H
60°
B
3 x D
TiN

Code	P					M	K	N			
	1.1	2.1	3.1	4.1	5.1	1.1 - 4.1	2.1 - 2.2 / 4.1 - 4.2	1.1 - 1.3	1.4 - 1.6	2.1 - 2.5	4.2
4142 · 4143	☉	☉	☉				☉	☉	☉	☉	☉
4147 · 4148	☉	☉	☉				☉				☉

- Zum Schneiden von metrischen ISO-Gewinden DIN 13.
- Form B = 4 – 5 Gang Anschnitt mit Schälanschnitt

- For cutting metric ISO-Thread DIN 13.
- Form B = 4 – 5 threads lead with spiral point (gun nose)

Ø d1 mm	✎	L 1 mm	L 2 mm	Ø d2 mm	□ mm	📦	TiN	
							Artikel-Nr. Part-No.	Artikel-Nr. Part-No.
DIN 371								
M 2 x 0,4	1,60	45	8	2,8	2,1	1	4142 03 00200	-
M 2,5 x 0,45	2,05	50	9	2,8	2,1	1	4142 03 00250	-
M 3 x 0,5	2,50	56	11	3,5	2,7	1	4142 03 00300	4147 03 00300
M 4 x 0,7	3,30	63	13	4,5	3,4	1	4142 03 00400	4147 03 00400
M 5 x 0,8	4,20	70	16	6,0	4,9	1	4142 03 00500	4147 03 00500
M 6 x 1	5,00	80	19	6,0	4,9	1	4142 03 00600	4147 03 00600
M 7 x 1	6,00	80	19	7,0	5,5	1	4142 03 00700	-
M 8 x 1,25	6,80	90	22	8,0	6,2	1	4142 03 00800	4147 03 00800
M 10 x 1,50	8,50	100	24	10,0	8,0	1	4142 03 01000	4147 03 01000
DIN 376								
M 3 x 0,5	2,50	56	11	2,2	-	1	4143 03 00300	-
M 4 x 0,7	3,30	63	13	2,8	2,1	1	4143 03 00400	-
M 5 x 0,8	4,20	70	16	3,5	2,7	1	4143 03 00500	-
M 6 x 1	5,00	80	19	4,5	3,4	1	4143 03 00600	-
M 8 x 1,25	6,80	90	22	6,0	4,9	1	4143 03 00800	-
M 10 x 1,5	8,50	100	24	7,0	5,5	1	4143 03 01000	-
M 12 x 1,75	10,20	110	29	9,0	7,0	1	4143 03 01200	4148 03 01200
M 14 x 2	12,00	110	30	11,0	9,0	1	4143 03 01400	4148 03 01400
M 16 x 2	14,00	110	32	12,0	9,0	1	4143 03 01600	4148 03 01600
M 18 x 2,5	15,50	125	34	14,0	11,0	1	4143 03 01800	4148 03 01800
M 20 x 2,5	17,50	140	34	16,0	12,0	1	4143 03 02000	4148 03 02000
M 22 x 2,5	19,50	140	34	18,0	14,5	1	4143 03 02200	4148 03 02200
M 24 x 3	21,00	160	38	18,0	14,5	1	4143 03 02400	4148 03 02400
M 27 x 3	24,00	160	38	20,0	16,0	1	4143 03 02700	-
M 30 x 3,5	26,50	180	45	22,0	18,0	1	4143 03 03000	-
M 33 x 3,5	29,50	180	50	25,0	20,0	1	4143 03 03300	-
M 36 x 4	32,00	200	56	28,0	22,0	1	4143 03 03600	-

SB-Verpackung / Display packaging

Ø d1 mm	✎	L 1 mm	L 2 mm	Ø d2 mm	□ mm	📦	TiN	
							Artikel-Nr. Part-No.	Artikel-Nr. Part-No.
DIN 371								
M 3 x 0,5	2,5	56	11	3,5	2,7	1	4142 07 00300	-
M 4 x 0,7	3,3	63	13	4,5	3,4	1	4142 07 00400	-
M 5 x 0,8	4,2	70	16	6,0	4,9	1	4142 07 00500	-
M 6 x 1	5,0	80	19	6,0	4,9	1	4142 07 00600	-
M 8 x 1,25	6,8	90	22	8,0	6,2	1	4142 07 00800	-
M 10 x 1,5	8,5	100	24	10,0	8,0	1	4142 07 01000	-
DIN 376								
M 12 x 1,75	10,2	110	29	9,0	7,0	1	4143 07 01200	-
M 14 x 2	12,0	110	30	11,0	9,0	1	4143 07 01400	-
M 16 x 2	14,0	110	32	12,0	9,0	1	4143 07 01600	-



MASCHINENGEWINDEBOHRER
MACHINE TAPS

Maschinengewindebohrer DIN 371 / 376 HSS-E (Co5) | M

Machine taps DIN 371 / 376 HSS-E (Co5) | M



Code **4142** / DIN 371



Code **4147** / DIN 371

BC ABS-Boxen / BC ABS-Boxes

Bezeichnung Description	Teile Pieces	Inhalt Content	Artikel-Nr. Part-No.
MGB 7 G-K	7 M3 – M12	M3 · M4 · M5 · M6 · M8 · M10 · M12 geradegenutet / <i>straight-flute</i> , Form B	4142 13 30007
MGB 14 G-K	14 M3 – M12	M3 · M4 · M5 · M6 · M8 · M10 · M12 geradegenutet / <i>straight-flute</i> , Form B HSS-G Bohrer / <i>HSS-drills</i> DIN 338, Typ N Ø 2,5 · 3,3 · 4,2 · 5,0 · 6,8 · 8,5 · 10,2 mm	4142 13 30014
MGB 7 G-K TiN	7 M3 – M12	M3 · M4 · M5 · M6 · M8 · M10 · M12 geradegenutet / <i>straight-flute</i> , Form B	4147 13 30007
MGB 14 G-K TiN	14 M3 – M12	M3 · M4 · M5 · M6 · M8 · M10 · M12 geradegenutet / <i>straight-flute</i> , Form B HSS-G Bohrer / <i>HSS-drills</i> DIN 338, Typ N Ø 2,5 · 3,3 · 4,2 · 5,0 · 6,8 · 8,5 · 10,2 mm	4147 13 30014

BC Industrie-Kassetten / BC Metal-Boxes

Bezeichnung Description	Teile Pieces	Inhalt Content	Artikel-Nr. Part-No.
MGB 7-G	7 M3 – M12	M3 · M4 · M5 · M6 · M8 · M10 · M12 geradegenutet / <i>straight-flute</i> , Form B	4142 14 10007
MGB 14-G	14 M3 – M12	M3 · M4 · M5 · M6 · M8 · M10 · M12 geradegenutet / <i>straight-flute</i> , Form B HSS-G Bohrer / <i>HSS-drills</i> DIN 338, Typ N Ø 2,5 · 3,3 · 4,2 · 5,0 · 6,8 · 8,5 · 10,2 mm	4142 14 10014
MGB 21	21 M3 – M12	M3 · M4 · M5 · M6 · M8 · M10 · M12 geradegenutet + spiralgenutet / <i>straight-flute + spiral-flute</i> , Form B + C / 35° RSP / SFT , HSS-G Bohrer / <i>HSS-drills</i> DIN 338, Typ N Ø 2,5 · 3,3 · 4,2 · 5,0 · 6,8 · 8,5 · 10,2 mm	4142 14 10021

BC Runddose / BC Round-Box

Bezeichnung Description	Teile Pieces	Inhalt Content	Artikel-Nr. Part-No.
RG 12	12 M4 – M10	M4 · M5 · M6 · M8 · M10 geradegenutet / <i>straight-flute</i> , Form B HSS-G Bohrer / <i>HSS-drills</i> DIN 338, Typ N Ø 3,3 · 4,2 · 5,0 · 6,8 · 8,5 mm Kegelsenker / <i>Countersinks</i> 90° HSS 10,4 + 16,5 mm	4142 14 30012



MGB 7 G-K



MGB 14 G-K TiN



MGB 7-G



MGB 21



RG 12

M Maschinengewindebohrer DIN 371 / 376 HSS-E (Co5)
Machine taps DIN 371 / 376 HSS-E (Co5)



Code 4152 / DIN 371



Code 4157 / DIN 371

M
DIN 371/376
HSS-E Co5
FORM C
ISO2 6H
60°
35°
2,5 x D
TiN

Code	P					M	K	N			
	1.1	2.1	3.1	4.1	5.1	1.1 - 4.1	2.1 - 2.2 / 4.1 - 4.2	1.1 - 1.3	1.4 - 1.6	2.1 - 2.5	4.2
4152 · 4153	☉	☉	☉				☉	☉	☉		☉
4157 · 4158	☉	☉	☉				☉				☉

- Zum Schneiden von metrischen ISO-Gewinden DIN 13
- Form C 35° = 2 – 3 Gang Anschnitt mit Rechtsspirale 35°

- For cutting metric ISO-Thread DIN 13
- Form C 35° = 2 – 3 threads lead with spiral flute 35°

Ø d1 mm	☉	L 1 mm	L 2 mm	Ø d2 mm	□ mm	☉	TiN	
							Artikel-Nr. Part-No.	Artikel-Nr. Part-No.
DIN 371								
M 2 x 0,4	1,60	45	6	2,8	2,1	1	4152 03 00200	-
M 2,5 x 0,45	2,05	50	6	2,8	2,1	1	4152 03 00250	-
M 3 x 0,5	2,50	56	5	3,5	2,7	1	4152 03 00300	4157 03 00300
M 4 x 0,7	3,30	63	7	4,5	3,4	1	4152 03 00400	4157 03 00400
M 5 x 0,8	4,20	70	8	6,0	4,9	1	4152 03 00500	4157 03 00500
M 6 x 1	5,00	80	10	6,0	4,9	1	4152 03 00600	4157 03 00600
M 8 x 1,25	6,80	90	13	8,0	6,2	1	4152 03 00800	4157 03 00800
M 10 x 1,50	8,50	100	15	10,0	8,0	1	4152 03 01000	4157 03 01000
DIN 376								
M 3 x 0,5	2,50	56	5	2,2	-	1	4153 03 00300	-
M 4 x 0,7	3,30	63	7	2,8	2,1	1	4153 03 00400	-
M 5 x 0,8	4,20	70	8	3,5	2,7	1	4153 03 00500	-
M 6 x 1	5,00	80	10	4,5	3,4	1	4153 03 00600	-
M 8 x 1,25	6,80	90	13	6,0	4,9	1	4153 03 00800	-
M 10 x 1,5	8,50	100	15	7,0	5,5	1	4153 03 01000	-
M 12 x 1,75	10,20	110	18	9,0	7,0	1	4153 03 01200	4158 03 01200
M 14 x 2	12,00	110	20	11,0	9,0	1	4153 03 01400	4158 03 01400
M 16 x 2	14,00	110	22	12,0	9,0	1	4153 03 01600	4158 03 01600
M 18 x 2,5	15,50	125	25	14,0	11,0	1	4153 03 01800	4158 03 01800
M 20 x 2,5	17,50	140	25	16,0	12,0	1	4153 03 02000	4158 03 02000
M 22 x 2,5	19,50	140	27	18,0	14,5	1	4153 03 02200	4158 03 02200
M 24 x 3	21,00	160	30	18,0	14,5	1	4153 03 02400	4158 03 02400
M 27 x 3	24,00	160	30	20,0	16,0	1	4153 03 02700	-
M 30 x 3,5	26,50	180	35	22,0	18,0	1	4153 03 03000	-
M 33 x 3,5	29,50	180	35	25,0	20,0	1	4153 03 03300	-
M 36 x 4	32,00	200	40	28,0	22,0	1	4153 03 03600	-

SB-Verpackung / Display packaging

Ø d1 mm	☉	L 1 mm	L 2 mm	Ø d2 mm	□ mm	☉	TiN	
							Artikel-Nr. Part-No.	Artikel-Nr. Part-No.
DIN 371								
M 3 x 0,5	2,5	56	5	3,5	2,7	1	4152 07 00300	-
M 4 x 0,7	3,3	63	7	4,5	3,4	1	4152 07 00400	-
M 5 x 0,8	4,2	70	8	6,0	4,9	1	4152 07 00500	-
M 6 x 1	5,0	80	10	6,0	4,9	1	4152 07 00600	-
M 8 x 1,25	6,8	90	13	8,0	6,2	1	4152 07 00800	-
M 10 x 1,5	8,5	100	15	10,0	8,0	1	4152 07 01000	-
DIN 376								
M 12 x 1,75	10,2	110	18	9,0	7,0	1	4153 07 01200	-
M 14 x 2	12,0	110	20	11,0	9,0	1	4153 07 01400	-
M 16 x 2	14,0	110	22	12,0	9,0	1	4153 07 01600	-



MASCHINENGEWINDEBOHRER
MACHINE TAPS

Maschinengewindebohrer DIN 371 / 376 HSS-E (Co5) | M

Machine taps DIN 371 / 376 HSS-E (Co5) | M



BC ABS-Boxen / BC ABS-Boxes

Bezeichnung Description	Teile Pieces	Inhalt Content	Artikel-Nr. Part-No.
MGB 7 S-K	7 M3 – M12	M3 · M4 · M5 · M6 · M8 · M10 · M12 spiralgenutet / spiral-flute, Form C / 35° RSP / SFT	4152 13 30007
MGB 14 S-K	14 M3 – M12	M3 · M4 · M5 · M6 · M8 · M10 · M12 spiralgenutet / spiral-flute, Form C / 35° RSP / SFT HSS-G Bohrer / HSS-drills DIN 338, Typ N Ø 2,5 · 3,3 · 4,2 · 5,0 · 6,8 · 8,5 · 10,2 mm	4152 13 30014
MGB 7 S-K TiN	7 M3 – M12	M3 · M4 · M5 · M6 · M8 · M10 · M12 spiralgenutet / spiral-flute, Form C / 35° RSP / SFT	4157 13 30007
MGB 14 S-K TiN	14 M3 – M12	M3 · M4 · M5 · M6 · M8 · M10 · M12 spiralgenutet / spiral-flute, Form C / 35° RSP / SFT HSS-G Bohrer / HSS-drills DIN 338, Typ N Ø 2,5 · 3,3 · 4,2 · 5,0 · 6,8 · 8,5 · 10,2 mm	4157 13 30014

BC Industrie-Kassetten / BC Metal-Boxes

Bezeichnung Description	Teile Pieces	Inhalt Content	Artikel-Nr. Part-No.
MGB 7-S	7 M3 – M12	M3 · M4 · M5 · M6 · M8 · M10 · M12 spiralgenutet / spiral-flute, Form C / 35° RSP / SFT	4152 14 10007
MGB 14-S	14 M3 – M12	M3 · M4 · M5 · M6 · M8 · M10 · M12 spiralgenutet / spiral-flute, Form C / 35° RSP / SFT HSS-G Bohrer / HSS-drills DIN 338, Typ N Ø 2,5 · 3,3 · 4,2 · 5,0 · 6,8 · 8,5 · 10,2 mm	4152 14 10014
MGB 21	21 M3 – M12	M3 · M4 · M5 · M6 · M8 · M10 · M12 geradegenutet + spiralgenutet / straight-flute + spiral-flute, Form B + C / 35° RSP / SFT , HSS-G Bohrer / HSS-drills DIN 338, Typ N Ø 2,5 · 3,3 · 4,2 · 5,0 · 6,8 · 8,5 · 10,2 mm	4142 14 10021

BC Runddose / BC Round-Box

Bezeichnung Description	Teile Pieces	Inhalt Content	Artikel-Nr. Part-No.
RG 12 RSP	12 M4 – M10	M4 · M5 · M6 · M8 · M10 spiralgenutet / spiral-flute, Form C / 35° RSP / SFT HSS-G Bohrer / HSS-drills DIN 338, Typ N Ø 3,3 · 4,2 · 5,0 · 6,8 · 8,5 mm Kegelsenker / Countersinks 90° HSS 10,4 + 16,5 mm	4152 14 30012



M UNI Maschinengewindebohrer DIN 371 / 376 HSS-E (Co5)

UNI machine taps DIN 371 / 376 HSS-E (Co5)



Code 4163 / DIN 371



Code 4183 / DIN 371



Code 4181 / DIN 371



Code	P					M			N			
	1.1	2.1	3.1	4.1	5.1	1.1 - 4.1	1.1 - 1.2	2.1 - 2.2 / 4.1 - 4.2	1.1 - 1.3	1.4 - 1.6	2.1 - 2.5	4.2
4163 · 4164	⊕	⊕	⊕	⊕	⊕			⊕	⊕	⊕	⊕	⊕
4183 · 4184	⊕	⊕	⊕	⊕			⊕	⊕	⊕	⊕	⊕	⊕
4181 · 4182	⊕	⊕	⊕	⊕			⊕	⊕				⊕

Für den universellen Einsatz in allgemeinen Baustählen, Automatenstahl, unlegierten Einsatzstählen und Aluminiumlegierungen (kurzspanend).

- Zum Schneiden von metrischen ISO-Gewinden DIN 13
- Form B = 4 – 5 Gang Anschnitt mit Schälanschnitt

For universal use in general structural steel, free-cutting steel, unalloyed case hardening steel and aluminium-alloys (short chipping).

- For cutting metric ISO-Thread DIN 13
- Form B = 4 – 5 threads lead with spiral point (gun nose)

Ø d1 mm	L 1 mm	L 2 mm	Ø d2 mm	mm	Artikel-Nr. Part-No.	TiN		TiAlN	
						Artikel-Nr. Part-No.	Artikel-Nr. Part-No.		
DIN 371									
M 2 x 0,4	1,60	45	8	2,8	-	1	4163 03 00200	-	-
M 2,5 x 0,45	2,05	50	9	2,8	-	1	4163 03 00250	-	-
M 3 x 0,5	2,50	56	11	3,5	2,7	1	4163 03 00300	4183 03 00300	4181 03 00300
M 4 x 0,7	3,30	63	13	4,5	3,4	1	4163 03 00400	4183 03 00400	4181 03 00400
M 5 x 0,8	4,20	70	16	6,0	4,9	1	4163 03 00500	4183 03 00500	4181 03 00500
M 6 x 1	5,00	80	19	6,0	4,9	1	4163 03 00600	4183 03 00600	4181 03 00600
M 8 x 1,25	6,80	90	22	8,0	6,2	1	4163 03 00800	4183 03 00800	4181 03 00800
M 10 x 1,50	8,50	100	24	10,0	8,0	1	4163 03 01000	4183 03 01000	4181 03 01000
DIN 376									
M 12 x 1,75	10,20	110	29	9,0	7,0	1	4164 03 01200	4184 03 01200	4182 03 01200
M 14 x 2	12,00	110	30	11,0	9,0	1	4164 03 01400	4184 03 01400	4182 03 01400
M 16 x 2	14,00	110	32	12,0	9,0	1	4164 03 01600	4184 03 01600	4182 03 01600
M 18 x 2,5	15,50	125	34	14,0	11,0	1	4164 03 01800	4184 03 01800	4182 03 01800
M 20 x 2,5	17,50	140	34	16,0	12,0	1	4164 03 02000	4184 03 02000	4182 03 02000
M 22 x 2,5	19,50	140	34	18,0	14,5	1	4164 03 02200	4184 03 02200	4182 03 02200
M 24 x 3	21,00	160	38	18,0	14,5	1	4164 03 02400	4184 03 02400	4182 03 02400

BC ABS-Boxen / BC ABS-Boxes

Bezeichnung Description	Teile Pieces	Inhalt Content	Artikel-Nr. Part-No.
MGB 7 G-K GRÜNRING	7 M3 – M12	M3 · M4 · M5 · M6 · M8 · M10 · M12 geradegenutet / straight-flute, Form B	4163 13 30007
MGB 14 G-K GRÜNRING	14 M3 – M12	M3 · M4 · M5 · M6 · M8 · M10 · M12 geradegenutet / straight-flute, Form B DIN 338 HSS-G Ø 2,5 · 3,3 · 4,2 · 5,0 · 6,8 · 8,5 · 10,2 mm	4163 13 30014
MGB 7 G-K TiN P-PLUS	7 M3 – M12	M3 · M4 · M5 · M6 · M8 · M10 · M12 geradegenutet / straight-flute, Form B	4183 13 30007
MGB 14 G-K TiN P-PLUS	14 M3 – M12	M3 · M4 · M5 · M6 · M8 · M10 · M12 geradegenutet / straight-flute, Form B DIN 338 HSS-G Ø 2,5 · 3,3 · 4,2 · 5,0 · 6,8 · 8,5 · 10,2 mm	4183 13 30014
MGB 7 G-K TiAlN UNI	7 M3 – M12	M3 · M4 · M5 · M6 · M8 · M10 · M12 geradegenutet / straight-flute, Form B	4181 13 30007
BC Runddose / BC Round-Box			
RG 12 GRÜNRING	12 M4 – M10	M4 · M5 · M6 · M8 · M10 geradegenutet / straight-flute, Form B DIN 338 HSS-G, Ø 3,3 · 4,2 · 5,0 · 6,8 · 8,5 mm Kegelsenker / Countersinks 90° HSS-G 10,4 · 16,5 mm	4163 14 30012



UNI Maschinengewindebohrer DIN 371 / 376 HSS-E (Co5)
UNI machine taps DIN 371 / 376 HSS-E (Co5)

M

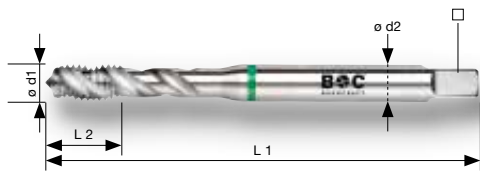

Code 4167 / DIN 371



Code 4187 / DIN 371



Code 4185 / DIN 371



Code	P					M			K			N			
	1.1	2.1	3.1	4.1	5.1	1.1 - 4.1	1.1 - 1.2	2.1 - 2.2 / 4.1 - 4.2	1.1 - 1.3	1.4 - 1.6	2.1 - 2.5	4.2			
4167 · 4168	⊗	⊗	⊗	⊗	⊗			⊗	⊗	⊗	⊗	⊗			
4187 · 4188	⊗	⊗	⊗	⊗	⊗		⊗	⊗				⊗			
4185 · 4186	⊗	⊗	⊗	⊗	⊗		⊗	⊗				⊗			

Für den universellen Einsatz in allgemeinen Baustählen, Automatenstahl, unlegierten Einsatzstählen und Aluminiumlegierungen (kurzspanend).

- Zum Schneiden von metrischen ISO-Gewinden DIN 13
- Form C 40° = 2 – 3 Gang Anschnitt mit Rechtsspirale 40°

For universal use in general structural steel, free-cutting steel, unalloyed case hardening steel and aluminium-alloys (short chipping).

- For cutting metric ISO-Thread DIN 13
- Form C 40° = 2 – 3 threads lead with spiral flute 40°

Ø d1 mm	Hand	L 1 mm	L 2 mm	Ø d2 mm	mm	mm	mm	TiN		TiALN
								Artikel-Nr. Part-No.	Artikel-Nr. Part-No.	Artikel-Nr. Part-No.
DIN 371										
M 3 x 0,5		2,50	56	5	3,5	2,7	1	4167 03 00300	4187 03 00300	4185 03 00300
M 4 x 0,7		3,30	63	7	4,5	3,4	1	4167 03 00400	4187 03 00400	4185 03 00400
M 5 x 0,8		4,20	70	8	6,0	4,9	1	4167 03 00500	4187 03 00500	4185 03 00500
M 6 x 1		5,00	80	10	6,0	4,9	1	4167 03 00600	4187 03 00600	4185 03 00600
M 8 x 1,25		6,80	90	13	8,0	6,2	1	4167 03 00800	4187 03 00800	4185 03 00800
M 10 x 1,50		8,50	100	15	10,0	8,0	1	4167 03 01000	4187 03 01000	4185 03 01000
DIN 376										
M 12 x 1,75		10,20	110	18	9,0	7,0	1	4168 03 01200	4188 03 01200	4186 03 01200
M 14 x 2		12,00	110	20	11,0	9,0	1	4168 03 01400	4188 03 01400	4186 03 01400
M 16 x 2		14,00	110	20	12,0	9,0	1	4168 03 01600	4188 03 01600	4186 03 01600
M 18 x 2,5		15,50	125	25	14,0	11,0	1	4168 03 01800	4188 03 01800	4186 03 01800
M 20 x 2,5		17,50	140	25	16,0	12,0	1	4168 03 02000	4188 03 02000	4186 03 02000
M 22 x 2,5		19,50	140	25	18,0	14,5	1	4168 03 02200	4188 03 02200	4186 03 02200
M 24 x 3		21,00	160	30	18,0	14,5	1	4168 03 02400	4188 03 02400	4186 03 02400

BC ABS-Boxen / BC ABS-Boxes

Bezeichnung Description	Teile Pieces	Inhalt Content	Artikel-Nr. Part-No.
MGB 7 S-K GRÜNRING	7 M3 – M12	M3 · M4 · M5 · M6 · M8 · M10 · M12 spiralgenutet / spiral-flute, Form C / 40° RSP / SFT	4167 13 30007
MGB 14 S-K GRÜNRING	14 M3 – M12	M3 · M4 · M5 · M6 · M8 · M10 · M12 spiralgenutet / spiral-flute, Form C / 40° RSP / SFT DIN 338 HSS-G Ø 2,5 · 3,3 · 4,2 · 5,0 · 6,8 · 8,5 · 10,2 mm	4167 13 30014
MGB 7 S-K TiN P-PLUS	7 M3 – M12	M3 · M4 · M5 · M6 · M8 · M10 · M12 spiralgenutet / spiral-flute, Form C / 40° RSP / SFT	4187 13 30007
MGB 14 S-K TiN P-PLUS	14 M3 – M12	M3 · M4 · M5 · M6 · M8 · M10 · M12 spiralgenutet / spiral-flute, Form C / 40° RSP / SFT DIN 338 HSS-G Ø 2,5 · 3,3 · 4,2 · 5,0 · 6,8 · 8,5 · 10,2 mm	4187 13 30014
MGB 7 S-K TiALN UNI	7 M3 – M12	M3 · M4 · M5 · M6 · M8 · M10 · M12 spiralgenutet / spiral-flute, Form C / 40° RSP / SFT	4185 13 30007



MASCHINENGEWINDEBOHRER
MACHINE TAPS

M PM Maschinengewindebohrer DIN 371 / 376 HSS-E HARDLUBE

PM machine taps DIN 371 / 376 HSS-E HARDLUBE

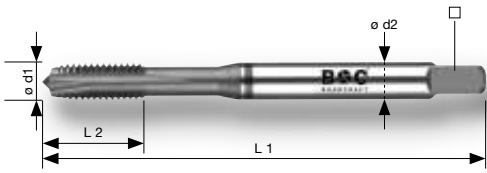

Code 4169 / DIN 371



Code 4179 / DIN 371



Code	P					M	K	N			
	1.1	2.1	3.1	4.1	5.1	1.1 - 2.1	2.1 - 2.2 / 4.1 - 4.2	1.1 - 1.3	1.4 - 1.6	2.1 - 2.5	4.2
4169 - 4180	⊕	⊕	⊕	⊕	⊕	⊕	⊕	⊕	⊕	⊕	⊕

Sehr hohe Verschleißfestigkeit und Zähigkeit durch HSS-E PM. Mit HARDLUBE-Beschichtung für minimierte Oberflächenreibung sowie gleichmäßig gute Spanbildung und reibungslosen Spanfluss.

- Zum Schneiden von metrischen ISO-Gewinden DIN 13
- Form B = 4 – 5 Gang Anschnitt mit Schälanschnitt
- Form C 40° = 2 – 3 Gang Anschnitt mit Rechtsspirale 40°

Made of HSS-E PM for very high wear-resistance and toughness. With HARDLUBE-Coating for low surface friction and consistent chip flow.

- For cutting metric ISO-Thread DIN 13
- Form B = 4 – 5 threads lead with spiral point (gun nose)
- Form C 40° = 2 – 3 threads lead with spiral flute 40°

Ø d1 mm	Image	L 1 mm	L 2 mm		Ø d2 mm	mm	Image	B	C 40°
			B	C 40°				Artikel-Nr. Part-No.	Artikel-Nr. Part-No.
DIN 371									
M 3 x 0,5	2,5	56	9	5	3,5	2,7	1	4169 03 00300	4179 03 00300
M 4 x 0,7	3,3	63	12	7	4,5	3,4	1	4169 03 00400	4179 03 00400
M 5 x 0,8	4,2	70	13	8	6,0	4,9	1	4169 03 00500	4179 03 00500
M 6 x 1	5,0	80	15	10	6,0	4,9	1	4169 03 00600	4179 03 00600
M 8 x 1,25	6,8	90	18	13	8,0	6,2	1	4169 03 00800	4179 03 00800
M 10 x 1,5	8,5	100	20	15	10,0	8,0	1	4169 03 01000	4179 03 01000
DIN 376									
M 12 x 1,75	10,2	110	23	18	9,0	7,0	1	4170 03 01200	4180 03 01200
M 14 x 2	12,0	110	25	20	11,0	9,0	1	4170 03 01400	4180 03 01400
M 16 x 2	14,0	110	25	20	12,0	9,0	1	4170 03 01600	4180 03 01600
M 18 x 2,5	15,5	125	30	25	14,0	11,0	1	4170 03 01800	4180 03 01800
M 20 x 2,5	17,5	140	30	25	16,0	12,0	1	4170 03 02000	4180 03 02000
M 22 x 2,5	19,5	140	30	25	18,0	14,5	1	4170 03 02200	4180 03 02200
M 24 x 3	21,0	160	36	30	18,0	14,5	1	4170 03 02400	4180 03 02400

BC ABS-Boxen / BC ABS-Boxes

Bezeichnung Description	Teile Pieces	Inhalt Content	Artikel-Nr. Part-No.
MGB 14 G-K PM	14 M3 – M12	M3 · M4 · M5 · M6 · M8 · M10 · M12 geradegenutet / straight-flute, Form B DIN 338 HSS-E (Co8) TiALN Ø 2,5 · 3,3 · 4,2 · 5,0 · 6,8 · 8,5 · 10,2 mm	4169 13 30014
MGB 14 S-K PM	14 M3 – M12	M3 · M4 · M5 · M6 · M8 · M10 · M12 spiralgewindet / spiral-flute, Form C / 40° RSP / SFT DIN 338 HSS-E (Co8) TiALN Ø 2,5 · 3,3 · 4,2 · 5,0 · 6,8 · 8,5 · 10,2 mm	4179 13 30014



M

MASCHINENGEWINDEBOHRER
MACHINE TAPS

INOX Maschinengewindebohrer DIN 371 / 376 HSS-E (Co5) VAP | M

INOX machine taps DIN 371 / 376 HSS-E (Co5) VAP | M



Code 4144 / DIN 371



Code 4154 / DIN 371



Code	1.1	2.1	P			M	K	N			
			3.1	4.1	5.1	1.1 - 2.1	2.1 - 2.2 / 4.1 - 4.2	1.1 - 1.3	1.4 - 1.6	2.1 - 2.5	4.2

Spezielle Schneidengeometrie und vaporisierte Oberfläche, besonders für die Bearbeitung von VA- und rostfreien Stählen geeignet.

Special cutting edge geometry and vap. surface, especially suitable for stainless steel like AISI 304 and 316.

- Zum Schneiden von metrischen ISO-Gewinden DIN 13
- Form B = 4 – 5 Gang Anschnitt mit Schälanschnitt
- Form C 40° = 2 – 3 Gang Anschnitt mit Rechtsspirale 40°

- For cutting metric ISO-Thread DIN 13
- Form B = 4 – 5 threads lead with spiral point (gun nose)
- Form C 40° = 2 – 3 threads lead with spiral flute 40°

Ø d1 mm	Hand	L1 mm	L2 mm		Ø d2 mm	mm	Flute	B		C 40°	
			B	C 40°				Artikel-Nr. Part-No.	Artikel-Nr. Part-No.		
DIN 371											
M 3 x 0,5	2,5	56	11	6	3,5	2,7	1	4144 03 00300	4154 03 00300		
M 4 x 0,7	3,3	63	13	7	4,5	3,4	1	4144 03 00400	4154 03 00400		
M 5 x 0,8	4,2	70	16	8	6,0	4,9	1	4144 03 00500	4154 03 00500		
M 6 x 1	5,0	80	19	10	6,0	4,9	1	4144 03 00600	4154 03 00600		
M 8 x 1,25	6,8	90	22	14	8,0	6,2	1	4144 03 00800	4154 03 00800		
M 10 x 1,5	8,5	100	24	16	10,0	8,0	1	4144 03 01000	4154 03 01000		
DIN 376											
M 12 x 1,75	10,2	110	29	18	9,0	7,0	1	4145 03 01200	4155 03 01200		
M 14 x 2	12,0	110	30	20	11,0	9,0	1	4145 03 01400	4155 03 01400		
M 16 x 2	14,0	110	32	22	12,0	9,0	1	4145 03 01600	4155 03 01600		
M 18 x 2,5	15,5	125	34	25	14,0	11,0	1	4145 03 01800	4155 03 01800		
M 20 x 2,5	17,5	140	34	25	16,0	12,0	1	4145 03 02000	4155 03 02000		
M 22 x 2,5	19,5	140	34	27	18,0	14,5	1	4145 03 02200	4155 03 02200		
M 24 x 3	21,0	160	38	30	18,0	14,5	1	4145 03 02400	4155 03 02400		

BC ABS-Boxen / BC ABS-Boxes

Bezeichnung Description	Teile Pieces	Inhalt Content	Artikel-Nr. Part-No.
MGB 7 G-K BLAURING	7 M3 – M12	M3 · M4 · M5 · M6 · M8 · M10 · M12 geradegenutet / straight-flute, Form B	4144 13 30007
MGB 14 G-K BLAURING	14 M3 – M12	M3 · M4 · M5 · M6 · M8 · M10 · M12 geradegenutet / straight-flute, Form B DIN 338 HSS-E Ø 2,5 · 3,3 · 4,2 · 5,0 · 6,8 · 8,5 · 10,2 mm	4144 13 30014
MGB 7 S-K BLAURING	7 M3 – M12	M 3 - M 12, spiralgenutet / spiral-flute, Form C / 40° RSP	4154 13 30007
MGB 14 S-K BLAURING	14 M3 – M12	M3 · M4 · M5 · M6 · M8 · M10 · M12 spiralgenutet / spiral-flute, Form C / 40° RSP / SFT DIN 338 HSS-E Ø 2,5 · 3,3 · 4,2 · 5,0 · 6,8 · 8,5 · 10,2 mm	4154 13 30014
BC Runddose / BC Round-Box			
RG 12 VA BLAURING	12 M4 – M10	M4 · M5 · M6 · M8 · M10 geradegenutet / straight-flute, Form B DIN 338 HSS-E (Co5) Ø 3,3 · 4,2 · 5,0 · 6,8 · 8,5 mm, Kegelsenker / Countersinks 90° HSS-E (Co5) 10,4 · 16,5 mm	4144 14 30012



M HD Maschinengewindebohrer DIN 371 / 376 HSS-E (Co5)

HD machine taps DIN 371 / 376 HSS-E (Co5)

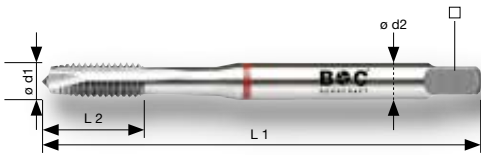

Code 4173 / DIN 371



Code 4189 / DIN 371



Code	P					M	K	N			
	1.1	2.1	3.1	4.1	5.1	1.1 - 4.1	2.1 - 2.2 / 4.1 - 4.2	1.1 - 1.3	1.4 - 1.6	2.1 - 2.5	4.2
4173 · 4174				☉	☉	☉					
4189 · 4190				☉	☉	☉					

Für den Einsatz in vergüteten und hitzebeständigen Stählen sowie Werkzeugstahl.

- Zum Schneiden von metrischen ISO-Gewinden DIN 13
- Form B = 4 – 5 Gang Anschnitt mit Schälanschnitt

For use in tempered and heat-resistant steels as well as tool steel.

- For cutting metric ISO-Thread DIN 13
- Form B = 4 – 5 threads lead with spiral point (gun nose)

Ø d1 mm	Form	L 1 mm	L 2 mm	Ø d2 mm	□ mm	Flutes	TiALN	
							Artikel-Nr. Part-No.	Artikel-Nr. Part-No.
DIN 371								
M 3 x 0,5	2,5	56	9	3,5	2,7	1	4173 03 00300	4189 03 00300
M 4 x 0,7	3,3	63	12	4,5	3,4	1	4173 03 00400	4189 03 00400
M 5 x 0,8	4,2	70	13	6,0	4,9	1	4173 03 00500	4189 03 00500
M 6 x 1	5,0	80	15	6,0	4,9	1	4173 03 00600	4189 03 00600
M 8 x 1,25	6,8	90	18	8,0	6,2	1	4173 03 00800	4189 03 00800
M 10 x 1,50	8,5	100	20	10,0	8,0	1	4173 03 01000	4189 03 01000
DIN 376								
M 12 x 1,75	10,2	110	23	9,0	7,0	1	4174 03 01200	4190 03 01200
M 14 x 2	12,0	110	25	11,0	9,0	1	4174 03 01400	4190 03 01400
M 16 x 2	14,0	110	25	12,0	9,0	1	4174 03 01600	4190 03 01600
M 18 x 2,5	15,5	125	30	14,0	11,0	1	4174 03 01800	4190 03 01800
M 20 x 2,5	17,5	140	30	16,0	12,0	1	4174 03 02000	4190 03 02000
M 22 x 2,5	19,5	140	30	18,0	14,5	1	4174 03 02200	4190 03 02200
M 24 x 3	21,0	160	36	18,0	14,5	1	4174 03 02400	4190 03 02400

BC ABS-Boxen / BC ABS-Boxes

Bezeichnung Description	Teile Pieces	Inhalt Content	Artikel-Nr. Part-No.
MGB 7 G-K ROTRING	7 M3 – M12	M3 · M4 · M5 · M6 · M8 · M10 · M12 geradegenutet / straight-flute, Form B	4173 13 30007
MGB 14 G-K ROTRING	14 M3 – M12	M3 · M4 · M5 · M6 · M8 · M10 · M12 geradegenutet / straight-flute, Form B DIN 338 HSS-E (Co5) Ø 2,5 · 3,3 · 4,2 · 5,0 · 6,8 · 8,5 · 10,2 mm	4173 13 30014
MGB 7 G-K HD	7 M3 – M12	M3 · M4 · M5 · M6 · M8 · M10 · M12 geradegenutet / straight-flute, Form B	4189 13 30007
MGB 14 G-K HD	14 M3 – M12	M3 · M4 · M5 · M6 · M8 · M10 · M12 geradegenutet / straight-flute, Form B DIN 338 HSS-E (Co8) Ø 2,5 · 3,3 · 4,2 · 5,0 · 6,8 · 8,5 · 10,2 mm	4189 13 30014

BC Runddose / BC Round-Box

RG 12 ROTRING	12 M4 – M10	M4 · M5 · M6 · M8 · M10 geradegenutet / straight-flute, Form B DIN 338 HSS-E (Co5) Ø 3,3 · 4,2 · 5,0 · 6,8 · 8,5 mm Kegelsenker / Countersinks 90° HSS-E (Co5) 10,4 · 16,5 mm	4173 14 30012
-------------------------	----------------	---	---------------



HD Maschinengewindebohrer DIN 371 / 376 HSS-E (Co5)
HD machine taps DIN 371 / 376 HSS-E (Co5)

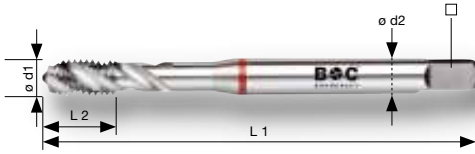

Code 4177 / DIN 371



Code 4191 / DIN 371



Code	P					M	K	N				
	1.1	2.1	3.1	4.1	5.1	1.1 - 2.1	1.1 - 1.2	4.1 - 4.2	1.1 - 1.3	1.4 - 1.6	2.1 - 2.5	4.2
4177 · 4178				⊕	⊕	⊕						
4191 · 4192				⊕	⊕	⊕						

Für den Einsatz in vergüteten und hitzebeständigen Stählen sowie Werkzeugstahl.

- Zum Schneiden von metrischen ISO-Gewinden DIN 13
- Form C 40° = 2 – 3 Gang Anschnitt mit Rechtsspirale 40°

For use in tempered and heat-resistant steels as well as tool steel.

- For cutting metric ISO-Thread DIN 13
- Form C 40° = 2 – 3 threads lead with spiral flute 40°

Ø d1 mm	Hand	L1 mm	L2 mm	Ø d2 mm	□ mm	Flute	TiALN	
							Artikel-Nr. Part-No.	Artikel-Nr. Part-No.
DIN 371								
M 3 x 0,5	2,5	56	5	3,5	2,7	1	4177 03 00300	4191 03 00300
M 4 x 0,7	3,3	63	7	4,5	3,4	1	4177 03 00400	4191 03 00400
M 5 x 0,8	4,2	70	8	6,0	4,9	1	4177 03 00500	4191 03 00500
M 6 x 1	5,0	80	10	6,0	4,9	1	4177 03 00600	4191 03 00600
M 8 x 1,25	6,8	90	13	8,0	6,2	1	4177 03 00800	4191 03 00800
M 10 x 1,50	8,5	100	15	10,0	8,0	1	4177 03 01000	4191 03 01000
DIN 376								
M 12 x 1,75	10,2	110	18	9,0	7,0	1	4178 03 01200	4192 03 01200
M 14 x 2	12,0	110	20	11,0	9,0	1	4178 03 01400	4192 03 01400
M 16 x 2	14,0	110	20	12,0	9,0	1	4178 03 01600	4192 03 01600
M 18 x 2,5	15,5	125	25	14,0	11,0	1	4178 03 01800	4192 03 01800
M 20 x 2,5	17,5	140	25	16,0	12,0	1	4178 03 02000	4192 03 02000
M 22 x 2,5	19,5	140	25	18,0	14,5	1	4178 03 02200	4192 03 02200
M 24 x 3	21,0	160	30	18,0	14,5	1	4178 03 02400	4192 03 02400

BC ABS-Boxen / BC ABS-Boxes

Bezeichnung Description	Teile Pieces	Inhalt Content	Artikel-Nr. Part-No.
MGB 7 S-K ROTRING	7 M3 – M12	M 3 - M 12, spiralgewinnet / spiral-flute, Form C / 40° RSP / SFT	4177 13 30007
MGB 14 S-K ROTRING	14 M3 – M12	M3 · M4 · M5 · M6 · M8 · M10 · M12 spiralgewinnet / spiral-flute, Form C / 40° RSP / SFT DIN 338 HSS-E (Co5) Ø 2,5 · 3,3 · 4,2 · 5,0 · 6,8 · 8,5 · 10,2 mm	4177 13 30014
MGB 7 S-K HD	7 M3 – M12	M3 · M4 · M5 · M6 · M8 · M10 · M12 spiralgewinnet / spiral-flute, Form C / 40° RSP / SFT	4191 13 30007
MGB 14 S-K HD	14 M3 – M12	M3 · M4 · M5 · M6 · M8 · M10 · M12 spiralgewinnet / spiral-flute, Form C / 40° RSP / SFT DIN 338 HSS-E (Co8) Ø 2,5 · 3,3 · 4,2 · 5,0 · 6,8 · 8,5 · 10,2 mm	4191 13 30014



M

MASCHINENGEWINDEBOHRER
MACHINE TAPS

M ALU Maschinengewindebohrer DIN 371 / 376 HSS-E (Co5)

ALU machine taps DIN 371 / 376 HSS-E (Co5)

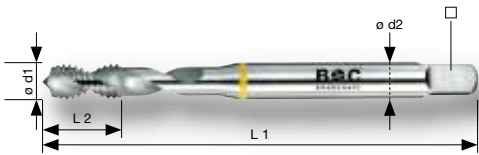

Code **4149** / DIN 371

Code **4149** / DIN 376



Code	P					M	K	N			
	1.1	2.1	3.1	4.1	5.1	1.1 - 4.1	2.1 - 2.2 / 4.1 - 4.2	1.1 - 1.3	1.4 - 1.6	2.1 - 2.5	4.2
4149											

Mit 2 breiten Spiralnuten und starkem Drall. Besonders geeignet für die Bearbeitung von Aluminium und Aluminiumlegierungen sowie weichen Kunststoffen (langspanend).

- Zum Schneiden von metrischen ISO-Gewinden DIN 13
- Form C 45° = 2 – 3 Gang Anschnitt mit Rechtsspirale 45°

With 2 wide spiral flutes 45°. Especially suitable for aluminium and aluminium-alloys as well as thermoplastics (long chipping).

- For cutting metric ISO-Thread DIN 13
- Form C 45° = 2 – 3 threads lead with spiral flute 45°

Ø d1 mm		L 1 mm	L 2 mm	Ø d2 mm			Artikel-Nr. Part-No.
DIN 371							
M 3 x 0,5	2,5	56	5	3,5	2,7	1	4149 03 00300
M 4 x 0,7	3,3	63	7	4,5	3,4	1	4149 03 00400
M 5 x 0,8	4,2	70	8	6,0	4,9	1	4149 03 00500
M 6 x 1	5,0	80	10	6,0	4,9	1	4149 03 00600
M 8 x 1,25	6,8	90	13	8,0	6,2	1	4149 03 00800
M 10 x 1,5	8,5	100	15	10,0	8,0	1	4149 03 01000
DIN 376							
M 12 x 1,75	10,2	110	18	9,0	7,0	1	4149 03 01200
M 14 x 2	12,0	110	20	11,0	9,0	1	4149 03 01400
M 16 x 2	14,0	110	20	12,0	9,0	1	4149 03 01600
M 18 x 2,5	15,5	125	25	14,0	11,0	1	4149 03 01800
M 20 x 2,5	17,5	140	25	16,0	12,0	1	4149 03 02000

BC ABS-Box / BC ABS-Box

Bezeichnung Description	Teile Pieces	Inhalt Content	Artikel-Nr. Part-No.
MGB 7 ALU-K	7 M3 – M12	M3 · M4 · M5 · M6 · M8 · M10 · M12 spiralgenutet / spiral-flute, Form C / 45° RSP / SFT	4149 13 30007



MGB 7 ALU-K

M

MASCHINENGEWINDEBOHRER
MACHINE TAPS

Maschinengewindebohrer (**ausgesetzte Zähne**) DIN 371 / 376 HSS-E (Co5) | **M**
Machine taps (**with interrupted threads**) DIN 371 / 376 HSS-E (Co5)

M

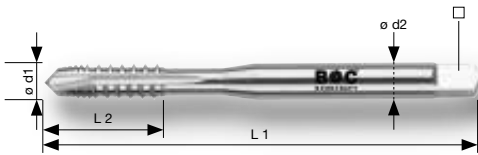

Code **4240** / DIN 371



Code **4241** / DIN 376



Code	P					M	K	N			
	1.1	2.1	3.1	4.1	5.1	1.1 - 4.1	2.1 - 2.2 / 4.1 - 4.2	1.1 - 1.3	1.4 - 1.6	2.1 - 2.5	4.2
4240	☉	☉				☉	☉	☉	☉	☉	☉

- Zum Schneiden von metrischen ISO-Gewinden DIN 13
- Form B = 4 – 5 Gang Anschnitt mit Schälanschnitt
- Mit ausgesetzten Zähnen

- For cutting metric ISO-Thread DIN 13
- Form B = 4 – 5 threads lead with spiral point (gun nose)
- With interrupted threads

Ø d1 mm		L 1 mm	L 2 mm	Ø d2 mm			Artikel-Nr. Part-No.
DIN 371							
M 3 x 0,5	2,5	56	11	3,5	2,7	1	4240 03 00300
M 4 x 0,7	3,3	63	13	4,5	3,4	1	4240 03 00400
M 5 x 0,8	4,2	70	16	6,0	4,9	1	4240 03 00500
M 6 x 1	5,0	80	19	6,0	4,9	1	4240 03 00600
M 8 x 1,25	6,8	90	22	8,0	6,2	1	4240 03 00800
M 10 x 1,5	8,5	100	24	10,0	8,0	1	4240 03 01000
DIN 376							
M 12 x 1,75	10,2	110	29	9,0	7,0	1	4241 03 01200



M

MASCHINENGEWINDEBOHRER
MACHINE TAPS

M GRAUGUSS Maschinengewindebohrer DIN 371 / 376 HSS-E (Co5) TiCN GREY CAST IRON machine taps DIN 371 / 376 HSS-E (Co5) TiCN

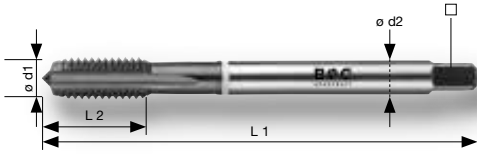

Code 4193 / DIN 371



Code 4193 / DIN 376



Code	P					M	K		N			
	1.1	2.1	3.1	4.1	5.1	1.1 - 4.1	1.1 - 1.2	2.1 - 2.2 / 4.1 - 4.2	1.1 - 1.3	1.4 - 1.6	2.1 - 2.5	4.2
4193												

Gewindebohrer speziell für die Bearbeitung von Grauguss (GG).

Machine tap especially suitable for grey cast iron (GG).

- Zum Schneiden von metrischen ISO-Gewinden DIN 13
- Form C = 2 - 3 Gang Anschnitt

- For cutting metric ISO-Thread DIN 13
- Form C = 2 - 3 threads lead

$\varnothing d1$ mm		L 1 mm	L 2 mm	$\varnothing d2$ mm			Artikel-Nr. Part-No.
DIN 371							
M 3 x 0,5	2,5	56	5	3,5	2,7	1	4193 03 00300
M 4 x 0,7	3,3	63	7	4,5	3,4	1	4193 03 00400
M 5 x 0,8	4,2	70	8	6,0	4,9	1	4193 03 00500
M 6 x 1	5,0	80	10	6,0	4,9	1	4193 03 00600
M 8 x 1,25	6,8	90	13	8,0	6,2	1	4193 03 00800
M 10 x 1,5	8,5	100	15	10,0	8,0	1	4193 03 01000
DIN 376							
M 12 x 1,75	10,2	110	18	9,0	7,0	1	4193 03 01200
M 14 x 2	12,0	110	20	11,0	9,0	1	4193 03 01400
M 16 x 2	14,0	110	20	12,0	9,0	1	4193 03 01600
M 18 x 2,5	15,5	125	25	14,0	11,0	1	4193 03 01800
M 20 x 2,5	17,5	140	25	16,0	12,0	1	4193 03 02000
M 22 x 2,5	19,5	140	30	18,0	14,5	1	4193 03 02200
M 24 x 3	21,0	160	36	18,0	14,5	1	4193 03 02400



M

 MASCHINENGWENDEBOHRER
MACHINE TAPS

Maschinengewindebohrer **extra lang** DIN 371 / 376 HSS-E (Co5) | **M**
 Machine taps **extra long** DIN 371 / 376 HSS-E (Co5)



Code **4161** / DIN 371



Code **4162** / DIN 371

M	DIN 371/376	HSS-E Co5	EXTRA LANGE EXTRA LONG Version	B	3 x D	FORM C	35°	2,5 x D
ISO2 6H	60°							

Code	P					M	K	N			
	1.1	2.1	3.1	4.1	5.1	1.1 - 4.1	2.1 - 2.2 / 4.1 - 4.2	1.1 - 1.3	1.4 - 1.6	2.1 - 2.5	4.2
4161 · 4162	⊕	⊕	⊕				⊕	⊕	⊕	⊕	⊕

- Zum Schneiden von metrischen ISO-Gewinden DIN 13.
 - Form B = 4 – 5 Gang Anschnitt mit Schälanschnitt
 - Form C 35° = 2 – 3 Gang Anschnitt mit Rechtsspirale 35°
- For cutting metric ISO-Thread DIN 13.
 - Form B = 4 – 5 threads lead with spiral point (gun nose)
 - Form C 35° = 2 – 3 threads lead with spiral flute 35°

Ø d1 mm	Image	L 1 mm	L 2 mm		Ø d2 mm	Image	Image	B		C 35°	
			B	C 35°				Artikel-Nr. Part-No.	Artikel-Nr. Part-No.		
DIN 371											
M 3 x 0,5	2,5	100	11	5	3,5	2,7	1	4161 03 00300	4162 03 00300		
M 4 x 0,7	3,3	100	13	7	4,5	3,4	1	4161 03 00400	4162 03 00400		
M 5 x 0,8	4,2	120	16	8	6,0	4,9	1	4161 03 00500	4162 03 00500		
M 6 x 1	5,0	120	19	10	6,0	4,9	1	4161 03 00600	4162 03 00600		
M 8 x 1,25	6,8	150	22	13	8,0	6,2	1	4161 03 00800	4162 03 00800		
M 10 x 1,5	8,5	150	24	15	10,0	8,0	1	4161 03 01000	4162 03 01000		
DIN 376											
M 12 x 1,75	10,2	150	29	18	9,0	7,0	1	4161 03 01200	4162 03 01200		



MF

MASCHINENGEWINDEBOHRER
MACHINE TAPS

M Maschinengewindebohrer LINKS DIN 371 / 376 HSS-E (Co5)

Machine taps LEFT HAND DIN 371 / 376 HSS-E (Co5)



Code 4159 / DIN 371



Code 4159 / DIN 376



Code	P					M	K	N			
	1.1	2.1	3.1	4.1	5.1	1.1 - 4.1	2.1 - 2.2 / 4.1 - 4.2	1.1 - 1.3	1.4 - 1.6	2.1 - 2.5	4.2
4159	⊕	⊕	⊕				⊕	⊕	⊕	⊕	⊕

- Zum Schneiden von metrischen ISO-Gewinden DIN 13
- Form C = 2 – 3 Gang Anschnitt

- For cutting metric ISO-Thread DIN 13
- Form C = 2 – 3 threads lead

Ø d1 mm		L 1 mm	L 2 mm	Ø d2 mm			Artikel-Nr. Part-No.
DIN 371							
M 3 x 0,5	2,5	56	11	3,5	2,7	1	4159 03 00300
M 4 x 0,7	3,3	63	13	4,5	3,4	1	4159 03 00400
M 5 x 0,8	4,2	70	16	6,0	4,9	1	4159 03 00500
M 6 x 1	5,0	80	19	6,0	4,9	1	4159 03 00600
M 8 x 1,25	6,8	90	22	8,0	6,2	1	4159 03 00800
M 10 x 1,5	8,5	100	24	10,0	8,0	1	4159 03 01000
DIN 376							
M 12 x 1,75	10,2	110	29	9,0	7,0	1	4159 03 01200
M 14 x 2	12,0	110	30	11,0	9,0	1	4159 03 01400
M 16 x 2	14,0	110	32	12,0	9,0	1	4159 03 01600
M 18 x 2,5	15,5	125	34	14,0	11,0	1	4159 03 01800
M 20 x 2,5	17,5	140	34	16,0	12,0	1	4159 03 02000
M 22 x 2,5	19,5	140	34	18,0	14,5	1	4159 03 02200
M 24 x 3	21,0	160	38	18,0	14,5	1	4159 03 02400



M

MASCHINENGEWINDEBOHRER
MACHINE TAPS

Kombi-Maschinengewindebohrer HSS-E (Co5) | M

Combined machine taps HSS-E (Co5) | M

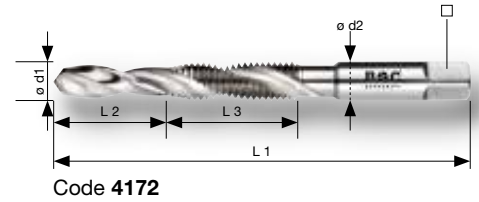

Code	P					M	K	N			
	1.1	2.1	3.1	4.1	5.1	1.1 - 4.1	2.1 - 2.2 / 4.1 - 4.2	1.1 - 1.3	1.4 - 1.6	2.1 - 2.5	4.2
4172	☉	☉				☉	☉	☉			

- Zum Schneiden von metrischen ISO-Gewinden DIN 13.
- Kernlochbohren und Gewindeschneiden in nur einem Arbeitsgang.

- For cutting metric ISO-Thread DIN 13.
- Drilling and threading in just one working-operation.

Ø d1 mm		L 1 mm	L 2 mm	L 3 mm	Ø d2 mm	□ mm		Artikel-Nr. Part-No.
M 3 x 0,5	2,5	56	16	11	3,0	2,4	1	4172 03 00300
M 4 x 0,7	3,3	63	18	14	4,0	3,0	1	4172 03 00400
M 5 x 0,8	4,2	71	20	18	5,0	3,8	1	4172 03 00500
M 6 x 1	5,0	80	22	22	6,0	4,9	1	4172 03 00600
M 8 x 1,25	6,8	95	26	25	8,0	6,2	1	4172 03 00800
M 10 x 1,5	8,5	106	30	31	10,0	8,0	1	4172 03 01000
M 12 x 1,75	10,2	115	32	35	12,0	9,0	1	4172 03 01200



M

MASCHINENGEWINDEBOHRER
MACHINE TAPS

M Kombi-Gewindebohrer-Bits 1/4" Schaft, HSS-G
 Combined thread-bits 1/4" hex-shank, HSS-G

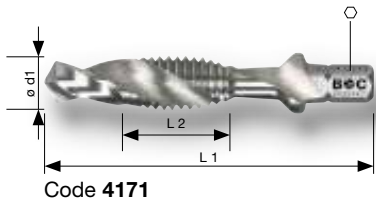

Code 4171

M
HSS G
ISO2 6H
60°
SPLIT POINT
1/4"
600 N/mm²
1 x D

Zum Kernlochbohren, Gewindeschneiden und Entgraten in nur einem Arbeitsgang. Hierzu eignen sich alle Hand-, Akku- und stationäre Bohrmaschinen mit Rechts- und Linkslauf. **Die Materialstärke darf den Gewindedurchmesser nicht übersteigen.**

For drilling, thread cutting and deburring in just one working-operation. For use in cordless and stationary drilling machines with right-hand and left-hand rotation. **Material thickness must not exceed diameter of thread.**

Ø d1 mm		L 1 mm	L 2 mm			Artikel-Nr. Part-No.
M 3 x 0,5	2,5	36	6	1/4" / 6,35 mm	1	4171 03 00300
M 4 x 0,7	3,3	39	8	1/4" / 6,35 mm	1	4171 03 00400
M 5 x 0,8	4,2	41	9	1/4" / 6,35 mm	1	4171 03 00500
M 6 x 1	5,0	44	11	1/4" / 6,35 mm	1	4171 03 00600
M 8 x 1,25	6,8	50	14	1/4" / 6,35 mm	1	4171 03 00800
M 10 x 1,5	8,5	59	15	1/4" / 6,35 mm	1	4171 03 01000

BC Metall-Mini Box / BC Metal-Mini-Box

Bezeichnung Description	Teile Pieces	Inhalt Content	Artikel-Nr. Part-No.
MB 7	7 M3 – M10	Kombi-Gewindebohrer / Combined thread-bits M3 · M4 · M5 · M6 · M8 · M10 Magnethalter / Magnet-holder	4171 14 10007



Abmessungen / Diameter	M 3	M 4	M 5	M 6	M 8	M 10
Kernloch-Ø / Core hole dia.	2,5 mm	3,3 mm	4,2 mm	5,0 mm	6,8 mm	8,5 mm
Drehzahl Stahl / RPM steel	1600	1200	950	800	600	450
Drehzahl Plastik / RPM plastic	1850	1450	1250	1000	750	550

Alles in einem Arbeitsgang / All in one operation:

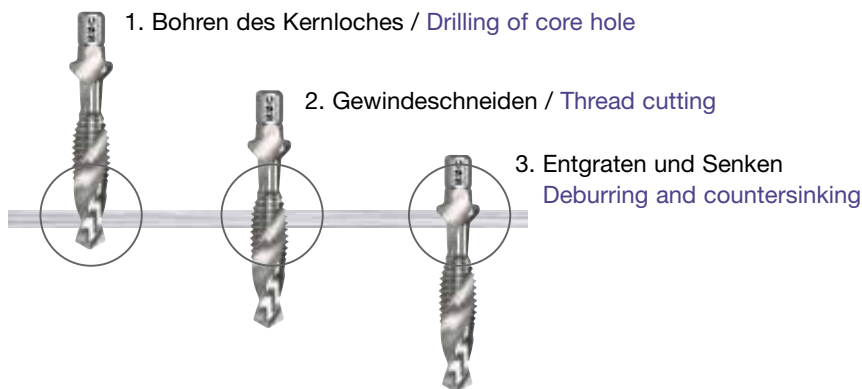

Maschinen-Muttergewindebohrer DIN 357 HSS-G | Machine nut taps DIN 357 HSS-G | M

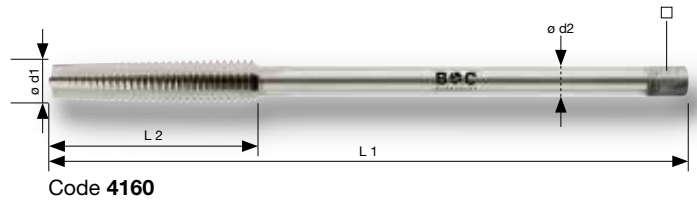

Code	P					M	K	N			
	1.1	2.1	3.1	4.1	5.1	1.1 - 4.1	2.1 - 2.2 / 4.1 - 4.2	1.1 - 1.3	1.4 - 1.6	2.1 - 2.5	4.2
4160	⊕	⊕				⊕	⊕	⊕			⊕

Zum Schneiden von metrischen ISO-Gewinden DIN 13

For cutting metric ISO-Thread DIN 13

Ø d1 mm		L 1 mm	L 2 mm	Ø d2 mm			Artikel-Nr. Part-No.
M 3 x 0,5	2,5	70	22	2,2	-	1	4160 03 00305
M 4 x 0,7	3,3	90	25	2,8	2,1	1	4160 03 00407
M 5 x 0,8	4,2	100	28	3,5	2,7	1	4160 03 00508
M 6 x 1	5,0	110	32	4,5	3,4	1	4160 03 00610
M 8 x 1,25	6,8	125	40	6,0	4,9	1	4160 03 00812
M 10 x 1,5	8,5	140	45	7,0	5,5	1	4160 03 01015
M 12 x 1,75	10,2	180	50	9,0	7,0	1	4160 03 01217
M 14 x 2	12,0	200	56	11,0	9,0	1	4160 03 01420
M 16 x 2	14,0	200	63	12,0	9,0	1	4160 03 01620



M
MUTTERGEWINDEBOHRER
NUT TAPS

M Gewindeformer DIN 371 / 376 HSS-E (Co5) TiN

Forming/Fluteless taps DIN 371 / 376 HSS-E (Co5) TiN

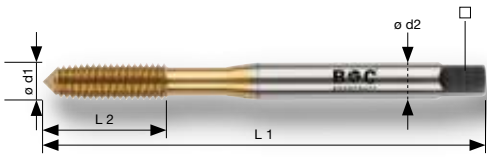

Code **4243** / DIN 371



Code **4243** / DIN 376



Code	P					M	K	N			
	1.1	2.1	3.1	4.1	5.1	1.1 - 2.1	1.1 - 4.2	1.1	1.4 - 1.5	2.1	4.2
4243	☉	☉	☉			☉			☉	☉	☉

- Zur spanlosen Herstellung metrischer ISO-Gewinden DIN 13
- Ohne Schmiernuten

- For chipless production of metric ISO-Threads DIN 13
- Without oil grooves

Ø d1 mm		L 1 mm	L 2 mm	Ø d2 mm			Artikel-Nr. Part-No.
DIN 371							
M 3 x 0,5	2,80	56	11	3,5	2,7	1	4243 03 00300
M 4 x 0,7	3,70	63	13	4,5	3,4	1	4243 03 00400
M 5 x 0,8	4,65	70	16	6,0	4,9	1	4243 03 00500
M 6 x 1	5,55	80	19	6,0	4,9	1	4243 03 00600
M 8 x 1,25	7,40	90	22	8,0	6,2	1	4243 03 00800
M 10 x 1,5	9,30	100	24	10,0	8,0	1	4243 03 01000
DIN 376							
M 12 x 1,75	11,20	110	29	9,0	7,0	1	4243 03 01200

Gewindeformer mit Schmiernuten DIN 371 / 376 HSS-E (Co5) TiN | M

Forming/Fluteless taps with oil grooves DIN 371 / 376 HSS-E (Co5) TiN

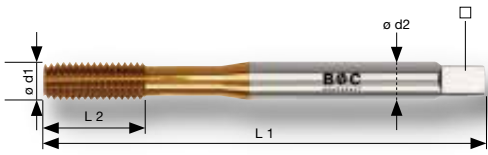

Code **4245** / DIN 371



Code **4245** / DIN 376



Code	P					M	K	N			
	1.1	2.1	3.1	4.1	5.1	1.1 - 2.1	1.1 - 4.2	1.1	1.4 - 1.5	2.1	4.2
4245	⊕	⊕	⊕			⊕		⊕	⊕	⊕	

- Zur spanlosen Herstellung metrischer ISO-Gewinden DIN 13
- Mit Schmiernuten

- For chipless production of metric ISO-Threads DIN 13
- With oil grooves

Ø d1 mm		L 1 mm	L 2 mm	Ø d2 mm			Artikel-Nr. Part-No.
DIN 371							
M 3 x 0,5	2,80	56	11	3,5	2,7	1	4245 03 00300
M 4 x 0,7	3,70	63	13	4,5	3,4	1	4245 03 00400
M 5 x 0,8	4,65	70	16	6,0	4,9	1	4245 03 00500
M 6 x 1,0	5,55	80	19	6,0	4,9	1	4245 03 00600
M 8 x 1,25	7,40	90	22	8,0	6,2	1	4245 03 00800
M 10 x 1,5	9,30	100	24	10,0	8,0	1	4245 03 01000
DIN 376							
M 12 x 1,75	11,20	110	29	9,0	7,0	1	4245 03 01200
M 14 x 2,0	13,10	110	30	11,0	9,0	1	4245 03 01400
M 16 x 2,0	15,10	110	32	12,0	9,0	1	4245 03 01600



M

GEWINDEFORMER
FORMING TAPS

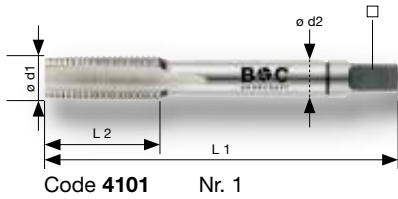

Code **4101** Nr. 1

Nr. 2



- Zum Schneiden von metrischen ISO-Feingewinden DIN 13
- Für Durchgangs- und Sackloch
- Nr. 1 Vorschneider 5 – 6 Gang Anschnitt
- Nr. 2 Fertigschneider 2 – 3 Gang Anschnitt
- For cutting metric fine ISO-Thread DIN 13
- For through- and blind hole
- No. 1 Rougher 5 – 6 threads lead
- No. 2 Finisher 2 – 3 threads lead

Ø d1 mm		L 1 mm	L 2 mm	Ø d2 mm			Satz / Set	Nr. 1	Nr. 2
MF 3 x 0,35	3,15	40	9	3,5	2,7	1	4101 11 00303	4101 11 10303	4101 11 20303
MF 4 x 0,35	3,65	45	10	4,5	3,4	1	4101 11 00403	4101 11 10403	4101 11 20403
MF 4 x 0,5	3,50	45	10	4,5	3,4	1	4101 11 00405	4101 11 10405	4101 11 20405
MF 5 x 0,5	4,50	50	12	6,0	4,9	1	4101 11 00505	4101 11 10505	4101 11 20505
MF 5 x 0,75	4,25	50	12	6,0	4,9	1	4101 11 00507	4101 11 10507	4101 11 20507
MF 6 x 0,5	5,50	50	14	6,0	4,9	1	4101 11 00605	4101 11 10605	4101 11 20605
MF 6 x 0,75	5,20	50	14	6,0	4,9	1	4101 11 00607	4101 11 10607	4101 11 20607
MF 7 x 0,75	6,20	50	14	6,0	4,9	1	4101 11 00707	4101 11 10707	4101 11 20707
MF 8 x 0,5	8,50	50	19	6,0	4,9	1	4101 11 00805	4101 11 10805	4101 11 20805
MF 8 x 0,75	7,20	50	19	6,0	4,9	1	4101 11 00807	4101 11 10807	4101 11 20807
MF 8 x 1	7,00	56	22	6,0	4,9	1	4101 11 00810	4101 11 10810	4101 11 20810
MF 9 x 0,75	8,20	56	19	7,0	5,5	1	4101 11 00907	4101 11 10907	4101 11 20907
MF 9 x 1	8,00	63	20	7,0	5,5	1	4101 11 00910	4101 11 10910	4101 11 20910
MF 10 x 0,35	9,20	63	20	7,0	5,5	1	4101 11 01007	4101 11 11007	4101 11 21007
MF 10 x 1	9,00	63	20	7,0	5,5	1	4101 11 01010	4101 11 11010	4101 11 21010
MF 10 x 1,25	8,80	70	24	7,0	5,5	1	4101 11 01012	4101 11 11012	4101 11 21012
MF 11 x 1	10,00	63	20	8,0	6,2	1	4101 11 01110	4101 11 11110	4101 11 21110
MF 11 x 1,25	9,80	63	22	8,0	6,2	1	4101 11 01112	4101 11 11112	4101 11 21112
MF 12 x 0,75	11,20	70	22	9,0	7,0	1	4101 11 01207	4101 11 11207	4101 11 21207
MF 12 x 1	11,00	70	22	9,0	7,0	1	4101 11 01210	4101 11 11210	4101 11 21210
MF 12 x 1,25	10,80	70	22	9,0	7,0	1	4101 11 01212	4101 11 11212	4101 11 21212
MF 12 x 1,5	10,50	70	22	9,0	7,0	1	4101 11 01215	4101 11 11215	4101 11 21215
MF 13 x 1	12,00	70	22	11,0	9,0	1	4101 11 01310	4101 11 11310	4101 11 21310
MF 13 x 1,5	11,50	70	22	11,0	9,0	1	4101 11 01315	4101 11 11315	4101 11 21315
MF 14 x 0,75	13,25	70	22	11,0	9,0	1	4101 11 01407	4101 11 11407	4101 11 21407
MF 14 x 1	13,00	70	22	11,0	9,0	1	4101 11 01410	4101 11 11410	4101 11 21410
MF 14 x 1,25	12,80	70	22	11,0	9,0	1	4101 11 01412	4101 11 11412	4101 11 21412
MF 14 x 1,5	12,50	70	22	11,0	9,0	1	4101 11 01415	4101 11 11415	4101 11 21415
MF 15 x 1	14,00	70	22	12,0	9,0	1	4101 11 01510	4101 11 11510	4101 11 21510
MF 15 x 1,5	13,50	70	22	12,0	9,0	1	4101 11 01515	4101 11 11515	4101 11 21515
MF 16 x 1	15,00	70	22	12,0	9,0	1	4101 11 01610	4101 11 11610	4101 11 21610
MF 16 x 1,25	14,75	70	22	12,0	9,0	1	4101 11 01612	4101 11 11612	4101 11 21612
MF 16 x 1,5	14,50	70	22	12,0	9,0	1	4101 11 01615	4101 11 11615	4101 11 21615
MF 18 x 1	17,00	80	22	14,0	11,0	1	4101 11 01810	4101 11 11810	4101 11 21810
MF 18 x 1,25	16,75	80	22	14,0	11,0	1	4101 11 01812	4101 11 11812	4101 11 21812
MF 18 x 1,5	16,50	80	22	14,0	11,0	1	4101 11 01815	4101 11 11815	4101 11 21815
MF 18 x 2	16,00	80	22	14,0	11,0	1	4101 11 01820	4101 11 11820	4101 11 21820
MF 20 x 1	19,85	80	22	16,0	12,0	1	4101 11 02010	4101 11 12010	4101 11 22010
MF 20 x 1,25	18,75	80	22	16,0	12,0	1	4101 11 02012	4101 11 12012	4101 11 22012
MF 20 x 1,5	18,50	80	22	16,0	12,0	1	4101 11 02015	4101 11 12015	4101 11 22015
MF 20 x 2	20,00	80	22	16,0	12,0	1	4101 11 02020	4101 11 12020	4101 11 22020
MF 22 x 1	21,00	80	22	18,0	14,5	1	4101 11 02210	4101 11 12210	4101 11 22210
MF 22 x 1,5	20,50	80	22	18,0	14,5	1	4101 11 02215	4101 11 12215	4101 11 22215
MF 22 x 2	20,00	80	22	18,0	14,5	1	4101 11 02220	4101 11 12220	4101 11 22220
MF 24 x 1	23,00	90	22	18,0	14,5	1	4101 11 02410	4101 11 12410	4101 11 22410
MF 24 x 1,25	22,75	90	22	18,0	14,5	1	4101 11 02412	4101 11 12412	4101 11 22412
MF 24 x 1,5	22,50	90	22	18,0	14,5	1	4101 11 02415	4101 11 12415	4101 11 22415
MF 24 x 2	22,00	90	22	18,0	14,5	1	4101 11 02420	4101 11 12420	4101 11 22420
MF 25 x 1,5	23,50	90	22	18,0	14,5	1	4101 11 02515	4101 11 12515	4101 11 22515
MF 26 x 1	25,00	90	22	18,0	14,5	1	4101 11 02610	4101 11 12610	4101 11 22610
MF 26 x 1,5	24,50	90	22	18,0	14,5	1	4101 11 02615	4101 11 12615	4101 11 22615
MF 26 x 2	24,00	90	22	18,0	14,5	1	4101 11 02620	4101 11 12620	4101 11 22620
MF 27 x 1,5	25,50	90	22	20,0	16,0	1	4101 11 02715	4101 11 12715	4101 11 22715
MF 27 x 2	25,00	90	22	20,0	16,0	1	4101 11 02720	4101 11 12720	4101 11 22720
MF 28 x 1,5	26,50	90	22	20,0	16,0	1	4101 11 02815	4101 11 12815	4101 11 22815
MF 28 x 2	26,00	90	22	20,0	16,0	1	4101 11 02820	4101 11 12820	4101 11 22820
MF 30 x 1	29,00	90	22	22,0	18,0	1	4101 11 03010	4101 11 13010	4101 11 23010



HANDGEWINDEBOHRER
HAND TAPS

Handgewindebohrer DIN 2181 HSS-G | MF
Hand taps DIN 2181 HSS-G | MF

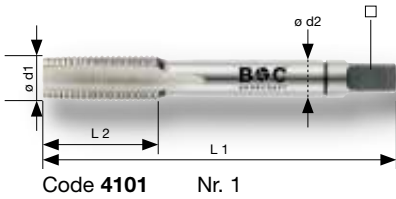

Code 4101 Nr. 1



Nr. 2

Ø d1 mm		L 1 mm	L 2 mm	Ø d2 mm			Satz / Set	Nr. 1	Nr. 2
MF 30 x 1,5	28,50	90	22	22,0	18,0	1	4101 11 03015	4101 11 13015	4101 11 23015
MF 30 x 2	28,00	90	22	22,0	18,0	1	4101 11 03020	4101 11 13020	4101 11 23020
MF 30 x 3	27,00	125	56	22,0	18,0	1	4101 11 03030	4101 11 13030	4101 11 23030
MF 32 x 1,5	30,50	90	22	22,0	18,0	1	4101 11 03215	4101 11 13215	4101 11 23215
MF 33 x 1,5	31,50	100	25	25,0	20,0	1	4101 11 03315	4101 11 13315	4101 11 23315
MF 33 x 2	31,00	100	25	25,0	20,0	1	4101 11 03320	4101 11 13320	4101 11 23320
MF 33 x 3	30,00	125	56	25,0	20,0	1	4101 11 03330	4101 11 13330	4101 11 23330
MF 34 x 1,5	32,50	100	25	28,0	22,0	1	4101 11 03415	4101 11 13415	4101 11 23415
MF 34 x 2	32,00	125	40	28,0	22,0	1	4101 11 03420	4101 11 13420	4101 11 23420
MF 35 x 1,5	33,50	100	25	28,0	22,0	1	4101 11 03515	4101 11 13515	4101 11 23515
MF 36 x 1,5	34,50	100	25	28,0	22,0	1	4101 11 03615	4101 11 13615	4101 11 23615
MF 36 x 2	34,00	125	40	28,0	22,0	1	4101 11 03620	4101 11 13620	4101 11 23620
MF 36 x 3	33,00	125	40	28,0	22,0	1	4101 11 03630	4101 11 13630	4101 11 23630
MF 38 x 1,5	36,50	100	25	28,0	22,0	1	4101 11 03815	4101 11 13815	4101 11 23815
MF 39 x 1,5	37,50	110	25	32,0	24,0	1	4101 11 03915	4101 11 13915	4101 11 23915
MF 39 x 2	37,00	125	40	32,0	24,0	1	4101 11 03920	4101 11 13920	4101 11 23920
MF 39 x 3	36,00	125	40	32,0	24,0	1	4101 11 03930	4101 11 13930	4101 11 23930
MF 40 x 1,5	38,50	110	25	32,0	24,0	1	4101 11 04015	4101 11 14015	4101 11 24015
MF 40 x 2	38,00	125	40	32,0	24,0	1	4101 11 04020	4101 11 14020	4101 11 24020
MF 40 x 3	37,00	125	40	32,0	24,0	1	4101 11 04030	4101 11 14030	4101 11 24030
MF 42 x 1,5	40,50	110	25	32,0	24,0	1	4101 11 04215	4101 11 14215	4101 11 24215
MF 42 x 2	40,00	125	40	32,0	24,0	1	4101 11 04220	4101 11 14220	4101 11 24220
MF 42 x 3	39,00	125	40	32,0	24,0	1	4101 11 04230	4101 11 14230	4101 11 24230
MF 45 x 1,5	43,50	110	25	36,0	29,0	1	4101 11 04515	4101 11 14515	4101 11 24515
MF 45 x 2	43,00	125	40	36,0	29,0	1	4101 11 04520	4101 11 14520	4101 11 24520
MF 45 x 3	42,00	125	40	36,0	29,0	1	4101 11 04530	4101 11 14530	4101 11 24530
MF 48 x 1,5	46,50	140	40	36,0	29,0	1	4101 11 04815	4101 11 14815	4101 11 24815
MF 48 x 2	46,00	140	40	36,0	29,0	1	4101 11 04820	4101 11 14820	4101 11 24820
MF 48 x 3	45,00	140	40	36,0	29,0	1	4101 11 04830	4101 11 14830	4101 11 24830
MF 50 x 1,5	48,50	140	40	36,0	29,0	1	4101 11 05015	4101 11 15015	4101 11 25015
MF 50 x 2	48,00	140	40	36,0	29,0	1	4101 11 05020	4101 11 15020	4101 11 25020
MF 50 x 3	47,00	140	40	36,0	29,0	1	4101 11 05030	4101 11 15030	4101 11 25030
MF 52 x 1,5	50,50	140	40	40,0	32,0	1	4101 11 05215	4101 11 15215	4101 11 25215
MF 52 x 2	50,00	140	40	40,0	32,0	1	4101 11 05220	4101 11 15220	4101 11 25220
MF 52 x 3	49,00	140	40	40,0	32,0	1	4101 11 05230	4101 11 15230	4101 11 25230
MF 63 x 1,5	61,50	160	32	50,0	39,0	1	4101 11 06315	4101 11 16315	4101 11 26315

BC Industrie-Kassette / BC Metal-Box

Bezeichnung Description	Teile Pieces	Inhalt Content	Artikel-Nr. Part-No.
GW 43	43 MF3 – MF 20	HGB-Sätze 2-tlg. / Hand-tap sets 2 pcs., DIN 2181 HSS-G, Schneideisen / Circular dies DIN EN 22568 HSS-G, MF3 x 0,35 · MF4 x 0,5 · MF5 x 0,5 · MF6 x 0,75 · MF8 x 1,0 · MF10 x 1,0 · MF12 x 1,5 · MF14 x 1,5 · MF16 x 1,5 · MF18 x 1,50 · MF20 x 1,5 Halter / Holders DIN 225, 20 x 5 · 20 x 7 · 25 x 9 · 30 x 11 · 38 x 10 · 45 x 14, Windeisen / Tap wrenches DIN 1814 Gr. 1 + 3, Gewindecshablone / Gauge, Schraubendreher / Screwdriver	6000 14 10043



BC Holzkassette / BC Wooden-Box

Bezeichnung Description	Teile Pieces	Inhalt Content	Artikel-Nr. Part-No.
GWH MF	47 MF6 – MF24	HGB-Sätze 2-tlg. / Hand-tap sets 2 pcs. DIN 2181 + Schneideisen / Circular dies DIN EN 22568 MF6 x 0,75 · MF8 x 0,75 · MF8 x 1,0 · MF10 x 1,0 · MF12 x 1,0 · MF12 x 1,5 · MF14 x 1,25 · MF14 x 1,5 · MF16 x 1,5 · MF18 x 1,50 · MF20 x 1,5 · MF22 x 1,5 · MF24 x 1,5, Halter / Holders DIN 225 20 x 7 · 25 x 9 · 30 x 11 · 38 x 10 · 45 x 14 · 55 x 16 Windeisen / Tap wrenches DIN 1814, Gr. 1 + 4	6000 14 50047



HANDGEWINDEBOHRER
HAND TAPS
MF

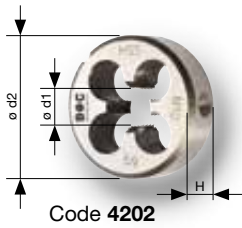

Für den allgemeinen Einsatz in gut zerspanbaren Werkstoffen mit einer Zugfestigkeit bis 800 N/mm².

- Zum Schneiden von metrischen ISO-Feingewinden DIN 13
- Form B = geschlossen, vorgeschlitzt

For general use in good machinable materials up to 800 N/mm² (22,5 HRC) tensile strength.

- For cutting metric fine ISO-Thread DIN 13
- Form B = preslotted, closed

Ø d1 mm	Bolzen / Bolt mm	Ø d2 mm	H mm		Artikel-Nr. Part-No.
MF 3 x 0,35	2,94	20	5	1	4202 11 00303
MF 4 x 0,35	3,94	20	5	1	4202 11 00403
MF 4 x 0,5	3,93	20	5	1	4202 11 00405
MF 5 x 0,5	4,93	20	5	1	4202 11 00505
MF 5 x 0,75	4,91	20	7	1	4202 11 00507
MF 6 x 0,5	5,93	20	5	1	4202 11 00605
MF 6 x 0,75	5,90	20	7	1	4202 11 00607
MF 7 x 0,75	6,90	20	7	1	4202 11 00707
MF 8 x 0,5	7,93	25	9	1	4202 11 00805
MF 8 x 0,75	7,90	25	9	1	4202 11 00807
MF 8 x 1	7,83	25	9	1	4202 11 00810
MF 9 x 0,75	8,90	25	9	1	4202 11 00907
MF 9 x 1	8,88	25	9	1	4202 11 00910
MF 10 x 0,75	9,90	30	11	1	4202 11 01007
MF 10 x 1	9,88	30	11	1	4202 11 01010
MF 10 x 1,25	9,86	30	11	1	4202 11 01012
MF 11 x 1	10,88	30	11	1	4202 11 01110
MF 11 x 1,25	10,86	30	11	1	4202 11 01112
MF 12 x 0,75	11,90	38	10	1	4202 11 01207
MF 12 x 1	11,88	38	10	1	4202 11 01210
MF 12 x 1,25	11,86	38	10	1	4202 11 01212
MF 12 x 1,5	11,85	38	10	1	4202 11 01215
MF 13 x 1	12,88	38	10	1	4202 11 01310
MF 13 x 1,5	12,85	38	10	1	4202 11 01315
MF 14 x 0,75	13,90	38	10	1	4202 11 01407
MF 14 x 1	13,88	38	10	1	4202 11 01410
MF 14 x 1,25	13,86	38	10	1	4202 11 01412
MF 14 x 1,5	13,85	38	10	1	4202 11 01415
MF 15 x 1	14,88	38	10	1	4202 11 01510
MF 15 x 1,5	14,85	38	10	1	4202 11 01515
MF 16 x 1	15,88	45	14	1	4202 11 01610
MF 16 x 1,25	15,86	45	14	1	4202 11 01612
MF 16 x 1,5	15,85	45	14	1	4202 11 01615
MF 18 x 1	17,88	45	14	1	4202 11 01810
MF 18 x 1,25	17,86	45	14	1	4202 11 01812
MF 18 x 1,5	17,85	45	14	1	4202 11 01815
MF 18 x 2	17,82	45	14	1	4202 11 01820
MF 20 x 1	19,85	45	14	1	4202 11 02010
MF 20 x 1,25	19,86	45	14	1	4202 11 02012
MF 20 x 1,5	19,85	45	14	1	4202 11 02015
MF 20 x 2	19,82	45	14	1	4202 11 02020
MF 22 x 1	21,88	55	16	1	4202 11 02210
MF 22 x 1,5	21,85	55	16	1	4202 11 02215
MF 22 x 2	21,82	55	16	1	4202 11 02220
MF 24 x 1	23,88	55	16	1	4202 11 02410
MF 24 x 1,25	23,86	55	16	1	4202 11 02412
MF 24 x 1,5	23,85	55	16	1	4202 11 02415
MF 24 x 2	22,82	55	16	1	4202 11 02420
MF 25 x 1,5	24,85	55	16	1	4202 11 02515
MF 26 x 1	25,88	55	16	1	4202 11 02610
MF 26 x 1,5	25,85	55	16	1	4202 11 02615
MF 26 x 2	25,82	55	16	1	4202 11 02620
MF 27 x 1,5	26,85	65	18	1	4202 11 02715
MF 27 x 2	26,82	65	18	1	4202 11 02720
MF 28 x 1,5	27,85	65	18	1	4202 11 02815
MF 28 x 2	27,82	65	18	1	4202 11 02820



MF

SCHNEIDEISEN
DIES

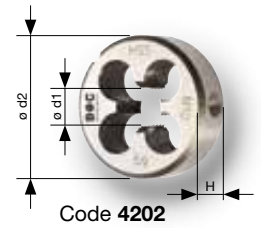

Ø d1 mm	Bolzen / Bolt mm	Ø d2 mm	H mm		Artikel-Nr. Part-No.
MF 30 x 1	29,88	65	18	1	4202 11 03010
MF 30 x 1,5	29,85	65	18	1	4202 11 03015
MF 30 x 2	29,82	65	18	1	4202 11 03020
MF 30 x 3	29,76	65	25	1	4202 11 03030
MF 32 x 1,5	31,85	65	18	1	4202 11 03215
MF 33 x 1,5	32,85	65	18	1	4202 11 03315
MF 33 x 2	32,82	65	18	1	4202 11 03320
MF 33 x 3	32,76	65	25	1	4202 11 03330
MF 34 x 1,5	33,85	65	18	1	4202 11 03415
MF 34 x 2	33,82	65	18	1	4202 11 03420
MF 35 x 1,5	34,85	65	18	1	4202 11 03515
MF 36 x 1,5	35,85	65	18	1	4202 11 03615
MF 36 x 2	35,82	65	18	1	4202 11 03620
MF 36 x 3	35,76	65	25	1	4202 11 03630
MF 38 x 1,5	37,85	75	20	1	4202 11 03815
MF 39 x 1,5	38,85	75	30	1	4202 11 03915
MF 39 x 2	38,82	75	20	1	4202 11 03920
MF 39 x 3	38,76	75	30	1	4202 11 03930
MF 40 x 1,5	39,85	75	20	1	4202 11 04015
MF 40 x 2	39,82	75	20	1	4202 11 04020
MF 40 x 3	39,76	75	30	1	4202 11 04030
MF 42 x 1,5	41,85	75	20	1	4202 11 04215
MF 42 x 2	41,82	75	20	1	4202 11 04220
MF 42 x 3	41,76	75	30	1	4202 11 04230
MF 45 x 1,5	44,85	90	22	1	4202 11 04515
MF 45 x 2	44,82	90	22	1	4202 11 04520
MF 45 x 3	44,76	90	36	1	4202 11 04530
MF 48 x 1,5	47,85	90	22	1	4202 11 04815
MF 48 x 2	47,82	90	22	1	4202 11 04820
MF 48 x 3	47,46	90	36	1	4202 11 04830
MF 50 x 1,5	49,85	90	22	1	4202 11 05015
MF 50 x 2	49,82	90	22	1	4202 11 05020
MF 50 x 3	49,76	90	36	1	4202 11 05030
MF 52 x 1,5	51,85	90	22	1	4202 11 05215
MF 52 x 2	51,82	90	22	1	4202 11 05220
MF 52 x 3	51,76	90	36	1	4202 11 05230
MF 63 x 1,5	62,92	105	22	1	4202 11 06315



MF

SCHNEIDEISEN
DIES

MF | Einschnittgewindebohrer DIN 2181 HSS-G
Short machine taps DIN 2181 HSS-G

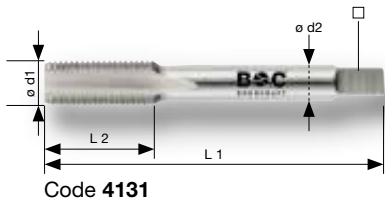

Code	P					M	K	N			
	1.1	2.1	3.1	4.1	5.1	1.1 - 4.1	2.1 - 2.2 / 4.1 - 4.2	1.1 - 1.3	1.4 - 1.6	2.1 - 2.5	4.2
4131	☺	☺					☺	☺			☺

- Zum Schneiden von metrischen ISO-Feingewinden DIN 13
- Für Hand- und Maschinengebrauch
- 2 – 3 Gang Anschnitt für Durchgangs- und Sackloch
- For cutting metric fine ISO-Thread DIN 13
- For manual and machine use
- 2 – 3 threads lead for through- and blind hole

Ø d1 mm		L 1 mm	L 2 mm	Ø d2 mm	□ mm		Artikel-Nr. Part-No.
MF 4 x 0,35	3,65	45,0	10,0	4,5	3,4	1	4131 03 00403
MF 5 x 0,75	4,25	50,0	12,0	6,0	4,9	1	4131 03 00507
MF 6 x 0,75	5,20	50,0	14,0	6,0	4,9	1	4131 03 00607
MF 7 x 0,75	6,20	50,0	14,0	6,0	4,9	1	4131 03 00707
MF 8 x 0,5	7,50	50,0	19,0	6,0	4,9	1	4131 03 00805
MF 8 x 0,75	7,20	50,0	19,0	6,0	4,9	1	4131 03 00807
MF 8 x 1	7,00	56,0	22,0	6,0	4,9	1	4131 03 00810
MF 9 x 0,75	8,20	50,0	19,0	7,0	4,9	1	4131 03 00907
MF 9 x 1	8,00	63,0	20,0	7,0	5,5	1	4131 03 00910
MF 10 x 0,75	9,20	63,0	20,0	7,0	5,5	1	4131 03 01007
MF 10 x 1	9,00	63,0	20,0	7,0	5,5	1	4131 03 01010
MF 10 x 1,25	8,80	70,0	24,0	7,0	5,5	1	4131 03 01012
MF 11 x 1	10,00	63,0	20,0	8,0	6,2	1	4131 03 01110
MF 11 x 1,25	9,80	63,0	22,0	8,0	6,2	1	4131 03 01112
MF 12 x 0,75	11,20	70,0	22,0	9,0	7,0	1	4131 03 01207
MF 12 x 1	11,00	70,0	22,0	9,0	7,0	1	4131 03 01210
MF 12 x 1,25	10,80	70,0	22,0	9,0	7,0	1	4131 03 01212
MF 12 x 1,5	10,50	70,0	22,0	9,0	7,0	1	4131 03 01215
MF 13 x 1	12,00	70,0	22,0	11,0	9,0	1	4131 03 01310
MF 13 x 1,5	11,50	70,0	22,0	11,0	9,0	1	4131 03 01315
MF 14 x 0,75	13,25	70,0	22,0	11,0	9,0	1	4131 03 01407
MF 14 x 1	13,00	70,0	22,0	11,0	9,0	1	4131 03 01410
MF 14 x 1,25	12,80	70,0	22,0	11,0	9,0	1	4131 03 01412
MF 14 x 1,5	12,50	70,0	22,0	11,0	9,0	1	4131 03 01415
MF 15 x 1	14,00	70,0	22,0	12,0	9,0	1	4131 03 01510
MF 15 x 1,5	13,50	70,0	22,0	12,0	9,0	1	4131 03 01515
MF 16 x 1	15,00	70,0	22,0	12,0	9,0	1	4131 03 01610
MF 16 x 1,5	14,50	70,0	22,0	12,0	9,0	1	4131 03 01615
MF 18 x 1	17,00	80,0	22,0	14,0	11,0	1	4131 03 01810
MF 18 x 1,25	16,75	80,0	22,0	14,0	11,0	1	4131 03 01812
MF 18 x 1,5	16,50	80,0	22,0	14,0	11,0	1	4131 03 01815
MF 20 x 1,25	18,75	80,0	22,0	16,0	12,0	1	4131 03 02012
MF 20 x 1,5	18,50	80,0	22,0	16,0	12,0	1	4131 03 02015
MF 20 x 2	20,00	80,0	22,0	16,0	12,0	1	4131 03 02020
MF 22 x 1	21,00	80,0	22,0	18,0	14,5	1	4131 03 02210
MF 22 x 1,5	20,50	80,0	22,0	18,0	14,5	1	4131 03 02215
MF 22 x 2	20,00	80,0	22,0	18,0	14,5	1	4131 03 02220
MF 24 x 1	23,00	90,0	22,0	18,0	14,5	1	4131 03 02410
MF 24 x 1,25	22,75	90,0	22,0	18,0	14,5	1	4131 03 02412
MF 24 x 1,5	22,50	90,0	22,0	18,0	14,5	1	4131 03 02415
MF 24 x 2	22,00	90,0	22,0	18,0	14,5	1	4131 03 02420
MF 25 x 1,5	23,50	90,0	22,0	18,0	14,5	1	4131 03 02515
MF 26 x 1	25,00	90,0	22,0	18,0	14,5	1	4131 03 02610
MF 26 x 1,5	24,50	90,0	22,0	18,0	14,5	1	4131 03 02615
MF 26 x 2	24,00	90,0	22,0	18,0	14,5	1	4131 03 02620
MF 27 x 1,5	25,50	90,0	22,0	20,0	16,0	1	4131 03 02715
MF 27 x 2	25,00	90,0	22,0	20,0	16,0	1	4131 03 02720
MF 28 x 1,5	26,50	90,0	22,0	20,0	16,0	1	4131 03 02815
MF 28 x 2	26,00	90,0	22,0	20,0	16,0	1	4131 03 02820
MF 30 x 1	29,00	90,0	22,0	22,0	18,0	1	4131 03 03010
MF 30 x 1,5	28,50	90,0	22,0	22,0	18,0	1	4131 03 03015
MF 30 x 2	28,00	90,0	22,0	22,0	18,0	1	4131 03 03020
MF 30 x 3	27,00	125,0	56,0	22,0	18,0	1	4131 03 03030
MF 32 x 1,5	30,50	90,0	22,0	22,0	18,0	1	4131 03 03215

EINSCHNITTGEWINDEBOHRER
SHORT MACHINE TAPS

Maschinengewindebohrer DIN 374 HSS-E (Co5) | MF

Machine taps DIN 374 HSS-E (Co5) | MF



Code	P					M	K	N			
	1.1	2.1	3.1	4.1	5.1	1.1 - 4.1	2.1 - 2.2 / 4.1 - 4.2	1.1 - 1.3	1.4 - 1.6	2.1 - 2.5	4.2
4165 · 4166	☉	☉	☉			☉	☉	☉	☉	☉	☉

- Zum Schneiden von metrischen ISO-Feingewinden DIN 13
- Form B = 4 – 5 Gang Anschnitt mit Schälanschnitt
- Form C 35° = 2 – 3 Gang Anschnitt mit Rechtsspirale 35°
- For cutting metric fine ISO-Thread DIN 13
- Form B = 4 – 5 threads lead with spiral point (gun nose)
- Form C 35° = 2 – 3 threads lead with spiral flute 35°

Ø d1 mm	☉	L 1 mm	L 2 mm		Ø d2 mm	□ mm	☉	B		C 35°	
			B	C 35°				Artikel-Nr. Part-No.	Artikel-Nr. Part-No.		
MF 3 x 0,35	2,60	56	9	5	2,2	-	1	4165 03 00303	4166 03 00303		
MF 4 x 0,5	3,50	63	10	5	2,8	2,1	1	4165 03 00405	4166 03 00405		
MF 5 x 0,5	4,50	70	12	5	3,5	2,7	1	4165 03 00505	4166 03 00505		
MF 6 x 0,5	5,50	80	14	5	4,5	3,4	1	4165 03 00605	4166 03 00605		
MF 6 x 0,75	5,20	80	14	8	4,5	3,4	1	4165 03 00607	4166 03 00607		
MF 8 x 0,75	7,20	80	19	8	6,0	4,9	1	4165 03 00807	4166 03 00807		
MF 8 x 1	7,00	90	22	10	6,0	4,9	1	4165 03 00810	4166 03 00810		
MF 10 x 0,75	9,20	90	20	10	7,0	5,5	1	4165 03 01007	4166 03 01007		
MF 10 x 1	9,00	90	20	10	7,0	5,5	1	4165 03 01010	4166 03 01010		
MF 10 x 1,25	8,80	100	24	16	7,0	5,5	1	4165 03 01012	4166 03 01012		
MF 12 x 1	11,00	100	22	11	9,0	7,0	1	4165 03 01210	4166 03 01210		
MF 12 x 1,25	10,80	100	22	15	9,0	7,0	1	4165 03 01212	4166 03 01212		
MF 12 x 1,5	10,50	100	22	15	9,0	7,0	1	4165 03 01215	4166 03 01215		
MF 14 x 1	13,00	100	22	11	11,0	9,0	1	4165 03 01410	4166 03 01410		
MF 14 x 1,25	12,80	100	22	15	11,0	9,0	1	4165 03 01412	4166 03 01412		
MF 14 x 1,5	12,50	100	22	15	11,0	9,0	1	4165 03 01415	4166 03 01415		
MF 16 x 1	15,00	100	22	12	12,0	9,0	1	4165 03 01610	4166 03 01610		
MF 16 x 1,25	14,75	100	22	15	12,0	9,0	1	4165 03 01612	4166 03 01612		
MF 16 x 1,5	14,50	100	22	15	12,0	9,0	1	4165 03 01615	4166 03 01615		
MF 18 x 1	17,00	110	25	17	14,0	11,0	1	4165 03 01810	4166 03 01810		
MF 18 x 1,5	16,50	110	25	17	14,0	11,0	1	4165 03 01815	4166 03 01815		
MF 18 x 2	16,00	125	25	20	14,0	11,0	1	4165 03 01820	4166 03 01820		
MF 20 x 1	19,00	125	25	14	16,0	12,0	1	4165 03 02010	4166 03 02010		
MF 20 x 1,5	18,50	125	25	17	16,0	12,0	1	4165 03 02015	4166 03 02015		
MF 20 x 2	18,00	140	25	20	16,0	12,0	1	4165 03 02020	4166 03 02020		
MF 22 x 1	21,00	125	25	14	18,0	14,5	1	4165 03 02210	4166 03 02210		
MF 22 x 1,5	20,50	125	25	17	18,0	14,5	1	4165 03 02215	4166 03 02215		
MF 22 x 2	20,00	140	34	20	18,0	14,5	1	4165 03 02220	4166 03 02220		
MF 24 x 1	23,00	140	28	15	18,0	14,5	1	4165 03 02410	4166 03 02410		
MF 24 x 1,5	22,50	140	28	20	18,0	14,5	1	4165 03 02415	4166 03 02415		
MF 24 x 2	22,00	140	28	20	18,0	14,5	1	4165 03 02420	4166 03 02420		
MF 25 x 1,5	23,50	140	28	20	18,0	14,5	1	4165 03 02515	4166 03 02515		
MF 26 x 1,5	24,50	140	28	20	18,0	14,5	1	4165 03 02615	4166 03 02615		
MF 27 x 1,5	25,50	140	28	20	20,0	16,0	1	4165 03 02715	4166 03 02715		
MF 28 x 1,5	26,50	140	28	20	20,0	16,0	1	4165 03 02815	4166 03 02815		
MF 30 x 1,5	28,50	150	28	22	22,0	18,0	1	4165 03 03015	4166 03 03015		
MF 30 x 2	28,00	150	28	22	22,0	18,0	1	4165 03 03020	4166 03 03020		

MASCHINENGEWINDEBOHRER
MACHINE TAPS

MF UNI Maschinengewindebohrer DIN 374 HSS-E (Co5)

UNI machine taps DIN 374 HSS-E (Co5)



Code 4139



Code	P					M	K	N			
	1.1	2.1	3.1	4.1	5.1	1.1 - 4.1	2.1 - 2.2 / 4.1 - 4.2	1.1 - 1.3	1.4 - 1.6	2.1 - 2.5	4.2
4139	☉	☉	☉	☉	☉		☉	☉	☉	☉	☉

Für den universellen Einsatz in allgemeinen Baustählen, Automatenstahl, unlegierten Einsatzstählen und Aluminiumlegierungen (kurzspanend).

- Zum Schneiden von metrischen ISO-Feingewinden DIN 13
- Form C = 2 - 3 Gang Anschnitt
- Für Durchgangs- und Sackloch

For universal use in general structural steel, free-cutting steel, unalloyed case hardening steel and aluminium-alloys (short chipping).

- For cutting metric fine ISO-Thread DIN 13
- Form C = 2 - 3 threads lead
- For through- and blind hole

Ø d1 mm		L 1 mm	L 2 mm	Ø d2 mm			Artikel-Nr. Part-No.
MF 6 x 0,75	5,2	80	15	4,5	3,4	1	4139 03 00607
MF 8 x 1	7,0	90	18	6,0	4,9	1	4139 03 00810
MF 10 x 1	9,0	90	20	7,0	5,5	1	4139 03 01010
MF 12 x 1	11,0	100	21	9,0	7,0	1	4139 03 01210
MF 12 x 1,25	10,8	100	21	9,0	7,0	1	4139 03 01212
MF 14 x 1,25	10,5	100	21	9,0	7,0	1	4139 03 01215
MF 14 x 1,5	12,8	100	21	11,0	9,0	1	4139 03 01412
MF 16 x 1,5	12,5	100	21	11,0	9,0	1	4139 03 01415
MF 18 x 1,5	14,5	100	21	12,0	9,0	1	4139 03 01615
MF 20 x 1,5	16,5	110	24	14,0	11,0	1	4139 03 01815
MF 22 x 1,5	18,5	125	24	16,0	12,0	1	4139 03 02015
MF 22 x 2	20,5	125	24	18,0	14,5	1	4139 03 02215
MF 24 x 1,5	22,5	140	26	18,0	14,5	1	4139 03 02415
MF 26 x 1,5	24,5	140	26	18,0	14,5	1	4139 03 02615
MF 30 x 1,5	28,5	150	28	22,0	18,0	1	4139 03 03015



MF

 MASCHINENGEWINDEBOHRER
MACHINE TAPS

INOX Maschinengewindebohrer DIN 374 HSS-E (Co5) VAP | MF

INOX machine taps DIN 374 HSS-E (Co5) VAP | MF



Code 4146



Code 4156

MF	DIN 374	HSS-E Co5	VAP	Blauring	B	3 x D	FORM C	40°	2,5 x D
VA INOX	ISO2 6H	60°	1000 N/mm²						

Code	P					M	K	N			
	1.1	2.1	3.1	4.1	5.1	1.1 - 2.1	2.1 - 2.2 / 4.1 - 4.2	1.1 - 1.3	1.4 - 1.6	2.1 - 2.5	4.2
4146 · 4156			⊕	⊕	⊕	⊕					

Spezielle Schneidengeometrie und vaporisierte Oberfläche, besonders für die Bearbeitung von VA- und rostfreien Stählen geeignet.

- Zum Schneiden von metrischen ISO-Feingewinden DIN 13
- Form B = 4 – 5 Gang Anschnitt mit Schälanschnitt
- Form C 40° = 2 – 3 Gang Anschnitt mit Rechtsspirale 40°

Special cutting edge geometry and vap. surface, especially suitable for stainless steels like AISI 304 and 316.

- For cutting metric fine ISO-Thread DIN 13
- Form B = 4 – 5 threads lead with spiral point (gun nose)
- Form C 40° = 2 – 3 threads lead with spiral flute 40°

Ø d1 mm		L 1 mm	L 2 mm		Ø d2 mm		mm	B		C 40°	
			B	C 40°				Artikel-Nr. Part-No.	Artikel-Nr. Part-No.		
MF 6 x 0,75	5,2	80	14	8	4,5	3,4	1	4146 03 00607	4156 03 00607		
MF 8 x 0,75	7,2	80	19	8	6,0	4,9	1	4146 03 00807	4156 03 00807		
MF 8 x 1	7,0	90	22	10	6,0	4,9	1	4146 03 00810	4156 03 00810		
MF 10 x 1	9,0	90	20	10	7,0	5,5	1	4146 03 01010	4156 03 01010		
MF 12 x 1	11,0	100	22	11	9,0	7,0	1	4146 03 01210	4156 03 01210		
MF 12 x 1,5	10,5	100	22	15	9,0	7,0	1	4146 03 01215	4156 03 01215		
MF 14 x 1,5	12,5	100	22	15	11,0	9,0	1	4146 03 01415	4156 03 01415		
MF 16 x 1,5	14,5	100	22	15	12,0	9,0	1	4146 03 01615	4156 03 01615		
MF 18 x 1,5	16,5	110	25	17	14,0	11,0	1	4146 03 01815	4156 03 01815		
MF 20 x 1,5	18,5	125	25	17	16,0	12,0	1	4146 03 02015	4156 03 02015		



MASCHINENGEWINDEBOHRER
MACHINE TAPS
MF

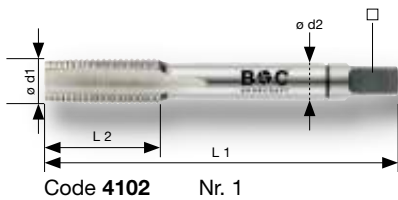

Nr. 2



G **DIN** **HSS**  **800**
 BSP 5157 G 55° N/mm²

Für den allgemeinen Einsatz in gut zerspanbaren Werkstoffen mit einer Zugfestigkeit bis 800 N/mm².

- Zum Schneiden von Whitworth Rohrgewinden nach DIN ISO 228/1 für Durchgangs- und Sackloch.
- Nr. 1 Vorschneider 5 – 6 Gang Anschnitt
- Nr. 2 Fertigschneider 2 – 3 Gang Anschnitt

For general use in good machinable materials up to 800 N/mm² (22,5 HRC) tensile strength.

- For cutting whitworth pipe threads acc. to DIN ISO 228/1 for through- and blind hole.
- No. 1 Rougher 5 – 6 threads lead
- No. 2 Finisher 2 – 3 threads lead

Ø d1		L 1 mm	L 2 mm	Ø d2 mm			Satz / Set	Nr. 1	Nr. 2
G 1/8" x 28	8,80	63	20	7	5,5	1	4102 11 00018	4102 11 10018	4102 11 20018
G 1/4" x 19	11,80	70	22	11	9,0	1	4102 11 00014	4102 11 10014	4102 11 20014
G 3/8" x 19	15,25	70	22	12	9,0	1	4102 11 00038	4102 11 10038	4102 11 20038
G 1/2" x 14	19,00	80	22	16	12,0	1	4102 11 00012	4102 11 10012	4102 11 20012
G 5/8" x 14	21,00	80	22	18	14,5	1	4102 11 00058	4102 11 10058	4102 11 20058
G 3/4" x 14	24,50	90	22	20	16,0	1	4102 11 00034	4102 11 10034	4102 11 20034
G 7/8" x 14	28,25	90	22	22	18,0	1	4102 11 00078	4102 11 10078	4102 11 20078
G 1" x 11	30,75	100	25	25	20,0	1	4102 11 00100	4102 11 10100	4102 11 20100
G 1.1/4" x 11	39,50	125	40	40	24,0	1	4102 11 00114	4102 11 10114	4102 11 20114
G 1.1/2" x 11	45,00	140	40	40	29,0	1	4102 11 00112	4102 11 10112	4102 11 20112
G 2" x 11	57,00	160	40	40	35,0	1	4102 11 00200	4102 11 10200	4102 11 20200

BC Industrie-Kassette / BC Metal-Box

Bezeichnung Description	Teile Pieces	Inhalt Content	Artikel-Nr. Part-No.
GW 28	28 G · BSP 1/8" – G 1"	HGB-Sätze 2-tlg. / Hand-tap sets of 2 pcs. DIN 5157 HSS + Schneideisen / Circular dies DIN EN 24231 HSS G 1/8" · G 1/4" · G 3/8" · G 1/2" · G 3/4" · G 1" Halter / Holders DIN 225 30 x 11 · 38 x 10 · 45 x 14 · 55 x 16 · 65 x 18 Windeisen / Tap wrenches DIN 1814 Gr. 1 + 3 + 5 Gewindeschablone / Gauge, Schraubendreher / Screwdriver	6000 14 10028

BC Holzkassette / BC Wooden-Box

Bezeichnung Description	Teile Pieces	Inhalt Content	Artikel-Nr. Part-No.
GWH G	25 G · BSP 1/8" – G 1"	HGB-Sätze 2-tlg. / Hand-tap sets 2 pcs. DIN 5157 + Schneideisen / Circular dies DIN EN 24231 HSS G 1/8" · G 1/4" · G 3/8" · G 1/2" · G 3/4" · G 1" Halter / Holders DIN 225 30 x 11 · 38 x 10 · 45 x 14 · 55 x 16 · 65 x 18 Windeisen / Tap wrenches DIN 1814, Gr. 3 + 5	6000 14 50026



GW 28



GWH G

HANDGEWINDEBOHRER
HAND TAPS

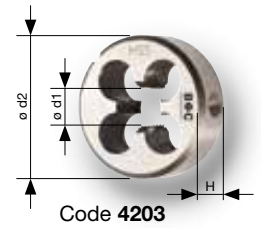

Für den allgemeinen Einsatz in gut zerspanbaren Werkstoffen mit einer Zugfestigkeit bis 800 N/mm².

- Zum Schneiden von Whitworth Rohrgewinden nach DIN ISO 228/1
- Form B = geschlossen, vorgeschlitzt

For general use in good machinable materials up to 800 N/mm² (22,5 HRC) tensile strength.

- For cutting whitworth pipe threads acc. to DIN ISO 228/1
- Form B = preslotted, closed

Ø d1	Bolzen / Bolt mm	Ø d2 mm	H mm		Artikel-Nr. Part-No.
G 1/8" x 28	9,62	30	11	1	4203 11 00018
G 1/4" x 19	13,03	38	10	1	4203 11 00014
G 3/8" x 19	16,53	45	14	1	4203 11 00038
G 1/2" x 14	20,81	45	14	1	4203 11 00012
G 5/8" x 14	22,77	55	16	1	4203 11 00058
G 3/4" x 14	26,30	55	16	1	4203 11 00034
G 7/8" x 14	30,06	65	18	1	4203 11 00078
G 1" x 11	33,07	65	18	1	4203 11 00100
G 1.1/4" x 11	41,73	75	20	1	4203 11 00114
G 1.1/2" x 11	47,62	90	22	1	4203 11 00112
G 2" x 11	59,43	105	22	1	4203 11 00200



G

SCHNEIDEISEN
DIES

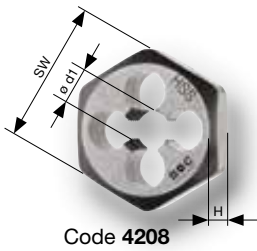

Für den allgemeinen Einsatz in gut zerspanbaren Werkstoffen mit einer Zugfestigkeit bis 800 N/mm².

- Zum Schneiden von Whitworth Rohrgewinden nach DIN ISO 228/1
- Ideal zur Verwendung an schwer zugänglichen Stellen

For general use in good machinable materials up to 800 N/mm² (22,5 HRC) tensile strength.

- For cutting whitworth pipe threads acc. to DIN ISO 228
- Ideal for operations at difficult accessible places

Ø d1	Bolzen / Bolt mm	SW mm	H mm		Artikel-Nr. Part-No.
G 1/8" x 28	9,62	27	11	1	4208 11 00018
G 1/4" x 19	13,03	36	10	1	4208 11 00014
G 3/8" x 19	16,53	41	14	1	4208 11 00038
G 1/2" x 14	20,81	41	14	1	4208 11 00012
G 5/8" x 14	22,77	50	16	1	4208 11 00058
G 3/4" x 14	26,30	50	16	1	4208 11 00034
G 7/8" x 14	30,06	60	18	1	4208 11 00078
G 1" x 11	33,07	60	18	1	4208 11 00100



G

SCHNEIDMUTTERN
 HEXAGON DIE NUTS

Einschnittgewindebohrer DIN 5157 HSS-G · BSP | G
Short machine taps DIN 5157 HSS-G · BSP | G

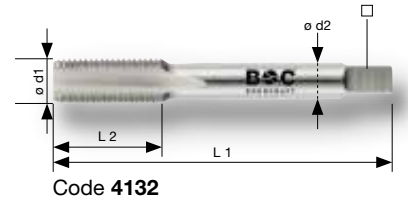

Code	P					M	K	N			
	1.1	2.1	3.1	4.1	5.1	1.1 - 4.1	2.1 - 2.2 / 4.1 - 4.2	1.1 - 1.3	1.4 - 1.6	2.1 - 2.5	4.2
4132	⊕	⊕					⊕	⊕			⊕

- Zum Schneiden von Whitworth Rohrgewinden nach DIN ISO 228/1
- Für Hand- und Maschinengebrauch
- 2 – 3 Gang Anschnitt für Durchgangs- und Sackloch

- For cutting whitworth pipe threads acc. to DIN ISO 228/1
- For manual and machine use
- 2 – 3 threads lead for through- and blind hole

Ø d1		L 1 mm	L 2 mm	Ø d2 mm	□ mm		Artikel-Nr. Part-No.
G 1/8" x 28	8,80	63	20	7,0	5,5	1	4132 03 00018
G 1/4" x 19	11,80	70	22	11,0	9,0	1	4132 03 00014
G 3/8" x 19	15,25	70	22	12,0	9,0	1	4132 03 00038
G 1/2" x 14	19,00	80	22	16,0	12,0	1	4132 03 00012
G 3/4" x 14	24,50	90	22	20,0	16,0	1	4132 03 00034
G 1" x 11	30,75	100	25	25,0	20,0	1	4132 03 00100
G 1.1/4" x 11	39,50	125	40	40,0	24,0	1	4132 03 00114
G 1.1/2" x 11	45,25	140	40	40,0	29,0	1	4132 03 00112
G 2" x 11	57,00	160	40	40,0	35,0	1	4132 03 00200



EINSCHNITTGEWINDEBOHRER
SHORT MACHINE TAPS



Code 4175



Code 4176

G
BSP
DIN
5156
HSS-E
Co5
 B
 3 x D

FORM
C
 35°
 2,5 x D

55°

Code	P					M	K	N			
	1.1	2.1	3.1	4.1	5.1	1.1 - 4.1	2.1 - 2.2 / 4.1 - 4.2	1.1 - 1.3	1.4 - 1.6	2.1 - 2.5	4.2
4175 · 4176	⊕	⊕	⊕				⊕	⊕	⊕	⊕	⊕

- Zum Schneiden von Whitworth Rohrgewinden nach DIN ISO 228/1
- Form B = 4 – 5 Gang Anschnitt mit Schälanschnitt
- Form C 35° = 2 – 3 Gang Anschnitt mit Rechtsspirale 35°

- For cutting whitworth pipe threads acc. to DIN ISO 228/1
- Form B = 4 – 5 threads lead with spiral point (gun nose)
- Form C 35° = 2 – 3 threads lead with spiral flute 35°

Ø d1		L 1 mm	L 2 mm	Ø d2 mm	mm		B		C 35°	
							Artikel-Nr. Part-No.	Artikel-Nr. Part-No.		
G 1/8" x 28	8,80	90	20	7,0	5,5	1	4175 03 00018	4176 03 00018		
G 1/4" x 19	11,80	100	22	11,0	9,0	1	4175 03 00014	4176 03 00014		
G 3/8" x 19	15,25	100	22	12,0	9,0	1	4175 03 00038	4176 03 00038		
G 1/2" x 14	19,00	125	25	16,0	12,0	1	4175 03 00012	4176 03 00012		
G 3/4" x 14	24,50	140	28	20,0	16,0	1	4175 03 00034	4176 03 00034		
G 1" x 11	30,75	160	30	25,0	20,0	1	4175 03 00100	4176 03 00100		

**MASCHINENGEWINDEBOHRER
MACHINE TAPS**

UNI Maschinengewindebohrer DIN 5156 HSS-E (Co5) · BSP
UNI machine taps DIN 5156 HSS-E (Co5) · BSP

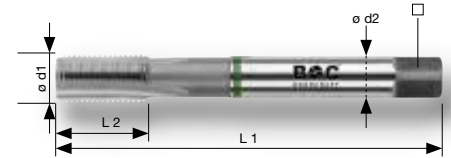

Code 4247



Code	P					M	K	N			
	1.1	2.1	3.1	4.1	5.1	1.1 - 4.1	2.1 - 2.2 / 4.1 - 4.2	1.1 - 1.3	1.4 - 1.6	2.1 - 2.5	4.2
4247	⊕	⊕	⊕	⊕	⊕		⊕	⊕	⊕	⊕	⊕

Für den universellen Einsatz in allgemeinen Baustählen, Automatenstahl, unlegierten Einsatzstählen und Aluminiumlegierungen (kurzspanend).

- Zum Schneiden von Whitworth Rohrgewinden DIN ISO 228/1
- Form C = 2 – 3 Gang Anschnitt
- Für Durchgangs- und Sackloch

For universal use in general structural steel, free-cutting steel, unalloyed case hardening steel and aluminium-alloys (short chipping).

- For cutting whitworth pipe threads acc. to ISO 228/1
- Form C = 2 – 3 threads lead
- For through- and blind hole

Ø d1		L 1 mm	L 2 mm	Ø d2 mm			Artikel-Nr. Part-No.
G 1/8" x 28	8,80	90	20	7	5,5	1	4247 03 00018
G 1/4" x 19	11,80	100	21	11	9,0	1	4247 03 00014
G 3/8" x 19	15,25	100	21	12	9,0	1	4247 03 00038
G 1/2" x 14	19,00	125	24	16	12,0	1	4247 03 00012
G 5/8" x 14	21,00	125	24	18	14,5	1	4247 03 00058
G 3/4" x 14	24,50	140	26	20	16,0	1	4247 03 00034
G 7/8" x 14	28,25	150	28	22	18,0	1	4247 03 00078
G 1" x 11	30,75	160	30	25	20,0	1	4247 03 00100



MASCHINENGEWINDEBOHRER
MACHINE TAPS

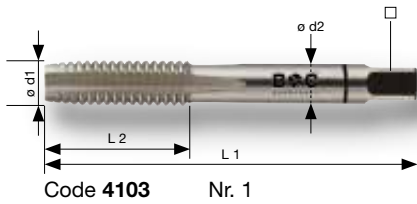

Nr. 2



Nr. 3



Für den allgemeinen Einsatz in gut zerspanbaren Werkstoffen mit einer Zugfestigkeit bis 800 N/mm².

- Zum Schneiden von Britisch-Standard-Whitworth-Gewinden nach BS 84 für Durchgangs- und Sackloch
- Nr. 1 Vorschneider 6 – 8 Gang Anschnitt
- Nr. 2 Mittelschneider 4 – 5 Gang Anschnitt
- Nr. 3 Fertigschneider 2 – 3 Gang Anschnitt

For general use in good machinable materials up to 800 N/mm² (22,5 HRC) tensile strength.

- For cutting british-standard-whitworth-threads acc. to BS 84 for through- and blind hole
- No. 1 Rougher 6 – 8 threads lead
- No. 2 Intermediate 4 – 5 threads lead
- No. 3 Finisher 2 – 3 threads lead

Ø d1		L 1 mm	L 2 mm	Ø d2 mm			Satz / Set	Nr. 1	Nr. 2	Nr. 3
BSW 1/8" x 40	2,60	40	12	3,5	2,7	1	4103 11 00018	4103 11 10018	4103 11 20018	4103 11 30018
BSW 5/32" x 32	3,10	45	14	4,5	3,4	1	4103 11 00532	4103 11 10532	4103 11 20532	4103 11 30532
BSW 3/16" x 24	3,60	50	18	6,0	4,9	1	4103 11 00316	4103 11 10316	4103 11 20316	4103 11 30316
BSW 1/4" x 20	5,10	50	19	6,0	4,9	1	4103 11 00014	4103 11 10014	4103 11 20014	4103 11 30014
BSW 5/16" x 18	6,50	56	22	6,0	4,9	1	4103 11 00516	4103 11 10516	4103 11 20516	4103 11 30516
BSW 3/8" x 16	7,90	70	24	7,0	5,5	1	4103 11 00038	4103 11 10038	4103 11 20038	4103 11 30038
BSW 7/16" x 14	9,30	70	24	8,0	6,2	1	4103 11 00716	4103 11 10716	4103 11 20716	4103 11 30716
BSW 1/2" x 12	10,50	75	29	9,0	7,0	1	4103 11 00012	4103 11 10012	4103 11 20012	4103 11 30012
BSW 9/16" x 12	12,00	80	30	11,0	9,0	1	4103 11 00916	4103 11 10916	4103 11 20916	4103 11 30916
BSW 5/8" x 11	13,50	80	32	12,0	9,0	1	4103 11 00058	4103 11 10058	4103 11 20058	4103 11 30058
BSW 3/4" x 10	16,50	95	40	14,0	11,0	1	4103 11 00034	4103 11 10034	4103 11 20034	4103 11 30034
BSW 7/8" x 9	19,25	100	40	18,0	14,5	1	4103 11 00078	4103 11 10078	4103 11 20078	4103 11 30078
BSW 1" x 8	22,00	110	50	18,0	14,5	1	4103 11 00100	4103 11 10100	4103 11 20100	4103 11 30100



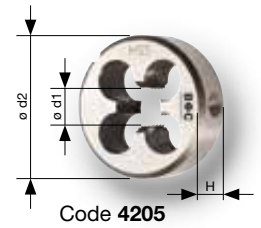

Für den allgemeinen Einsatz in gut zerspanbaren Werkstoffen mit einer Zugfestigkeit bis 800 N/mm².

- Zum Schneiden von Britisch-Standard-Whitworth-Gewinden nach BS 84
- Form B = geschlossen, vorgeschlitzt

For general use in good machinable materials up to 800 N/mm² (22,5 HRC) tensile strength.

- For cutting british-standard-whitworth-threads acc. to BS 84
- Form B = preslotted, closed

Ø d1	Bolzen / Bolt mm	Ø d2 mm	H mm		Artikel-Nr. Part-No.
BSW 1/8" x 40	3,09	20	5	1	4205 11 00018
BSW 5/32" x 32	3,88	20	5	1	4205 11 00532
BSW 3/16" x 24	4,46	20	7	1	4205 11 00316
BSW 1/4" x 20	6,17	20	7	1	4205 11 00014
BSW 5/16" x 18	7,76	25	9	1	4205 11 00516
BSW 3/8" x 16	9,30	30	11	1	4205 11 00038
BSW 7/16" x 14	10,90	30	11	1	4205 11 00716
BSW 1/2" x 12	12,44	38	14	1	4205 11 00012
BSW 9/16" x 12	14,02	38	14	1	4205 11 00916
BSW 5/8" x 11	15,62	45	18	1	4205 11 00058
BSW 3/4" x 10	18,76	45	18	1	4205 11 00034
BSW 7/8" x 9	21,90	55	22	1	4205 11 00078
BSW 1" x 8	25,08	55	22	1	4205 11 00100



BSW

SCHNEIDEISEN
DIES

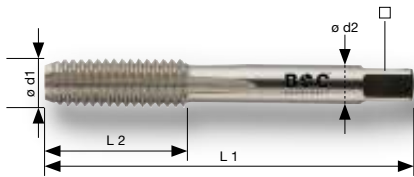

Code 4133



Code	P					M	K	N			
	1.1	2.1	3.1	4.1	5.1	1.1 - 4.1	2.1 - 2.2 / 4.1 - 4.2	1.1 - 1.3	1.4 - 1.6	2.1 - 2.5	4.2
4133	☉	☉					☉	☉			☉

- Zum Schneiden von British-Standard-Whitworth-Gewinden nach BS 84
- Für Hand- und Maschinengebrauch
- 2 – 3 Gang Anschnitt für Durchgangs- und Sackloch

- For cutting british-standard-whitworth-threads acc. to BS 84
- For manual and machine use
- 2 – 3 threads lead for through- and blind hole

Ø d1		L 1 mm	L 2 mm	Ø d2 mm			Artikel-Nr. Part-No.
BSW 1/8" x 40	2,60	40	12	3,5	2,7	1	4133 03 00018
BSW 3/16" x 24	3,60	50	18	6,0	4,9	1	4133 03 00316
BSW 1/4" x 20	5,10	50	19	6,0	4,9	1	4133 03 00014
BSW 5/16" x 18	6,50	56	22	6,0	4,9	1	4133 03 00516
BSW 3/8" x 16	7,90	70	24	7,0	5,5	1	4133 03 00038
BSW 7/16" x 14	9,30	70	24	8,0	6,2	1	4133 03 00716
BSW 1/2" x 12	10,50	75	29	9,0	7,0	1	4133 03 00012
BSW 9/16" x 12	12,00	80	30	11,0	9,0	1	4133 03 00916
BSW 5/8" x 11	13,50	80	32	12,0	9,0	1	4133 03 00058
BSW 3/4" x 10	16,50	95	40	14,0	11,0	1	4133 03 00034
BSW 7/8" x 9	19,25	100	40	18,0	14,5	1	4133 03 00078
BSW 1" x 8	22,00	110	50	18,0	14,5	1	4133 03 00100



BSW

EINSCHNITTGEWINDEBOHRER
SHORT MACHINE TAPS

Handgewindebohrer ähnl. DIN 352 HSS-G | UNC

Hand taps similar DIN 352 HSS-G | UNC



Nr. 2



Nr. 3



Für den allgemeinen Einsatz in gut zerspanbaren Werkstoffen mit einer Zugfestigkeit bis 800 N/mm².

- Zum Schneiden von amerikanischen Grobgewinden nach ANSI B1. 1 für Durchgangs- und Sackloch
- Nr. 1 Vorschneider 6 – 8 Gang Anschnitt
- Nr. 2 Mittelschneider 4 – 5 Gang Anschnitt
- Nr. 3 Fertigschneider 2 – 3 Gang Anschnitt

For general use in good machinable materials up to 800 N/mm² (22,5 HRC) tensile strength.

- For cutting american unified national coarse thread acc. to ANSI B1. 1 for through- and blind hole
- No. 1 Rougher 6 – 8 threads lead
- No. 2 Intermediate 4 – 5 threads lead
- No. 3 Finisher 2 – 3 threads lead

Ø d1		L 1 mm	L 2 mm	Ø d2 mm			Satz / Set	Nr. 1	Nr. 2	Nr. 3
UNC Nr. 2 x 56	1,80	36	11	2,8	2,1	1	4104 11 00256	4104 11 10256	4104 11 20256	4104 11 30256
UNC Nr. 3 x 48	2,10	36	11	2,8	2,1	1	4104 11 00348	4104 11 10348	4104 11 20348	4104 11 30348
UNC Nr. 4 x 40	2,30	40	12	3,5	2,7	1	4104 11 00440	4104 11 10440	4104 11 20440	4104 11 30440
UNC Nr. 5 x 40	2,60	40	12	3,5	2,7	1	4104 11 00540	4104 11 10540	4104 11 20540	4104 11 30540
UNC Nr. 6 x 32	2,85	45	14	4,0	3,0	1	4104 11 00632	4104 11 10632	4104 11 20632	4104 11 30632
UNC Nr. 8 x 32	3,50	45	14	4,5	3,4	1	4104 11 00832	4104 11 10832	4104 11 20832	4104 11 30832
UNC Nr. 10 x 24	3,90	50	16	6,0	4,9	1	4104 11 01024	4104 11 11024	4104 11 21024	4104 11 31024
UNC Nr. 12 x 24	4,50	50	18	6,0	4,9	1	4104 11 01224	4104 11 11224	4104 11 21224	4104 11 31224
UNC 1/4" x 20	5,20	56	22	6,0	4,9	1	4104 11 00014	4104 11 10014	4104 11 20014	4104 11 30014
UNC 5/16" x 18	6,60	63	25	6,0	4,9	1	4104 11 00516	4104 11 10516	4104 11 20516	4104 11 30516
UNC 3/8" x 16	8,00	70	28	7,0	5,5	1	4104 11 00038	4104 11 10038	4104 11 20038	4104 11 30038
UNC 7/16" x 14	9,40	75	30	8,0	6,2	1	4104 11 00716	4104 11 10716	4104 11 20716	4104 11 30716
UNC 1/2" x 13	10,80	80	32	9,0	7,0	1	4104 11 00012	4104 11 10012	4104 11 20012	4104 11 30012
UNC 9/16" x 12	12,20	80	32	11,0	9,0	1	4104 11 00916	4104 11 10916	4104 11 20916	4104 11 30916
UNC 5/8" x 11	13,50	90	36	12,0	9,0	1	4104 11 00058	4104 11 10058	4104 11 20058	4104 11 30058
UNC 3/4" x 10	16,50	105	40	14,0	11,0	1	4104 11 00034	4104 11 10034	4104 11 20034	4104 11 30034
UNC 7/8" x 9	19,50	110	45	18,0	14,5	1	4104 11 00078	4104 11 10078	4104 11 20078	4104 11 30078
UNC 1" x 8	22,25	110	50	18,0	14,5	1	4104 11 00100	4104 11 10100	4104 11 20100	4104 11 30100
UNC 1.1/8" x 7	25,00	132	56	22,0	18,0	1	4104 11 00118	4104 11 10118	4104 11 20118	4104 11 30118
UNC 1.1/4" x 7	28,25	132	56	22,0	18,0	1	4104 11 00114	4104 11 10114	4104 11 20114	4104 11 30114
UNC 1.1/2" x 6	34,00	150	63	32,0	24,0	1	4104 11 00112	4104 11 10112	4104 11 20112	4104 11 30112
UNC 2" x 4.1/2	45,00	190	80	40,0	32,0	1	4104 11 00200	4104 11 10200	4104 11 20200	4104 11 30200

BC Holzkassette / BC Wooden-Box

Bezeichnung Description	Teile Pieces	Inhalt Content	Artikel-Nr. Part-No.
GWH UNC	44 UNC 1/4" – 1"	HGB-Sätze 3-tlg. / Hand-tap sets 3 pcs. ~ DIN 352 + Schneideisen / Circular dies DIN EN 22568 UNC 1/4" · UNC 5/16" · UNC 3/8" · UNC 7/16" · UNC 1/2" · UNC 5/8" · UNC 3/4" · UNC 7/8" · UNC 1" Halter / Holders DIN 225 20 x 7 · 25 x 9 · 30 x 11 · 38 x 14 · 45 x 18 · 55 x 22 Windeisen / Tap wrenches DIN 1814, Gr. 1 + 4	6000 14 50044



GWH UNC

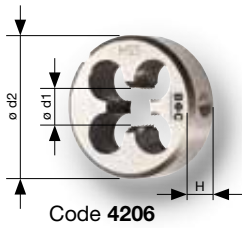

Für den allgemeinen Einsatz in gut zerspanbaren Werkstoffen mit einer Zugfestigkeit bis 800 N/mm².

- Zum Schneiden von amerikanischen Grobgewinden nach ANSI B1. 1
- Form B = geschlossen, vorgeschlitzt

For general use in good machinable materials up to 800 N/mm² (22,5 HRC) tensile strength.

- For cutting american unified national coarse thread acc. to ANSI B1. 1
- Form B = preslotted, closed

Ø d1	Bolzen / Bolt mm	Ø d2 mm	H mm		Artikel-Nr. Part-No.
UNC Nr. 2 x 56	2,12	16	5	1	4206 11 00256
UNC Nr. 3 x 48	2,44	16	5	1	4206 11 00348
UNC Nr. 4 x 40	2,76	20	5	1	4206 11 00440
UNC Nr. 5 x 40	3,09	20	5	1	4206 11 00540
UNC Nr. 6 x 32	3,41	20	7	1	4206 11 00632
UNC Nr. 8 x 32	4,07	20	7	1	4206 11 00832
UNC Nr. 10 x 24	4,71	20	7	1	4206 11 01024
UNC Nr. 12 x 24	5,37	20	7	1	4206 11 01224
UNC 1/4" x 20	6,22	20	7	1	4206 11 00014
UNC 5/16" x 18	7,80	25	9	1	4206 11 00516
UNC 3/8" x 16	9,37	30	11	1	4206 11 00038
UNC 7/16" x 14	10,95	30	11	1	4206 11 00716
UNC 1/2" x 13	12,52	38	14	1	4206 11 00012
UNC 9/16" x 12	14,10	38	14	1	4206 11 00916
UNC 5/8" x 11	15,68	45	18	1	4206 11 00058
UNC 3/4" x 10	18,84	45	18	1	4206 11 00034
UNC 7/8" x 9	22,00	55	22	1	4206 11 00078
UNC 1" x 8	25,16	55	22	1	4206 11 00100
UNC 1.1/8" x 7	28,31	65	25	1	4206 11 00118
UNC 1.1/4" x 7	31,49	65	25	1	4206 11 00114
UNC 1.1/2" x 6	37,80	65	25	1	4206 11 00112
UNC 2" x 4.1/2	50,45	90	36	1	4206 11 00200



UNC

SCHNEIDEISEN
DIES

Einschnittgewindebohrer ähnl. DIN 352 HSS-G | UNC
Short machine taps similar DIN 352 HSS-G

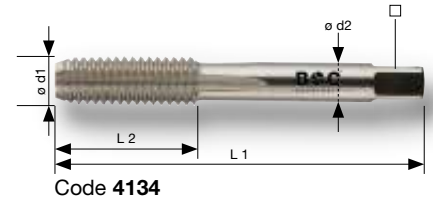

Code	P					M	K	N			
	1.1	2.1	3.1	4.1	5.1	1.1 - 4.1	2.1 - 2.2 / 4.1 - 4.2	1.1 - 1.3	1.4 - 1.6	2.1 - 2.5	4.2
4134	⊕	⊕					⊕	⊕			⊕

- Zum Schneiden von amerikanischen Grobgewinden nach ANSI B1. 1
- Für Hand- und Maschinengebrauch
- 2 – 3 Gang Anschnitt für Durchgangs- und Sackloch
- For cutting american unified national coarse thread acc. to ANSI B1. 1
- For manual and machine use
- 2 – 3 threads lead for through- and blind hole

Ø d1		L 1 mm	L 2 mm	Ø d2 mm			Artikel-Nr. Part-No.
UNC 1/4" x 20	5,20	56	22	6,0	4,9	1	4134 03 00014
UNC 5/16" x 18	6,60	63	25	7,0	4,9	1	4134 03 00516
UNC 3/8" x 16	8,00	70	28	7,0	5,5	1	4134 03 00038
UNC 7/16" x 14	9,40	75	30	8,0	6,2	1	4134 03 00716
UNC 1/2" x 13	10,80	80	32	9,0	7,0	1	4134 03 00012
UNC 9/16" x 12	12,20	80	32	11,0	9,0	1	4134 03 00916
UNC 5/8" x 11	13,50	90	36	12,0	9,0	1	4134 03 00058
UNC 3/4" x 10	16,50	105	40	14,0	11,0	1	4134 03 00034
UNC 7/8" x 9	19,50	110	45	18,0	14,5	1	4134 03 00078
UNC 1" x 8	22,25	110	50	18,0	14,5	1	4134 03 00100
UNC 1.1/8" x 7	25,00	132	56	22,0	18,0	1	4134 03 00118
UNC 1.1/4" x 7	28,25	132	56	22,0	18,0	1	4134 03 00114
UNC 1.1/2" x 6	34,00	150	63	32,0	24,0	1	4134 03 00112
UNC 2" x 4.1/2	45,00	190	80	40,0	32,0	1	4134 03 00200



EINSCHNITTGEWINDEBOHRER
SHORT MACHINE TAPS



Code **4196** / ~DIN 371



Code **4197** / ~DIN 371



Code	P					M	K	N			
	1.1	2.1	3.1	4.1	5.1	1.1 - 4.1	2.1 - 2.2 / 4.1 - 4.2	1.1 - 1.3	1.4 - 1.6	2.1 - 2.5	4.2
4196 · 4197	⊕	⊕	⊕				⊕	⊕	⊕	⊕	⊕

- Zum Schneiden von amerikanischen Grobgewinden nach ANSI B1. 1
- Form B = 4 – 5 Gang Anschnitt mit Schälanschnitt
- Form C 35° = 2 – 3 Gang Anschnitt mit Rechtsspirale 35°
- For cutting american unified national coarse thread acc. to ANSI B1. 1
- Form B = 4 – 5 threads lead with spiral point (gun nose)
- Form C 35° = 2 – 3 threads lead with spiral flute 35°

Ø d1	Hand	L 1 mm	L 2 mm		Ø d2 mm	mm	Flute	B		C 35°	
			B	C 35°				Artikel-Nr. Part-No.	Artikel-Nr. Part-No.		
~DIN 371											
UNC 1/4" x 20	5,20	80	17	13	7,0	5,5	1	4196 03 00014	4197 03 00014		
UNC 5/16" x 18	6,60	90	20	14	8,0	6,2	1	4196 03 00516	4197 03 00516		
UNC 3/8" x 16	8,00	100	22	16	9,0	7,0	1	4196 03 00038	4197 03 00038		
~DIN 376											
UNC 7/16" x 14	9,40	100	22	17	8,0	6,2	1	4196 03 00716	4197 03 00716		
UNC 1/2" x 13	10,80	110	25	20	9,0	7,0	1	4196 03 00012	4197 03 00012		
UNC 9/16" x 12	12,20	110	26	20	11,0	9,0	1	4196 03 00916	4197 03 00916		
UNC 5/8" x 11	13,50	110	27	22	12,0	9,0	1	4196 03 00058	4197 03 00058		
UNC 3/4" x 10	16,50	125	30	25	14,0	11,0	1	4196 03 00034	4197 03 00034		
UNC 7/8" x 9	19,50	140	32	27	18,0	14,5	1	4196 03 00078	4197 03 00078		
UNC 1" x 8	22,25	160	36	30	20,0	16,0	1	4196 03 00100	4197 03 00100		





Handgewindebohrer ähnl. DIN 2181 HSS-G

Hand taps similar DIN 2181 HSS-G

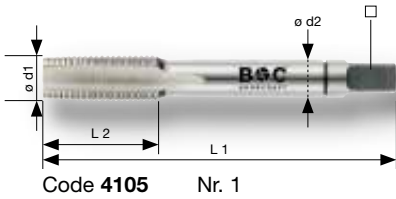

Nr. 2



Für den allgemeinen Einsatz in gut zerspanbaren Werkstoffen mit einer Zugfestigkeit bis 800 N/mm².

- Zum Schneiden von amerikanischen Feingewinden nach ANSI B1. 1 für Durchgangs- und Sackloch
- Nr. 1 Vorschneider 5 – 6 Gang Anschnitt
- Nr. 2 Fertigschneider 2 – 3 Gang Anschnitt

For general use in good machinable materials up to 800 N/mm² (22,5 HRC) tensile strength.

- For cutting american unified national fine thread acc. to ANSI B1. 1 for through- and blind hole
- No. 1 Rougher 5 – 6 threads lead
- No. 2 Finisher 2 – 3 threads lead

Ø d1		L 1 mm	L 2 mm	Ø d2 mm			Satz / Set	Nr. 1	Nr. 2
UNF Nr. 2 x 64	1,90	32	10	2,8	2,1	1	4105 11 00264	4105 11 10264	4105 11 20264
UNF Nr. 3 x 56	2,10	32	10	2,8	2,1	1	4105 11 00356	4105 11 10356	4105 11 20356
UNF Nr. 4 x 48	2,40	36	11	3,5	2,7	1	4105 11 00448	4105 11 10448	4105 11 20448
UNF Nr. 5 x 44	2,70	36	11	3,5	2,7	1	4105 11 00544	4105 11 10544	4105 11 20544
UNF Nr. 6 x 40	3,00	40	12	4,5	3,4	1	4105 11 00640	4105 11 10640	4105 11 20640
UNF Nr. 8 x 36	3,50	40	12	4,5	3,4	1	4105 11 00836	4105 11 10836	4105 11 20836
UNF Nr. 10 x 32	4,10	45	14	6,0	4,9	1	4105 11 01032	4105 11 11032	4105 11 21032
UNF Nr. 12 x 28	4,70	50	14	6,0	4,9	1	4105 11 01228	4105 11 11228	4105 11 21228
UNF 1/4" x 28	5,50	56	18	6,0	4,9	1	4105 11 00014	4105 11 10014	4105 11 20014
UNF 5/16" x 24	6,90	56	18	6,0	4,9	1	4105 11 00516	4105 11 10516	4105 11 20516
UNF 3/8" x 24	8,50	63	18	7,0	5,5	1	4105 11 00038	4105 11 10038	4105 11 20038
UNF 7/16" x 20	9,90	63	18	8,0	6,2	1	4105 11 00716	4105 11 10716	4105 11 20716
UNF 1/2" x 20	11,50	63	20	9,0	7,0	1	4105 11 00012	4105 11 10012	4105 11 20012
UNF 9/16" x 18	12,90	70	20	11,0	9,0	1	4105 11 00916	4105 11 10916	4105 11 20916
UNF 5/8" x 18	14,50	70	20	12,0	9,0	1	4105 11 00058	4105 11 10058	4105 11 20058
UNF 3/4" x 16	17,50	80	22	14,0	11,4	1	4105 11 00034	4105 11 10034	4105 11 20034
UNF 7/8" x 14	20,25	80	22	18,0	14,5	1	4105 11 00078	4105 11 10078	4105 11 20078
UNF 1" x 12	23,25	90	22	18,0	14,5	1	4105 11 00100	4105 11 10100	4105 11 20100

BC Holzkassette / BC Wooden-Box

Bezeichnung Description	Teile Pieces	Inhalt Content	Artikel-Nr. Part-No.
GWH UNF	35 UNF 1/4" – 1"	HGB-Sätze 2-tlg. / Hand-tap sets 2 pcs. ~ DIN 2181 + Schneideisen / Circular dies DIN EN 22568 UNF 1/4" · UNF 5/16" · UNF 3/8" · UNF 7/16" · UNF 1/2" · UNF 5/8" · UNF 3/4" · UNF 7/8" · UNF 1" Halter / Holders DIN 225 20 x 7 · 25 x 9 · 30 x 11 · 38 x 10 · 45 x 14 · 55 x 16 Windeisen / Tap wrenches DIN 1814, Gr. 1 + 4	6000 14 50035



GWH UNF

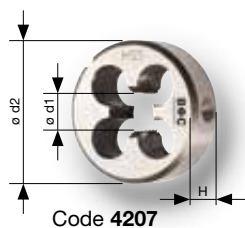

Für den allgemeinen Einsatz in gut zerspanbaren Werkstoffen mit einer Zugfestigkeit bis 800 N/mm².

- Zum Schneiden von amerikanischen Feingewinden nach ANSI B1. 1
- Form B = geschlossen, vorgeschlitzt

For general use in good machinable materials up to 800 N/mm² (22,5 HRC) tensile strength.

- For cutting american unified national fine thread acc. to ANSI B1. 1
- Form B = preslotted, closed

Ø d1	Bolzen / Bolt mm	Ø d2 mm	H mm		Artikel-Nr. Part-No.
UNF Nr. 2 x 64	2,12	16	5	1	4207 11 00264
UNF Nr. 3 x 56	2,44	16	5	1	4207 11 00356
UNF Nr. 4 x 48	2,77	20	5	1	4207 11 00448
UNF Nr. 5 x 44	3,10	20	5	1	4207 11 00544
UNF Nr. 6 x 40	3,42	20	5	1	4207 11 00640
UNF Nr. 8 x 36	4,08	20	7	1	4207 11 00836
UNF Nr. 10 x 32	4,73	20	7	1	4207 11 01032
UNF Nr. 12 x 28	5,38	20	7	1	4207 11 01228
UNF 1/4" x 28	6,24	20	7	1	4207 11 00014
UNF 5/16" x 24	7,82	25	9	1	4207 11 00516
UNF 3/8" x 24	9,41	30	11	1	4207 11 00038
UNF 7/16" x 20	10,98	30	11	1	4207 11 00716
UNF 1/2" x 20	12,56	38	10	1	4207 11 00012
UNF 9/16" x 18	14,14	38	10	1	4207 11 00916
UNF 5/8" x 18	15,73	45	14	1	4207 11 00058
UNF 3/4" x 16	18,89	45	14	1	4207 11 00034
UNF 7/8" x 14	22,05	55	16	1	4207 11 00078
UNF 1" x 12	25,21	55	16	1	4207 11 00100



UNF

SCHNEIDEISEN
DIES

Einschnittgewindebohrer ähnl. DIN 2181 HSS-G | UNF
Short machine taps similar DIN 2181 HSS-G

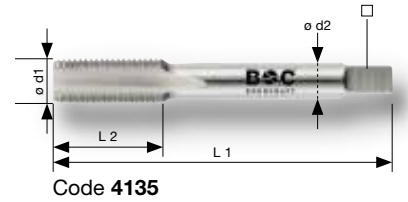

Code 4135



Code	P					M	K	N			
	1.1	2.1	3.1	4.1	5.1	1.1 - 4.1	2.1 - 2.2 / 4.1 - 4.2	1.1 - 1.3	1.4 - 1.6	2.1 - 2.5	4.2
4135	⊕	⊕					⊕	⊕			⊕

- Zum Schneiden von amerikanischen Feingewinden nach ANSI B1. 1
- Für Hand- und Maschinengebrauch
- 2 – 3 Gang Anschnitt für Durchgangs- und Sackloch
- For cutting american unified national fine thread acc. to ANSI B1. 1
- For manual and machine use
- 2 – 3 threads lead for through- and blind hole

Ø d1		L 1 mm	L 2 mm	Ø d2 mm	□ mm		Artikel-Nr. Part-No.
UNF 1/4" x 28	5,50	50	18	6,0	4,9	1	4135 03 00014
UNF 5/16" x 24	6,90	56	22	6,0	4,9	1	4135 03 00516
UNF 3/8" x 24	8,50	63	22	7,0	5,5	1	4135 03 00038
UNF 7/16" x 20	9,90	63	22	8,0	6,2	1	4135 03 00716
UNF 1/2" x 20	11,50	75	24	9,0	7,0	1	4135 03 00012
UNF 9/16" x 18	12,90	80	28	11,0	9,0	1	4135 03 00916
UNF 5/8" x 18	14,50	80	28	12,0	9,0	1	4135 03 00058
UNF 3/4" x 16	17,50	95	32	14,0	11,0	1	4135 03 00034
UNF 7/8" x 14	20,25	100	36	18,0	14,5	1	4135 03 00078
UNF 1" x 12	23,25	110	40	18,0	14,5	1	4135 03 00100



UNF

EINSCHNITTGEWINDEBOHRER
SHORT MACHINE TAPS

UNF Maschinengewindebohrer ähnl. DIN 371 / 376 HSS-E (Co5)

Machine taps similar DIN 371 / 376 HSS-E (Co5)



Code **4198** / ~DIN 371



Code **4199** / ~DIN 371



Code	P					M	K	N			
	1.1	2.1	3.1	4.1	5.1	1.1 - 4.1	2.1 - 2.2 / 4.1 - 4.2	1.1 - 1.3	1.4 - 1.6	2.1 - 2.5	4.2
4198 · 4199	⊕	⊕	⊕				⊕	⊕	⊕	⊕	⊕

- Zum Schneiden von amerikanischen Feingewinden nach ANSI B1. 1
- Form B = 4 – 5 Gang Anschnitt mit Schälanschnitt
- Form C 35° = 2 – 3 Gang Anschnitt mit Rechtsspirale 35°

- For cutting american unified national fine thread acc. to ANSI B1. 1
- Form B = 4 – 5 threads lead with spiral point (gun nose)
- Form C 35° = 2 – 3 threads lead with spiral flute 35°

Ø d1	Icon	L 1 mm	L 2 mm		Ø d2 mm	□ mm	Icon	B	C 35°
			B	C 35°				Artikel-Nr. Part-No.	Artikel-Nr. Part-No.
~DIN 371									
UNF 1/4" x 28	5,50	80	17	10	7,0	5,5	1	4198 03 00014	4199 03 00014
UNF 5/16" x 24	6,90	90	17	10	8,0	6,2	1	4198 03 00516	4199 03 00516
UNF 3/8" x 24	8,50	100	18	10	9,0	7,0	1	4198 03 00038	4199 03 00038
~DIN 376									
UNF 7/16" x 20	9,90	100	22	13	8,0	6,2	1	4198 03 00716	4199 03 00716
UNF 1/2" x 20	11,50	100	22	13	9,0	7,0	1	4198 03 00012	4199 03 00012
UNF 9/16" x 18	12,90	100	22	15	11,0	9,0	1	4198 03 00916	4199 03 00916
UNF 5/8" x 18	14,50	100	22	15	12,0	9,0	1	4198 03 00058	4199 03 00058
UNF 3/4" x 16	17,50	110	25	17	14,0	11,0	1	4198 03 00034	4199 03 00034
UNF 7/8" x 14	20,25	140	26	17	18,0	14,5	1	4198 03 00078	4199 03 00078
UNF 1" x 12	23,25	150	28	20	20,0	16,0	1	4198 03 00100	4199 03 00100



UNF

MASCHINENGEWINDEBOHRER
MACHINE TAPS



Einschnittgewindebohrer HSS-G | NPT

Short machine taps HSS-G

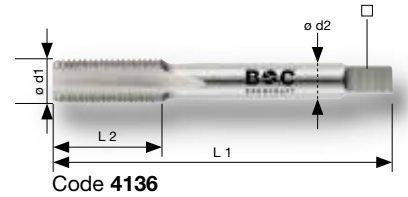

Code 4136



Code	P					M	K	N			
	1.1	2.1	3.1	4.1	5.1	1.1 - 4.1	2.1 - 2.2 / 4.1 - 4.2	1.1 - 1.3	1.4 - 1.6	2.1 - 2.5	4.2
4136	☉	☉					☉	☉			☉

- Zum Schneiden von amerikanischem kegeligem Rohrge-
winde, Kegel 1:16
- Für Gewinde mit Dichtmittel
- Für Hand- und Maschinengebrauch
- 2 – 3 Gang Anschnitt für Durchgangs- und Sackloch
- For cutting american standard pipe thread, taper 1:16
- For threads with sealing material
- For manual and machine use
- 2 – 3 threads lead for through- and blind hole

Ø d1		L 1 mm	L 2 mm	Ø d2 mm			Artikel-Nr. Part-No.
NPT 1/16" x 27	6,25	54	17,5	7,9	6,0	1	4136 03 00116
NPT 1/8" x 27	8,50	54	19,0	8,0	8,3	1	4136 03 00018
NPT 1/4" x 18	11,10	62	27,0	14,3	11,0	1	4136 03 00014
NPT 3/8" x 18	14,70	65	27,0	17,8	13,5	1	4136 03 00038
NPT 1/2" x 14	18,00	79	35,0	17,4	13,0	1	4136 03 00012
NPT 3/4" x 14	23,25	82	35,0	23,0	17,0	1	4136 03 00034
NPT 1" x 11,5	29,25	95	44,5	28,6	21,0	1	4136 03 00100
NPT 1.1/4" x 11,5	38,00	102	44,5	33,3	25,0	1	4136 03 00114
NPT 1.1/2" x 11,5	44,25	108	44,5	36,0	28,0	1	4136 03 00112
NPT 2" x 11,5	56,25	114	44,5	47,6	35,0	1	4136 03 00200



NPT

EINSCHNITTGEWINDEBOHRER
SHORT MACHINE TAPS

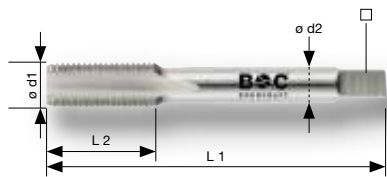

Code 4130



Code	P					M	K	N			
	1.1	2.1	3.1	4.1	5.1	1.1 - 4.1	2.1 - 2.2 / 4.1 - 4.2	1.1 - 1.3	1.4 - 1.6	2.1 - 2.5	4.2
4130	☉	☉					☉	☉			☉

- Zum Schneiden von Stahlpanzerrohr-Gewinden nach DIN 40430
- Für Hand- und Maschinengebrauch
- 2 – 3 Gang Anschnitt für Durchgangs- und Sackloch

- For cutting steel conduit thread acc. to DIN 40430
- For manual and machine use
- 2 – 3 threads lead for through- and blind hole

Ø d1		L 1 mm	L 2 mm	Ø d2 mm			Artikel-Nr. Part-No.
PG 7 x 20		11,35	70	9,0	7,0	1	4130 03 00700
PG 9 x 18		13,95	70	12,0	9,0	1	4130 03 00900
PG 11 x 18		17,35	80	14,0	11,0	1	4130 03 01100
PG 13,5 x 18		19,15	80	16,0	12,0	1	4130 03 01350
PG 16 x 18		21,25	80	18,0	14,5	1	4130 03 01600
PG 21 x 16		26,75	90	22,0	18,0	1	4130 03 02100
PG 29 x 16		35,50	100	28,0	22,0	1	4130 03 02900
PG 36 x 16		45,50	140	36,0	29,0	1	4130 03 03600
PG 42 x 16		52,50	140	40,0	32,0	1	4130 03 04200
PG 48 x 16		58,00	160	45,0	35,0	1	4130 03 04800



PG

EINSCHNITTGEWINDEBOHRER
SHORT MACHINE TAPS



Code 9651



Zum Messen von Innen- und Außengewinden.

For measuring internal and external threads.

Gewinde Thread		Bereich Range	Steigung Pitch			Artikel-Nr. Part-No.
M	60°	0,4 – 6,0	0,4 · 0,45 · 0,5 · 0,6 · 0,7 · 0,75 · 0,8 · 1,0 · 1,25 · 1,5 · 1,75 · 2,0 · 2,5 · 3,0 · 3,5 · 4,0 · 4,5 · 5,0 · 5,5 · 6,0	20	1	9651 15 00020
M	60°	0,25 – 6,0	0,25 · 0,3 · 0,35 · 0,4 · 0,45 · 0,5 · 0,6 · 0,7 · 0,75 · 0,8 · 0,9 · 1,0 · 1,25 · 1,5 · 1,75 · 2,0 · 2,5 · 3,0 · 3,5 · 4,0 · 4,5 · 5,0 · 5,5 · 6,0	52	1	9651 15 00052
WW	55°	4 – 62	4 · 4,5 · 5 · 6 · 7 · 8 · 9 · 10 · 11 · 12 · 13 · 14 · 16 · 18 · 19 · 20 · 22 · 24 · 25 · 26 · 28 · 30 · 32 · 36 · 40 · 48 · 60 · 62	28	1	9651 15 00028
WW	55°	4 – 62	4 · 4,5 · 5 · 6 · 7 · 8 · 9 · 10 · 11 · 12 · 13 · 14 · 16 · 18 · 19 · 20 · 22 · 24 · 25 · 26 · 28 · 30 · 32 · 36 · 40 · 48 · 60 · 62	6	1	9651 15 00006
WW G/BSP	55°	8 – 28	8 · 10 · 11 · 14 · 19 · 28	22	1	9651 15 00022
UNC	60°	4 – 64	4 · 4,5 · 5 · 6 · 7 · 8 · 9 · 10 · 11 · 12 · 13 · 14 · 16 · 18 · 20 · 24 · 28 · 32 · 40 · 48 · 56 · 64	16	1	9651 15 00016
UNF	60°	12 – 80	12 · 14 · 16 · 18 · 20 · 24 · 28 · 32 · 36 · 40 · 44 · 48 · 56 · 64 · 72 · 80			

Gewindefeilen Thread restoring files



Code 4501

Zum Nacharbeiten und Reparieren beschädigter Innen- und Außengewinde.

For reworking and repairing damaged internal and external threads.

Gewinde Thread		Steigung Pitch	L 1		Artikel-Nr. Part-No.
M	60°	0,8 · 1,0 · 1,25 · 1,5 · 1,75 · 2,0 · 2,5 · 3,0	230	1	4501 03 00001
WW	55°	10 · 11 · 12 · 14 · 16 · 18 · 20 · 24	230	1	4501 03 00002
UNC/UNF	60°	11 · 12 · 13 · 14 · 16 · 18 · 20 · 24	230	1	4501 03 00003

GEWINDESCHABLONEN · GEWINDEFEILEN
THREAD GAUGES · THREAD RESTORING FILES

Verstellbare Windeisen DIN 1814

Adjustable tap wrenches DIN 1814

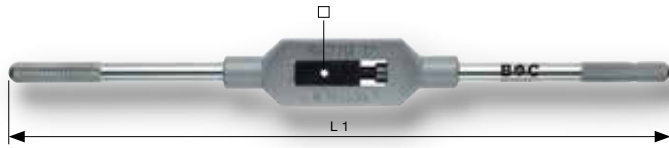

Code 4300

DIN
1814

- Gehäuse aus Zinkdruckguss
- Gehärtete Spannbacken
- Zum Spannen von Vierkantschäften
- Ein Griff abschraubbar

- Housing made of zinc die casting
- Hardened chuck jaws
- For tools with square shanks
- One handle can be unscrewed

Größe Size	M - MF	G	□ mm	L 1 mm		Artikel-Nr. Part-No.		Artikel-Nr. Part-No.
0	M 1 - 8	-	2,1 - 4,9	130	1	4300 15 00000	1	4300 07 00000
1	M 1 - 10	-	2,4 - 5,5	180	1	4300 15 00010	1	4300 07 00010
1.1/2	M 1 - 12	1/8"	2,4 - 7,0	180	1	4300 15 00015	1	4300 07 00015
2	M 4 - 12	1/8" - 3/8"	3,4 - 8,0	280	1	4300 15 00020	-	-
3	M 5 - 20	1/8" - 1/2"	4,9 - 12,0	380	1	4300 15 00030	-	-
4	M 11 - 27	1/8" - 3/4"	5,5 - 16,0	500	1	4300 15 00040	-	-
5	M 13 - 32	1/4" - 1"	9,0 - 20,0	700	1	4300 15 00050	-	-
6	M 18 - 42	1/2" - 1.1/4"	12,0 - 24,0	1000	1	4300 15 00060	-	-
7	M 27 - 52	3/4" - 1.3/4"	16,0 - 32,0	1250	1	4300 15 00070	-	-

Schneideisenhalter DIN 225

Die stocks DIN 225

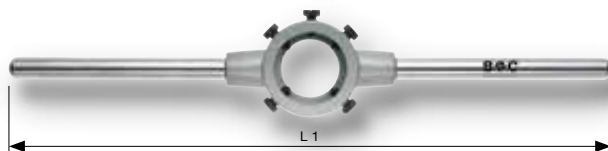

Code 4400

DIN
225

- Gehäuse aus Zinkdruckguss
- Zur Aufnahme von Schneideisen

- Housing made of zinc die casting
- For direct holding of circular dies

Größe Size	Maße / Measure mm	M - MF	G	L 1 mm		Artikel-Nr. Part-No.		Artikel-Nr. Part-No.
0	16 x 5	M 1 - 2,6	-	160	1	4400 15 01605	-	-
1	20 x 5	M 3 - 4	-	200	1	4400 15 02005	1	4400 07 02005
2	20 x 7	M 4,5 - 6	-	200	1	4400 15 02007	1	4400 07 02007
3	25 x 9	M 7 - 9	-	224	1	4400 15 02509	1	4400 07 02509
4	30 x 11	M 10 - 11	1/8"	280	1	4400 15 03011	1	4400 07 03011
5	38 x 10	MF 12 - 14	1/4"	315	1	4400 15 03810	-	-
5b	38 x 14	M 12 - 14	-	315	1	4400 15 03814	1	4400 07 03814
6	45 x 14	MF 16 - 20	3/8" - 1/2"	450	1	4400 15 04514	-	-
6b	45 x 18	M 16 - 20	-	450	1	4400 15 04518	-	-
7	55 x 16	MF 22 - 24	5/8" - 3/4"	560	1	4400 15 05516	-	-
7b	55 x 22	M 22 - 24	-	560	1	4400 15 05522	-	-
8	65 x 18	MF 27 - 36	7/8" - 1"	630	1	4400 15 06518	-	-
8b	65 x 25	M 27 - 36	-	630	1	4400 15 06525	-	-
9	75 x 20	MF 38 - 42	1.1/8" - 1.1/4"	800	1	4400 15 07520	-	-
9b	75 x 30	M 39 - 42	-	800	1	4400 15 07530	-	-
10b	90 x 36	M 45 - 52	-	900	1	4400 15 09036	-	-

Werkzeughalter mit Knarre Tap wrenches with ratchet

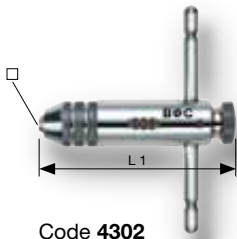

Code **4302** Kurze Ausführung / short version

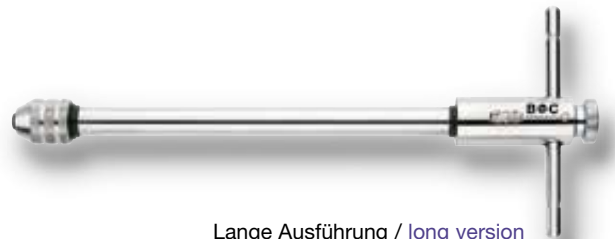

Lange Ausführung / long version

- Links- und Rechtslauf einstellbar
- Quergriff verschiebbar
- Mit Zweibackenn Spannfutter zum Spannen von Vierkantschäften
- Ideal zur Verwendung an schwer zugänglichen Stellen

- Adjustable for left- and right-hand use
- Sliding cross-handle
- With two jack chuck for holding square-shanks
- Ideal for operations at difficult accessible places

Größe Size	Ausführung Version	M - MF	□ mm	L 1 mm		Artikel-Nr. Part-No.		Artikel-Nr. Part-No.
1	kurz / short	M3 - M10	2,5 - 5,5	85	1	4302 15 00001	1	4302 07 00001
2	kurz / short	M5 - M12	4,5 - 7,0	100	1	4302 15 00002	1	4302 07 00002
10	lang / long	M3 - M10	2,5 - 5,5	250	1	4302 15 00010	-	-
20	lang / long	M5 - M12	4,5 - 7,0	300	1	4302 15 00020	-	-

Gewindebohrer Verlängerungen DIN 377 Extension sleeves DIN 377

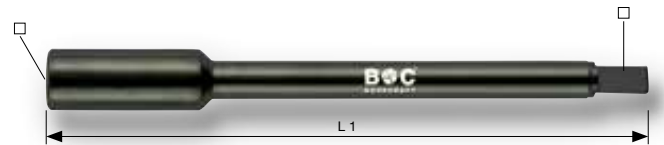

Code **4500**

- Geschliffene und gehärtete Ausführung
- Zur Aufnahme von Vierkantschäften nach DIN 10
- Außen- und Innenvierkant gleich groß

- Ground and hardened version
- For squares according DIN 10
- Inside and outside square with same size

□ mm	M / DIN 352	L 1 mm		Artikel-Nr. Part-No.
2,1	M 1 - M 2,6	60	1	4500 15 00210
2,4	-	70	1	4500 15 00240
2,7	M 3	80	1	4500 15 00270
3,0	M 3,5	90	1	4500 15 00300
3,4	M 4	95	1	4500 15 00340
3,8	-	100	1	4500 15 00380
4,3	-	105	1	4500 15 00430
4,9	M 5 - M 8	110	1	4500 15 00490
5,5	M 9 - M 10	115	1	4500 15 00550
6,2	M 11	120	1	4500 15 00620
7,0	M 12	125	1	4500 15 00700
8,0	-	125	1	4500 15 00800
9,0	M 13 - M 16	135	1	4500 15 00900
10,0	-	140	1	4500 15 01000
11,0	M 18	150	1	4500 15 01100
12,0	M 20	155	1	4500 15 01200
13,0	-	165	1	4500 15 01300
14,5	M 22 - M 24	174	1	4500 15 01450
16,0	M 27	180	1	4500 15 01600
18,0	M 30	200	1	4500 15 01800
20,0	M 33	220	1	4500 15 02000





Code 9700



- Aus hochwertigem CV-Stahl gefertigt.
- Zum Ausdrehen von abgebrochenen Schrauben.

- Made of high-quality chrome-vanadium steel.
- For removing broken screws in threads.

Größe Size	M - MF Für Schrauben For Screws	Zoll / inch Für Schrauben For Screws			Artikel-Nr. Part-No.
1	M 3 - 6	1/8" - 1/4"	2,5	1	9700 07 00001
2	M 6 - 8	1/4" - 5/16"	3,0	1	9700 07 00002
3	M 8 - 11	5/16" - 7/16"	4,5	1	9700 07 00003
4	M 11 - 14	7/16" - 9/16"	6,0	1	9700 07 00004
5	M 14 - 18	9/16" - 3/4"	8,0	1	9700 07 00005
6	M 18 - 24	3/4" - 1"	11,0	1	9700 07 00006
7	M 24 - 33	1" - 1.3/8"	14,0	1	9700 07 00007
8	M 33 - 50	1.3/8" - 2"	21,0	1	9700 07 00008

BC Kunststoff-Kassetten / BC Plastic-Boxes

Bezeichnung Description	Teile Pieces	Inhalt Content		Artikel-Nr. Part-No.
SE 5	5	Größe / Size 1 - 5	1	9700 14 30005
SE 6	6	Größe / Size 1 - 6	1	9700 14 30006
SE 8	8	Größe / Size 1 - 8	1	9700 14 30008



SE 5

Hartmetall Reißnadel
Steel scriber with carbide cutting point



Code **9600**



- Mit Hartmetallspitze und Clip
- Zum Markieren von Metall etc.

- With carbide cutting point and clip
- For marking steel etc.

L mm			Artikel-Nr. Part-No.
140	1	-	9600 07 00140
140	-	10	9600 15 00140













HM REISSNADEL
TCT STEEL SCRIBER

GEWINDEREPARATUR
THREAD REPAIR



GEWINDEREPARATUR
 THREAD REPAIR

	Gewinde Thread	Bezeichnung Description	Code	Seite Page
Gewindereparatur / Thread repair				
		M Gewindeeinsätze Thread inserts	4600 – 4604	248
		MF Gewindeeinsätze Thread inserts	4610 – 4614	248
		MF (ZK / SPARK PLUG) Gewindeeinsätze für Zündkerzengewinde Thread inserts for spark plug thread	4615	249
		M, MF Gewindereparatursätze Thread repair sets	4601 4611 4615	250 – 253
		M, MF, UNC, UNF, BSW Einbauwerkzeuge Fitting-tools	4700	254
		M, MF, UNC, UNF, BSW Zapfenbrecher Pin-breaker	4701	255
		M, MF STI Einschnittgewindebohrer STI short machine taps	4800 – 4801	256
		MF (ZK / SPARK PLUG) STI Kombi-Gewindebohrer STI combined-thread tap	4802	257
Spiralbohrer / Twist drills				
		Spiralbohrer geschliffen, zylindrisch + reduziert Twist drills fully ground, cylindrical + reduced	1121 1121-red.	257



Gewindeeinsätze Thread inserts





Code 4600 - 4614

M

- Frei durchlaufend aus rostfreiem Stahl
- Zur Gewindepanzerung von Werkstoffen geringer Scherfestigkeit, wie z.B. Aluminium- oder Magnesiumlegierungen sowie zur Gewindereparatur abgenutzter oder beschädigter Gewinde.
- Free running made of stainless steel
- Thread reinforcement for materials with low shearing strength, e.g. aluminium and magnesium alloys as well as to repair enables worn and damaged threads.

Ø d mm			L1 = 1,0 x d	L1 = 1,5 x d	L1 = 2,0 x d	L1 = 2,5 x d	L1 = 3,0 x d
M 3 x 0,5	3,20	100	4600 15 00300	4601 15 00300	4602 15 00300	4603 15 00300	4604 15 00300
M 4 x 0,7	4,20	100	4600 15 00400	4601 15 00400	4602 15 00400	4603 15 00400	4604 15 00400
M 5 x 0,8	5,20	100	4600 15 00500	4601 15 00500	4602 15 00500	4603 15 00500	4604 15 00500
M 6 x 1	6,30	100	4600 15 00600	4601 15 00600	4602 15 00600	4603 15 00600	4604 15 00600
M 8 x 1,25	8,30	100	4600 15 00800	4601 15 00800	4602 15 00800	4603 15 00800	4604 15 00800
M 10 x 1,5	10,40	100	4600 15 01000	4601 15 01000	4602 15 01000	4603 15 01000	4604 15 01000
M 12 x 1,75	12,40	50	4600 15 01200	4601 15 01200	4602 15 01200	4603 15 01200	4604 15 01200
M 14 x 2	14,50	50	4600 15 01400	4601 15 01400	4602 15 01400	4603 15 01400	4604 15 01400
M 16 x 2	16,50	50	4600 15 01600	4601 15 01600	4602 15 01600	4603 15 01600	4604 15 01600
M 18 x 2,5	18,60	25	4600 15 01800	4601 15 01800	4602 15 01800	4603 15 01800	4604 15 01800
M 20 x 2,5	20,60	25	4600 15 02000	4601 15 02000	4602 15 02000	4603 15 02000	4604 15 02000
M 22 x 2,5	22,60	10	4600 15 02200	4601 15 02200	4602 15 02200	4603 15 02200	4604 15 02200
M 24 x 3	24,75	10	4600 15 02400	4601 15 02400	4602 15 02400	4603 15 02400	4604 15 02400

MF

Ø d mm			L1 = 1,0 x d	L1 = 1,5 x d	L1 = 2,0 x d	L1 = 2,5 x d	L1 = 3,0 x d
MF 8 x 1	8,30	100	4610 15 00810	4611 15 00810	4612 15 00810	4613 15 00810	4614 15 00810
MF 10 x 1	10,30	100	4610 15 01010	4611 15 01010	4612 15 01010	4613 15 01010	4614 15 01010
MF 10 x 1,25	10,30	100	4610 15 01012	4611 15 01012	4612 15 01012	4613 15 01012	4614 15 01012
MF 12 x 1	12,30	50	4610 15 01210	4611 15 01210	4612 15 01210	4613 15 01210	4614 15 01210
MF 12 x 1,25	12,30	50	4610 15 01212	4611 15 01212	4612 15 01212	4613 15 01212	4614 15 01212
MF 12 x 1,5	12,40	50	4610 15 01215	4611 15 01215	4612 15 01215	4613 15 01215	4614 15 01215
MF 14 x 1	14,30	50	4610 15 01410	4611 15 01410	4612 15 01410	4613 15 01410	4614 15 01410
MF 14 x 1,25	14,40	50	4610 15 01412	4611 15 01412	4612 15 01412	4613 15 01412	4614 15 01412
MF 14 x 1,5	14,40	50	4610 15 01415	4611 15 01415	4612 15 01415	4613 15 01415	4614 15 01415
MF 16 x 1,5	16,40	50	4610 15 01615	4611 15 01615	4612 15 01615	4613 15 01615	4614 15 01615
MF 18 x 1,5	18,50	25	4610 15 01815	4611 15 01815	4612 15 01815	4613 15 01815	4614 15 01815
MF 18 x 2	18,50	25	4610 15 01820	4611 15 01820	4612 15 01820	4613 15 01820	4614 15 01820
MF 20 x 1,5	20,50	25	4610 15 02015	4611 15 02015	4612 15 02015	4613 15 02015	4614 15 02015
MF 20 x 2	20,50	25	4610 15 02020	4611 15 02020	4612 15 02020	4613 15 02020	4614 15 02020
MF 22 x 1,5	22,50	10	4610 15 02215	4611 15 02215	4612 15 02215	4613 15 02215	4614 15 02215
MF 22 x 2	22,50	10	4610 15 02220	4611 15 02220	4612 15 02220	4613 15 02220	4614 15 02220
MF 24 x 1,5	24,50	10	4610 15 02415	4611 15 02415	4612 15 02415	4613 15 02415	4614 15 02415
MF 24 x 2	24,50	10	4610 15 02420	4611 15 02420	4612 15 02420	4613 15 02420	4614 15 02420

Gewindeinsätze für Zündkerzengewinde
Thread inserts for spark plug thread

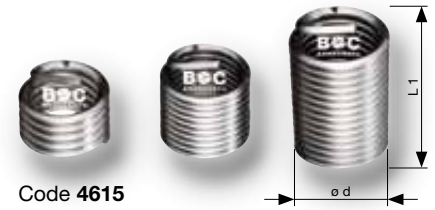

Code 4615

MF

- Frei durchlaufend aus rostfreiem Stahl
- Zur Gewindepanzerung von Werkstoffen geringer Scherfestigkeit, wie z.B. Aluminium- oder Magnesiumlegierungen sowie zur Gewindereparatur abgenutzter oder beschädigter Gewinde.
- Free running made of stainless steel
- Thread reinforcement for materials with low shearing strength, e.g. aluminium and magnesium alloys as well as to repair enables worn and damaged threads.

Ø d mm			L1 = 8,4 x d	L1 = 12,4 x d	L1 = 16,4 x d
M 14 x 2,5	14,40	50	4615 15 14084	4615 15 14124	4615 15 14164



Gewindereparatursätze

Thread repair sets



M

Inhalt:

- Gewindeeinsätze
- Spiralbohrer DIN 338 (BC-Code 1121) bis M12
- STI Gewindebohrer
- Eindrehwerkzeug
- Zapfenbrecher bis M12

Content:

- Thread inserts
- Twist drill DIN 338 (BC-Code 1121) up to M12
- STI tap
- Fitting tool
- Pin breaker up to M12

Bezeichnung Description	Gewinde Thread		STI-Gewb. STI tap	Eindrehwerkz. Fitting tool	Zapfenbrecher Pin breaker	Einsatz / Insert (1,5 x d)	Artikel-Nr. Part-No.
GR-M3	M 3 x 0,5	3,2	M 3 x 0,5	No. 4	No. 4	20	4601 13 30300
GR-M4	M 4 x 0,7	4,2	M 4 x 0,7	No. 6	No. 6	20	4601 13 30400
GR-M5	M 5 x 0,8	5,2	M 5 x 0,8	No. 8	No. 8	20	4601 13 30500
GR-M6	M 6 x 1	6,3	M 6 x 1	No. 9	No. 9	20	4601 13 30600
GR-M8	M 8 x 1,25	8,3	M 8 x 1,25	No. 11	No. 11	20	4601 13 30800
GR-M10	M 10 x 1,5	10,4	M 10 x 1,5	No. 13	No. 13	15	4601 13 31000
GR-M12	M 12 x 1,75	12,4	M 12 x 1,75	No. 15	No. 15	10	4601 13 31200
GR-M14	M 14 x 2	-	M 14 x 2	No. 16	-	10	4601 13 31400
GR-M16	M 16 x 2	-	M 16 x 2	No. 18	-	10	4601 13 31600
GR-M18	M 18 x 2,5	-	M 18 x 2,5	No. 20	-	3	4601 13 31800
GR-M20	M 20 x 2,5	-	M 20 x 2,5	No. 21	-	3	4601 13 32000
GR-M22	M 22 x 2,5	-	M 22 x 2,5	No. 22	-	3	4601 13 32200
GR-M24	M 24 x 3	-	M 24 x 3	No. 23	-	3	4601 13 32400

GEWINDEREPARATUR
THREAD REPAIR



GR-M3 – GR-M12



GR-M14 – GR-M24

Gewindereparatursätze
Thread repair sets



MF

Inhalt:

- Gewindeeinsätze
- Spiralbohrer DIN 338 (BC-Code 1121) bis MF12
- STI Gewindebohrer
- Eindrehwerkzeug
- Zapfenbrecher bis MF12

Content:

- Thread inserts
- Twist drill DIN 338 (BC-Code 1121) up to MF12
- STI tap
- Fitting tool
- Pin breaker up to MF12

Bezeichnung Description	Gewinde Thread		STI-Gewb. STI tap	Eindrehwerkz. Fitting tool	Zapfenbrecher Pin breaker	Einsatz / Insert (1,5 x d)	Artikel-Nr. Part-No.
GR-MF810	MF 8 x 1	8,3	MF 8 x 1	No. 11	No. 11	20	4611 13 30810
GR-MF1010	MF 10 x 1	10,3	MF 10 x 1	No. 13	No. 13	15	4611 13 31010
GR-MF1012	MF 10 x 1,25	10,3	MF 10 x 1,25	No. 13	No. 13	15	4611 13 31012
GR-MF1210	MF 12 x 1	12,3	MF 12 x 1	No. 15	No. 15	10	4611 13 31210
GR-MF1212	MF 12 x 1,25	12,3	MF 12 x 1,25	No. 15	No. 15	10	4611 13 31212
GR-MF1215	MF 12 x 1,5	12,4	MF 12 x 1,5	No. 15	No. 15	10	4611 13 31215
GR-MF1410	MF 14 x 1	-	MF 14 x 1	No. 16	-	10	4611 13 31410
GR-MF1412	MF 14 x 1,25	-	MF 14 x 1,25	No. 16	-	10	4611 13 31412
GR-MF1415	MF 14 x 1,5	-	MF 14 x 1,5	No. 16	-	10	4611 13 31415
GR-MF1615	MF 16 x 1,5	-	MF 16 x 1,5	No. 18	-	10	4611 13 31615
GR-MF1815	MF 18 x 1,5	-	MF 18 x 1,5	No. 20	-	3	4611 13 31815
GR-MF1820	MF 18 x 2	-	MF 18 x 2	No. 20	-	3	4611 13 31820
GR-MF2015	MF 20 x 1,5	-	MF 20 x 1,5	No. 21	-	3	4611 13 32015
GR-MF2020	MF 20 x 2	-	MF 20 x 2	No. 21	-	3	4611 13 32020
GR-MF2215	MF 22 x 1,5	-	MF 22 x 1,5	No. 22	-	3	4611 13 32215
GR-MF2220	MF 22 x 2	-	MF 22 x 2	No. 22	-	3	4611 13 32220
GR-MF2415	MF 24 x 1,5	-	MF 24 x 1,5	No. 23	-	3	4611 13 32415
GR-MF2420	MF 24 x 2	-	MF 24 x 2	No. 23	-	3	4611 13 32420



GR-MF810 – GR-MF1215



GR-MF1410 – GR-MF2420

Gewindereparatursätze

Thread repair sets



M

Inhalt:

- Gewindeeinsätze
- Spiralbohrer DIN 338 (BC-Code 1121) bis M12
- STI Gewindebohrer
- Eindrehwerkzeug
- Zapfenbrecher bis M12

Content:

- Thread inserts
- Twist drill DIN 338 (BC-Code 1121) up to M12
- STI tap
- Fitting tool
- Pin breaker up to M12

Bezeichnung Description	Gewinde Thread		STI-Gewb. STI tap	Eindrehwerkz. Fitting tool	Zapfenbrecher Pin breaker	Einsatz / Insert (1,5 x d)	Artikel-Nr. Part-No.
GR-512 130-tlg. / pcs.	M 5 x 0,8	5,2	M 5 x 0,8	No. 8	No. 8	25	4601 13 31512
	M 6 x 1	6,3	M 6 x 1	No. 9	No. 9	25	
	M 8 x 1,25	8,3	M 8 x 1,25	No. 11	No. 11	25	
	M 10 x 1,5	10,4	M 10 x 1,5	No. 13	No. 13	25	
	M 12 x 1,75	12,4	M 12 x 1,75	No. 15	No. 15	10	
GR-M614* 104-tlg. / pcs.	M 6 x 1	6,3	M 6 x 1	No. 9	No. 9	25	4601 13 30614
	M 8 x 1,25	8,3	M 8 x 1,25	No. 11	No. 11	25	
	M 10 x 1,5	10,4	M 10 x 1,5	No. 13	No. 13	15	
	M 12 x 1,75	12,4	M 12 x 1,75	No. 15	No. 15	10	
	MF 14 x 1,25	14,4	MF 14 x 1,25	No. 16	-	10	

* Nur solange Vorrat reicht / * Only stock out selling quantities

Bezeichnung Description	Gewinde Thread		STI-Gewb. STI tap	Eindrehwerkz. Fitting tool	Zapfenbrecher Pin breaker	Einsatz / Insert (1,0 / 1,5 / 2,5 x d)	Artikel-Nr. Part-No.
GR-M312* 133-tlg. / pcs.	M 3 x 0,5	3,2	M 3 x 0,5	No. 4	No. 4	5	4601 13 30312
	M 4 x 0,7	4,2	M 4 x 0,7	No. 6	No. 6	5	
	M 5 x 0,8	5,2	M 5 x 0,8	No. 8	No. 8	5	
	M 6 x 1	6,3	M 6 x 1	No. 9	No. 9	5	
	M 8 x 1,25	8,3	M 8 x 1,25	No. 11	No. 11	5	
	M 10 x 1,5	10,4	M 10 x 1,5	No. 13	No. 13	5	
	M 12 x 1,75	12,4	M 12 x 1,75	No. 15	No. 15	5	

* Nur solange Vorrat reicht / * Only stock out selling quantities



GR-512



GR-M614



GR-M312

Gewindereparatursatz für Zündkerzengewinde Thread repair set for spark plug



MF

Inhalt:

- Gewindeeinsätze
- STI Gewindebohrer
- Eindrehwerkzeug

Content:

- Thread inserts
- STI combined-thread tap
- Fitting tool

Bezeichnung Description	Gewinde Thread	STI-Gewb. STI tap	Eindrehwerkz. Fitting tool	Einsatz / Insert (8,4 / 12,4 / 16,4 mm)	Artikel-Nr. Part-No.
GRZK-14	MF 14 x 1,25	MF 14 x 1,25	No. 16	5	4615 13 31412



GRZK-14



GEWINDEREPARATUR
THREAD REPAIR

Einbauwerkzeuge
 Fitting-tools

Code 4700



Zum Eindrehen von Gewindeeinsätzen

To screw in the thread inserts

Größe Size	M - MF	UNC	UNF	BSW		Artikel-Nr. Part-No.
4	M 3 x 0,5	Nr. 4 x 40 Nr. 5 x 40	Nr. 4 x 48	1/8" x 40	1	4700 15 00004
6	M 4 x 0,7	Nr. 8 x 32	Nr. 8 x 36	-	1	4700 15 00006
8	M 5 x 0,8	Nr. 12 x 24	Nr. 10 x 32	-	1	4700 15 00008
9	M 6 x 1	1/4" x 20	1/4" x 28	1/4" x 20	1	4700 15 00009
11	M 8 x 1,25 M 8 x 1	-	5/16" x 24	-	1	4700 15 00011
13	M 10 x 1 M 10 x 1,25 M 10 x 1,5	-	3/4" x 24	-	1	4700 15 00013
15	M 12 x 1 M 12 x 1,25 M 12 x 1,5 M 12 x 1,75	1/2" x 13	1/2" x 20	1/2" x 12	1	4700 15 00015
16	M 14 x 1 M 14 x 1,25 M 14 x 1,5 M 14 x 2	9/16" x 12	9/16" x 18	9/16" x 12	1	4700 15 00016
18	M 16 x 1,5 M 16 x 2	5/8" x 11	5/8" x 18	5/8" x 11	1	4700 15 00018
20	M 18 x 1,5 M 18 x 2 M 18 x 2,5	3/4" x 10	-	3/4" x 10	1	4700 15 00020
21	M 20 x 1,5 M 20 x 2 M 20 x 2,5	-	3/4" x 16	-	1	4700 15 00021
22	M 22 x 1,5 M 22 x 2 M 22 x 2,5	7/8" x 9	7/8" x 14	7/8" x 9	1	4700 15 00022
23	M 24 x 1,5 M 24 x 2 M 24 x 3	1" x 8	1" x 12	1" x 8	1	4700 15 00023



Zapfenbrecher
Pin-breaker



Code 4701

- M
- MF
- UNC
- UNF
- BSW

Zum Entfernen der Mitnehmerzapfen in Gewindeeinsätzen

To remove the tang of the thread insert

Größe Size	M - MF	UNC	UNF	BSW		Artikel-Nr. Part-No.
4	M 3 x 0,5	Nr. 4 x 40 Nr. 5 x 40	Nr. 4 x 48	1/8" x 40	1	4701 15 00004
6	M 4 x 0,7	Nr. 8 x 32	Nr. 8 x 36	-	1	4701 15 00006
8	M 5 x 0,8	Nr. 12 x 24	Nr. 10 x 32	-	1	4701 15 00008
9	M 6 x 1	1/4" x 20	1/4" x 28	1/4" x 20	1	4701 15 00009
11	M 8 x 1,25 M 8 x 1 M 10 x 1	-	5/16" x 24	-	1	4701 15 00011
13	M 10 x 1,25 M 10 x 1,5 M 12 x 1	-	3/4" x 24	-	1	4701 15 00013
15	M 12 x 1,25 M 12 x 1,5 M 12 x 1,75	1/2" x 13	1/2" x 20	1/2" x 12	1	4701 15 00015

Ab M 14 den Zapfen mit einer Zange oder einem anderen Gegenstand entfernen.
From size M 14 please remove the tang with a long-nosed pliers or another object.



STI Einschnittgewindebohrer HSS-G

STI short machine taps HSS-G

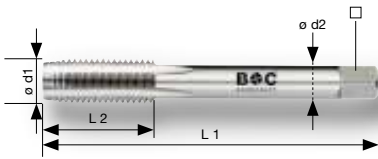

Code 4800 • 4801



- Zum Schneiden von Innengewinden für Gewindeeinsätze nach ISO 2 (6H)
- Für Hand- und Maschinengebrauch
- Form D = 4 – 5 Gang Anschnitt

- For cutting internal threads for thread inserts according to ISO 2 (6H)
- For manual and machine use
- Form D = 4 – 5 threads lead

Ø d1 mm		L 1 mm	L 2 mm	Ø d2 mm			Artikel-Nr. Part-No.
M 3 x 0,5	3,20	53	13	4,0	3,15	1	4800 11 00300
M 4 x 0,7	4,20	58	16	5,0	4,0	1	4800 11 00400
M 5 x 0,8	5,20	66	19	6,3	5,0	1	4800 11 00500
M 6 x 1	6,30	72	22	8,0	6,3	1	4800 11 00600
M 8 x 1,25	8,30	80	24	10,0	8,0	1	4800 11 00800
M 10 x 1,5	10,40	89	29	9,0	7,1	1	4800 11 01000
M 12 x 1,75	12,40	95	30	11,2	9,0	1	4800 11 01200
M 14 x 2	14,50	102	32	12,5	10,0	1	4800 11 01400
M 16 x 2	16,50	112	37	14,0	11,2	1	4800 11 01600
M 18 x 2,5	18,60	118	38	16,0	12,5	1	4800 11 01800
M 20 x 2,5	20,60	118	38	16,0	12,5	1	4800 11 02000
M 22 x 2,5	22,60	130	45	20,3	14,0	1	4800 11 02200
M 24 x 3	24,75	138	48	23,0	16,0	1	4800 11 02400

Ø d1 mm		L 1 mm	L 2 mm	Ø d2 mm			Artikel-Nr. Part-No.
MF 8 x 1	8,3	80	24	10,0	8,0	1	4801 11 00810
MF 10 x 1	10,3	85	25	8,0	6,3	1	4801 11 01010
MF 10 x 1,25	10,3	85	25	8,0	6,3	1	4801 11 01012
MF 12 x 1	12,3	95	30	10,9	9,0	1	4801 11 01210
MF 12 x 1,25	12,3	95	30	11,2	9,0	1	4801 11 01212
MF 12 x 1,5	12,4	95	30	11,2	9,0	1	4801 11 01215
MF 14 x 1	14,3	102	32	12,5	10,0	1	4801 11 01410
MF 14 x 1,25	14,4	102	32	12,5	10,0	1	4801 11 01412
MF 14 x 1,5	14,4	102	32	12,5	10,0	1	4801 11 01415
MF 16 x 1,5	16,4	104	29	14,0	11,2	1	4801 11 01615
MF 18 x 1,5	18,5	104	29	14,0	11,2	1	4801 11 01815
MF 18 x 2	18,5	104	29	16,0	11,2	1	4801 11 01820
MF 20 x 1,5	20,5	113	33	16,0	12,5	1	4801 11 02015
MF 20 x 2	20,5	113	33	16,0	12,5	1	4801 11 02020
MF 22 x 1,5	22,5	120	35	19,3	14,0	1	4801 11 02215
MF 22 x 2	22,5	120	35	20,3	14,0	1	4801 11 02220
MF 24 x 1,5	24,5	120	35	18,0	14,0	1	4801 11 02415
MF 24 x 2	24,5	127	37	20,0	16,0	1	4801 11 02420



STI Kombi-Gewindebohrer HSS-G, speziell für Zündkerzen STI combined-thread tap HSS-G, especially for spark plugs

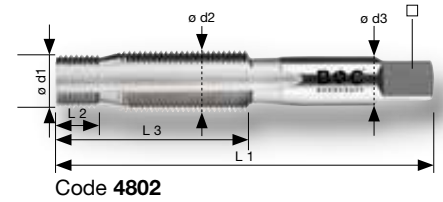

- Speziell für die Reparatur von Zündkerzengewinde
- Für Hand- und Maschinengebrauch
- Mit Führungszapfen
- Keine Kernlochbohrung notwendig

- Especially for repair of spark plug threads
- For manual and machine use
- With pilot-nose
- No need to drill a core hole

MF	Ø d1 mm	Ø d2 mm	Ø d3 mm	L1 mm	L2 mm	L3 mm	mm		Artikel-Nr. Part-No.
MF 14 x 1,25	14	15,6	12	90	10	45	9,2	1	4802 11 01412



Spiralbohrer DIN 338 HSS-G Typ N, Kreuzanschliff Twist drills DIN 338 HSS-G type N, split point



Code 1121 (≤ 12,4 mm)

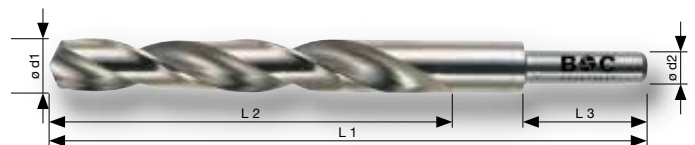

Code 1121-red. (≥ 14,3 mm)













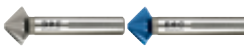

































Für Stahl und Stahlguss legiert und unlegiert, Grau- und Temperguss, Sphäro- und Druckguss, Sinterisen, Graphit, kurzspanende Aluminiumlegierungen, Messing und Bronze.

















































































For steel and cast steel alloyed and unalloyed, cast iron, annealed cast iron, ductile graphite iron, diecast, short-chipping aluminium-alloy, brass and bronze.

Ø d1 mm	L1 mm	L2 mm	Ø d2 mm	L3 mm	Für Gewinde For thread		Artikel-Nr. Part-No.
3,20	65	36	zyl. / cyl.	-	M 3 x 0,50	10	1121 01 00320
4,20	75	43	zyl. / cyl.	-	M 4 x 0,70	10	1121 01 00420
5,20	86	52	zyl. / cyl.	-	M 5 x 0,80	10	1121 01 00520
6,30	101	63	zyl. / cyl.	-	M 6 x 1,00	10	1121 01 00630
8,30	117	75	zyl. / cyl.	-	M 8 x 1,00 / M 8 x 1,25	10	1121 01 00830
10,30	133	87	zyl. / cyl.	-	M 10 x 1,00 / M 10 x 1,25	5	1121 01 01030
10,40	133	87	zyl. / cyl.	-	M 10 x 1,50	5	1121 01 01040
12,30	151	101	zyl. / cyl.	-	M 12 x 1,00 / M 12 x 1,25	5	1121 01 01230
12,40	151	101	zyl. / cyl.	-	M 12 x 1,75 / M 12 x 1,50	5	1121 01 01240
14,30	169	114	13	30	M 14 x 1,00	1	1121 01 11430
14,40	169	114	13	30	M 14 x 1,25 / M 14 x 1,50	1	1121 01 11440
14,50	169	114	13	30	M 14 x 2,00	1	1121 01 11450
16,40	184	125	13	35	M 16 x 1,50	1	1121 01 11640
16,50	184	125	13	35	M 16 x 2,00	1	1121 01 11650
18,50	198	135	13	35	M 18 x 1,50 / M 18 x 2,00	1	1121 01 11850
18,60	198	135	13	35	M 18 x 2,50	1	1121 01 11860
20,50	225	145	13	40	M 20 x 1,50 / M 20 x 2,00	1	1121 01 12050
20,60	225	145	13	40	M 20 x 2,50	1	1121 01 12060
22,50	230	155	13	40	M 22 x 1,50 / M 22 x 2,00	1	1121 01 12250
22,60	230	155	13	40	M 22 x 2,50	1	1121 01 12260
24,50	250	160	13	40	M 24 x 1,50 / M 24 x 2,00	1	1121 01 12450
24,75	250	160	13	40	M 24 x 3,00	1	1121 01 12475



SENKER · BLECHSCHÄLBOHRER · STUFENBOHRER COUNTERSINKS · SHEET METAL DRILLS · STEP DRILLS

	DIN	Qualität Quality	Typ Type	Bezeichnung Description	Code	Seite Page
Senker / Countersinks						
 	335 C	HSS AlCro	90°	Kegeisenker, UNGLEICHE TEILUNG Countersinks, UNEQUAL PITCH	1730 1731	264
 	335 C	HSS-E blue+	90°	Kegeisenker, UNGLEICHE TEILUNG Countersinks, UNEQUAL PITCH	1732 1733	265
 	335 C	VHM/SC blue+	90°	Kegeisenker, UNGLEICHE TEILUNG Countersinks, UNEQUAL PITCH	1715 1719	266
 	335 C	HSS-E PM	90°	Kegeisenker Pulvermetall Countersinks powder metal	1714	267
 	335 C	HSS TiN TiALN	90°	Kegeisenker Countersinks	1700 -	268
 	335 C	HSS-E Co5	90°	Kegeisenker kobaltlegiert Countersinks cobalt alloyed	1710	269
 	335 C	HSS	90°	Kegeisenker, lange / extra lange Ausführung Countersinks, long / extra long version	1703-L 1703-EL	270
 	BC Norm	HSS	90°	Kegeisenker-Bits 1/4" Schaft Countersinks, 1/4" hex-shank	1705	271
 		HSS	90°	Handentgrater Hand deburring tools	1820	271
 	335 D	HSS	90°	Kegeisenker mit Morsekegelschaft Countersinks with taper shank	1704	272
 	334 C	HSS	60°	Kegeisenker Countersinks	1700-60	272
 	BC Norm	HSS	75°	Kegeisenker Countersinks	1700-75	273
 	BC Norm	HSS	120°	Kegeisenker Countersinks	1700-120	273
 	BC Norm	HSS TiN	90°	Kegel- und Entgratsenker mit Querloch Countersinks with cross hole	1720 1721	274
 	373	HSS TiN	180°	Flachsenker Flat countersinks	1706 -	275
 					1718	
Mehrfasenstufenbohrer / Subland drills						
 	8374 8376	HSS-G	90° 180°	Mehrfasenstufenbohrer Subland drills	1625 1626	276
Stufenbohrer / Step Drills						
 	BC Norm	HSS TiN blue+		Stufenbohrer mit Spiralnut Step drills with spiral flute	1763 -	278
 	BC Norm	HSS-E Co5 blue+		Stufenbohrer mit Spiralnut Step drills with spiral flute	1765 1766	279
 	BC Norm	HSS TiN TiALN		Stufenbohrer Step drills	1760 -	280
 	BC Norm	HSS		Stufenbohrer mit 1/4" Schaft Step drills with 1/4" hex-shank	1760-1/4"	281
Blechsälbohrer / Sheet metal drills						
 	BC Norm	HSS TiN TiALN		Blechsälbohrer Sheet metal drills	1740 -	282
 	BC Norm	HSS-E Co5		Blechsälbohrer kobaltlegiert Sheet metal drills cobalt alloyed	1743	283
 	BC Norm	HSS TiN		Blechsälbohrer mit Anschlag Sheet metal drills with backstop	1740-A 1741-A	283

									
DIN	335	335	335	335	335	335	335	334	-
Form Type	C	C	C	C	C	C	D	C	C
Schneidstoff Cutting material	HSS	HSS	HSS	HSS	HSS	HSS	HSS	HSS	HSS
Beschichtung Coating	-	TiN	TiALN	-	AlCro	-	-	-	-
Senkwinkel Cutting angle	90°	90°	90°	90°	90°	90°	90°	60°	75°
Schaft Shank	zyl. cyl.	zyl. cyl.	zyl. cyl.	3-kant 3-flat	3-kant 3-flat	zyl. cyl.	MK MT	zyl. cyl.	zyl. cyl.
Bereich Range	4,3 – 50,0 mm	4,3 – 31,0 mm	4,3 – 31,0 mm	6,3 – 40,0 mm	6,3 – 40,0 mm	6,3 – 20,5 mm	15 – 120 mm	6,3 – 30,0 mm	6,3 – 25,0 mm
Qualität Quality	★★★★★	★★★★★	★★★★★	★★★★★★	★★★★★★	★★★★★	★★★★★	★★★★★	★★★★★
Code	1700	1701	1702	1730	1731	1703	1704	1700-60	1700-75
Seite Page	268	268	268	264	264	270	272	272	273
P	1.1 – 2.1								
	3.1 – 4.1								
	5.1								
M	1.1 – 2.1								
	3.1 – 4.1								
K	1.1 – 1.2								
	2.1 – 2.2								
	3.1 – 3.2								
	4.1 – 4.2								
N	1.1 – 1.5								
	2.1								
	2.2 – 2.3								
	4.1 – 4.2								
S	1.1 – 1.2								
	2.1 – 2.6								
H	1.1								
	1.2								

 geeignet / suitable  bedingt geeignet / limited suitable









TECHNISCHE DETAILS
TECHNICAL DETAILS

										
-	335	335	335	335	335	335	-	-	-	373
C	C	C	C	C	C	C	-	-	-	-
HSS	HSS-E Co5	HSS-E Co5	HSS-E Co5	HSS-E PM	VHM SC	VHM SC	HSS	HSS	HSS	HSS
-	-	-	blue+	-	-	blue+	-	-	TiN	-
120°	90°	90°	90°	90°	90°	90°	90°	90°	90°	180°
zyl. cyl.	zyl. cyl.	3-kant 3-flat	3-kant 3-flat	zyl. cyl.	zyl. cyl.	zyl. cyl.	1/4" 6-kant 1/4" hex	zyl. cyl.	zyl. cyl.	zyl. cyl.
6,3 – 25,0 mm	6,3 – 50,0 mm	6,3 – 31,0 mm	6,3 – 31,0 mm	6,3 – 31,0 mm	6,3 – 31,0 mm	6,3 – 31,0 mm	6,3 – 25,0 mm	2 – 30 mm	2 – 25 mm	M3 – M12
★★★★★	★★★★★	★★★★★	★★★★★	★★★★★	★★★★★	★★★★★	★★★★	★★★★	★★★★	★★★★
1700-120	1710	1732	1733	1714	1715	1719	1705	1720	1721	1706 – 1708
273	269	265	265	267	266	266	271	274	274	275
⊕	⊕	⊕	⊕	⊕	⊕	⊕	⊕	⊕	⊕	⊕
	⊕	⊕	⊕	⊕	⊕	⊕			⊕	
	⊕	⊕	⊕	⊕	⊕	⊕			⊕	
	⊕	⊕	⊕	⊕	⊕	⊕			⊕	
			⊕	⊕	⊕	⊕				
⊕	⊕	⊕	⊕	⊕	⊕	⊕	⊕	⊕	⊕	⊕
⊕	⊕	⊕	⊕	⊕	⊕	⊕	⊕	⊕	⊕	⊕
⊕	⊕	⊕	⊕	⊕	⊕	⊕	⊕	⊕	⊕	⊕
⊕	⊕	⊕	⊕	⊕	⊕	⊕	⊕	⊕	⊕	⊕
⊕	⊕	⊕	⊕	⊕	⊕	⊕	⊕	⊕	⊕	⊕
	⊕	⊕	⊕	⊕	⊕	⊕			⊕	
				⊕	⊕	⊕				
				⊕	⊕	⊕				

⊕ geeignet / suitable ⊕ bedingt geeignet / limited suitable



TECHNISCHE DETAILS
TECHNICAL DETAILS

									
DIN	373	8374	8376	-	-	-	-	-	-
Form Type	-	-	-	-	-	-	-	-	-
Schneidstoff Cutting material	HSS	HSS	HSS	HSS	HSS	HSS	HSS-E Co5	HSS-E Co5	HSS
Beschichtung Coating	TiN	-	-	-	TiN	blue+	-	blue+	-
Senkwinkel Cutting angle	180°	90°	180°	-	-	-	-	-	-
Schaft Shank	zyl. cyl.	zyl. cyl.	zyl. cyl.	3-kant 3-flat	3-kant 3-flat	3-kant 3-flat	3-kant 3-flat	3-kant 3-flat	3-kant 3-flat
Bereich Range	M3 – M12	M3 – M10	M3 – M10	4,0 – 40,5 mm	4,0 – 40,5 mm	4,0 – 40,5 mm	4 – 39 mm	4 – 39 mm	4,0 – 40,5 mm
Qualität Quality	★★★★	★★★★	★★★★	★★★★★	★★★★★	★★★★★	★★★★★	★★★★★	★★★★
Code	1716 – 1718	1625	1626	1763	1764	1767	1765	1766	1760
Seite Page	275	276	276	278	278	278	279	279	280
P	1.1 – 2.1	☉	☉	☉	☉	☉	☉	☉	☉
	3.1 – 4.1	☉			☉	☉	☉	☉	
	5.1					☉	☉	☉	
M	1.1 – 2.1	☉			☉	☉	☉	☉	
	3.1 – 4.1							☉	
K	1.1 – 1.2	☉	☉	☉	☉	☉	☉	☉	☉
	2.1 – 2.2	☉	☉	☉	☉	☉	☉	☉	☉
	3.1 – 3.2								
	4.1 – 4.2	☉	☉	☉	☉	☉	☉	☉	☉
N	1.1 – 1.5		☉	☉	☉		☉		☉
	2.1	☉	☉	☉	☉	☉	☉	☉	☉
	2.2 – 2.3		☉	☉	☉		☉	☉	☉
	4.1 – 4.2	☉	☉	☉	☉	☉	☉	☉	☉
S	1.1 – 1.2	☉			☉	☉	☉	☉	
	2.1 – 2.6								
H	1.1								
	1.2								

☉ geeignet / suitable ☉ bedingt geeignet / limited suitable



TECHNISCHE DETAILS
TECHNICAL DETAILS

								
-	-	-	-	-	-	-	-	-
-	-	-	-	-	-	-	-	-
HSS	HSS	HSS	HSS	HSS	HSS	HSS	HSS	HSS-E Co5
TiN	TiALN	-	-	TiN	TiALN	-	TiN	-
-	-	-	-	-	-	-	-	-
3-kant 3-flat	3-kant 3-flat	1/4" 6-kant 1/4" hex	3-kant 3-flat	3-kant 3-flat	3-kant 3-flat	3-kant 3-flat	3-kant 3-flat	3-kant 3-flat
4,0 – 40,5 mm	4,0 – 40,5 mm	4 – 30 mm	3 – 50 mm	3 – 50 mm	3 – 50 mm	2,5 – 15,0 mm	2,5 – 15,0 mm	3,0 – 30,5 mm
★★★★	★★★★	★★★★	★★★★	★★★★	★★★★	★★★★	★★★★	★★★★
1761	1762	1760-1/4"	1740	1741	1742	1740-A	1741-A	1743
280	280	281	282	282	282	283	283	283
☉	☉	☉	☉	☉	☉	☉	☉	☉
☉	☉			☉	☉		☉	☉
	☉				☉			☉
☉	☉			☉	☉		☉	☉
☉	☉	☉	☉	☉	☉	☉	☉	☉
☉	☉	☉	☉	☉	☉	☉	☉	☉
☉	☉	☉	☉	☉	☉	☉	☉	☉
☉	☉	☉	☉	☉	☉	☉	☉	☉
☉	☉	☉	☉	☉	☉	☉	☉	☉
☉	☉			☉	☉		☉	☉

☉ geeignet / suitable ☉ bedingt geeignet / limited suitable



TECHNISCHE DETAILS
TECHNICAL DETAILS

Präzisions-Kegelsenker HSS DIN 335 C 90°, UNGLEICHE TEILUNG

Precision-countersinks HSS DIN 335 C 90°, UNEQUAL PITCH



Code 1730



Code 1731



Code	P			M		K				N				S
	1.1 - 2.1	3.1 - 4.1	5.1	1.1 - 2.1	3.1 - 4.1	1.1 - 1.2	2.1 - 2.2	3.1 - 3.2	4.1 - 4.2	1.1 - 1.5	2.1	2.2 - 2.3	4.1 - 4.2	1.1 - 1.2
1730	☉	☉	☉			☉	☉	☉	☉	☉	☉	☉	☉	☉
1731	☉	☉	☉	☉		☉	☉	☉	☉					

Präzisions Kegelsenker mit ungleicher Teilung und speziell geschliffenen Spannuten. Perfekte Ergebnisse in verschiedenen Werkstoffen wie z.B. allgemeinen Baustählen, NE-Metallen und Gusseisen.

- Ungleiche Teilung garantiert hohe Laufruhe ohne Rattermarken
- Optimierte Spannuten für ideale Span- und Wärmeabfuhr
- Verringerung der Vorschubkraft
- Perfekte Kraftübertragung durch 3-Flächenschaft
- AlCro-Beschichtung für glattere Oberflächen und höhere Standzeit

Precision countersink with unequal pitch and specially grinded flutes. Perfect results in various materials such as general structural steels, non-ferrous metals and cast iron.

- The unequal pitch guarantees smooth running and chatter-free work
- Optimized flutes ensure ideal chip and heat removal
- Reduction in feed force
- Perfect power transmission due to the triangle shank
- AlCro coating for smoother surfaces and longer tool life

Ø d2 mm	Ø d1 mm	Ø d3 mm	L 1 mm	DIN 74 BF		Al-Cro	
						Artikel-Nr. Part-No.	Artikel-Nr. Part-No.
6,3	1,5	5	45	M 3	1	1730 03 06390	1731 03 06390
8,3	2,0	6	50	M 4	1	1730 03 08390	1731 03 08390
10,4	2,5	6	50	M 5	1	1730 03 10490	1731 03 10490
12,4	2,8	8	56	M 6	1	1730 03 12490	1731 03 12490
16,5	3,2	10	60	M 8	1	1730 03 16590	1731 03 16590
20,5	3,5	10	63	M 10	1	1730 03 20590	1731 03 20590
25,0	3,8	10	67	M 12	1	1730 03 25090	1731 03 25090
31,0	4,2	12	71	M 16	1	1730 03 31090	1731 03 31090
40,0	4,2	13	80	-	1	1730 03 40090	1731 03 40090

BC Boxen / BC Boxes

Bezeichnung Description	Teile Pieces	Inhalt Content	Artikel-Nr. Part-No.
KS 3 UT	3	Ø 12,4 · 16,5 · 20,5 mm	1730 13 30003
KS 5-K UT	5	Ø 6,3 · 10,4 · 16,5 · 20,5 · 25,0 mm	1730 13 30005
KS 6-K UT	6	Ø 6,3 · 8,3 · 10,4 · 12,4 · 16,5 · 20,5 mm	1730 13 30006
KS 3 Al-Cro	3	Ø 12,4 · 16,5 · 20,5 mm	1731 13 30003
KS 5-K Al-Cro	5	Ø 6,3 · 10,4 · 16,5 · 20,5 · 25,0 mm	1731 13 30005
KS 6-K Al-Cro	6	Ø 6,3 · 8,3 · 10,4 · 12,4 · 16,5 · 20,5 mm	1731 13 30006

BC Runddose / BC Round-Box

KS 5 UT	5	Ø 6,3 · 10,4 · 16,5 · 20,5 · 25,0 mm	1730 13 32005
KS 5 Al-Cro	5	Ø 6,3 · 10,4 · 16,5 · 20,5 · 25,0 mm	1731 13 32005



KS 5-K Al-Cro



KS 3 Al-Cro



KS 5 UT

Präzisions-Kegelsenker HSS-E (Co5) DIN 335 C 90°, UNGLEICHE TEILUNG Precision-countersinks HSS-E (Co5) DIN 335 C 90°, UNEQUAL PITCH



Code 1732

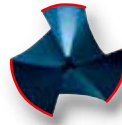

Code 1733



Code	P			M		K				N			S	
	1.1 - 2.1	3.1 - 4.1	5.1	1.1 - 2.1	3.1 - 4.1	1.1 - 1.2	2.1 - 2.2	3.1 - 3.2	4.1 - 4.2	1.1 - 1.5	2.1	2.2 - 2.3	4.1 - 4.2	1.1 - 1.2
1732	⊗	⊗	⊗	⊗	⊗	⊗	⊗	⊗	⊗	⊗	⊗	⊗	⊗	⊗
1733	⊗	⊗	⊗	⊗	⊗	⊗	⊗	⊗	⊗	⊗	⊗	⊗	⊗	⊗

Präzisions Kegelsenker aus HSS-E für rost- und säurebeständige Stähle. Mit ungleicher Teilung und speziell geschliffenen Spannuten.

- Ungleiche Teilung garantiert hohe Laufruhe ohne Rattermarken
- Optimierte Spannuten für ideale Span- und Wärmeabfuhr
- Verringerung der Vorschubkraft
- Perfekte Kraftübertragung durch 3-Flächenschaft
- blue+ Multilayer-Beschichtung für optimierte Standzeiten

Precision countersink made of HSS-E for stainless steels. With unequal pitch and specially grinded flutes.

- The unequal pitch guarantees smooth running and chatter-free work
- Optimized flutes ensure ideal chip and heat removal
- Reduction in feed force
- Perfect power transmission due to the triangle shank
- blue+ multilayer coating for optimized tool life

Ø d2 mm	Ø d1 mm	Ø d3 mm	L 1 mm	DIN 74 BF	⊗	blue+	
						Artikel-Nr. Part-No.	Artikel-Nr. Part-No.
6,3	1,5	5	45	M 3	1	1732 03 06390	1733 03 06390
8,3	2,0	6	50	M 4	1	1732 03 08390	1733 03 08390
10,4	2,5	6	50	M 5	1	1732 03 10490	1733 03 10490
12,4	2,8	8	56	M 6	1	1732 03 12490	1733 03 12490
16,5	3,2	10	60	M 8	1	1732 03 16590	1733 03 16590
20,5	3,5	10	63	M 10	1	1732 03 20590	1733 03 20590
25,0	3,8	10	67	M 12	1	1732 03 25090	1733 03 25090
31,0	4,2	12	71	M 16	1	1732 03 31090	1733 03 31090

BC Boxen / BC Boxes

Bezeichnung Description	Teile Pieces	Inhalt Content	Artikel-Nr. Part-No.
KS 3 Co UT	3	Ø 12,4 · 16,5 · 20,5 mm	1732 13 30003
KS 5-K Co UT	5	Ø 6,3 · 10,4 · 16,5 · 20,5 · 25,0 mm	1732 13 30005
KS 6-K Co UT	6	Ø 6,3 · 8,3 · 10,4 · 12,4 · 16,5 · 20,5 mm	1732 13 30006
KS 3 Co B+	3	Ø 12,4 · 16,5 · 20,5 mm	1733 13 30003
KS 5-K Co B+	5	Ø 6,3 · 10,4 · 16,5 · 20,5 · 25,0 mm	1733 13 30005
KS 6-K Co B+	6	Ø 6,3 · 8,3 · 10,4 · 12,4 · 16,5 · 20,5 mm	1733 13 30006
BC Runddose / BC Round-Box			
KS 5 Co UT	5	Ø 6,3 · 10,4 · 16,5 · 20,5 · 25,0 mm	1732 13 32005
KS 5 Co B+	5	Ø 6,3 · 10,4 · 16,5 · 20,5 · 25,0 mm	1733 13 32005



KS 6-K Co B+



KS 3 Co B+



KS 5 Co UT

VHM Präzisions-Kegelsenker DIN 335 C 90°, UNGLEICHE TEILUNG

Solide carbide precision-countersinks DIN 335 C 90°, UNEQUAL PITCH



Code 1715

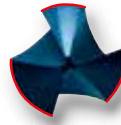

Code 1719



Code	P			M		K				N		S	H			
	1.1 - 2.1	3.1 - 4.1	5.1	1.1 - 2.1	3.1 - 4.1	1.1 - 1.2	2.1 - 2.2	3.1 - 3.2	4.1 - 4.2	1.1 - 1.5	2.1	2.2 - 2.3	4.1 - 4.2	1.1 - 2.6	1.1	1.2
1715	⊕	⊕	⊕	⊕	⊕	⊕	⊕	⊕	⊕	⊕	⊕	⊕	⊕	⊕	⊕	⊕
1719	⊕	⊕	⊕	⊕	⊕	⊕	⊕	⊕	⊕	⊕	⊕	⊕	⊕	⊕	⊕	⊕

Premium Kegelsenker aus Vollhartmetall. Hohe Härte und Temperaturbeständigkeit sowie Verschleißfestigkeit im Vergleich zu normalen HSS Werkzeugen, ermöglicht hervorragende Standzeiten auch in hochfesten Stählen ≤ 55 HRC.

- Ungleiche Teilung garantiert hohe Laufruhe ohne Rattermarken
- Optimierte Spannuten für ideale Span- und Wärmeabfuhr
- Verringerung der Vorschubkraft
- blue+ Multilayer-Beschichtung für optimierte Standzeiten

Premium countersink made of solid carbide. High hardness and temperature resistance as well as wear resistance compared to normal HSS tools, enables excellent tool life even in high-strength steels ≤ 55 HRC.

- The unequal pitch guarantees smooth running and chatter-free work
- Optimized flutes ensure ideal chip and heat removal
- Reduction in feed force
- blue+ multilayer coating for optimized tool life

Ø d2 mm	Ø d1 mm	Ø d3 mm	L 1 mm	DIN 74 BF		blue+	
						Artikel-Nr. Part-No.	Artikel-Nr. Part-No.
6,3	1,5	5	45	M 3	1	1715 03 06390	1719 03 06390
8,3	2,0	6	50	M 4	1	1715 03 08390	1719 03 08390
10,4	2,5	6	50	M 5	1	1715 03 10490	1719 03 10490
12,4	2,8	8	56	M 6	1	1715 03 12490	1719 03 12490
16,5	3,2	10	60	M 8	1	1715 03 16590	1719 03 16590
20,5	3,5	10	63	M 10	1	1715 03 20590	1719 03 20590
25,0	3,8	10	67	M 12	1	1715 03 25090	1719 03 25090
31,0	4,2	12	71	M 16	1	1715 03 31090	1719 03 31090

BC Boxen / BC Boxes

Bezeichnung Description	Teile Pieces	Inhalt Content	Artikel-Nr. Part-No.
KS 3 HM	3	Ø 12,4 · 16,5 · 20,5 mm	1715 13 30003
KS 5-K HM	5	Ø 6,3 · 10,4 · 16,5 · 20,5 · 25,0 mm	1715 13 30005
KS 6-K HM	6	Ø 6,3 · 8,3 · 10,4 · 12,4 · 16,5 · 20,5 mm	1715 13 30006
KS 3 HM B+	3	Ø 12,4 · 16,5 · 20,5 mm	1719 13 30003
KS 5-K HM B+	5	Ø 6,3 · 10,4 · 16,5 · 20,5 · 25,0 mm	1719 13 30005
KS 6-K HM B+	6	Ø 6,3 · 8,3 · 10,4 · 12,4 · 16,5 · 20,5 mm	1719 13 30006
BC Runddose / BC Round-Box			
KS 5 HM	5	Ø 6,3 · 10,4 · 16,5 · 20,5 · 25,0 mm	1715 13 32005
KS 5 HM B+	5	Ø 6,3 · 10,4 · 16,5 · 20,5 · 25,0 mm	1719 13 32005



KS 6-K HM B+



KS 3 HM B+



KS 5 HM



KEGELSENKER
COUNTERSINKS

PM Präzisions-Kegelsenker DIN 335 C 90° **Pulvermetall HSS-E**
PM Precision-countersinks DIN 335 C 90° **powder metal HSS-E**



Code 1714



Code	P			M		K			N		S	H				
	1.1 - 2.1	3.1 - 4.1	5.1	1.1 - 2.1	3.1 - 4.1	1.1 - 1.2	2.1 - 2.2	3.1 - 3.2	4.1 - 4.2	1.1 - 1.5	2.1	2.2 - 2.3	4.1 - 4.2	1.1 - 2.6	1.1	1.2
1714	⊕	⊕	⊕	⊕	⊕	⊕	⊕	⊕	⊕	⊕	⊕	⊕	⊕	⊕	⊕	⊕

Premium Kegelsenker aus pulvermetallurgisch hergestelltem Hochleistungsschnellstahl. Die homogene Gefügestruktur und die dadurch erreichte hohe Schneidkantenstabilität sorgen für eine sehr gute Verschleißbeständigkeit. Speziell zur Bearbeitung höherlegierter Stähle wie z.B. VA/INOX sowie Titan- und Titanlegierungen geeignet.

Premium countersink made of powder metal high speed steels. The homogeneous microstructure and the resulting high cutting edge stability ensure very good wear resistance. Particularly suitable for machining higher-alloyed steels such as INOX as well as titanium and titanium alloys.

Ø d2 mm	Ø d1 mm	Ø d3 mm	L 1 mm	DIN 74 BF		Artikel-Nr. Part-No.
6,3	1,5	5	45	M 3	1	1714 03 06390
8,3	2,0	6	50	M 4	1	1714 03 08390
10,4	2,5	6	50	M 5	1	1714 03 10490
12,4	2,8	8	56	M 6	1	1714 03 12490
16,5	3,2	10	60	M 8	1	1714 03 16590
20,5	3,5	10	63	M 10	1	1714 03 20590
25,0	3,8	10	67	M 12	1	1714 03 25090
31,0	4,2	12	71	M 16	1	1714 03 31090

BC ABS-Box / BC ABS-Box

Bezeichnung Description	Teile Pieces	Inhalt Content	Artikel-Nr. Part-No.
KS 6-K PM	6	Ø 6,3 · 8,3 · 10,4 · 12,4 · 16,5 · 20,5 mm	1714 13 30006



KS 6-K PM



KEGELSENKER
COUNTERSINKS

Kegelsenker DIN 335 Form C 90° HSS

Countersinks DIN 335 type C 90° HSS



Code 1700



Code 1701



Code 1702



Code	P			M		K				N				S
	1.1 - 2.1	3.1 - 4.1	5.1	1.1 - 2.1	3.1 - 4.1	1.1 - 1.2	2.1 - 2.2	3.1 - 3.2	4.1 - 4.2	1.1 - 1.5	2.1	2.2 - 2.3	4.1 - 4.2	1.1 - 1.2
1700	⊗					⊗	⊗		⊗	⊗	⊗	⊗	⊗	⊗
1701	⊗	⊗		⊗		⊗	⊗		⊗	⊗	⊗	⊗	⊗	⊗
1702	⊗	⊗	⊗	⊗		⊗	⊗		⊗	⊗	⊗	⊗	⊗	⊗

CBN-geschliffener Kegelsenker aus HSS zum grat- und ratterfreien Entgraten und Senken in normalharten Werkstoffen wie allgemeinen Baustählen, NE-Metallen und Gusseisen.

CBN-ground countersink made of HSS for burr- and chatter-free deburring and countersinking in normal hard materials such as general structural steels, non-ferrous metals and cast iron.

Ø d2 mm	Ø d1 mm	Ø d3 mm	L 1 mm	DIN 74 AF	DIN 74 BF		TiN		TiAlN
							Artikel-Nr. Part-No.	Artikel-Nr. Part-No.	Artikel-Nr. Part-No.
4,3	1,3	4	40			1	1700 03 04390	1701 03 04390	1702 03 04390
5,0	1,5	4	40	M 2,5		1	1700 03 05090	1701 03 05090	1702 03 05090
6,0	1,5	5	45	M 3		1	1700 03 06090	1701 03 06090	1702 03 06090
6,3	1,5	5	45		M 3	1	1700 03 06390	1701 03 06390	1702 03 06390
7,0	1,8	6	50	M 3,5		1	1700 03 07090	1701 03 07090	1702 03 07090
7,3	1,8	6	50			1	1700 03 07390	1701 03 07390	1702 03 07390
8,0	2,0	6	50	M 4		1	1700 03 08090	1701 03 08090	1702 03 08090
8,3	2,0	6	50		M 4	1	1700 03 08390	1701 03 08390	1702 03 08390
9,4	2,2	6	50			1	1700 03 09490	1701 03 09490	1702 03 09490
10,0	2,5	6	50	M 5		1	1700 03 10090	1701 03 10090	1702 03 10090
10,4	2,5	6	50		M 5	1	1700 03 10490	1701 03 10490	1702 03 10490
11,5	2,8	8	56	M 6		1	1700 03 11590	1701 03 11590	1702 03 11590
12,0	2,8	8	56			1	1700 03 12090	1701 03 12090	1702 03 12090
12,4	2,8	8	56		M 6	1	1700 03 12490	1701 03 12490	1702 03 12490
15,0	3,2	10	60	M 8		1	1700 03 15090	1701 03 15090	1702 03 15090
16,5	3,2	10	60		M 8	1	1700 03 16590	1701 03 16590	1702 03 16590
19,0	3,5	10	63	M 10		1	1700 03 19090	1701 03 19090	1702 03 19090
20,5	3,5	10	63		M 10	1	1700 03 20590	1701 03 20590	1702 03 20590
23,0	3,8	10	67	M 12		1	1700 03 23090	1701 03 23090	1702 03 23090
25,0	3,8	10	67		M 12	1	1700 03 25090	1701 03 25090	1702 03 25090
28,0	4,0	12	71		M 14	1	1700 03 28090	1701 03 28090	1702 03 28090
31,0	4,2	12	71		M 16	1	1700 03 31090	1701 03 31090	1702 03 31090
40,0	4,2	13	80			1	1700 03 40090	-	-
50,0	4,5	15	92			1	1700 03 50090	-	-

BC ABS-Boxen / BC ABS-Boxes

Bezeichnung Description	Teile Pieces	Inhalt Content	Artikel-Nr. Part-No.
KS 5-K	5	Ø 6,3 · 10,4 · 16,5 · 20,5 · 25,0 mm	1700 13 30005
KS 6-K	6	Ø 6,3 · 8,3 · 10,4 · 12,4 · 16,5 · 20,5 mm	1700 13 30006
KS 6-K TiN	6	Ø 6,3 · 8,3 · 10,4 · 12,4 · 16,5 · 20,5 mm	1701 13 30006
KS 6-K TiAlN	6	Ø 6,3 · 8,3 · 10,4 · 12,4 · 16,5 · 20,5 mm	1702 13 30006



BC Industrie-Kassetten / BC Metal-Boxes

Bezeichnung Description	Teile Pieces	Inhalt Content	Artikel-Nr. Part-No.
KS 6	6	Ø 6,3 · 8,3 · 10,4 · 12,4 · 16,5 · 20,5 mm	1700 14 10006
KS 6 TiN	6	Ø 6,3 · 8,3 · 10,4 · 12,4 · 16,5 · 20,5 mm	1701 14 10006
KS 6 TiAlN	6	Ø 6,3 · 8,3 · 10,4 · 12,4 · 16,5 · 20,5 mm	1702 14 10006



Kegelsenker DIN 335 Form C 90° HSS-E (Co5) kobaltlegiert
Countersinks DIN 335 type C 90° HSS-E (Co5) cobalt alloyed



Code 1710



Code	P			M		K				N			S	
	1.1 - 2.1	3.1 - 4.1	5.1	1.1 - 2.1	3.1 - 4.1	1.1 - 1.2	2.1 - 2.2	3.1 - 3.2	4.1 - 4.2	1.1 - 1.5	2.1	2.2 - 2.3	4.1 - 4.2	1.1 - 1.2
1710	⊗	⊗	⊗	⊗		⊗	⊗		⊗	⊗	⊗	⊗	⊗	⊗

CBN-geschliffener Kegelsenker aus HSS-E zum grat- und ratterfreien Entgraten, Ansenken und Versenken. Kegelsenker mit höherer Warmhärtebeständigkeit geeignet für rost-, säure- und hitzebeständige Stähle.

CBN-ground countersink made of HSS-E for burr- and chatter-free deburring and countersinking. Countersink with higher heat resistance, suitable for stainless and heat-resistant steels.

Ø d2 mm	Ø d1 mm	Ø d3 mm	L 1 mm	DIN 74 BF		Artikel-Nr. Part-No.
6,3	1,5	5	45	M 3	1	1710 03 06390
8,3	2,0	6	50	M 4	1	1710 03 08390
10,4	2,5	6	50	M 5	1	1710 03 10490
12,4	2,8	8	56	M 6	1	1710 03 12490
16,5	3,2	10	60	M 8	1	1710 03 16590
20,5	3,5	10	63	M 10	1	1710 03 20590
25,0	3,8	10	67	M 12	1	1710 03 25090
31,0	4,2	12	71	M 16	1	1710 03 31090
40,0	4,2	13	80		1	1710 03 40090
50,0	4,5	15	92		1	1710 03 50090

BC ABS-Boxen / BC ABS-Boxes

Bezeichnung Description	Teile Pieces	Inhalt Content	Artikel-Nr. Part-No.
KS 5-K Co	5	Ø 6,3 · 10,4 · 16,5 · 20,5 · 25,0 mm	1710 13 30005
KS 6-K Co	6	Ø 6,3 · 8,3 · 10,4 · 12,4 · 16,5 · 20,5 mm	1710 13 30006

BC Industrie-Kassette / BC Metal-Box

Bezeichnung Description	Teile Pieces	Inhalt Content	Artikel-Nr. Part-No.
KS 6 Co	6	Ø 6,3 · 8,3 · 10,4 · 12,4 · 16,5 · 20,5 mm	1710 14 10006



KS 6-K Co



KS 6 Co

KEGELSENKER
COUNTERSINKS

Kegelsenker ~DIN 335 Form C 90° HSS, lange und extra lange Ausführung

Countersinks ~DIN 335 type C 90° HSS, long and extra long version

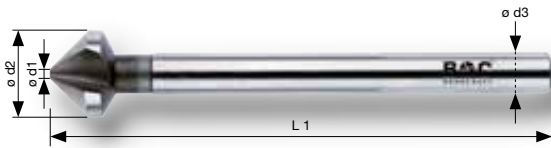
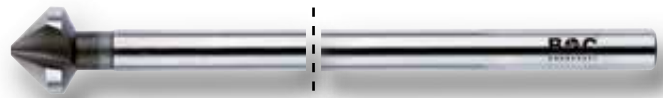
Code 1703-L

Code 1703-EL

Code	P			M		K				N				S
	1.1 - 2.1	3.1 - 4.1	5.1	1.1 - 2.1	3.1 - 4.1	1.1 - 1.2	2.1 - 2.2	3.1 - 3.2	4.1 - 4.2	1.1 - 1.5	2.1	2.2 - 2.3	4.1 - 4.2	1.1 - 1.2
1703														

CBN-geschliffener Kegelsenker mit langem oder extra langem Schaft. Zum grat- und ratterfreien Entgraten, Ansenken und Versenken an schwer zugänglichen Stellen oder Störkanten. Geeignet für normalharte Werkstoffe wie allgemeine Baustähle, NE-Metalle und Gusseisen.

CBN ground countersink with long or extra long shank. For burr and chatter-free deburring and countersinking in difficult accessible places or interfering edges. Suitable for normal hard materials such as general structural steels, non-ferrous metals and cast iron

Lange Ausführung / Long version

Ø d2 mm	Ø d1 mm	Ø d3 mm	L 1 mm	DIN 74 BF		Artikel-Nr. Part-No.
6,3	1,5	5	85	M 3	1	1703 03 06390
8,3	2,0	6	85	M 4	1	1703 03 08390
10,4	2,5	6	88	M 5	1	1703 03 10490
12,4	2,8	8	108	M 6	1	1703 03 12490
16,5	3,2	10	112	M 8	1	1703 03 16590
20,5	3,5	10	115	M 10	1	1703 03 20590

Extra-lange Ausführung / Extra-long version

Ø d2 mm	Ø d1 mm	Ø d3 mm	L 1 mm	DIN 74 BF		Artikel-Nr. Part-No.
6,3	1,5	5	154	M 3	1	1703 03 06391
8,3	2,0	6	155	M 4	1	1703 03 08391
10,4	2,5	6	157	M 5	1	1703 03 10491
12,4	2,8	8	158	M 6	1	1703 03 12491
16,5	3,2	10	161	M 8	1	1703 03 16591
20,5	3,5	10	164	M 10	1	1703 03 20591



Kegelsenker-Bits 90° HSS 1/4" Schaft Countersink-bits 90° HSS 1/4" hex-shank



Code 1705



Code	P			M		K				N			S	
	1.1 - 2.1	3.1 - 4.1	5.1	1.1 - 2.1	3.1 - 4.1	1.1 - 1.2	2.1 - 2.2	3.1 - 3.2	4.1 - 4.2	1.1 - 1.5	2.1	2.2 - 2.3	4.1 - 4.2	1.1 - 1.2
1705	☉					☉	☉		☉	☉	☉	☉	☉	

CBN-geschliffener Kegelsenker mit 1/4" Bit-Schaft. Zum grat- und ratterfreien Entgraten, Ansenken und Versenken in normalharten Werkstoffen wie allgemeinen Baustählen, NE-Metallen und Gusseisen.

CBN ground countersink with 1/4" hex. shank. For burr- and chatter-free deburring and countersinking in normal hard materials such as general structural steels, non-ferrous metals and cast iron.

Ø d2 mm	Ø d1 mm	Hexagon	L 1 mm	DIN 74 BF	Box	Artikel-Nr. Part-No.
6,3	1,5	1/4" / 6,35 mm	31	M 3	1	1705 03 06390
8,3	2,0	1/4" / 6,35 mm	31	M 4	1	1705 03 08390
10,4	2,5	1/4" / 6,35 mm	31	M 5	1	1705 03 10490
12,4	2,8	1/4" / 6,35 mm	35	M 6	1	1705 03 12490
16,5	3,2	1/4" / 6,35 mm	40	M 8	1	1705 03 16590
20,5	3,5	1/4" / 6,35 mm	41	M 10	1	1705 03 20590
25,0	3,8	1/4" / 6,35 mm	41	M 12	1	1705 03 25090

BC ABS-Box / BC ABS-Box

Bezeichnung Description	Teile Pieces	Inhalt Content	Artikel-Nr. Part-No.
KSB 6-K	8	Ø 6,3 · 8,3 · 10,4 · 12,4 · 16,5 · 20,5 mm + Bithalter und Handgriff · Bitholder and handle	1705 13 30006



Handentgrater 90° HSS Hand deburring tools 90° HSS



Ø d2 mm	Ø d1 mm	DIN 74 BF	Box	Artikel-Nr. Part-No.
10,4	2,5	M 5	1	1820 03 10490
12,4	2,8	M 6	1	1820 03 12490
16,5	3,2	M 8	1	1820 03 16590
20,5	3,5	M 10	1	1820 03 20590
25,0	3,8	M 12	1	1820 03 25090



Code 6300



Code 1820-H

Bezeichnung Description	Box	Artikel-Nr. Part-No.
BC-Handgriff / BC-Handle	1	1820 03 00001
Bithalter 60 mm / Bitholder 60 mm	1	6300 15 01060

Kegelsenker DIN 335 Form D 90° HSS, mit Morsekegelschaft Countersinks DIN 335 type D 90° HSS, with taper shank



Code 1704



Code	P			M		K				N				S
	1.1 - 2.1	3.1 - 4.1	5.1	1.1 - 2.1	3.1 - 4.1	1.1 - 1.2	2.1 - 2.2	3.1 - 3.2	4.1 - 4.2	1.1 - 1.5	2.1	2.2 - 2.3	4.1 - 4.2	1.1 - 1.2
1704	☉					☉	☉	☉	☉	☉	☉	☉	☉	☉

CBN-geschliffener Kegelsenker aus HSS zum grat- und ratterfreien Entgraten und Senken in normalharten Werkstoffen wie allgemeinen Baustählen, NE-Metallen und Gusseisen.

CBN-ground countersink made of HSS for burr- & chatterfree deburring and countersinking in normal hard materials such as general structural steels, non-ferrous metals and cast iron.

Ø d2 mm	Ø d1 mm	MK MT	L 1 mm	DIN 74 AF	DIN 74 BF		Artikel-Nr. Part-No.
15,0	3,2	1	85	M 8		1	1704 03 15090
16,5	3,2	1	85		M 8	1	1704 03 16590
19,0	3,5	2	100	M 10		1	1704 03 19090
20,5	3,5	2	100		M 10	1	1704 03 20590
23,0	3,8	2	106	M 12		1	1704 03 23090
25,0	3,8	2	106		M 12	1	1704 03 25090
26,0	3,8	2	106	M 14		1	1704 03 26090
28,0	4,0	2	112		M 14	1	1704 03 28090
30,0	4,2	2	112	M 16		1	1704 03 30090
31,0	4,2	2	112		M 16	1	1704 03 31090
34,0	4,5	2	118	M 18	M 18	1	1704 03 34090
37,0	4,8	2	118	M 20	M 20	1	1704 03 37090
40,0	10,0	3	140			1	1704 03 40090
50,0	14,0	3	150			1	1704 03 50090
63,0	16,0	4	180			1	1704 03 63090
80,0	22,0	4	190			1	1704 03 80090
100,0	28,0	4	200			1	1704 03 10090
120,0	34,0	4	208			1	1704 03 12090

Kegelsenker DIN 334 Form C 60° HSS Countersinks DIN 334 type C 60° HSS



Code 1700-60



Code	P			M		K				N				S
	1.1 - 2.1	3.1 - 4.1	5.1	1.1 - 2.1	3.1 - 4.1	1.1 - 1.2	2.1 - 2.2	3.1 - 3.2	4.1 - 4.2	1.1 - 1.5	2.1	2.2 - 2.3	4.1 - 4.2	1.1 - 1.2
1700-60	☉					☉	☉	☉	☉	☉	☉	☉	☉	☉

CBN-geschliffener Kegelsenker aus HSS zum grat- und ratterfreien Entgraten und Senken in normalharten Werkstoffen wie allgemeinen Baustählen, NE-Metallen und Gusseisen.

CBN-ground countersink made of HSS for burr- & chatterfree deburring and countersinking in normal hard materials such as general structural steels, non-ferrous metals and cast iron.

Ø d2 mm	Ø d1 mm	L 1 mm	Ø d3 mm		Artikel-Nr. Part-No.
6,3	1,6	45	5	1	1700 03 06360
8,3	2,0	50	6	1	1700 03 08060
10,0	2,5	50	6	1	1700 03 10060
12,5	3,2	56	8	1	1700 03 12560
16,0	4,0	63	10	1	1700 03 16060
20,0	5,0	67	10	1	1700 03 20060
25,0	6,3	71	10	1	1700 03 25060
30,0	7,1	71	12	1	1700 03 30060

Kegelsenker Form C 75° HSS Countersinks type C 75° HSS



Code 1700-75



Code	P			M		K				N				S
	1.1 - 2.1	3.1 - 4.1	5.1	1.1 - 2.1	3.1 - 4.1	1.1 - 1.2	2.1 - 2.2	3.1 - 3.2	4.1 - 4.2	1.1 - 1.5	2.1	2.2 - 2.3	4.1 - 4.2	1.1 - 1.2
1700-75	☉					☉	☉	☉	☉	☉	☉	☉	☉	☉

CBN-geschliffener Kegelsenker aus HSS zum grat- und ratterfreien Entgraten und Senken in normalharten Werkstoffen wie allgemeinen Baustählen, NE-Metallen und Gusseisen.

CBN-ground countersink made of HSS for burr- & chatterfree deburring and countersinking in normal hard materials such as general structural steels, non-ferrous metals and cast iron.

Ø d2 mm	Ø d1 mm	L 1 mm	Ø d3 mm		Artikel-Nr. Part-No.
6,3	1,6	45	5	1	1700 03 06375
8,3	2,0	50	6	1	1700 03 08375
10,4	2,5	50	6	1	1700 03 10475
12,4	3,2	56	8	1	1700 03 12475
16,5	4,0	63	10	1	1700 03 16575
20,5	5,0	67	10	1	1700 03 20575
25,0	6,3	71	10	1	1700 03 25075



KEGELSENKER
COUNTERSINKS

Kegelsenker Form C 120° HSS Countersinks type C 120° HSS

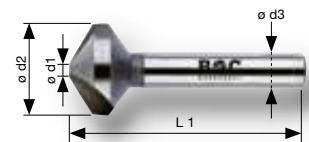

Code 1700-120

Code	P			M		K				N				S
	1.1 - 2.1	3.1 - 4.1	5.1	1.1 - 2.1	3.1 - 4.1	1.1 - 1.2	2.1 - 2.2	3.1 - 3.2	4.1 - 4.2	1.1 - 1.5	2.1	2.2 - 2.3	4.1 - 4.2	1.1 - 1.2
1700-120	☉					☉	☉	☉	☉	☉	☉	☉	☉	☉

CBN-geschliffener Kegelsenker aus HSS zum grat- und ratterfreien Entgraten und Senken in normalharten Werkstoffen wie allgemeinen Baustählen, NE-Metallen und Gusseisen.

CBN-ground countersink made of HSS for burr- & chatterfree deburring and countersinking in normal hard materials such as general structural steels, non-ferrous metals and cast iron.

Ø d2 mm	Ø d1 mm	L 1 mm	Ø d3 mm		Artikel-Nr. Part-No.
6,3	1,6	45	5	1	1700 03 06312
8,3	2,0	50	6	1	1700 03 08312
10,4	2,5	50	6	1	1700 03 10412
12,4	3,0	56	8	1	1700 03 12412
16,5	3,5	63	10	1	1700 03 16512
20,5	4,0	67	10	1	1700 03 20512
25,0	5,0	71	10	1	1700 03 25012

Kegel- und Entgratsenker HSS mit Querloch
Countersinks HSS with cross hole



Code 1720



Code 1721



Code	P			M		K				N				S
	1.1 - 2.1	3.1 - 4.1	5.1	1.1 - 2.1	3.1 - 4.1	1.1 - 1.2	2.1 - 2.2	3.1 - 3.2	4.1 - 4.2	1.1 - 1.5	2.1	2.2 - 2.3	4.1 - 4.2	1.1 - 1.2
1720														
1721														

Querlochsinker aus HSS mit einer Schneide. Die Späne werden durch die Bohrung in Schafrichtung abgeführt. Zum grat- und ratterfreien Entgraten, Ansenken und Versenken in gut zerspanbaren Werkstoffen wie allgemeinen Baustählen, NE-Metallen und Gusseisen. Geringe Schnittgeschwindigkeit sorgt für optimale Ergebnisse.

Cross hole countersink made of HSS with one cutting edge. The chips are removed through the hole in the direction of the shank. For burr and chatter-free deburring and countersinking in good machinable materials such as general structural steels, non-ferrous metals and cast iron. Low cutting speed ensures the best results.

Größe Size	Ø d1 mm	Ø d2 mm	L 1 mm		TiN	
					Artikel-Nr. Part-No.	Artikel-Nr. Part-No.
1	2 - 5	6	45	1	1720 03 00001	1721 03 00001
2	5 - 10	8	48	1	1720 03 00002	1721 03 00002
3	10 - 15	10	65	1	1720 03 00003	1721 03 00003
4	15 - 20	12	85	1	1720 03 00004	1721 03 00004
5	20 - 25	12	102	1	1720 03 00005	1721 03 00005
6	25 - 30	15	115	1	1720 03 00006	-

BC ABS-Box / BC ABS-Box

Bezeichnung Description	Teile Pieces	Inhalt Content	Artikel-Nr. Part-No.
QS 4-K	4	Größe / Size: 1 · 2 · 3 · 4 Bereich / Range: Ø 2-5 · 5-10 · 10-15 · 15-20 mm	1720 13 30004



QS 4-K

QUERLOCHSENKER
CROSS HOLE COUNTERSINKS

Flachsenker DIN 373 HSS mit festem Führungszapfen Flat countersinks DIN 373 HSS with fixed guide



Code 1706 • 1707 • 1708



Code 1716 • 1717 • 1718



Code	P			M		K				N			S	
	1.1 - 2.1	3.1 - 4.1	5.1	1.1 - 2.1	3.1 - 4.1	1.1 - 1.2	2.1 - 2.2	3.1 - 3.2	4.1 - 4.2	1.1 - 1.5	2.1	2.2 - 2.3	4.1 - 4.2	1.1 - 1.2
1706 - 1708	⊕	⊕				⊕	⊕			⊕	⊕	⊕	⊕	⊕
1716 - 1718	⊕	⊕		⊕		⊕	⊕		⊕	⊕	⊕	⊕	⊕	⊕

Flachsenker zur Herstellung von Senkungen für Zylinderkopfschrauben, Sechskantschrauben und Muttern in gut zerspanbaren Werkstoffen wie allgemeinen Baustählen, NE-Metallen und Gusseisen. Geringe Schnittgeschwindigkeit sorgt für optimale Ergebnisse.

Für Senkungen nach DIN 74, Blatt 2, Form H - J - K.

Flat countersinks for producing countersinkings for cylinder-head screws, thread-cutting screws and thread-furrowing screws in good machinable materials such as general structural steels, non-ferrous metals and cast iron. Low cutting speed ensures the best results.

For countersinkings according to DIN 74, Sheet 2, form H - J - K.

M	Ø d2 mm	Ø d1 mm	Ø d3 mm	L 1 mm		TiN	
						Artikel-Nr. Part-No.	Artikel-Nr. Part-No.
Gütegrad fein für Durchgangsloch / Fine grade for through hole							
M 3	6	3,2	5,0	71	1	1706 03 00300	1716 03 00300
M 4	8	4,3	5,0	71	1	1706 03 00400	1716 03 00400
M 5	10	5,3	8,0	80	1	1706 03 00500	1716 03 00500
M 6	11	6,4	8,0	80	1	1706 03 00600	1716 03 00600
M 8	15	8,4	12,5	100	1	1706 03 00800	1716 03 00800
M 10	18	10,5	12,5	100	1	1706 03 01000	1716 03 01000
M 12	20	13,0	12,5	100	1	1706 03 01200	1716 03 01200
Gütegrad mittel für Durchgangsloch / Medium grade for through hole							
M 3	6	3,4	5,0	71	1	1707 03 00300	1717 03 00300
M 4	8	4,5	5,0	71	1	1707 03 00400	1717 03 00400
M 5	10	5,5	8,0	80	1	1707 03 00500	1717 03 00500
M 6	11	6,6	8,0	80	1	1707 03 00600	1717 03 00600
M 8	15	9,0	12,5	100	1	1707 03 00800	1717 03 00800
M 10	18	11,0	12,5	100	1	1707 03 01000	1717 03 01000
M 12	20	13,5	12,5	100	1	1707 03 01200	1717 03 01200
Für Gewindekernloch / For thread core hole							
M 3	6	2,5	5,0	71	1	1708 03 00300	1718 03 00300
M 4	8	3,3	5,0	71	1	1708 03 00400	1718 03 00400
M 5	10	4,2	8,0	80	1	1708 03 00500	1718 03 00500
M 6	11	5,0	8,0	80	1	1708 03 00600	1718 03 00600
M 8	15	6,8	12,5	100	1	1708 03 00800	1718 03 00800
M 10	18	8,5	12,5	100	1	1708 03 01000	1718 03 01000
M 12	20	10,2	12,5	100	1	1708 03 01200	1718 03 01200

BC ABS-Boxen / BC ABS-Boxes

Bezeichnung Description	Teile Pieces	Inhalt Content	Artikel-Nr. Part-No.
FS 6-FK	6 M3 - M10	Gütegrad fein / Fine grade M3 · M4 · M5 · M6 · M8 · M10	1706 13 30006
FS 6-MK	6 M3 - M10	Gütegrad mittel / Medium grade M3 · M4 · M5 · M6 · M8 · M10	1707 13 30006
FS 6-KK	6 M3 - M10	Gewindekernloch / Thread core hole M3 · M4 · M5 · M6 · M8 · M10	1708 13 30006



FLACHSENKER
FLAT COUNTERSINKS

Mehrfasenstufenbohrer DIN 8374 / 8376 HSS-G

Subland drills DIN 8374 / 8376 HSS-G

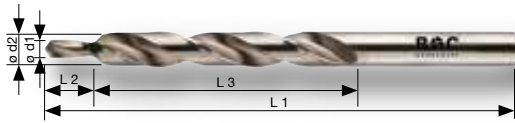

Code 1625



Code 1626



Code	P			M		K				N				S
	1.1 - 2.1	3.1 - 4.1	5.1	1.1 - 2.1	3.1 - 4.1	1.1 - 1.2	2.1 - 2.2	3.1 - 3.2	4.1 - 4.2	1.1 - 1.5	2.1	2.2 - 2.3	4.1 - 4.2	1.1 - 1.2
1625 - 1626	☉					☉	☉	☉	☉	☉	☉	☉	☉	☉

Mehrfasenstufenbohrer aus HSS zum Herstellen von exakten, zylindrischen Durchgangsbohrungen und Schraubenkopfsenkungen.

Subland drill made of HSS for producing precise, cylindrical through holes and screw head counterborings.

90° Gütegrad fein für Durchgangsloch / 90° Fine grade for through hole

M	Ø d1 mm	Ø d2 mm	L 2 mm	L 3 mm	L 1 mm		Artikel-Nr. Part-No.
M 3	3,2	6,0	9	57	93	1	1625 03 00300
M 4	4,3	8,0	11	75	117	1	1625 03 00400
M 5	5,3	10,0	13	87	133	1	1625 03 00500
M 6	6,4	11,5	15	94	142	1	1625 03 00600
M 8	8,4	15,0	19	114	169	1	1625 03 00800
M 10	10,5	19,0	23	135	191	1	1625 03 01000

180° Gütegrad mittel für Durchgangsloch / 180° Medium grade for through hole

M	Ø d1 mm	Ø d2 mm	L 2 mm	L 3 mm	L 1 mm		Artikel-Nr. Part-No.
M 3	3,4	6,0	9	57	93	1	1626 03 00300
M 4	4,5	8,0	11	75	117	1	1626 03 00400
M 5	5,5	10,0	13	87	133	1	1626 03 00500
M 6	6,6	11,0	15	94	142	1	1626 03 00600
M 8	9,0	15,0	19	114	169	1	1626 03 00800
M 10	11,0	18,0	23	135	191	1	1626 03 01000

Größe Size	Beschreibung Description									
1A	Für metrische Lochmaße / For metric hole diameters Ø 4,0 mm Ø 6,0 mm Ø 8,0 mm Ø 10,0 mm Ø 12,0 mm									
2A	Für metrische Lochmaße / For metric hole diameters Ø 4,0 mm Ø 6,0 mm Ø 8,0 mm Ø 10,0 mm Ø 12,0 mm Ø 14,0 mm Ø 16,0 mm Ø 18,0 mm Ø 20,0 mm									
3A	Für metrische Lochmaße / For metric hole diameters Ø 4,0 mm Ø 6,0 mm Ø 8,0 mm Ø 10,0 mm Ø 12,0 mm Ø 14,0 mm Ø 16,0 mm Ø 18,0 mm Ø 20,0 mm Ø 22,0 mm Ø 24,0 mm Ø 26,0 mm Ø 28,0 mm Ø 30,0 mm									
1	Für metrische Lochmaße / For metric hole diameters Ø 4,0 mm Ø 5,0 mm Ø 6,0 mm Ø 7,0 mm Ø 8,0 mm Ø 9,0 mm Ø 10,0 mm Ø 11,0 mm Ø 12,0 mm									
2	Für metrische Lochmaße / For metric hole diameters Ø 12,0 mm Ø 13,0 mm Ø 14,0 mm Ø 15,0 mm Ø 16,0 mm Ø 17,0 mm Ø 18,0 mm Ø 19,0 mm Ø 20,0 mm									
3	Für metrische Lochmaße / For metric hole diameters Ø 20,0 mm Ø 21,0 mm Ø 22,0 mm Ø 23,0 mm Ø 24,0 mm Ø 25,0 mm Ø 26,0 mm Ø 27,0 mm Ø 28,0 mm Ø 29,0 mm Ø 30,0 mm									
4	Für Panzerrohrgewinde Kernlochmaße / For steel conduit threads (core holes) PG 7 PG 9 PG 11 PG 13,5 PG 16 PG 21 Ø 11,4 mm Ø 14,0 mm Ø 17,25 mm Ø 19,0 mm Ø 21,25 mm Ø 26,75 mm									
5	Für Panzerrohrgewinde Durchgangsmaße / For steel conduit threads (through holes) PG 7 PG 9 PG 11 PG 13,5 PG 16 PG 21 PG 29 Ø 12,5 mm Ø 15,2 mm Ø 18,6 mm Ø 20,4 mm Ø 22,5 mm Ø 28,3 mm Ø 37,0 mm									
6	Für metrische Lochmaße / For metric hole diameters Ø 4,0 mm Ø 6,0 mm Ø 9,0 mm Ø 12,0 mm Ø 15,0 mm Ø 18,0 mm Ø 21,0 mm Ø 24,0 mm Ø 27,0 mm Ø 30,0 mm Ø 33,0 mm Ø 36,0 mm Ø 39,0 mm									
7	Für metrische Lochmaße / For metric hole diameters Ø 6,0 mm Ø 9,0 mm Ø 13,0 mm Ø 16,0 mm Ø 19,0 mm Ø 21,0 mm Ø 23,0 mm Ø 26,0 mm Ø 29,0 mm Ø 32,0 mm Ø 35,0 mm Ø 38,0 mm									
9	Für metrische Kabelverschraubungen, Kernlochmaße nach / For metric cable connections, core holes according DIN/EN 60423 M 6 M 8 M 10 M 12 M 16 M 20 M 25 M 32 Ø 5,3 mm Ø 7,0 mm Ø 9,0 mm Ø 10,5 mm Ø 14,5 mm Ø 18,5 mm Ø 23,5 mm Ø 30,5 mm									
10	Für metrische Kabelverschraubungen, Kernlochmaße nach / For metric cable connections, core holes according DIN/EN 60423 M 6 M 8 M 10 M 12 M 16 M 20 M 25 M 32 M 40 Ø 5,3 mm Ø 7,0 mm Ø 9,0 mm Ø 10,5 mm Ø 14,5 mm Ø 18,5 mm Ø 23,5 mm Ø 30,5 mm Ø 38,5 mm									
11	Für metrische Kabelverschraubungen, Durchgangsmaße nach DIN/EN 50262 For metric cable connections, through holes according DIN/EN 50262 M 6 M 8 M 10 M 12 M 16 M 20 M 25 Ø 30,5 mm Ø 6,5 mm Ø 8,5 mm Ø 10,5 mm Ø 12,5 mm Ø 16,5 mm Ø 20,5 mm Ø 25,5 mm Ø 32,5 mm									
12	Für metrische Kabelverschraubungen, Durchgangsmaße nach DIN/EN 50262 For metric cable connections, through holes according DIN/EN 50262 M 6 M 8 M 10 M 12 M 16 M 20 M 25 M 32 M 40 Ø 6,5 mm Ø 8,5 mm Ø 10,5 mm Ø 12,5 mm Ø 16,5 mm Ø 20,5 mm Ø 25,5 mm Ø 32,5 mm Ø 40,5 mm									

Größe Size	Bereich Range mm	Stufen Steps	Übersicht / Overview													
			1	2	3	4	5	6	7	8	9	10	11	12	13	14
1	4 – 12	9	4,0	5,0	6,0	7,0	8,0	9,0	10,0	11,0	12,0	-	-	-	-	-
2	12 – 20	9	12,0	13,0	14,0	15,0	16,0	17,0	18,0	19,0	20,0	-	-	-	-	-
3	20 – 30	11	20,0	21,0	22,0	23,0	24,0	25,0	26,0	27,0	28,0	29,0	30,0	-	-	-
1A	4 – 12	5	4,0	6,0	8,0	10,0	12,0	-	-	-	-	-	-	-	-	-
2A	4 – 20	9	4,0	6,0	8,0	10,0	12,0	14,0	16,0	18,0	20,0	-	-	-	-	-
3A	4 – 30	14	4,0	6,0	8,0	10,0	12,0	14,0	16,0	18,0	20,0	22,0	24,0	26,0	28,0	30,0
4	6 – 26,75	8	6,0	9,0	11,4	14,0	17,25	19,0	21,25	26,75	-	-	-	-	-	-
5	6 – 37	12	6,0	9,0	12,5	15,2	18,6	20,4	22,5	26,0	28,3	30,5	34,0	37,0	-	-
6	4 – 39	13	4,0	6,0	9,0	12,0	15,0	18,0	21,0	24,0	27,0	30,0	33,0	36,0	39,0	-
7	6 – 38	12	6,0	9,0	13,0	16,0	19,0	21,0	23,0	26,0	29,0	32,0	35,0	38,0	-	-
9	5,3 – 30,5	9	5,3	7,0	9,0	10,5	14,5	18,5	23,5	27,0	30,5	-	-	-	-	-
10	5,3 – 38,5	11	5,3	7,0	9,0	10,5	14,5	18,5	23,5	27,0	30,5	34,5	38,5	-	-	-
11	6,5 – 32,5	9	6,5	8,5	10,5	12,5	16,5	20,5	25,5	29,0	32,5	-	-	-	-	-
12	6,5 – 40,5	11	6,5	8,5	10,5	12,5	16,5	20,5	25,5	29,0	32,5	36,5	40,5	-	-	-



Stufenbohrer HSS mit Spiralnut

Step drills HSS with spiral flute

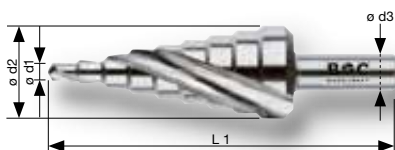

Code 1763



Code 1764



Code 1767



Code	P			M		K				N				S
	1.1 - 2.1	3.1 - 4.1	5.1	1.1 - 2.1	3.1 - 4.1	1.1 - 1.2	2.1 - 2.2	3.1 - 3.2	4.1 - 4.2	1.1 - 1.5	2.1	2.2 - 2.3	4.1 - 4.2	1.1 - 1.2
1763	⊗					⊗	⊗		⊗	⊗	⊗	⊗	⊗	⊗
1764	⊗	⊗		⊗		⊗	⊗		⊗	⊗	⊗	⊗	⊗	⊗
1767	⊗	⊗	⊗	⊗		⊗	⊗		⊗	⊗	⊗	⊗	⊗	⊗

Premium Stufenbohrer mit Spiralnut. Die CBN-geschliffene spiralförmige Spanntut sorgt für einen ruhigen Lauf und saubere, gratfreie Bohrungen. Die entstehenden Späne werden zuverlässig entgegen der Schneidrichtung abtransportiert. Für normalharte Werkstoffe wie allgemeine Baustähle, NE-Metalle und Kunststoff. Maximale Materialstärke = Stufenhöhe.

Premium step drill with spiral flute. The CBN-ground spiral flute ensures smooth running and clean, burr-free holes. The produced chips are reliably evacuated in the opposite direction to the cutting direction. For normal hard materials such as general structural steels, non-ferrous metals and plastic. Maximum material thickness = step height.

Größe Size	Ø d1 - d2 mm	Stufen Steps	Ø d3 mm	L 1 mm		TiN		blue+
						Artikel-Nr. Part-No.	Artikel-Nr. Part-No.	Artikel-Nr. Part-No.
1-S	4 - 12	9	6	65	1	1763 03 00001	1764 03 00001	1767 03 00001
1A-S	4 - 12	5	6	65	1	1763 03 00011	1764 03 00011	1767 03 00011
2A-S	4 - 20	9	8	75	1	1763 03 00022	1764 03 00022	1767 03 00022
3A-S	4 - 30	14	10	100	1	1763 03 00033	1764 03 00033	1767 03 00033
4-S	6 - 26,75	8	10	75	1	1763 03 00044	1764 03 00044	1767 03 00044
5-S	6 - 37	12	10	100	1	1763 03 00055	1764 03 00055	1767 03 00055
6-S	4 - 39	13	10	107	1	1763 03 00066	1764 03 00066	1767 03 00066
7-S	6 - 38	12	10	100	1	1763 03 00077	1764 03 00077	1767 03 00077
11-S	6,5 - 32,5	9	10	79	1	1763 03 01111	1764 03 01111	1767 03 01111
12-S	6,5 - 40,5	11	10	96	1	1763 03 01212	1764 03 01212	1767 03 01212

BC ABS-Box / BC ABS-Box

Bezeichnung Description	Teile Pieces	Inhalt Content	Artikel-Nr. Part-No.
STB 3-KS	3	Größe / Size: 1 · 2A · 3A Bereich / Range: Ø 4-12 · 4-20 · 4-30 mm	1763 13 30003
STB 3-KS TiN	3	Größe / Size: 1 · 2A · 3A Bereich / Range: Ø 4-12 · 4-20 · 4-30 mm	1764 13 30003
STB 3-KS B+	3	Größe / Size: 1 · 2A · 3A Bereich / Range: Ø 4-12 · 4-20 · 4-30 mm	1767 13 30003



STB 3-KS



STB 3-KS TiN



STB 3-KS B+

STUFENBOHRER
STEP DRILLS

Stufenbohrer HSS-E (Co5) kobaltlegiert, mit Spiralnut Step drills HSS-E (Co5) cobalt alloyed, with spiral flute

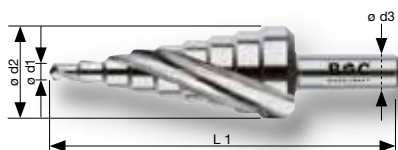

Code 1765



Code 1766



Code	P			M		K				N			S	
	1.1 - 2.1	3.1 - 4.1	5.1	1.1 - 2.1	3.1 - 4.1	1.1 - 1.2	2.1 - 2.2	3.1 - 3.2	4.1 - 4.2	1.1 - 1.5	2.1	2.2 - 2.3	4.1 - 4.2	1.1 - 1.2
1765	•	•	•	•	•	•	•	•	•	•	•	•	•	•
1766	•	•	•	•	•	•	•	•	•	•	•	•	•	•

Premium Stufenbohrer aus HSS-E mit höherer Warmhärtebeständigkeit, geeignet für rost-, säure- und hitzebeständige Stähle. Die CBN-geschliffene spiralförmige Spanntung sorgt für einen ruhigen Lauf und saubere, gratfreie Bohrungen. Die entstehenden Späne werden zuverlässig entgegen der Schneidrichtung abtransportiert. Maximale Materialstärke = Stufenhöhe.

Premium step drill made of HSS-E with higher heat resistance, suitable for stainless and heat-resistant steels. The CBN-ground spiral flute ensures smooth running and clean, burr-free holes. The produced chips are reliably evacuated in the opposite direction to the cutting direction. Maximum material thickness = step height.

Größe Size	Ø d1 – d2 mm	Stufen Steps	Ø d3 mm	L 1 mm		blue+	
						Artikel-Nr. Part-No.	Artikel-Nr. Part-No.
1-S	4 – 12	9	6	65	1	1765 03 00001	1766 03 00001
2A-S	4 – 20	9	8	75	1	1765 03 00022	1766 03 00022
3A-S	4 – 30	14	10	100	1	1765 03 00033	1766 03 00033
5-S	6 – 37	12	10	100	1	1765 03 00055	1766 03 00055
6-S	4 – 39	13	10	107	1	1765 03 00066	1766 03 00066

BC ABS-Box / BC ABS-Box

Bezeichnung Description	Teile Pieces	Inhalt Content	Artikel-Nr. Part-No.
STB 3 KS-Co	3	Größe / Size: 1 · 2A · 3A Bereich / Range: Ø 4-12 · 4-20 · 4-30 mm	1765 13 30003
STB 3 KS-Co B+	3	Größe / Size: 1 · 2A · 3A Bereich / Range: Ø 4-12 · 4-20 · 4-30 mm	1766 13 30003



STB 3 KS-Co



STB 3 KS-Co B+



STUFENBOHRER
STEP DRILLS

Stufenbohrer HSS

Step drills HSS

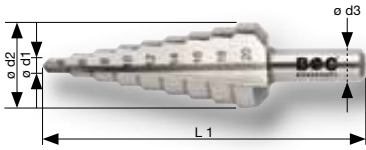

Code 1760



Code 1761



Code 1762



Code	P			M		K				N				S
	1.1 - 2.1	3.1 - 4.1	5.1	1.1 - 2.1	3.1 - 4.1	1.1 - 1.2	2.1 - 2.2	3.1 - 3.2	4.1 - 4.2	1.1 - 1.5	2.1	2.2 - 2.3	4.1 - 4.2	1.1 - 1.2
1760	⊗					⊗	⊗		⊗	⊗				
1761	⊗	⊗		⊗		⊗	⊗		⊗	⊗	⊗		⊗	⊗
1762	⊗	⊗	⊗	⊗		⊗	⊗		⊗	⊗	⊗	⊗	⊗	⊗

CBN-geschliffener Stufenbohrer aus HSS. Der 3-Flächenschaft sorgt für optimale Kraftübertragung und verhindert ein Durchrutschen im Bohrfutter. Für gratfreie Bohrungen in normalharten Werkstoffen wie allgemeinen Baustählen, NE-Metallen und Kunststoff.

Maximale Materialstärke = Stufenhöhe.

CBN ground step drill made of HSS. The triangle shank ensures optimal power transmission and prevents slipping in the drill chuck. For burr-free drilling in normal-hard materials such as general structural steels, non-ferrous metals and plastic.

Maximum material thickness = step height.

Größe Size	Ø d1 - d2 mm	Stufen Steps	Ø d3 mm	L 1 mm		TiN		TiAlN
						Artikel-Nr. Part-No.	Artikel-Nr. Part-No.	Artikel-Nr. Part-No.
1	4 - 12	9	6	65	1	1760 03 00001	1761 03 00001	1762 03 00001
2	12 - 20	9	8	66	1	1760 03 00002	1761 03 00002	1762 03 00002
3	20 - 30	11	10	82	1	1760 03 00003	1761 03 00003	1762 03 00003
1A	4 - 12	5	6	65	1	1760 03 00011	1761 03 00011	1762 03 00011
2A	4 - 20	9	8	75	1	1760 03 00022	1761 03 00022	1762 03 00022
3A	4 - 30	14	10	100	1	1760 03 00033	1761 03 00033	1762 03 00033
4	6 - 26,75	8	10	75	1	1760 03 00044	-	-
5	6 - 37	12	10	100	1	1760 03 00055	1761 03 00055	1762 03 00055
6	4 - 39	13	10	107	1	1760 03 00066	1761 03 00066	1762 03 00066
9	5,3 - 30,5	9	10	79	1	1760 03 00099	-	-
10	5,3 - 38,5	11	10	96	1	1760 03 01010	-	-
11	6,5 - 32,5	9	10	79	1	1760 03 01111	-	-
12	6,5 - 40,5	11	10	96	1	1760 03 01212	-	-

BC ABS-Boxen / BC ABS-Boxes

Bezeichnung Description	Teile Pieces	Inhalt Content	Artikel-Nr. Part-No.
STB 3-K	3	Größe / Size: 1 · 2A · 3A Bereich / Range: Ø 4-12 · 4-20 · 4-30 mm	1760 13 30003
STB 3-K TiN	3	Größe / Size: 1 · 2A · 3A Bereich / Range: Ø 4-12 · 4-20 · 4-30 mm	1761 13 30003
STB 3-K TiAlN	3	Größe / Size: 1 · 2A · 3A Bereich / Range: Ø 4-12 · 4-20 · 4-30 mm	1762 13 30003



BC Industrie-Kassetten / BC Metal-Boxes

Bezeichnung Description	Teile Pieces	Inhalt Content	Artikel-Nr. Part-No.
STB 3	3	Größe / Size: 1 · 2A · 3A Bereich / Range: Ø 4-12 · 4-20 · 4-30 mm	1760 14 10003
STB 3 TiN	3	Größe / Size: 1 · 2A · 3A Bereich / Range: Ø 4-12 · 4-20 · 4-30 mm	1761 14 10003



Stufenbohrer HSS 1/4" Schaft
Step drills HSS 1/4" hex-shank

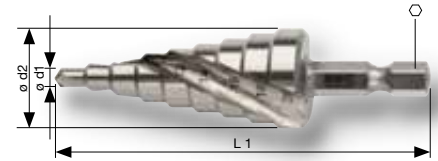

Code 1760-1/4"



Code	P			M		K				N				S
	1.1 - 2.1	3.1 - 4.1	5.1	1.1 - 2.1	3.1 - 4.1	1.1 - 1.2	2.1 - 2.2	3.1 - 3.2	4.1 - 4.2	1.1 - 1.5	2.1	2.2 - 2.3	4.1 - 4.2	1.1 - 1.2
1760-1/4"	☉					☉	☉	☉	☉	☉	☉	☉	☉	☉

CBN-geschliffener Stufenbohrer aus HSS mit 1/4" Bit-Schaft.
Für gratfreie Bohrungen in normalharten Werkstoffen wie
allgemeinen Baustählen, NE-Metallen und Kunststoff.
Maximale Materialstärke = Stufenhöhe.

CBN-ground step drill made of HSS with 1/4" hex. shank. For
burr-free drilling in normal hard materials such as general
structural steels, non-ferrous metals and plastic.
Maximum material thickness = step height.

Größe Size	Ø d1 - d2 mm	Stufen Steps	Hexagon	L 1 mm	Icon	Artikel-Nr. Part-No.
1	4 - 12	9	1/4" / 6,35 mm	68	1	1760 03 10001
2A	4 - 20	9	1/4" / 6,35 mm	78	1	1760 03 10022
3A	4 - 30	14	1/4" / 6,35 mm	103	1	1760 03 10033



STUFENBOHRER
STEP DRILLS

Blechsälbohrer HSS
Sheet metal drills HSS

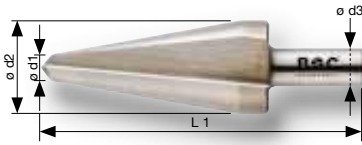

Code 1740



Code 1741



Code 1742



Code	P			M		K				N				S
	1.1 - 2.1	3.1 - 4.1	5.1	1.1 - 2.1	3.1 - 4.1	1.1 - 1.2	2.1 - 2.2	3.1 - 3.2	4.1 - 4.2	1.1 - 1.5	2.1	2.2 - 2.3	4.1 - 4.2	1.1 - 1.2
1740														
1741														
1742														

CBN-geschliffener Blechsälbohrer aus HSS zum stufenlosen Bohren und Aufbohren von dünnwandigen Materialien. Selbstzentrierend durch Kreuzanschliff nach DIN 1412 C. Der 3-Flächenschaft sorgt für optimale Kraftübertragung und verhindert ein Durchrutschen im Bohrfutter. Für gratfreie Bohrungen in normalharten Werkstoffen wie allgemeinen Baustählen, NE-Metallen und Kunststoff. Maximale Materialstärke = 4 mm.

CBN-ground sheet metal drill made of HSS for stepless drilling and drilling of thin-walled materials. Self-centering due to the split point according to DIN 1412 C. The triangle shank ensures optimal power transmission and prevents slipping in the drill chuck. For burr-free drilling in normal hard materials such as general structural steels, non-ferrous metals and plastic. Maximum material thickness = 4 mm.

Größe Size	$\varnothing d_1 - d_2$ mm	$\varnothing d_3$ mm	L 1 mm		TiN		TiALN
					Artikel-Nr. Part-No.	Artikel-Nr. Part-No.	Artikel-Nr. Part-No.
1	3 - 14	6	58	1	1740 03 00001	1741 03 00001	1742 03 00001
2	6 - 20	8	70	1	1740 03 00002	1741 03 00002	1742 03 00002
3	16 - 30,5	9	76	1	1740 03 00003	1741 03 00003	1742 03 00003
4	26 - 40	10	87	1	1740 03 00004	1741 03 00004	1742 03 00004
5	36 - 50	12	97	1	1740 03 00005	1741 03 00005	1742 03 00005
L	6 - 30	10	90	1	1740 03 00007	1741 03 00007	1742 03 00007

BC ABS-Boxen / BC ABS-Boxes

Bezeichnung Description	Teile Pieces	Inhalt Content	Artikel-Nr. Part-No.
B 3-K	3	Größe / Size: 1 · 2 · 3	1740 13 30003
B 3-K TiN	3	Größe / Size: 1 · 2 · 3	1741 13 30003
B 3-K TiALN	3	Größe / Size: 1 · 2 · 3	1742 13 30003

BC Industrie-Kassetten / BC Metal-Boxes

Bezeichnung Description	Teile Pieces	Inhalt Content	Artikel-Nr. Part-No.
B 3	3	Größe / Size: 1 · 2 · 3	1740 14 10003
B 3 TiN	3	Größe / Size: 1 · 2 · 3	1741 14 10003



B 3-K



B 3-K TiALN



B 3



B 3 TiN

Blechsälbohrer HSS-E (Co5) kobaltlegiert

Sheet metal drills HSS-E (Co5) cobalt alloyed

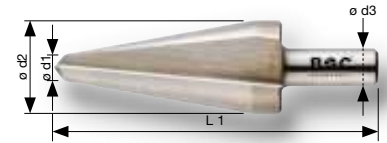

Code 1743



Code	P			M		K				N				S
	1.1 - 2.1	3.1 - 4.1	5.1	1.1 - 2.1	3.1 - 4.1	1.1 - 1.2	2.1 - 2.2	3.1 - 3.2	4.1 - 4.2	1.1 - 1.5	2.1	2.2 - 2.3	4.1 - 4.2	1.1 - 1.2
1743	☉	☉	☉	☉		☉	☉		☉	☉	☉	☉	☉	☉

CBN-geschliffener Blechsälbohrer aus HSS-E mit höherer Warmhärtebeständigkeit, geeignet für rost- säure- und hitzebeständige Stähle. Zum stufenlosen Bohren und Aufbohren von dünnwandigen Materialien. Selbstzentrierend durch Kreuzanschliff nach DIN 1412 C. Der 3-Flächenschaft sorgt für optimale Kraftübertragung und verhindert ein Durchrutschen im Bohrfutter. Maximale Materialstärke = 4 mm.

CBN-ground sheet metal drill made of HSS-E with higher heat resistance, suitable for stainless and heat-resistant steels. For stepless drilling and drilling of thin-walled materials. Self-centering due to the split point according to DIN 1412 C. The triangle shank ensures optimal power transmission and prevents slipping in the drill chuck. Maximum material thickness = 4 mm.

Größe Size	Ø d1 – d2 mm	Ø d3 mm	L 1 mm		Artikel-Nr. Part-No.
1	3 – 14	6	58	1	1743 03 00001
2	6 – 20	8	70	1	1743 03 00002
3	16 – 30,5	9	76	1	1743 03 00003

BC ABS-Box / BC ABS-Box

Bezeichnung Description	Teile Pieces	Inhalt Content	Artikel-Nr. Part-No.
B 3-K Co	3	Größe / Size: 1 · 2 · 3	1743 13 30003



Blechsälbohrer HSS mit Anschlag

Sheet metal drills HSS with backstop



Code 1740-A



Code 1741-A



Code	P			M		K				N				S
	1.1 - 2.1	3.1 - 4.1	5.1	1.1 - 2.1	3.1 - 4.1	1.1 - 1.2	2.1 - 2.2	3.1 - 3.2	4.1 - 4.2	1.1 - 1.5	2.1	2.2 - 2.3	4.1 - 4.2	1.1 - 1.2
1740	☉					☉	☉		☉	☉	☉	☉	☉	☉
1741	☉	☉		☉		☉	☉		☉	☉	☉	☉	☉	☉













CBN-geschliffener Blechsälbohrer aus HSS mit Anschlag.

CBN-ground sheet metal drill made of HSS with backstop.

Größe Size	Ø d1 – d2 mm	Ø d3 mm	L 1 mm		TIN	
					Artikel-Nr. Part-No.	Artikel-Nr. Part-No.
1A	2,5 – 7,8	6	48	1	1740 03 00011	-
2A	2,5 – 10,2	6	53	1	1740 03 00022	-
3A	2,5 – 11,8	6	57	1	1740 03 00033	-
4A	3 – 15	6	68	1	1740 03 00044	1741 03 00044

ENTGRATER
DEBURRING TOOLS



	Qualität Quality	Typ Type	Bezeichnung Description	Code	Seite Page
Entgrater / Deburring tools					
			Handgriffe Handles	1650	286
			Klingenhalter Holders	1651	286
	HSS	BC-B	Entgrater-Klingen Deburring blades	1659	287
	HSS	BC-E	Entgrater-Klingen Deburring blades	1660	287
	HSS	BC1 BC2	Schnellentgrater Rapid deburrers	1653 1654	288
	HSS	BC-DS3 BC-DS8	Dreikantschaber Triangular scrapers	1656	288
	HSS	BC-C42	Ersatzklinge für BC-DS8 Spare blade for type BC-DS8	1661	288
	HSS	BC-HE1 BC-HE3 BC-HTB4	Handgriffe mit HSS-Klingen Handles with HSS-blades	1652	289
	HSS	BC-DE	Doppelentgrater mit HSS-Schneidscheiben Double deburrer with round HSS-blades	1655	290
	HSS	BC-R12	Ersatzschneidscheibe für Doppelentgrater BC-DE Spare round blade for double deburrer BC-DE	1655	290
Außen-Entgrater / Outer-deburring tools					
	HSS		Entgrater EGR Deburrers EGR	1648	291
	HM		Entgrater EGR HM+ Deburrers EGR HM+	1648	291

Entgrater Deburring tools

B

E

Handgriffe Handles

Typ Type	Passend für Suitable for			Artikel-Nr. Part-No.
BC-HK	Klingenhalter / Blade-holders BC-TKB BC-TKE		1	1650 03 00001
BC-HE	Klingen / Blades BC-E		1	1650 03 00002

B

E

Klingenhalter Holders

Typ Type	Passend für Suitable for			Artikel-Nr. Part-No.
BC-TKB	Klingen / Blades BC-B		1	1651 03 00001
BC-TKE	Klingen / Blades BC-E		1	1651 03 00002



B **HSS** SCHAFT SHANK Ø 2,6 mm

Entgrater-Klingen Typ BC-B
Deburring blades type BC-B

Typ Type	METAL	ALU	KUPFER COPPER	MESSING BRASS	GUSS CAST IRON	Plastic PVC	Artikel-Nr. Part-No.
Für gerade Kanten / For straight edges							
B10 BC-B10							10 1659 03 00010
B20 BC-B20							10 1659 03 00020

E **HSS** LANGER SCHAFT LONG SHANK Ø 3,2 mm

Entgrater-Klingen Typ BC-E
Deburring blades type BC-E

Typ Type	METAL	ALU	KUPFER COPPER	MESSING BRASS	GUSS CAST IRON	Plastic PVC	Artikel-Nr. Part-No.
Für gerade Kanten / For straight edges							
E100 BC-E100							10 1660 03 00100
E200 BC-E200							10 1660 03 00200
E350 BC-E350							10 1660 03 00350
Für Innenbearbeitung Vorder- und Rückseite gleichzeitig / For simultaneous deburring of int. and ext. edges							
E300 BC-E300							10 1660 03 00300
Für Innenbearbeitung Rückseite bis 20 mm Materialstärke / For backside deburring up to 20 mm thickness							
E600 BC-E600							5 1660 03 00600



ENTGRATER
DEBURRING TOOLS

Entgrater Deburring tools

HSS Schnellentgrater Rapid deburrers

Typ Type			Artikel-Nr. Part-No.		Artikel-Nr. Part-No.
BC-1	Feste Klinge / Fixed blade		1	1653 07 00001	-
BC1-10	BC-E100		-	-	10

Typ Type			Artikel-Nr. Part-No.		Artikel-Nr. Part-No.
BC-2	Auswechselbare Klinge / Replaceable blade BC-E100		1	1654 07 00001	-
BC2-5			-	-	5

HSS Dreikantschaber Triangular scrapers

Typ Type			Artikel-Nr. Part-No.
BC-DS3	Feste Klinge / Fixed blade 3 mm		1
BC-DS8	Auswechselbare Klinge / Replaceable blade 8 mm		1

C HSS Ersatz-Klinge 8 mm für BC-DS8 Spare blade 8 mm for type BC-DS8

Typ Type			METAL	ALU	KUPFER COPPER	MESSING BRASS	GUSS CAST IRON	Plastic PVC	Artikel-Nr. Part-No.
C42	BC-C42								1

HSS Handgriffe mit HSS-Klingen
Handles with HSS-blades

Typ Type	Teile Pieces			Artikel-Nr. Part-No.
BC-HE1	2	 BC-E100  BC-HE	1	1652 03 00001
BC-HE3	4	 BC-E100  BC-E200  BC-E350  BC-HE	1	1652 03 00002
BC-HTB4	4	 BC-TKB  BC-B10  BC-B20  BC-HK	1	1652 03 00003



ENTGRATER
DEBURRING TOOLS

Entgrater
Deburring tools

HSS Doppelentgrater mit HSS-Schneidscheiben
Double deburrer with round HSS-blades

Typ Type			Artikel-Nr. Part-No.
BC-DE		1	1655 03 00001

HSS Ersatz-Schneidscheibe für Doppelentgrater BC-DE
Spare round blade for double deburrer BC-DE

	Typ Type	Passend für Suitable for			Artikel-Nr. Part-No.
	BC-R12	Doppelentgrater / Double deburrer BC-DE		2	1655 03 00002



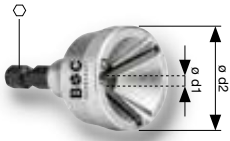

Code **EGR HSS**



Code **EGR HM+**



Code **EGR 35 HM+**



Code **EGR 54 HM+**



Besonders zur Reparatur von beschädigten Schrauben, Gewindestangen, Radbolzen, etc. geeignet.

Mit niedriger Drehzahl arbeiten!

- Einsatz in Akkuschrauber und Bohrmaschine
- Einfache Handhabung
- Schnelles und sicheres Arbeiten
- Verdeckte Schneiden
- Sichere Spanabfuhr

Especially designed for repairing damaged screws, bolts, threaded rods etc.

Please work with low rotation-speed!

- For use with cordless and corded machines
- Easy handling
- Fast and safe working
- Covered cutting edges
- Safe chip removal

Typ Type	Ø d1-d2 mm	Hexagon	Klingen Blades	max. U/min. rpm max.	Phone icon	Box icon	Artikel-Nr. Part-No.
EGR HSS	3 – 19	1/4" / 6,35 mm	3 x HSS	400	1	-	1648 16 00001
EGR HM+	3 – 19	1/4" / 6,35 mm	3 x HM/TC	400	1	-	1648 16 00002
EGR 35 HM+	13 – 35	SW 9	5 x HM/TC	150	1	-	1648 16 00003
EGR 54 HM+	34 – 54	SW 9	9 x HM/TC	150	-	1	1648 16 00004

EGR HM+ Ausführung:

- Längere Lebensdauer bei normalen Stählen
- Besonders für INOX und gehärtete Stähle geeignet

EGR HM+ version:

- Longer lifetime when working on standard steels
- Especially suitable for stainless and hardened steels

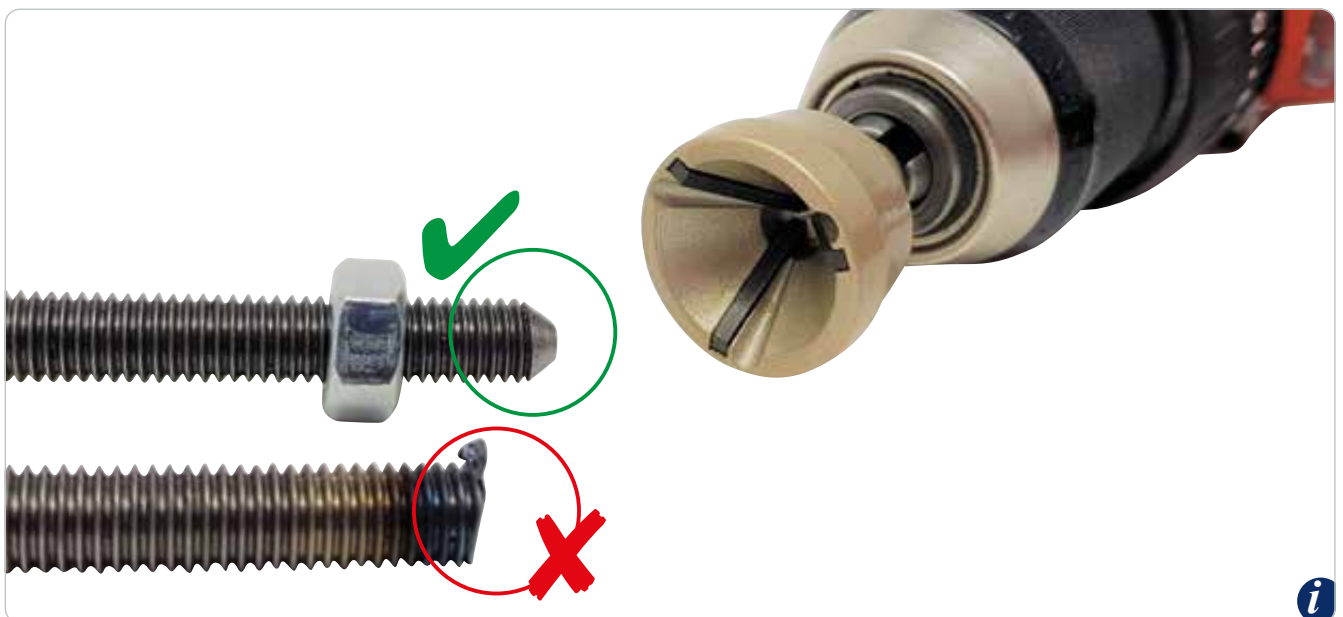



HSS FRÄSSTIFTE
HSS ROTARY BURRS



		DIN	Qualität Quality	Form Shape	Bezeichnung Description	Code	Seite Page
HSS Frässtifte Schaft 6 mm / HSS Rotary burrs shank 6 mm							
		BC Norm	HSS	B ZYAS	Frässtifte Zylinder mit Stirnverzahnung Rotary burrs cylinder with endcut	5205	294
		BC Norm	HSS	C WRC	Frässtifte Walzenrund Rotary burrs ball nosed cylinder	5210	294
		BC Norm	HSS	D KUD	Frässtifte Kugel Rotary burrs ball	5215	295
		BC Norm	HSS	G SPG	Frässtifte Spitzbogen Rotary burrs pointed tree	5230	295
		BC Norm	HSS	L KEL	Frässtifte Rundkegel Rotary burrs ball nosed cone	5250	296
		BC Norm	HSS	M SKM	Frässtifte Spitzkegel Rotary burrs cone	5255	296
					Sortimente Sets	5902	297

Lieferbare Ausführung Available version



HSS Frässtifte mit mittlerer Einfachverzahnung und Spanbrecher. Für die Bearbeitung von Stahl, Stahlguss und Gusseisen.

HSS rotary burrs with medium single tothing and chip breaker. For machining of steel, cast steel and cast iron.

ZYAS | HSS Frässtifte Form B Zylinder mit Stirnverzahnung

HSS rotary burrs shape B cylinder with endcut

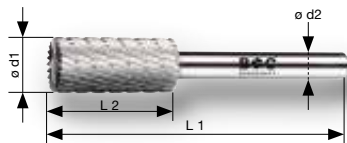

Code 5205



Zum Entgraten, Kantenbrechen, Verputzen, zur Schweißnaht- und Flächenbearbeitung.

To deburr, break edges, trim, process welding seams and surface processing.



$\varnothing d1$ mm	L2 mm	L1 mm	$\varnothing d2$ mm		Z3-SP
6	16	56	6	1	5205 03 00600
8	20	60	6	1	5205 03 00800
10	20	60	6	1	5205 03 01000
12	25	65	6	1	5205 03 01200
16	25	65	6	1	5205 03 01600

WRC | HSS Frässtifte Form C Walzenrund

HSS rotary burrs shape C ball nosed cylinder

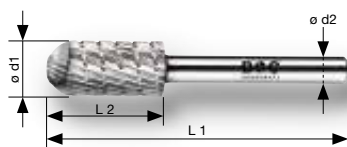

Code 5210



Zum Entgraten, Kantenbrechen, Verputzen, zur Schweißnaht- und Flächenbearbeitung.

To deburr, break edges, trim, process welding seams and surface processing.



$\varnothing d1$ mm	L2 mm	L1 mm	$\varnothing d2$ mm		Z3-SP
6	16	56	6	1	5210 03 00600
8	20	60	6	1	5210 03 00800
10	20	60	6	1	5210 03 01000
12	25	65	6	1	5210 03 01200
16	25	65	6	1	5210 03 01600



HSS FRÄSSTIFTE
HSS ROTARY BURRS

HSS Frässtifte Form D Kugel | HSS rotary burrs shape D ball | **KUD**

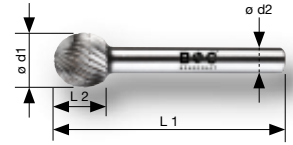

Code 5215



Zum Entgraten, Kantenbrechen, Verputzen, zur Schweißnaht- und Flächenbearbeitung.

To deburr, break edges, trim, process welding seams and surface processing.



$\varnothing d1$ mm	L2 mm	L1 mm	$\varnothing d2$ mm		Z3-SP
6	5	45	6	1	5215 03 00600
8	7	47	6	1	5215 03 00800
10	9	49	6	1	5215 03 01000
12	10	50	6	1	5215 03 01200
16	14	54	6	1	5215 03 01600



HSS Frässtifte Form G Spitzbogen | HSS rotary burrs shape G pointed tree | **SPG**

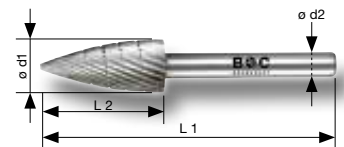

Code 5230

Zum Entgraten, Kantenbrechen, Verputzen, zur Schweißnaht- und Flächenbearbeitung.

To deburr, break edges, trim, process welding seams and surface processing.



$\varnothing d1$ mm	L2 mm	L1 mm	$\varnothing d2$ mm		Z3-SP
6	18	58	6	1	5230 03 00600
10	20	60	6	1	5230 03 01000
12	25	65	6	1	5230 03 01200

HSS FRÄSSTIFTE
HSS ROTARY BURRS

KEL | HSS Frässtifte Form L Rundkegel
HSS rotary burrs shape L ball nosed cone

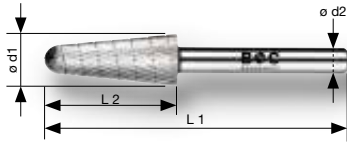

Code 5250



Zum Entgraten, Kantenbrechen, Verputzen, zur Schweißnaht- und Flächenbearbeitung.

To deburr, break edges, trim, process welding seams and surface processing.



Ø d1 mm	L2 mm	L1 mm	Ø d2 mm		Z3-SP
12	30	70	6	1	5250 03 01200
16	30	70	6	1	5250 03 01600



SKM | HSS Frässtifte Form M Spitzkegel
HSS rotary burrs shape M cone

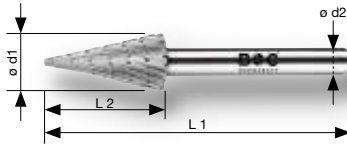

Code 5255



Zum Entgraten, Kantenbrechen, Verputzen, zur Schweißnaht- und Flächenbearbeitung.

To deburr, break edges, trim, process welding seams and surface processing.



Ø d1 mm	L2 mm	L1 mm	Ø d2 mm		Z3-SP
6	18	58	6	1	5255 03 00600
10	20	60	6	1	5255 03 01000
12	25	65	6	1	5255 03 01200

HSS FRÄSSTIFTE
HSS ROTARY BURRS

BC Boxen / BC Boxes

Bezeichnung Description	Teile Pieces	Inhalt Content	Artikel-Nr. Part-No.
R3 HSS	3	1x B · D · G, Ø 10 mm	5902 13 30003
R5 HSS	5	1x B · C · D · G · M, Ø 10 mm	5902 13 30005



R3 HSS



R5 HSS





HARTMETALL FRÄSSTIFTE
CARBIDE ROTARY BURRS



		DIN	Qualität Quality	Form Shape	Bezeichnung Description	Code	Seite Page
Frässtifte Schaft 6 mm / Rotary burrs shank 6 mm							
		8033*	HM TC	A ZYA	Frässtifte Zylinder Rotary burrs cylinder	5100 – 5104	302
		8033*	HM TC	B ZYAS	Frässtifte Zylinder mit Stirnverzahnung Rotary burrs cylinder with endcut	5105 – 5109	303
		8033*	HM TC	C WRC	Frässtifte Walzenrund Rotary burrs ball nosed cylinder	5110 – 5114	304
		8033*	HM TC	D KUD	Frässtifte Kugel Rotary burrs ball	5115 – 5119	305
		8033*	HM TC	E TRE	Frässtifte Tropfen Rotary burrs oval	5120 – 5124	306
		8033*	HM TC	F RBF	Frässtifte Rundbogen Rotary burrs ball nosed tree	5125 – 5129	307
		8033*	HM TC	G SPG	Frässtifte Spitzbogen Rotary burrs pointed tree	5130 – 5134	308
		8033*	HM TC	H FLH	Frässtifte Flamme Rotary burrs flame	5135 – 5136	309
		8033*	HM TC	J KSJ	Frässtifte Kegel 60° Rotary burrs countersink 60°	5140 – 5141	309
		8033*	HM TC	K KSK	Frässtifte Kegel 90° Rotary burrs countersink 90°	5145 – 5146	310
		8033*	HM TC	L KEL	Frässtifte Rundkegel Rotary burrs ball nosed cone	5150 – 5154	311
		8033*	HM TC	M SKM	Frässtifte Spitzkegel Rotary burrs cone	5155 – 5159	310
		8033*	HM TC	N WKN	Frässtifte Winkel Rotary burrs inverted cone	5160 – 5161	312
		BC Norm	HM TC	RX	Frässtift Radius Rotary burr radius	5170	312
		8033*	HM TC		Kleinfrässtifte, Schaft 3 mm Miniature carbide rotary burrs, shank 3 mm	5100 – 5160	313
		8033*	HM TC		Frässtifte, Schaft 8 mm Rotary burrs, shank 8 mm	5100 – 5151	314
		8033*	HM TC		Frässtifte, extra lang, Schaft 6 mm Rotary burrs, extra long, shank 6 mm	5100 – 5151	315
					Sortimente + Display Sets + display	5900 – 5905	316 – 317

* Frässtifte ähnlich DIN 8033 / * Rotary burrs similar to DIN 8033

Z3-X



Hartmetall-Frässtifte mit Kreuzverzahnung für hohen Materialabtrag bei Gusseisen, Stahl und Edelstahl.

Carbide rotary burrs with cross toothing for high stock removal of cast iron, steel and stainless steel.

Z3-X

TiALN



Hartmetall-Frässtifte mit Kreuzverzahnung und zusätzlicher TiALN-Beschichtung. Durch die Beschichtung höhere Oberflächenhärte und höhere Warmhärtebeständigkeit wodurch die Standzeit deutlich erhöht wird.

Carbide rotary burrs with cross toothing and additional TiALN-coating. Due to the coating the rotary burrs have a higher surface hardness and a higher heat resistance which increases the tool life.

Z4



Hartmetall-Frässtifte mit feiner Diamantverzahnung für härtere Werkstoffe.

Carbide rotary burrs with fine diamond toothing for harder materials.

Z5



Hartmetall-Frässtifte mit feiner Einfachverzahnung für saubere Oberflächen bei der Bearbeitung von Gusseisen, Stahl, Edelstahl und härteren Werkstoffen.

Carbide rotary burrs with fine single toothing for a clean surface finish. For machining cast iron, steel, stainless steel and harder materials.

Z-ALU



Hartmetall-Frässtifte mit Alu-Verzahnung für die Bearbeitung von Aluminium und Aluminiumlegierungen, NE-Metallen und Kunststoffen.

Carbide rotary burrs with aluminium-toothing for machining of aluminium and aluminium-alloys, non-ferrous metals and plastics.

Z3-X SCHAFT SHANK
Ø 3 mm



Hartmetall-Frässtifte mit 3 mm Schaft und Kreuzverzahnung für hohen Materialabtrag bei Gusseisen, Stahl und Edelstahl.
Miniature carbide rotary burrs with 3 mm shank and cross tooting for high stock removal of cast iron, steel and stainless steel.

Z3-X SCHAFT SHANK
Ø 8 mm



Hartmetall-Frässtifte mit 8 mm Schaft und Kreuzverzahnung für hohen Materialabtrag bei Gusseisen, Stahl und Edelstahl.
Carbide rotary burrs with 8 mm shank cross tooting for high stock removal of cast iron, steel and stainless steel.

Z3-X LANGE LONG Version



Hartmetall-Frässtifte mit langem Schaft für schwer zugängliche Stellen.
Carbide rotary burrs with long shank for difficult accessible places.

Z5 **RX**



Perfekt zur Kantenbearbeitung. Die spezielle Kombi-Form verhindert ein Abrutschen vom Werkstück.
Perfect for edge processing. The special combined shape prevents slipping off the workpiece.



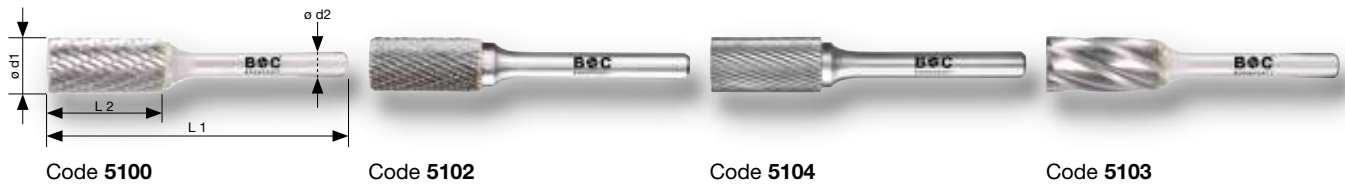

Zum Entgraten, Kantenbrechen, Verputzen, zur Schweißnaht- und Flächenbearbeitung.

To deburr, break edges, trim, process welding seams and surface processing.



Ø d1 mm	L2 mm	L1 mm	Ø d2 mm		Z3-X	Z3-X TiAlN	Z4	Z5	Z-ALU
3 mm Schaft / 3 mm shank									
3	13	38	3	1	5100 03 00303	5101 03 00303	-	5104 03 00303	-
6	13	48	3	1	5100 03 00603	5101 03 00603	-	5104 03 00603	-
6 mm Schaft / 6 mm shank									
6	16	50	6	1	5100 03 00600	5101 03 00600	5102 03 00600	5104 03 00600	5103 03 00600
8	20	64	6	1	5100 03 00800	5101 03 00800	5102 03 00800	5104 03 00800	-
10	20	64	6	1	5100 03 01000	5101 03 01000	5102 03 01000	5104 03 01000	5103 03 01000
12	25	70	6	1	5100 03 01200	5101 03 01200	5102 03 01200	5104 03 01200	5103 03 01200
16	25	70	6	1	5100 03 01600	5101 03 01600	-	-	-
19	25	70	6	1	5100 03 01900	5101 03 01900	-	-	-
6 mm Schaft, lange Ausführung* / 6 mm shank, long version*									
6	16	100	6	1	5100 03 06100	5101 03 06100	-	-	-
6	16	150	6	1	5100 03 06150	5101 03 06150	-	-	-
8	20	170	6	1	5100 03 08170	5101 03 08170	-	-	-
10	20	170	6	1	5100 03 10170	5101 03 10170	-	-	-
12	25	175	6	1	5100 03 12175	5101 03 12175	-	-	-
8 mm Schaft / 8 mm shank									
12	25	70	8	1	5100 03 01208	5101 03 01208	-	-	-
16	25	70	8	1	5100 03 01608	5101 03 01608	-	-	-

* Bitte reduzierte Drehzahl anwenden! Details auf Seite 458. / Please use reduced speed! Details on page 458.

SB-Verpackung / Display packaging



Ø d1 mm	L2 mm	L1 mm	Ø d2 mm		Z3-X
6	16	50	6	1	5100 05 00600
10	20	64	6	1	5100 05 01000
12	25	70	6	1	5100 05 01200

Hartmetall Frässtifte Form B Zylinder mit Stirnverzahnung | ZYAS

Carbide rotary burrs shape B cylinder with endcut



Zum Entgraten, Kantenbrechen, Verputzen, zur Schweißnaht- und Flächenbearbeitung.

To deburr, break edges, trim, process welding seams and surface processing.



Ø d1 mm	L2 mm	L1 mm	Ø d2 mm		Z3-X	Z3-X TiAlN	Z4	Z5	Z-ALU
3 mm Schaft / 3 mm shank									
3	13	38	3	1	5105 03 00303	5106 03 00303	-	5109 03 00303	5108 03 00303
6	13	48	3	1	5105 03 00603	5106 03 00603	-	5109 03 00603	5108 03 00603
6 mm Schaft / 6 mm shank									
6	16	50	6	1	5105 03 00600	5106 03 00600	5107 03 00600	5109 03 00600	5108 03 00600
8	20	64	6	1	5105 03 00800	5106 03 00800	5107 03 00800	5109 03 00800	-
10	20	64	6	1	5105 03 01000	5106 03 01000	5107 03 01000	5109 03 01000	5108 03 01000
12	25	70	6	1	5105 03 01200	5106 03 01200	5107 03 01200	5109 03 01200	5108 03 01200
16	25	70	6	1	5105 03 01600	5106 03 01600	-	-	-
19	25	70	6	1	5105 03 01900	5106 03 01900	-	-	-
6 mm Schaft, lange Ausführung* / 6 mm shank, long version*									
6	16	100	6	1	5105 03 06100	5106 03 06100	-	-	-
6	16	150	6	1	5105 03 06150	5106 03 06150	-	-	-
8	20	170	6	1	5105 03 08170	5106 03 08170	-	-	-
10	20	170	6	1	5105 03 10170	5106 03 10170	-	-	-
12	25	175	6	1	5105 03 12175	5106 03 12175	-	-	-
8 mm Schaft / 8 mm shank									
12	25	70	8	1	5105 03 01208	5106 03 01208	-	-	-
16	25	70	8	1	5105 03 01608	5106 03 01608	-	-	-

* Bitte reduzierte Drehzahl anwenden! Details auf Seite 458. / Please use reduced speed! Details on page 458.

SB-Verpackung / Display packaging



Ø d1 mm	L2 mm	L1 mm	Ø d2 mm		Z3-X
6	16	50	6	1	5105 05 00600
10	20	64	6	1	5105 05 01000
12	25	70	6	1	5105 05 01200



HM FRÄSSTIFTE
CARBIDE ROTARY BURRS

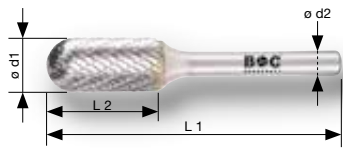

Code 5110



Code 5112



Code 5114



Code 5113



Zum Entgraten, Kantenbrechen, Verputzen, zur Schweißnaht- und Flächenbearbeitung.

To deburr, break edges, trim, process welding seams and surface processing.



Ø d1 mm	L2 mm	L1 mm	Ø d2 mm		Z3-X	Z3-X TiAlN	Z4	Z5	Z-ALU
3 mm Schaft / 3 mm shank									
3	13	38	3	1	5110 03 00303	5111 03 00303	-	5114 03 00303	5113 03 00303
6	13	48	3	1	5110 03 00603	5111 03 00603	-	5114 03 00603	5113 03 00603
6 mm Schaft / 6 mm shank									
6	16	50	6	1	5110 03 00600	5111 03 00600	5112 03 00600	5114 03 00600	5113 03 00600
8	20	64	6	1	5110 03 00800	5111 03 00800	5112 03 00800	5114 03 00800	-
10	20	64	6	1	5110 03 01000	5111 03 01000	5112 03 01000	5114 03 01000	5113 03 01000
12	25	70	6	1	5110 03 01200	5111 03 01200	5112 03 01200	5114 03 01200	5113 03 01200
16	25	70	6	1	5110 03 01600	5111 03 01600	-	-	-
19	25	70	6	1	5110 03 01900	5111 03 01900	-	-	-
6 mm Schaft, lange Ausführung* / 6 mm shank, long version*									
6	16	100	6	1	5110 03 06100	5111 03 06100	-	-	-
6	16	150	6	1	5110 03 06150	5111 03 06150	-	-	-
8	20	170	6	1	5110 03 08170	5111 03 08170	-	-	-
10	20	170	6	1	5110 03 10170	5111 03 10170	-	-	-
12	25	175	6	1	5110 03 12175	5111 03 12175	-	-	-
8 mm Schaft / 8 mm shank									
12	25	70	8	1	5110 03 01208	5111 03 01208	-	-	-
16	25	70	8	1	5110 03 01608	5111 03 01608	-	-	-

* Bitte reduzierte Drehzahl anwenden! Details auf Seite 458. / Please use reduced speed! Details on page 458.

SB-Verpackung / Display packaging



Ø d1 mm	L2 mm	L1 mm	Ø d2 mm		Z3-X
6	16	50	6	1	5110 05 00600
10	20	64	6	1	5110 05 01000
12	25	70	6	1	5110 05 01200

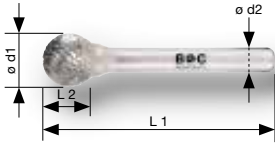

Code 5115



Code 5117



Code 5119



Code 5118



Zum Entgraten, Kantenbrechen, Verputzen, zur Schweißnaht- und Flächenbearbeitung.

To deburr, break edges, trim, process welding seams and surface processing.



Ø d1 mm	L2 mm	L1 mm	Ø d2 mm		Z3-X	Z3-X TiAlN	Z4	Z5	Z-ALU
3 mm Schaft / 3 mm shank									
3	2,5	38	3	1	5115 03 00303	5116 03 00303	-	5119 03 00303	5118 03 00303
4	3,0	38	3	1	5115 03 00403	5116 03 00403	-	-	-
6	5,0	40	3	1	5115 03 00603	5116 03 00603	-	5119 03 00603	5118 03 00603
6 mm Schaft / 6 mm shank									
6	5,0	50	6	1	5115 03 00600	5116 03 00600	5117 03 00600	-	5118 03 00600
8	6,0	52	6	1	5115 03 00800	5116 03 00800	5117 03 00800	-	-
10	9,0	54	6	1	5115 03 01000	5116 03 01000	5117 03 01000	5119 03 01000	5118 03 01000
12	10,0	56	6	1	5115 03 01200	5116 03 01200	5117 03 01200	5119 03 01200	5118 03 01200
16	14,0	59	6	1	5115 03 01600	5116 03 01600	-	-	-
19	18,0	63	6	1	5115 03 01900	5116 03 01900	-	-	-
6 mm Schaft, lange Ausführung* / 6 mm shank, long version*									
8	6,0	170	6	1	5115 03 08170	5116 03 08170	-	-	-
10	8,0	170	6	1	5115 03 10170	5116 03 10170	-	-	-
12	11,0	175	6	1	5115 03 12175	5116 03 12175	-	-	-
8 mm Schaft / 8 mm shank									
12	10,0	56	8	1	5115 03 01208	5116 03 01208	-	-	-
16	14,0	59	8	1	5115 03 01608	5116 03 01608	-	-	-

* Bitte reduzierte Drehzahl anwenden! Details auf Seite 458. / Please use reduced speed! Details on page 458.

SB-Verpackung / Display packaging



Ø d1 mm	L2 mm	L1 mm	Ø d2 mm		Z3-X
6	5	50	6	1	5115 05 00600
10	9	54	6	1	5115 05 01000
12	10	56	6	1	5115 05 01200



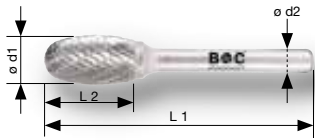

Code 5120



Code 5121 TiALN



Code 5124



Zum Entgraten, Kantenbrechen, Verputzen, zur Schweißnaht- und Flächenbearbeitung.

To deburr, break edges, trim, process welding seams and surface processing.



Ø d1 mm	L2 mm	L1 mm	Ø d2 mm		Z3-X	Z3-X TiALN	Z5
3 mm Schaft / 3 mm shank							
3	6	38	3	1	5120 03 00303	5121 03 00303	5124 03 00303
6	10	45	3	1	5120 03 00603	5121 03 00603	5124 03 00603
6 mm Schaft / 6 mm shank							
6	10	50	6	1	5120 03 00600	5121 03 00600	-
8	13	60	6	1	5120 03 00800	5121 03 00800	-
10	16	60	6	1	5120 03 01000	5121 03 01000	-
12	20	65	6	1	5120 03 01200	5121 03 01200	-
16	25	70	6	1	5120 03 01600	5121 03 01600	-
19	25	70	6	1	5120 03 01900	5121 03 01900	-
6 mm Schaft, lange Ausführung* / 6 mm shank, long version*							
10	16	170	6	1	5120 03 10170	5121 03 10170	-
12	22	175	6	1	5120 03 12175	5121 03 12175	-
8 mm Schaft / 8 mm shank							
12	20	65	8	1	5120 03 01208	5121 03 01208	-
16	25	70	8	1	5120 03 01608	5121 03 01608	-

* Bitte reduzierte Drehzahl anwenden! Details auf Seite 458. / Please use reduced speed! Details on page 458.

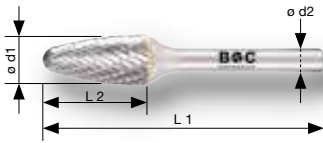

Code 5125



Code 5127



Code 5129



Code 5128



Zum Entgraten, Kantenbrechen, Verputzen, zur Schweißnaht- und Flächenbearbeitung.

To deburr, break edges, trim, process welding seams and surface processing.



Ø d1 mm	L2 mm	L1 mm	Ø d2 mm		Z3-X	Z3-X TiAlN	Z4	Z5	Z-ALU
3 mm Schaft / 3 mm shank									
3	13	38	3	1	5125 03 00303	5126 03 00303	-	5129 03 00303	5128 03 00303
6	13	48	3	1	5125 03 00603	5126 03 00603	-	5129 03 00603	5128 03 00603
6 mm Schaft / 6 mm shank									
6	18	60	6	1	5125 03 00600	5126 03 00600	5127 03 00600	5129 03 00600	5128 03 00600
8	20	64	6	1	5125 03 00800	5126 03 00800	5127 03 00800	5129 03 00800	-
10	20	64	6	1	5125 03 01000	5126 03 01000	5127 03 01000	5129 03 01000	5128 03 01000
12	25	70	6	1	5125 03 01200	5126 03 01200	5127 03 01200	5129 03 01200	5128 03 01200
16	25	70	6	1	5125 03 01600	5126 03 01600	-	-	-
19	25	70	6	1	5125 03 01900	5126 03 01900	-	-	-
6 mm Schaft, lange Ausführung* / 6 mm shank, long version*									
6	16	150	6	1	5125 03 06150	5126 03 06150	-	-	-
10	20	170	6	1	5125 03 10170	5126 03 10170	-	-	-
12	25	175	6	1	5125 03 12175	5126 03 12175	-	-	-
8 mm Schaft / 8 mm shank									
12	25	70	8	1	5125 03 01208	5126 03 01208	-	-	-
16	25	70	8	1	5125 03 01608	5126 03 01608	-	-	-

* Bitte reduzierte Drehzahl anwenden! Details auf Seite 458. / Please use reduced speed! Details on page 458.

SB-Verpackung / Display packaging



Ø d1 mm	L2 mm	L1 mm	Ø d2 mm		Z3-X
6	18	60	6	1	5125 05 00600
10	20	64	6	1	5125 05 01000
12	25	70	6	1	5125 05 01200



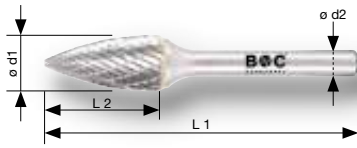

Code 5130



Code 5134



Code 5133



Zum Entgraten, Kantenbrechen, Verputzen, zur Schweißnaht- und Flächenbearbeitung.

To deburr, break edges, trim, process welding seams and surface processing.



Ø d1 mm	L2 mm	L1 mm	Ø d2 mm		Z3-X	Z3-X TiALN	Z5	Z-ALU
3 mm Schaft / 3 mm shank								
3	13	38	3	1	5130 03 00303	5131 03 00303	5134 03 00303	5133 03 00303
6	13	48	3	1	5130 03 00603	5131 03 00603	5134 03 00603	5133 03 00603
6 mm Schaft / 6 mm shank								
6	16	50	6	1	5130 03 00600	5131 03 00600	5134 03 00600	-
8	20	64	6	1	5130 03 00800	5131 03 00800	5134 03 00800	-
10	20	64	6	1	5130 03 01000	5131 03 01000	5134 03 01000	-
12	25	70	6	1	5130 03 01200	5131 03 01200	5134 03 01200	5133 03 01200
16	25	70	6	1	5130 03 01600	5131 03 01600	-	-
19	25	70	6	1	5130 03 01900	5131 03 01900	-	-
6 mm Schaft, lange Ausführung* / 6 mm shank, long version*								
10	20	170	6	1	5130 03 10170	5131 03 10170	-	-
12	25	175	6	1	5130 03 12175	5131 03 12175	-	-
8 mm Schaft / 8 mm shank								
12	25	70	8	1	5130 03 01208	5131 03 01208	-	-
16	25	70	8	1	5130 03 01608	5131 03 01608	-	-

* Bitte reduzierte Drehzahl anwenden! Details auf Seite 458. / Please use reduced speed! Details on page 458.

SB-Verpackung / Display packaging

Ø d1 mm	L2 mm	L1 mm	Ø d2 mm		Z3-X
6	16	50	6	1	5130 05 00600
10	20	64	6	1	5130 05 01000
12	25	70	6	1	5130 05 01200

Hartmetall Frässtifte Form H Flamme | **FLH**
 Carbide rotary burrs shape H flame

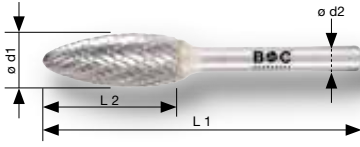

Code 5135



Code 5136 TiALN



Zum Entgraten, Kantenbrechen, Verputzen, zur Schweißnaht- und Flächenbearbeitung.

To deburr, break edges, trim, process welding seams and surface processing.



Ø d1 mm	L2 mm	L1 mm	Ø d2 mm		Z3-X	Z3-X TiALN
3 mm Schaft / 3 mm shank						
3	6	38	3	1	5135 03 00303	5136 03 00303
6 mm Schaft / 6 mm shank						
6	18	50	6	1	5135 03 00600	5136 03 00600
8	20	64	6	1	5135 03 00800	5136 03 00800
10	20	64	6	1	5135 03 01000	5136 03 01000
12	32	77	6	1	5135 03 01200	5136 03 01200
16	36	81	6	1	5135 03 01600	5136 03 01600
19	38	83	6	1	5135 03 01900	5136 03 01900

Hartmetall Frässtifte Form J Kegel 60° | **KSJ**
 Carbide rotary burrs shape J countersink 60°

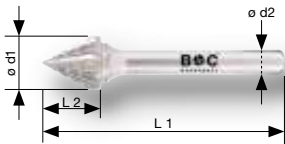

Code 5140



Code 5141 TiALN



Zum Entgraten, Kantenbrechen, Verputzen, zur Schweißnaht- und Flächenbearbeitung.

To deburr, break edges, trim, process welding seams and surface processing.

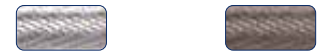

Ø d1 mm	L2 mm	L1 mm	Ø d2 mm		Z3-X	Z3-X TiALN
3 mm Schaft / 3 mm shank						
3	2,5	38	3	1	5140 03 00303	-
6 mm Schaft / 6 mm shank						
6	4,0	50	6	1	5140 03 00600	5141 03 00600
10	8,0	53	6	1	5140 03 01000	-
12	11,0	55	6	1	5140 03 01200	5141 03 01200
16	14,0	60	6	1	5140 03 01600	-

HM FRÄSSTIFTE
 CARBIDE ROTARY BURRS

KSK | Hartmetall Frässtifte Form K Kegel 90°
Carbide rotary burrs shape K countersink 90°

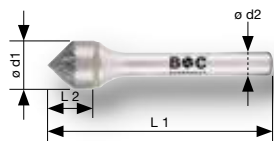

Code 5145



Code 5146 TiALN



Zum Entgraten, Kantenbrechen, Verputzen, zur Schweißnaht- und Flächenbearbeitung.

To deburr, break edges, trim, process welding seams and surface processing.



Ø d1 mm	L2 mm	L1 mm	Ø d2 mm		Z3-X	Z3-X TiALN
3 mm Schaft / 3 mm shank						
3	1,5	38	3	1	5145 03 00303	-
6 mm Schaft / 6 mm shank						
6	3,0	50	6	1	5145 03 00600	5146 03 00600
10	4,7	50	6	1	5145 03 01000	-
12	6,0	52	6	1	5145 03 01200	5146 03 01200
16	8,0	54	6	1	5145 03 01600	-

SKM | Hartmetall Frässtifte Form M Spitzkegel
Carbide rotary burrs shape M cone

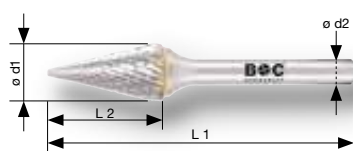

Code 5155



Code 5156 TiALN



Code 5159



Zum Entgraten, Kantenbrechen, Verputzen, zur Schweißnaht- und Flächenbearbeitung.

To deburr, break edges, trim, process welding seams and surface processing.



Ø d1 mm	L2 mm	L1 mm	Ø d2 mm		Z3-X	Z3-X TiALN	Z5
3 mm Schaft / 3 mm shank							
3	11	38	3	1	5155 03 00303	5156 03 00303	-
6	13	45	3	1	5155 03 00603	5156 03 00603	5159 03 00603
6 mm Schaft / 6 mm shank							
6	18	50	6	1	5155 03 00600	5156 03 00600	-
8	20	64	6	1	5155 03 00800	5156 03 00800	-
10	20	64	6	1	5155 03 01000	5156 03 01000	-
12	25	71	6	1	5155 03 01200	5156 03 01200	-
16	25	71	6	1	5155 03 01600	5156 03 01600	-

HM FRÄSSTIFTE
CARBIDE ROTARY BURRS

Hartmetall Frässtifte Form L Rundkegel Carbide rotary burrs shape L ball nosed cone

KEL

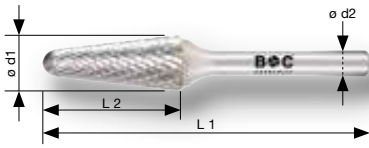

Code 5150



Code 5154



Code 5153



Zum Entgraten, Kantenbrechen, Verputzen, zur Schweißnaht- und Flächenbearbeitung.

To deburr, break edges, trim, process welding seams and surface processing.



Ø d1 mm	L2 mm	L1 mm	Ø d2 mm		Z3-X	Z3-X TiAlN	Z5	Z-ALU
3 mm Schaft / 3 mm shank								
3	13	38	3	1	5150 03 00303	5151 03 00303	5154 03 00303	-
6	13	48	3	1	5150 03 00603	5151 03 00603	5154 03 00603	-
6 mm Schaft / 6 mm shank								
6	16	50	6	1	5150 03 00600	5151 03 00600	-	5153 03 00600
8	22	68	6	1	5150 03 00800	5151 03 00800	5154 03 00800	-
10	25	72	6	1	5150 03 01000	5151 03 01000	5154 03 01000	5153 03 01000
12	28	75	6	1	5150 03 01200	5151 03 01200	5154 03 01200	5153 03 01200
16	33	78	6	1	5150 03 01600	5151 03 01600	-	5153 03 01600
19	38	83	6	1	5150 03 01900	5151 03 01900	-	-
6 mm Schaft, lange Ausführung* / 6 mm shank, long version*								
10	25	170	6	1	5150 03 10170	5151 03 10170	-	-
12	28	175	6	1	5150 03 12175	5151 03 12175	-	-
8 mm Schaft / 8 mm shank								
12	28	75	8	1	5150 03 01208	5151 03 01208	-	-
16	33	78	8	1	5150 03 01608	5151 03 01608	-	-

* Bitte reduzierte Drehzahl anwenden! Details auf Seite 458. / Please use reduced speed! Details on page 458.

SB-Verpackung / Display packaging



Ø d1 mm	L2 mm	L1 mm	Ø d2 mm		Z3-X
6	16	50	6	1	5150 05 00600
10	25	72	6	1	5150 05 01000
12	28	75	6	1	5150 05 01200



HM FRÄSSTIFTE
CARBIDE ROTARY BURRS

WKN | Hartmetall Frässtifte Form N Winkel
Carbide rotary burrs shape N inverted cone



Code 5160



Code 5161 TiAlN



Zum Entgraten, Kantenbrechen, Verputzen, zur Schweißnaht- und Flächenbearbeitung.

To deburr, break edges, trim, process welding seams and surface processing.

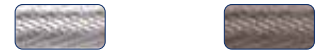

Ø d1 mm	L2 mm	L1 mm	Ø d2 mm		Z3-X	Z3-X TiAlN
3 mm Schaft / 3 mm shank						
3	4,0	38	3	1	5160 03 00303	-
6 mm Schaft / 6 mm shank						
6	7,0	50	6	1	5160 03 00600	5161 03 00600
10	9,5	55	6	1	5160 03 01000	-
12	13,0	58	6	1	5160 03 01200	5161 03 01200
16	16,0	62	6	1	5160 03 01600	-



HM FRÄSSTIFTE
CARBIDE ROTARY BURRS

RX | Hartmetall Frässtifte Form RX Radius
Carbide rotary burrs shape RX radius



Code 5170



Perfekt zur Kantenbearbeitung. Die spezielle Kombi-Form verhindert ein Abrutschen vom Werkstück.

Perfect for edge processing. The special combined shape prevents slipping off the workpiece.



Ø d1 mm	L2 mm	L1 mm	Ø d2 mm			Z5
12	25	70	6	1	-	5170 03 01200
12	25	70	6	-	1	5170 05 01200

Hartmetall Kleinfrässtifte, Kreuzverzahnung, **Schaft 3 mm**
 Miniature carbide rotary burrs, cross toothing, **shank 3 mm**



Zum Entgraten, Kantenbrechen, Verputzen, zur Schweißnaht- und Flächenbearbeitung.

To deburr, break edges, trim, process welding seams and surface processing.



Form Shape	DIN 8033	Ø d1 mm	L2 mm	L1 mm	Ø d2 mm	Bezeichnung Description		Z3-X	Z3-X TiAlN	Z5	Z-ALU
A	ZYA	3	13,0	38	3	Zylinder	1	5100 03 00303	5101 03 00303	5104 03 00303	-
		6	13,0	48	3	Cylinder	1	5100 03 00603	5101 03 00603	5104 03 00603	-
B	ZYAS	3	13,0	38	3	Zylinder Stirnverzahnung	1	5105 03 00303	5106 03 00303	5109 03 00303	5108 03 00303
		6	13,0	48	3	Cylinder endcut	1	5105 03 00603	5106 03 00603	5109 03 00603	5108 03 00603
C	WRC	3	13,0	38	3	Walzenrund	1	5110 03 00303	5111 03 00303	5114 03 00303	5113 03 00303
		6	13,0	48	3	Ball nosed cylinder	1	5110 03 00603	5111 03 00603	5114 03 00603	5113 03 00603
D	KUD	3	2,5	38	3	Kugel	1	5115 03 00303	5116 03 00303	5119 03 00303	5118 03 00303
		4	3,0	38	3	Ball	1	5115 03 00403	5116 03 00403	-	-
		6	5,0	40	3		1	5115 03 00603	5116 03 00603	5119 03 00603	5118 03 00603
E	TRE	3	6,0	38	3	Tropfen	1	5120 03 00303	5121 03 00303	5124 03 00303	-
		6	10,0	45	3	Oval	1	5120 03 00603	5121 03 00603	5124 03 00603	-
F	RBF	3	13,0	38	3	Rundbogen	1	5125 03 00303	5126 03 00303	5129 03 00303	5128 03 00303
		6	13,0	48	3	Nosed tree	1	5125 03 00603	5126 03 00603	5129 03 00603	5128 03 00603
G	SPG	3	13,0	38	3	Spitzbogen	1	5130 03 00303	5131 03 00303	5134 03 00303	5133 03 00303
		6	13,0	48	3	Pointed tree	1	5130 03 00603	5131 03 00603	5134 03 00603	5133 03 00603
H	FLH	3	6,0	38	3	Flamme / Flame	1	5135 03 00303	5136 03 00303	-	-
J	KSJ	3	2,5	38	3	Kegel / Countersink 60°	1	5140 03 00303	-	-	-
K	KSK	3	1,5	38	3	Kegel / Countersink 90°	1	5145 03 00303	-	-	-
L	KEL	3	13,0	38	3	Rundkegel	1	5150 03 00303	5151 03 00303	5154 03 00303	-
		6	13,0	48	3	Ball nosed cone	1	5150 03 00603	5151 03 00603	5154 03 00603	-
M	SKM	3	11,0	38	3	Spitzkegel	1	5155 03 00303	5156 03 00303	-	-
		6	13,0	48	3	Cone	1	5155 03 00603	5156 03 00603	5159 03 00603	-
N	WKN	3	4,0	38	3	Winkel / Inverted cone	1	5160 03 00303	-	-	-



HM FRÄSSTIFTE
CARBIDE ROTARY BURRS

Sortimente Hartmetall Kleinfrässtifte, Schaft 3 mm
 Assortments miniature carbide rotary burrs, shank 3 mm

BC Boxen / BC Boxes

Bezeichnung Description	Teile Pieces	Inhalt Content	Artikel-Nr. Part-No.
KF10	10	1x A · B · C · D · E · F · G · H · L · M, Ø 3 mm Z3-X Kreuzverzahnung / Cross toothing	5900 13 30014
KF15 Z3-X	15	1x B · C · D · E · F · G · M, Ø 3 + 6 mm 1x H, Ø 3 mm Z3-X Kreuzverzahnung / Cross toothing	5900 13 30015
KF15 Z5	15	1x B · C · D · E · F · G · L, Ø 3 + 6 mm 1x M, Ø 6 mm Z5 Feinverzahnung / Fine toothing	5905 13 30015



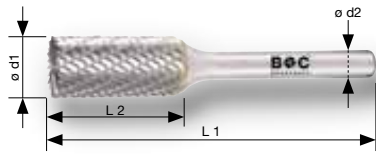

Code 5105



Code 5106



Code 5110



Zum Entgraten, Kantenbrechen, Verputzen, zur Schweißnaht- und Flächenbearbeitung.

To deburr, break edges, trim, process welding seams and surface processing.



Form Shape	DIN 8033	Ø d1 mm	L2 mm	L1 mm	Ø d2 mm	Bezeichnung Description		Z3-X	Z3-X TiALN
A	ZYA	12	25	70	8	Zylinder Cylinder	1	5100 03 01208	5101 03 01208
		16	25	70	8		1	5100 03 01608	5101 03 01608
B	ZYAS	12	25	70	8	Zylinder Stirnverzahnung Cylinder endcut	1	5105 03 01208	5106 03 01208
		16	25	70	8		1	5105 03 01608	5106 03 01608
C	WRC	12	25	70	8	Walzenrund Ball nosed cylinder	1	5110 03 01208	5111 03 01208
		16	25	70	8		1	5110 03 01608	5111 03 01608
D	KUD	12	10	56	8	Kugel Ball	1	5115 03 01208	5116 03 01208
		16	14	59	8		1	5115 03 01608	5116 03 01608
E	TRE	12	20	65	8	Tropfen Oval	1	5120 03 01208	5121 03 01208
		16	25	70	8		1	5120 03 01608	5121 03 01608
F	RBF	12	25	70	8	Rundbogen Nosed tree	1	5125 03 01208	5126 03 01208
		16	25	70	8		1	5125 03 01608	5126 03 01608
G	SPG	12	25	70	8	Spitzbogen Pointed tree	1	5130 03 01208	5131 03 01208
		16	25	70	8		1	5130 03 01608	5131 03 01608
L	KEL	12	28	75	8	Rundkegel Ball nosed cone	1	5150 03 01208	5151 03 01208
		16	33	78	8		1	5150 03 01608	5151 03 01608



Hartmetall Frässtifte mit langem Schaft, Kreuzverzahnung

Carbide rotary burrs with long shank, cross toothing



Code 5105-L



Code 5110-L



Zum Entgraten, Kantenbrechen, Verputzen, zur Schweißnaht- und Flächenbearbeitung.

To deburr, break edges, trim, process welding seams and surface processing.



Form Shape	DIN 8033	Ø d1 mm	L2 mm	L1 mm	Ø d2 mm	Bezeichnung Description		Z3-X	Z3-X TiAlN
A	ZYA	6	16	100	6	Zylinder Cylinder	1	5100 03 06100	5101 03 06100
		6	16	150	6		1	5100 03 06150	5101 03 06150
		8	20	170	6		1	5100 03 08170	5101 03 08170
		10	20	170	6		1	5100 03 10170	5101 03 10170
		12	25	175	6		1	5100 03 12175	5101 03 12175
B	ZYAS	6	16	100	6	Zylinder Stirnverzahnung Cylinder endcut	1	5105 03 06100	5106 03 06100
		6	16	150	6		1	5105 03 06150	5106 03 06150
		8	20	170	6		1	5105 03 08170	5106 03 08170
		10	20	170	6		1	5105 03 10170	5106 03 10170
		12	25	175	6		1	5105 03 12175	5106 03 12175
C	WRC	6	16	100	6	Walzenrund Ball nosed cylinder	1	5110 03 06100	5111 03 06100
		6	16	150	6		1	5110 03 06150	5111 03 06150
		8	20	170	6		1	5110 03 08170	5111 03 08170
		10	20	170	6		1	5110 03 10170	5111 03 10170
		12	25	175	6		1	5110 03 12175	5111 03 12175
D	KUD	8	6	170	6	Kugel Ball	1	5115 03 08170	5116 03 08170
		10	8	170	6		1	5115 03 10170	5116 03 10170
		12	11	175	6		1	5115 03 12175	5116 03 12175
E	TRE	10	16	170	6	Tropfen Oval	1	5120 03 10170	5121 03 10170
		12	22	175	6		1	5120 03 12175	5121 03 12175
F	RBF	6	16	150	6	Rundbogen Nosed tree	1	5125 03 06150	5126 03 06150
		10	20	170	6		1	5125 03 10170	5126 03 10170
		12	25	175	6		1	5125 03 12175	5126 03 12175
G	SPG	10	20	170	6	Spitzbogen Pointed tree	1	5130 03 10170	5131 03 10170
		12	25	175	6		1	5130 03 12175	5131 03 12175
L	KEL	10	25	170	6	Rundkegel Ball nosed cone	1	5150 03 10170	5151 03 10170
		12	28	175	6		1	5150 03 12175	5151 03 12175

* Bitte reduzierte Drehzahl anwenden! Details auf Seite 458. / Please use reduced speed! Details on page 458.



Sortimente Hartmetall Frässtifte Kreuzverzahnung Z3-X, Schaft 6 mm Assortments carbide rotary burrs cross-toothing Z3-X, shank 6 mm



R3



R5



R10



RK10

BC Boxen / BC Boxes

Bezeichnung Description	Teile Pieces	Inhalt Content	Artikel-Nr. Part-No.
R3	3	1x B · D · G, Ø 10 mm Z3-X	5900 13 30003
R5	5	1x B · C · D · F · G, Ø 10 mm Z3-X	5900 13 30006
R10	10	1x B · C · F · G, Ø 6 + 12 mm Z3-X	5900 13 30011
RK10	10	1x B · C · F · G, Ø 10 + 12 mm Z3-X 1x D · L, Ø 12 mm Z3-X	5900 13 30012
R3 TiALN	3	1x B · D · G, Ø 10 mm Z3-X	5901 13 30003
R5 TiALN	5	1x B · C · D · F · G, Ø 10 mm Z3-X	5901 13 30006
R10 TiALN	10	1x B · C · F · G, Ø 6 + 12 mm Z3-X	5901 13 30011
RK10 TiALN	10	1x B · C · F · G, Ø 10 + 12 mm Z3-X 1x D · L, Ø 12 mm Z3-X	5901 13 30012



R3 TiALN



R10 TiALN

Sortiment Hartmetall Frässtifte Feinverzahnung Z5, Schaft 6 mm Assortment carbide rotary burrs fine toothing Z5, shank 6 mm

BC Boxen / BC Boxes

Bezeichnung Description	Teile Pieces	Inhalt Content	Artikel-Nr. Part-No.
R5-F	5	1x B · C · D · F · G, Ø 10 mm Z5	5905 13 30005



Sortimente Hartmetall Frässtifte ALU-Verzahnung, Schaft 3 + 6 mm Assortments carbide rotary burrs ALU-toothing, shank 3 + 6 mm

BC Boxen / BC Boxes (3 mm)

Bezeichnung Description	Teile Pieces	Inhalt Content	Artikel-Nr. Part-No.
KF10-ALU	10	1x B · C · D · F · G, Ø 3 + 6 mm Z-ALU	5903 13 30010



BC Boxen / BC Boxes (6 mm)

Bezeichnung Description	Teile Pieces	Inhalt Content	Artikel-Nr. Part-No.
R3 ALU	3	1x B · C · F, Ø 12 mm Z-ALU	5903 13 30003
R5 ALU	5	1x B · F, Ø 6 + 12 mm Z-ALU 1x C, Ø 12 mm Z-ALU	5903 13 30005



R3 ALU



R5 ALU



Display für Hartmetall Frässtifte mit 6 mm Schaft
Display for carbide rotary burrs with 6 mm shank



RD 36



RD 36 TiALN

Bestückung 36 Frässtifte Vorschlag Nr. 1
Content 36 burrs proposal No. 1



Form Shape	DIN 8033	Ø mm Kopf / Head	Bezeichnung Description		Z3-X	Z3-X TiALN
					RD 36	
					RD 36 TiALN	
B	ZYAS	6	Zylinder Stirnverzahnung	2	5100 03 06100	5101 03 06100
		6	Cylinder endcut	2	5100 03 06150	5101 03 06150
		8	Cylinder endcut	2	5100 03 08170	5101 03 08170
C	WRC	6	Walzenrund	2	5110 03 00600	5111 03 00600
		10	Ball nosed cylinder	2	5110 03 01000	5111 03 01000
		12	Ball nosed cylinder	2	5110 03 01200	5111 03 01200
D	KUD	6	Kugel	2	5115 03 00600	5116 03 00600
		10	Ball	2	5115 03 01000	5116 03 01000
		12	Ball	2	5115 03 01200	5116 03 01200
F	RBF	6	Rundbogen	2	5125 03 00600	5126 03 00600
		10	Nosed tree	2	5125 03 01000	5126 03 01000
		12	Nosed tree	2	5125 03 01200	5126 03 01200
G	SPG	6	Spitzbogen	2	5130 03 00600	5131 03 00600
		10	Pointed tree	2	5130 03 01000	5131 03 01000
		12	Pointed tree	2	5130 03 01200	5131 03 01200
L	KEL	6	Rundkegel	2	5150 03 00600	5151 03 00600
		10	Ball nosed cone	2	5150 03 01000	5151 03 01000
		12	Ball nosed cone	2	5150 03 01200	5151 03 01200

Sie wollen eine andere Bestückung? Obiges Display kann nach Ihrem Bedarf bestückt werden. Wir erstellen Ihnen gerne ein individuelles Angebot. Bitte fragen Sie an (maximale Länge 75 mm).

You want a different content? Above display can be filled with burrs according to your request. We would be pleased to provide you with an individual offer. Please ask for it (max. length 75 mm).











Ohne Frässtifte / Without burrs

Bezeichnung Description	Teile Pieces	Inhalt Content	Artikel-Nr. Part-No.
RD 36 leer	36	Frässtifte 6 mm Schaft / Rotary burrs 6 mm shank Maße / Dimension: 230 x 180 x 188 mm	0130 15 00009

HM FRÄSSTIFTE
CARBIDE ROTARY BURRS

SCHMIERSTOFFE
LUBRICANTS



		Bezeichnung Description	Code	Seite Page
Schmierstoffe / Lubricants				
		ALLROUND Schneidpaste ALLROUND cutting paste	9690 BP-20 BP-40 BP-120 BP-750	320
		HIGH PERFORMANCE Schneidwachs HIGH PERFORMANCE cutting wax	9690 BW-300	321
		HIGH PERFORMANCE Schneidgel HIGH PERFORMANCE cutting gel	9690 BG-120	322
		ALLROUND Schneidöl ALLROUND cutting oil	9690 BO-250	323
		HIGH PERFORMANCE Schneidschaum HIGH PERFORMANCE cutting foam	9690 BS-400	324

ALLROUND Schneidpaste
ALLROUND cutting paste



Code **BP-20**



Code **BP-40**

P			M	K	N	
1.1 – 2.1	3.1 – 4.1	5.1	1.1 – 4.1	1.1 – 4.2	1.1 – 1.6	2.1 – 2.6

Schneidpaste zum Bohren, Senken, Gewinden, Reiben, Sägen, Drehen und Fräsen.

- Höhere Schnittgeschwindigkeiten
- Längere Standzeit
- Sehr gute Oberflächengüte
- Gute Haftung am Werkzeug
- Hohe Schmierwirkung
- Chlor- und Silikonfrei

Cutting paste for drilling, countersinking, thread cutting, reaming, sawing, turning and milling.

- Higher cutting speeds
- Longer tool life
- Very good surface quality
- Good adhesion on tool
- High level of lubrication
- Chlorine-free and silicon-free

Bezeichnung Description	Inhalt Content		Artikel-Nr. Part-No.
BP-20	20 ml	1	9690 15 00017
BP-40	40 ml	1	9690 15 00018



Code **BP-120**



Code **BP-750**

Bezeichnung Description	Inhalt Content		Artikel-Nr. Part-No.
BP-120	120 g	1	9690 15 00019
BP-750	750 g	1	9690 15 00020



Für alle angebotenen Schmierstoffe/Schneidöle erhalten Sie auf Anfrage das entsprechende DIN Sicherheitsdatenblatt (DIN 52900).

The corresponding safety data sheet (DIN 52900) for all offered lubricants/cutting oils is available on request.





HIGH PERFORMANCE Schneidwachs
HIGH PERFORMANCE cutting wax



Code **BW-300**

1.1 - 2.1		P 3.1 - 4.1		5.1		M 1.1 - 4.1		K 1.1 - 4.2		N 1.1 - 1.6		2.1 - 2.6	
-----------	--	----------------	--	-----	--	----------------	--	----------------	--	----------------	--	-----------	--

Schneidwachs zum Bohren, Senken, Gewinden, Reiben, Sägen, Drehen und Fräsen.

- Höhere Schnittgeschwindigkeiten
- Längere Standzeit
- Sehr gute Oberflächengüte
- Gute Haftung am Werkzeug
- Hohe Schmierwirkung
- Chlor- und Silikonfrei

Cutting wax for drilling, countersinking, thread cutting, reaming, sawing, turning and milling.

- Higher cutting speeds
- Longer tool life
- Very good surface quality
- Good adhesion on tool
- High level of lubrication
- Chlorine-free and silicon-free

Bezeichnung Description	Inhalt Content		Artikel-Nr. Part-No.
BW-300	300 g	1	9690 15 00021



SCHMIERSTOFFE
LUBRICANTS



Für alle angebotenen Schmierstoffe/Schneidöle erhalten Sie auf Anfrage das entsprechende DIN Sicherheitsdatenblatt (DIN 52900).

The corresponding safety data sheet (DIN 52900) for all offered lubricants/cutting oils is available on request.

HIGH PERFORMANCE Schneidgel HIGH PERFORMANCE cutting gel



Code **BG-120**

P			M	K	N	
1.1 – 2.1	3.1 – 4.1	5.1	1.1 – 4.1	1.1 – 4.2	1.1 – 1.6	2.1 – 2.6

Speziell entwickeltes HIGH PERFORMANCE Schneidgel zum Bohren, Senken, Gewinden, Reiben, Sägen, Drehen und Fräsen.

- Höhere Schnittgeschwindigkeiten
- Längere Standzeit
- Sehr gute Oberflächengüte
- Gute Haftung am Werkzeug
- Chlor- und Schwermetallfrei

Besonders für INOX geeignet.

Special HIGH PERFORMANCE cutting gel for drilling, counter-sinking, thread cutting, reaming, sawing, turning and milling.

- Higher cutting speeds
- Longer tool life
- Very good surface quality
- Good adhesion on tool
- Chlorine-free and free of heavy metals

Especially suitable for stainless steel.

Bezeichnung Description	Inhalt Content		Artikel-Nr. Part-No.
BG-120	120 ml	1	9690 15 00022



Für alle angebotenen Schmierstoffe/Schneidöle erhalten Sie auf Anfrage das entsprechende DIN Sicherheitsdatenblatt (DIN 52900).

The corresponding safety data sheet (DIN 52900) for all offered lubricants/cutting oils is available on request.



ALLROUND Schneidöl
ALLROUND cutting oil



Code **BO-250**

P		M		K		N	
1.1 - 2.1	3.1 - 4.1	5.1	1.1 - 4.1	1.1 - 4.2	1.1 - 1.6	2.1 - 2.6	

Schneidöl zum Bohren, Senken, Gewinden, Reiben, Sägen, Drehen und Fräsen.

- Höhere Schnittgeschwindigkeiten
- Längere Standzeit
- Sehr gute Oberflächengüte
- Verhindert Aufbauschneiden
- Minimalmengenschmierung
- Chlor- und Mineralölfrei
- Basiert auf natürlichen Rohstoffen

Cutting oil for drilling, countersinking, thread cutting, reaming, sawing, turning and milling.

- Higher cutting speeds
- Longer tool life
- Very good surface quality
- Prevents build up edges
- Minimum quantity lubrication
- Chlorine-free and mineral oil free
- Based on natural raw materials

Bezeichnung Description	Inhalt Content		Artikel-Nr. Part-No.
BO-250	250 ml	1	9690 15 00023



SCHMIERSTOFFE
LUBRICANTS



Für alle angebotenen Schmierstoffe/Schneidöle erhalten Sie auf Anfrage das entsprechende DIN Sicherheitsdatenblatt (DIN 52900).

The corresponding safety data sheet (DIN 52900) for all offered lubricants/cutting oils is available on request.

HIGH PERFORMANCE Schneidschaum HIGH PERFORMANCE cutting foam



Code **BS-400**

P			M	K	N	
1.1 – 2.1	3.1 – 4.1	5.1	1.1 – 4.1	1.1 – 4.2	1.1 – 1.6	2.1 – 2.6

Speziell entwickelter HIGH PERFORMANCE Schaum zum Bohren, Senken, Gewinden, Reiben, Sägen, Drehen und Fräsen.

- Höhere Schnittgeschwindigkeiten
- Längere Standzeit
- Sehr gute Oberflächengüte
- Gute Haftung am Werkzeug (tropft nicht)
- Kein Verharzen
- Mineral- und Silikonfrei
- **Mit Wasser abwaschbar**

Special HIGH PERFORMANCE cutting foam for drilling, countersinking, thread cutting, reaming, sawing, turning and milling.

- Higher cutting speeds
- Longer tool life
- Very good surface quality
- Good adhesion on tool (no dripping)
- No gumming
- Mineral oil free and silicone-free
- **Washable with water**

Bezeichnung Description	Inhalt Content		Artikel-Nr. Part-No.
BS-400	400 ml	1	9690 15 00024



Für alle angebotenen Schmierstoffe/Schneidöle erhalten Sie auf Anfrage das entsprechende DIN Sicherheitsdatenblatt (DIN 52900).

The corresponding safety data sheet (DIN 52900) for all offered lubricants/cutting oils is available on request.























- **Bohren - Senken - Gewindeschneiden**
- **Nachschliff**
- **Umschliff aus Lagerware**
- **Sonderanfertigung nach Zeichnung**
- **Beschichtungsservice**

- **Drilling - Countersinking - Threading**
- **Resharpening**
- **Regrinding of stock items**
- **Special production according to drawing**
- **Coating service**



	DIN	Bezeichnung Description	Code	Seite Page
Bohrfutter und Zubehör / Drill chucks and accessories				
		Zahnkranz-Bohrfutter Key type drill chucks	1465 1466	328
		Schlüssellose Bohrfutter Keyless drill chucks	1467 – 1469	329 – 330
		Präzisions-Schnellspannbohrfutter Precision Quick-Action drill chucks	1458 1459	331
		Winkelbohrvorrichtung PRO 100 L-shaped driver heavy duty PRO 100	6351	426
		Zubehör für Bohrfutter Accessories for drill chucks	1465	329
		238 Kegeldorne Drill chuck arbors	1463	332
		2185 Reduzierhülsen Reduction sleeves	1460	332
		2187 Verlängerungshülsen Extension sleeves	1461	333
		317 Austreiber Drill drifts	1462	333

Zahnkranz-Bohrfutter Key type drill chucks



Code 1465



- Lieferung mit Schlüssel
- Nicht schlagbohrfest
- Mit Gewindeaufnahme
- Einsatz auf Netzbohrmaschine

- Delivery with key
- For rotary use only
- With female thread
- Application on corded drilling machines

Ø d1 mm	Aufnahme Mount	Schlüssel Key	Ø d2 mm	L mm		Artikel-Nr. Part-No.
1,5 - 10	1/2" x 20 UNF	S2	34	48	1	1465 03 01012
1,5 - 13	1/2" x 20 UNF	S2	42	59	1	1465 03 01312

Zahnkranz-Bohrfutter PRO Key type drill chucks PRO

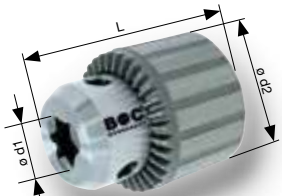

Code 1466



- Lieferung mit Schlüssel
- Schlagbohrfest
- Mit Gewindeaufnahme oder Konusaufnahme
- Einsatz auf Akku-, Netz- und Ständerbohrmaschine

- Delivery with key
- Impact resistant
- With female thread or conical mount
- Application on cordless, corded and stationary drilling machines

Ø d1 mm	Aufnahme Mount	Schlüssel Key	Ø d2 mm	L mm		Artikel-Nr. Part-No.
Gewindeaufnahme / Female thread						
1,0 - 10	1/2" x 20 UNF	S2	38	50	1	1466 03 01012
2,0 - 13	1/2" x 20 UNF	S8	53	66	1	1466 03 01312
Konusaufnahme / Conical mount						
1,0 - 13	B16	S3	53	66	1	1466 03 01316
1,0 - 16	B16	S3	53	66	1	1466 03 01616

Schlüssel für Zahnkranzbohrfutter Keys for key type drill chucks

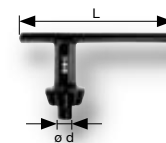

Code 1465-SK

· Schlüssel für Zahnkranzbohrfutter

· Keys for key type drill chucks

Größe Size	Ø d mm	L mm		Artikel-Nr. Part-No.
S2	6,0	80	10	1465 16 00002
S3	8,0	85	1	1465 16 00003

Adapter SDS-plus für Bohrfutter Adaptor SDS-plus for drill chucks



- Mit 1/2" x 20 UNF Gewinde
- **Nur drehend einsetzbar!**

- With 1/2" x 20 UNF mount
- **For rotary use only!**



Code 1465-SDS

Für Gewinde For thread	Schaft Shank	L mm		Artikel-Nr. Part-No.
1/2" x 20 UNF	SDS-plus	63	1	1465 16 00012

Schlüssellose Bohrfutter Keyless drill chucks



- Schlüssellos
- Kunststoffhülse
- Nicht schlagbohrfest
- Mit Gewindeaufnahme
- Einsatz auf Akku- und Netzbohrmaschinen

- Keyless
- Plastic-sleeve
- For rotary use only
- With female thread
- Application on corded and cordless drilling machines



Code 1467

Ø d1 mm	Aufnahme Mount	Ø d2 mm	L mm		Artikel-Nr. Part-No.
0,8 – 10	3/8" x 24 UNF	42	54	1	1467 03 01038
2,0 – 13	1/2" x 20 UNF	43	63	1	1467 03 01312

Schnellspanbohrfutter "Auto-Lock" Kunststoffhülse Quick-Action drill chucks "Auto-Lock" plastic-sleeve



Code 1468



- Schlüssellos
- Mit Spannkraftsicherung
- Kunststoffhülse
- Schlagbohrfest
- Mit Gewindeaufnahme
- Einsatz auf Akku- und Netzbohrmaschinen

- Keyless
- With clamping force safety device
- Plastic-sleeve
- Impact resistant
- With female thread
- Application on corded and cordless drilling machines

Ø d1 mm	Aufnahme Mount	Ø d2 mm	L mm		Artikel-Nr. Part-No.
0,8 – 10	1/2" x 20 UNF	42	54	1	1468 03 01012
1,5 – 13	1/2" x 20 UNF	43	63	1	1468 03 01312

Schnellspanbohrfutter "Auto-Lock" Metallhülse Quick-Action drill chuck "Auto-Lock" metal-sleeve



Code 1469



- Schlüssellos
- Mit Spannkraftsicherung
- Stabile Metallhülse
- Schlagbohrfeste Ausführung
- Mit Gewindeaufnahme
- Einsatz auf Akku- und Netzbohrmaschinen

- Keyless
- With clamping force safety device
- Stable metal-sleeve
- Impact resistant
- With female thread
- Application on corded and cordless drilling machines

Ø d1 mm	Aufnahme Mount	Ø d2 mm	L mm		Artikel-Nr. Part-No.
1,5 – 13	1/2" x 20 UNF	42	65	1	1469 03 01312

Schnellspannbohrfutter PRO Quick-Action drill chucks PRO



Code 1458



- Schnelles spannen und verriegeln
- Selbsttätiges Nachspannen
- Stabile Metallhülse
- Mit Innenkegel
- Einsatz auf Ständerbohrmaschinen

- Quick clamping and locking
- Automatic retightening
- Stable metal-sleeve
- With taper mount
- Application on stationary drilling machines

Ø d1 mm	Aufnahme Mount	Rundlauf mm Concentricity mm	Ø d2 mm	L mm		Artikel-Nr. Part-No.
1,0 – 13	B16	0,25	44	97	1	1458 03 01316
1,0 – 16	B16	0,25	48	108	1	1458 03 01616
1,0 – 16	B18	0,25	48	108	1	1458 03 01618

Präzisions-Schnellspannbohrfutter HD Precision Quick-Action drill chucks HD



- Industrierausführung Typ HD
- Hohe Rundlaufgenauigkeit
- Schnelles spannen und verriegeln
- Selbsttätiges Nachspannen
- Stabile Metallhülse
- Mit Innenkegel
- Einsatz auf Werkzeugmaschinen und Ständerbohrmaschinen

- Industrial version type HD
- High concentricity
- Quick clamping and locking
- Automatic retightening
- Stable metal-sleeve
- With taper mount
- Application on machine tools and stationary drilling machines.



Code 1459

Ø d1 mm	Aufnahme Mount	Rundlauf mm Concentricity mm	Ø d2 mm	L mm		Artikel-Nr. Part-No.
0,2 – 13	B16	0,12	44	97	1	1459 03 01316
0,2 – 16	B16	0,12	48	108	1	1459 03 01616
0,2 – 16	B18	0,12	48	108	1	1459 03 01618

Kegeldorne DIN 238
Drill chuck arbors DIN 238



Code 1463



Ganz gehärtet und geschliffen zur Aufnahme von Bohrfuttern auf Maschinen mit Morsekegelaufnahme.

Fully hardened and milled for using chucks on machines with Morse taper attachment.

MK MT	B	L 1 mm		Artikel-Nr. Part-No.
1	B 10	86	1	1463 03 00110
1	B 12	90	1	1463 03 00112
1	B 16	97	1	1463 03 00116
2	B 10	101	1	1463 03 00210
2	B 12	105	1	1463 03 00212
2	B 16	112	1	1463 03 00216
2	B 18	120	1	1463 03 00218
3	B 12	124	1	1463 03 00312
3	B 16	131	1	1463 03 00316
3	B 18	139	1	1463 03 00318
4	B 16	156	1	1463 03 00416
4	B 18	164	1	1463 03 00418

KEGELDORNE & REDUZIERHÜLSEN
DRILL CHUCKS ARBORS & REDUCTION SLEEVES

Reduzierhülsen DIN 2185
Reduction sleeves DIN 2185

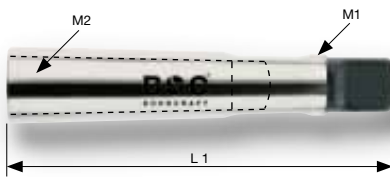

Code 1460



Ganz gehärtet, zum Ausgleich unterschiedlicher Morsekegel an Maschine und Werkzeug.

Fully hardened, for tools with Morse taper shanks.

M1 (MK / MT)	M2 (MK / MT)	L 1 mm		Artikel-Nr. Part-No.
2	1	92	1	1460 03 00021
3	1	99	1	1460 03 00031
3	2	112	1	1460 03 00032
4	1	124	1	1460 03 00041
4	2	124	1	1460 03 00042
4	3	140	1	1460 03 00043
5	3	156	1	1460 03 00053
5	4	171	1	1460 03 00054

Verlängerungshülsen DIN 2187
Extension sleeves DIN 2187

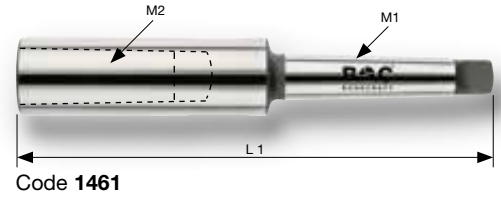

Code 1461



Ganz gehärtet, zum Ausgleich unterschiedlicher Morsekegel an Maschine und Werkzeug. Fully hardened, for tools with Morse taper shanks.

M1 (MK / MT)	M2 (MK / MT)	L 1 mm		Artikel-Nr. Part-No.
1	1	145	1	1461 03 00011
1	2	160	1	1461 03 00012
1	3	181	1	1461 03 00013
2	1	160	1	1461 03 00021
2	2	175	1	1461 03 00022
2	3	196	1	1461 03 00023
2	4	221	1	1461 03 00024
3	1	175	1	1461 03 00031
3	2	194	1	1461 03 00032
3	3	215	1	1461 03 00033
3	4	240	1	1461 03 00034
4	1	200	1	1461 03 00041
4	2	210	1	1461 03 00042
4	3	240	1	1461 03 00043
4	4	265	1	1461 03 00044
4	5	300	1	1461 03 00045

Austreiber DIN 317
Drill drifts DIN 317

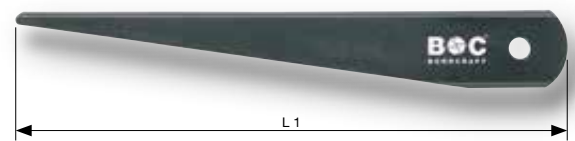

Code 1462

Ganz gehärtet, für Werkzeugkegel DIN 228 -1 B.





























Fully hardened, for Morse taper shanks according DIN 228-1 B.

Für Morsekonus (MK) For taper shanks (MT)	L 1 mm		Artikel-Nr. Part-No.
1 + 2	140	1	1462 07 00012
3	190	1	1462 07 00003
4	225	1	1462 07 00004
5 + 6	265	1	1462 07 00056



STEIN- UND BETONBOHRER
MASONRY AND CONCRETE DRILL BITS



	Typ Type	Bezeichnung Description	Code	Seite Page
Schlag- und Drehbohrer / Percussion and rotary drill bits				
 		Steinbohrer HM, Standardausführung Masonry drill bits, standard version	2100 2150	336
 		Schlagbohrer HM Percussion drill bits, TCT	2260 2261	337
 	LASER	Premium Betonbohrer HM Premium concrete drill bits, TCT	2250 – 2252	338
 	GRANIT	Granitbohrer HM Granite drill bits, TCT	2280	339
 	MULTI-LASER	Mehrzweckbohrer / Fliesenbohrer, HM Multi-Purpose / Ceramic drills, TCT	2270	340
 		Glas- und Fliesenbohrer HM Glass and ceramic drill bits, TCT	2700	341
 	T4	Glas- und Fliesenbohrer, 4 HM-Schneiden Glass / Ceramic drill bits, 4 carbide cutting edges	2710	341
Hammerbohrer / Hammer drill bits				
 	QX-4	Hammerbohrer SDS-plus, 4-Schneiden, Vollhartmetallkopf, PGM-Prüfzeichen Hammer drill bits SDS-plus, 4 cutting edges, full carbide head, PGM certification-mark	2612	344 – 346
 	4-X	Hammerbohrer SDS-plus, 4 HM-Schneiden Hammer drill bits SDS-plus, 4 carbide cutting edges	2615	347 – 348
 	X-TREME	Hammerbohrer SDS-plus, 2 HM-Schneiden, PGM Prüfzeichen Hammer drill bits SDS-plus, 2 carbide cutting edges, PGM certification-mark	2610	349 – 351
 		Hammerbohrer SDS-plus, 2 HM-Schneiden Hammer drill bits SDS-plus, 2 carbide cutting edges	2590	352 – 353
 		Hammerbohrer SDS-max, PGM-Prüfzeichen Hammer drill bits SDS-max, PGM certification-mark	2620	354 – 355
Meißel / Chisels				
 	 	Meißel SDS-plus / Meißel SDS-max Chisels SDS-plus / Chisels SDS-max	2650 2660	356 – 357

Steinbohrer HM, Standardausführung Masonry drill bits TCT, standard version

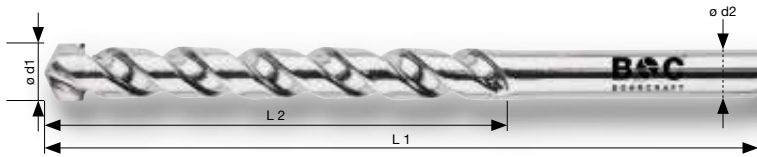

Code 2100 • 2150

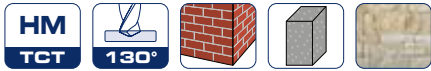

Basic Steinbohrer mit stabiler Hartmetallplatte für einfache Bohrarbeiten in Beton, Mauerwerk und Naturstein.

Basic masonry drill bit with stable carbide plate for simple drilling operations in concrete, masonry and natural stone.

Ø d1 mm	Ø d1 Zoll / inch	L 1 mm	L 2 mm	Ø d2 mm		Artikel-Nr. Part-No.
3,0	1/8"	70	42	2,8	1	2100 07 00300
4,0	5/32"	75	45	3,2	1	2100 07 00400
5,0	3/16"	85	51	4,2	1	2100 07 00500
5,5	7/32"	85	51	4,2	1	2100 07 00550
6,0	15/64"	100	60	5,2	1	2100 07 00600
6,5	1/4"	100	60	5,2	1	2100 07 00650
7,0	9/32"	100	60	5,2	1	2100 07 00700
8,0	5/16"	120	72	6,2	1	2100 07 00800
10,0	3/8"	120	72	8,2	1	2100 07 01000
11,0	7/16"	150	90	9,5	1	2100 07 01100
12,0	15/32"	150	90	9,5	1	2100 07 01200
13,0	1/2"	150	90	9,5	1	2100 07 01300
14,0	9/16"	150	90	10,0	1	2100 07 01400
16,0	5/8"	160	96	10,0	1	2100 07 01600
6,0	15/64"	150	90	5,2	1	2150 07 00600
8,0	5/16"	200	120	6,2	1	2150 07 00800
10,0	3/8"	200	120	8,2	1	2150 07 01000
12,0	15/32"	200	120	9,5	1	2150 07 01200
14,0	9/16"	200	120	10,0	1	2150 07 01400

Kunststoff-Kassetten / Plastic-Boxes

Bezeichnung Description	Teile Pieces	Inhalt Content	Display 	Artikel-Nr. Part-No.
S 410	5	Ø 4 · 5 · 6 · 8 · 10 mm	18	2100 14 30005
S 80	8	Ø 3 · 4 · 5 · 6 · 7 · 8 · 9 · 10 mm	16	2100 14 30008



S 410



S 80



Display S 410

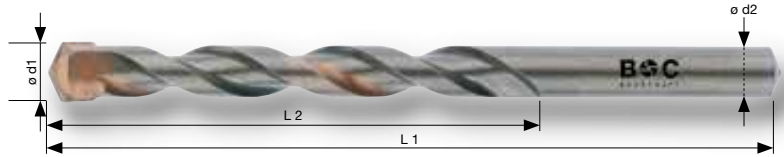

Code 2260 • 2261



Schlagbohrer mit stabiler Hartmetallplatte und gefräster Bohrerspirale für professionelle Bohrarbeiten in Beton, Mauerwerk und Naturstein.

Percussion drill bit with stable carbide plate and milled flute for professional drilling operations in concrete, masonry and natural stone.

Ø d1 mm	Ø d1 Zoll / inch	L 1 mm	L 2 mm	Ø d2 mm		Artikel-Nr. Part-No.		Artikel-Nr. Part-No.
4,0	5/32"	75	40	3,6	1	2260 07 00400	10	2260 03 00400
5,0	3/16"	85	50	4,5	1	2260 07 00500	10	2260 03 00500
6,0	15/64"	100	60	5,5	1	2260 07 00600	10	2260 03 00600
6,5	1/4"	100	60	6,0	1	2260 07 00650	-	-
7,0	9/32"	100	60	6,5	1	2260 07 00700	10	2260 03 00700
8,0	5/16"	120	80	7,0	1	2260 07 00800	10	2260 03 00800
10,0	3/8"	120	80	9,0	1	2260 07 01000	10	2260 03 01000
12,0	15/32"	150	90	10,0	1	2260 07 01200	5	2260 03 01200
14,0	9/16"	150	90	10,0	1	2260 07 01400	-	-
16,0	5/8"	150	90	10,0	1	2260 07 01600	-	-
5,0	3/16"	150	90	4,5	1	2261 07 00500	-	-
6,0	15/64"	150	90	5,4	1	2261 07 00600	-	-
6,5	1/4"	150	90	6,0	1	2261 07 00650	-	-
8,0	5/16"	200	135	7,0	1	2261 07 00800	-	-
10,0	3/8"	200	135	9,0	1	2261 07 01000	-	-
12,0	15/32"	200	135	10,0	1	2261 07 01200	-	-
14,0	9/16"	200	135	10,0	1	2261 07 01400	-	-
16,0	5/8"	200	135	10,0	1	2261 07 01600	-	-
8,0	5/16"	400	300	7,0	1	2261 07 00840	-	-
10,0	3/8"	400	300	9,0	1	2261 07 01040	-	-
12,0	15/32"	400	300	10,0	1	2261 07 01240	-	-
14,0	9/16"	400	300	10,0	1	2261 07 01440	-	-
16,0	5/8"	400	300	10,0	1	2261 07 01640	-	-

BC Multi-Pack / BC Multi-Pack

Bezeichnung Description	Teile Pieces	Inhalt Content	Artikel-Nr. Part-No.
SP 3 HM	3	Ø 5 · 6 · 8 mm	2260 13 30003
SP 5 HM	5	Ø 4 · 5 · 6 · 8 · 10 mm	2260 13 30005



SP 3 HM



SP 5 HM



SCHLAGBOHRER
PERCUSSION DRILL BITS

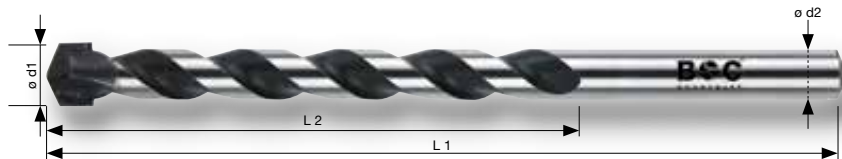

Code 2250 • 2251 • 2252



Beton- und Beton-Mauerbohrer. Hochtemperaturgelötete Hartmetallplatte, gefräste Nut und überschlifene Oberfläche. Für professionelle Bohrarbeiten und lange Lebensdauer in Beton, Mauerwerk und Naturstein.

Concrete and concrete masonry drill bit. High-temperature brazed carbide plate, milled flute and ground surface. For professional drilling operations and a long tool life in concrete, masonry and natural stone.

Ø d1 mm	Ø d1 Zoll / inch	L 1 mm	L 2 mm	Ø d2 mm		Artikel-Nr. Part-No.		Artikel-Nr. Part-No.
3,0	1/8"	70	35	2,9	1	2250 07 00300	-	-
4,0	5/32"	75	40	3,5	1	2250 07 00400	10	2250 03 00400
5,0	3/16"	85	50	4,5	1	2250 07 00500	10	2250 03 00500
5,5	7/32"	85	50	5,1	1	2250 07 00550	-	-
6,0	15/64"	100	60	5,4	1	2250 07 00600	10	2250 03 00600
6,5	1/4"	100	60	5,9	1	2250 07 00650	-	-
7,0	9/32"	100	60	6,1	1	2250 07 00700	-	-
8,0	5/16"	120	80	7,0	1	2250 07 00800	10	2250 03 00800
9,0	11/32"	120	80	8,0	1	2250 07 00900	-	-
10,0	3/8"	120	80	8,4	1	2250 07 01000	10	2250 03 01000
12,0	15/32"	150	90	10,0	1	2250 07 01200	-	-
13,0	1/2"	150	90	10,0	1	2250 07 01300	-	-
14,0	9/16"	150	90	10,0	1	2250 07 01400	-	-
16,0	5/8"	150	90	10,0	1	2250 07 01600	-	-
5,0	3/16"	150	90	4,5	1	2251 07 00500	-	-
5,5	7/32"	150	90	5,1	1	2251 07 00550	-	-
6,0	15/64"	150	90	5,4	1	2251 07 00600	-	-
6,5	1/4"	150	90	5,9	1	2251 07 00650	-	-
8,0	5/16"	200	140	7,0	1	2251 07 00800	-	-
10,0	3/8"	200	140	8,4	1	2251 07 01000	-	-
12,0	15/32"	200	140	10,0	1	2251 07 01200	-	-
14,0	9/16"	200	140	10,0	1	2251 07 01400	-	-
6,0	15/64"	400	340	5,4	1	2252 07 00600	-	-
8,0	5/16"	400	340	7,0	1	2252 07 00800	-	-
10,0	3/8"	400	340	8,4	1	2252 07 01000	-	-
12,0	1/2"	400	340	10,0	1	2252 07 01200	-	-
14,0	9/16"	400	340	10,0	1	2252 07 01400	-	-
16,0	5/8"	400	340	10,0	1	2252 07 01600	-	-
18,0	11/16"	400	340	13,0	1	2252 07 01800	-	-
20,0	25/32"	400	340	13,0	1	2252 07 02000	-	-

Kunststoff-Kassetten / Plastic-Boxes

Bezeichnung Description	Teile Pieces	Inhalt Content	Display	Artikel-Nr. Part-No.
SL 410	5	Ø 4 · 5 · 6 · 8 · 10 mm	18	2250 14 30005
SL 80	8	Ø 3 · 4 · 5 · 6 · 7 · 8 · 9 · 10 mm	16	2250 14 30008



BC Multi-Pack / BC Multi-Pack

Bezeichnung Description	Teile Pieces	Inhalt Content	Artikel-Nr. Part-No.
SL 3	3	Ø 5 · 6 · 8 mm	2250 13 30003



Granitbohrer HM DIN 8039 / ISO 5468
 Granite drill bits TCT DIN 8039 / ISO 5468

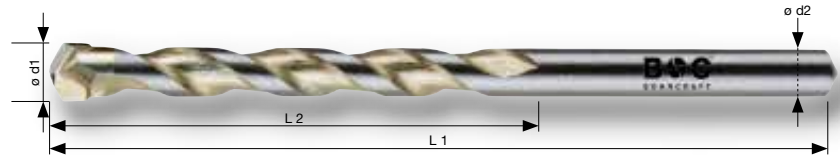

Code **2280**



Granitbohrer mit diamantgeschliffener Hartmetallplatte. Geeignet für harten Naturstein wie Granit, Marmor, Schiefer sowie Mauerwerk und Porenbeton.

Granite drill bit with diamond-ground carbide plate. Suitable for hard natural stone such as granite, marble, slate as well as masonry and aerated concrete.

Ø d1 mm	Ø d1 Zoll / inch	L 1 mm	L 2 mm	Ø d2 mm		Artikel-Nr. Part-No.
5	3/16"	85	50	4,6	1	2280 07 00500
6	15/64"	100	60	5,4	1	2280 07 00600
7	9/32"	100	60	6,5	1	2280 07 00700
8	5/16"	120	80	7,0	1	2280 07 00800
10	3/8"	120	80	9,0	1	2280 07 01000
12	15/32"	150	90	10,0	1	2280 07 01200

BC Multi-Pack / BC Multi-Pack

Bezeichnung Description	Teile Pieces	Inhalt Content	Artikel-Nr. Part-No.
SG 4	4	Ø 5 · 6 · 8 · 10 mm	2280 13 30004



SG 4



GRANITBOHRER
GRANITE DRILL BITS

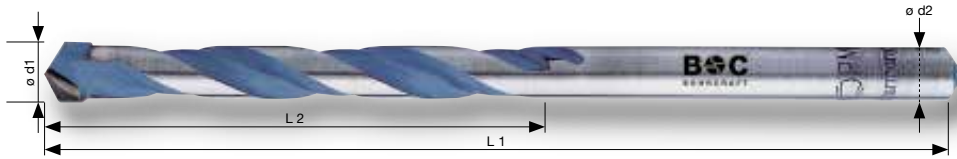

Code 2270

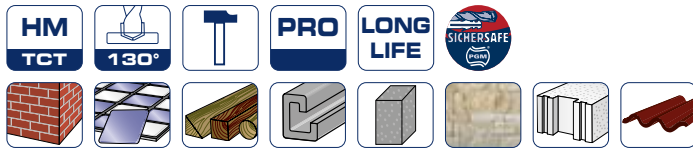

Mehrzweckbohrer für fast alle Materialien, wie z. B. Fliesen und Keramik (bis Ritzhärte 8), Beton, Mauerwerk, Holz, Metall, Kunststoff und Dachziegel. Robuster Bohrkopf mit innovativer Hartmetallplatte und mehrfach diamantgeschliffenen Hartmetallschneidkanten.

Multi-Purpose drill bit for application in nearly any materials e. g. tiles and ceramic (up to Mohs-hardness 8), concrete, wood, steel, plastics and roof tiles. Robust drill bit head with new designed carbide plate and multiple diamond-ground cutting edges.

Ø d1 mm	Ø d1 Zoll / inch	L 1 mm	L 2 mm	Ø d2 mm		Artikel-Nr. Part-No.		Artikel-Nr. Part-No.
3,0	1/8"	70	40	2,8	1	2270 07 00300	-	-
4,0	5/32"	75	40	3,8	1	2270 07 00400	10	2270 03 00400
5,0	3/16"	85	50	4,5	1	2270 07 00500	10	2270 03 00500
5,5	7/32"	85	50	4,5	1	2270 07 00550	-	-
6,0	15/64"	100	60	5,5	1	2270 07 00600	10	2270 03 00600
6,5	1/4"	100	60	5,5	1	2270 07 00650	-	-
7,0	9/32"	100	60	6,5	1	2270 07 00700	-	-
8,0	5/16"	120	80	7,2	1	2270 07 00800	10	2270 03 00800
9,0*	11/32"	120	80	8,0	1	2270 07 00900	-	-
10,0	3/8"	120	80	9,0	1	2270 07 01000	10	2270 03 01000
12,0	15/32"	150	90	10,0	1	2270 07 01200	-	-
6,0	15/64"	150	90	5,5	1	2270 07 00615	-	-
6,5	1/4"	150	90	5,5	1	2270 07 00615	-	-
7,0*	9/32"	150	90	6,5	1	2270 07 00715	-	-
6,0	15/64"	250	200	5,5	1	2270 07 00625	-	-
6,5	1/4"	250	200	5,5	1	2270 07 00625	-	-
8,0	5/16"	250	200	7,2	1	2270 07 00825	-	-
10,0	3/8"	250	200	9,0	1	2270 07 01025	-	-
12,0*	15/32"	250	200	10,0	1	2270 07 01225	-	-

* Nur solange Vorrat reicht / * Only as long as stock last

BC Industrie-Kassette / BC Metal-Box

Bezeichnung Description	Teile Pieces	Inhalt Content	Artikel-Nr. Part-No.
UMK 412	7	Ø 4 · 5 · 6 · 6 · 8 · 10 · 12 mm	2270 13 10007



Kunststoff-Kassette / Plastic-Box

Bezeichnung Description	Teile Pieces	Inhalt Content	Display	Artikel-Nr. Part-No.
UM 410	5	Ø 4 · 5 · 6 · 8 · 10 mm	18	2270 14 30005



BC Multi-Pack / BC Multi-Pack

Bezeichnung Description	Teile Pieces	Inhalt Content	Artikel-Nr. Part-No.
UM 3	3	Ø 5 · 6 · 8 mm	2270 13 30003



MEHRZWECKBOHRER MULTI-PURPOSE DRILL BITS

Glasbohrer / Fliesenbohrer T4, mit 4 HM-Schneiden Glass / Ceramic drill bits T4, with 4 carbide cutting edges



Code 2710

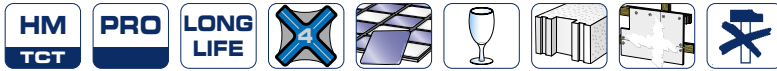

Spezialbohrer mit 4 HM-Schneiden. Zum Bohren von Glas, Flaschen, Porzellan und Fliesen. Ausreichende Kühlung mit Wasser, Terpentin, oder Petroleum erhöht die Lebensdauer.
Ebenso geeignet für Porenbeton, Rigips, etc.

Special drill with 4 carbide cutting edges. For drilling glass, bottles, porcelain and tiles. Sufficient cooling with water, turpentine or petroleum increases tool life.
Also suitable for aerated concrete, plasterboard, etc.

Ø d mm	L 1 mm		Artikel-Nr. Part-No.
5	75	1	2710 07 00500
6	80	1	2710 07 00600
8	85	1	2710 07 00800
10	90	1	2710 07 01000
12	95	1	2710 07 01200

BC Multi-Pack / BC Multi-Pack

Bezeichnung Description	Teile Pieces	Inhalt Content	Artikel-Nr. Part-No.
GM-T4	4	Ø 5 · 6 · 8 · 10 mm	2710 13 30004



★★★★★ Glasbohrer / Fliesenbohrer HM Glass / Ceramic drill bits TCT



Zum Bohren von Glas, Porzellan, Fliesen, Keramik etc. Niedrige Drehzahl einstellen und ausreichend mit Wasser, Essig, Terpentin oder Petroleum kühlen.
Nur drehend einsetzbar!

Special drill for glass, porcelain, tiles, ceramics etc. Low drilling-speed and sufficient cooling with water, vinegar, turpentine and petroleum recommended.
For rotary use only!





















Code 2700

Ø d mm	L 1 mm		Artikel-Nr. Part-No.
3	58	1	2700 07 00300
4	58	1	2700 07 00400
5	58	1	2700 07 00500
6	58	1	2700 07 00600
8	78	1	2700 07 00800
10	98	1	2700 07 01000
12	98	1	2700 07 01200

BC Multi-Pack / BC Multi-Pack





















Bezeichnung Description	Teile Pieces	Inhalt Content	Artikel-Nr. Part-No.
GM-5	5	Ø 4 · 5 · 6 · 8 · 10 mm	2700 13 30005



	Schneiden Cutting edges	Qualität Quality
	4	<div style="text-align: right;">   </div> <p>Code 2612 • QX-4 (Seite / Page 345 – 346)</p> 
	4	<div style="text-align: right;">  </div> <p>Code 2615 • 4-X (Seite / Page 347 – 348)</p> 
	2	<div style="text-align: right;">   </div> <p>Code 2610 • X-TREME (Seite / Page 349 – 351)</p> 
	2	<div style="text-align: right;">  </div> <p>Code 2590 • BASIC (Seite / Page 352 – 353)</p> 
	4	<div style="text-align: right;">   </div> <p>Code 2620 (Seite / Page 354 – 355)</p> 



TECHNISCHE DETAILS
TECHNICAL DETAILS

Bezeichnung Description	Spirale Flute	 Beton armiert Reinforced concrete	 Beton Concrete	 Mauerwerk Masonry	 Naturstein Natural stone
Hammerbohrer der Spitzenklasse mit 4-Schneiden Voll-Hartmetallkopf. Abmessungsbereich: 5 – 32 mm Top-class hammer drill bits with 4 cutting edges, full carbide head. Drill range: 5 – 32 mm					
Hammerbohrer mit X-förmigem 4-Schneiden Bohrkopf. Abmessungsbereich: 5 – 30 mm Hammer drill bits with 4-carbide cutting edges arranged in X-shape. Drill range: 5 – 30 mm					
Erstklassiger Hammerbohrer mit 4-fach Spirale und Zentrierspitze. Abmessungsbereich: 3,5 – 26 mm High-class hammer drill bits with 4-fold flute and centering tip. Drill range: 3,5 – 26 mm					
Hammerbohrer für preisbewusste Anwender. Abmessungsbereich: 4 – 26 mm Economic hammer drill bits. Drill range: 4 – 26 mm					
Hammerbohrer der Spitzenklasse mit 4-Schneiden ab 16 mm. Bis 15 mm mit 2 HM-Schneiden. Abmessungsbereich: 12 – 50 mm Top-class hammer drill bits with 4 cutting edges, from 16 mm. Up to 15 mm with 2 carbide cutting edges. Drill range: 12 – 50 mm					

 geeignet / suitable
  empfohlen / recommended





Code 2612

Besonders zum Bohren in armierten Beton geeignet!
Especially suitable for drilling in reinforced concrete!

4-Schneiden Vollhartmetallkopf

Speziell entwickelter Bohrkopf mit 4 Hartmetallschneiden für optimale Kraftübertragung und schnellen Bohrfortschritt. Kein Verhaken in armiertem Beton. Die Zentrierspitze sorgt für punktgenaues Anbohren ohne zu verlaufen.

4-cutting with solid carbide head

Special designed drill head with 4 carbide cutting edges for optimum power transmission and fast drilling progress. No jamming if reinforced concrete will be hit. The centering point ensures precise drilling without slipping.

**4-fach Spirale**

Große Eingangsnuten in Kombination mit der 4-fach-Wendelung ergeben einen perfekten Abtransport des Bohrmehls aus dem Bohrloch. Des Weiteren gewährleistet das 4-spiralige Design hohe Laufruhe sowie eine optimale Führung des Bohrers. Kernverstärkung für hohe Bruchstabilität und optimale Übertragung der Schlagenergie.

4-fold flute

Large entry grooves in combination with 4-fold flute for a perfect removal of the drilling dust. Furthermore the 4-flute design ensures very smooth running and optimal guidance of the drill. Reinforced core for high fracture stability and optimum transmission of impact energy.

**PGM-Prüfzeichen**

PGM zertifizierte Bohrer garantieren passgenaue und exakte Löcher. Hohe Qualitätsstandards und regelmäßige Kontrollen sorgen für die Einhaltung genauester Bohrtoleranzen.

PGM test mark

PGM certified drills guarantee exact and precise holes. High quality standards and regular inspections ensure the compliance of exact drill tolerances.





Hammerbohrer SDS-plus **QX-4**, mit Voll-Hartmetallkopf, PGM-Prüfzeichen
 Hammer drill bits SDS-plus **QX-4**, with solid carbide head, PGM certification-mark



Code 2612



Ø d mm	L 1 mm	L 2 mm		Artikel-Nr. Part-No.		Artikel-Nr. Part-No.
5,0	110	50	1	2612 05 05011	10	2612 09 05011
5,0	160	100	1	2612 05 05016	10	2612 09 05016
5,0	210	150	1	2612 05 05021	-	-
6,0	110	50	1	2612 05 06011	10	2612 09 06011
6,0	160	100	1	2612 05 06016	10	2612 09 06016
6,0	210	150	1	2612 05 06021	10	2612 09 06021
6,0	260	200	1	2612 05 06026	10	2612 09 06026
6,5	160	100	1	2612 05 06516	10	2612 09 06516
6,5	210	150	1	2612 05 06521	10	2612 09 06521
6,5	260	200	1	2612 05 06526	10	2612 09 06526
6,5	310	250	1	2612 05 06531	-	-
8,0	110	50	1	2612 05 08011	10	2612 09 08011
8,0	160	100	1	2612 05 08016	10	2612 09 08016
8,0	210	150	1	2612 05 08021	10	2612 09 08021
8,0	260	200	1	2612 05 08026	10	2612 09 08026
8,0	310	250	1	2612 05 08031	-	-
8,0	460	400	1	2612 05 08046	-	-
10,0	160	100	1	2612 05 10016	10	2612 09 10016
10,0	210	150	1	2612 05 10021	10	2612 09 10021
10,0	260	200	1	2612 05 10026	10	2612 09 10026
10,0	310	250	1	2612 05 10031	5	2612 09 10031
10,0	460	400	1	2612 05 10046	-	-
10,0	600	540	1	2612 05 10060	-	-
12,0	160	100	1	2612 05 12016	10	2612 09 12016
12,0	210	150	1	2612 05 12021	5	2612 09 12021
12,0	260	200	1	2612 05 12026	5	2612 09 12026
12,0	310	250	1	2612 05 12031	5	2612 09 12031
12,0	450	400	1	2612 05 12045	-	-
12,0	600	540	1	2612 05 12060	-	-
14,0	160	100	1	2612 05 14016	5	2612 09 14016
14,0	210	150	1	2612 05 14021	5	2612 09 14021
14,0	260	200	1	2612 05 14026	5	2612 09 14026
14,0	310	250	1	2612 05 14031	-	-
14,0	450	400	1	2612 05 14045	-	-
14,0	600	540	1	2612 05 14060	-	-
16,0	160	100	1	2612 05 16016	-	-
16,0	210	150	1	2612 05 16021	-	-
16,0	260	200	1	2612 05 16026	-	-
16,0	450	400	1	2612 05 16045	-	-
16,0	600	540	1	2612 05 16060	-	-
18,0	250	200	1	2612 05 18025	-	-
18,0	450	400	1	2612 05 18045	-	-
20,0	250	200	1	2612 05 20025	-	-
20,0	450	400	1	2612 05 20045	-	-
22,0	250	200	1	2612 05 22025	-	-
22,0	450	400	1	2612 05 22045	-	-
24,0	250	200	1	2612 05 24025	-	-
24,0	450	400	1	2612 05 24045	-	-
25,0	250	200	1	2612 05 25025	-	-
25,0	450	400	1	2612 05 25045	-	-



HAMMERBOHRER
HAMMER DRILL BITS



Code 2612



Ø d mm	L 1 mm	L 2 mm		Artikel-Nr. Part-No.		Artikel-Nr. Part-No.
28,0	250	200	1	2612 05 28025	-	-
28,0	450	400	1	2612 05 28045	-	-
30,0	450	400	1	2612 05 30045	-	-
32,0	450	400	1	2612 05 32045	-	-

Bei einer Arbeitslänge ab 400 mm muss mit kurzem Bohrer gleichen Durchmessers, mindestens 150 mm vorgebohrt werden!
For a working length of 400 mm and more pre-drilling with the same diameter minimum 150 mm is essential!

BC Industrie-Kassette / BC Metal-Box

Bezeichnung Description	Teile Pieces	Inhalt Content	Artikel-Nr. Part-No.
HB 7 QX-4	7	Ø 5 · 6 · 8 x 110 mm + 6 · 8 · 10 · 12 x 160 mm	2612 14 10007

BC Multi-Pack / BC Multi-Pack

Bezeichnung Description	Teile Pieces	Inhalt Content	Artikel-Nr. Part-No.
HB 3 QX-4	3	Ø 6 · 8 · 10 x 160 mm	2612 13 30003
HB 5 QX-4	5	Ø 5 · 6 x 110 mm + 6 · 8 · 10 x 160 mm	2612 13 30005
HB 7-2 QX-4	7	Ø 5 · 6 · 8 x 110 mm + 6 · 8 · 10 · 12 x 160 mm	2612 13 30007

BC Quadro Pack / BC Quadro Pack

Bezeichnung Description	Teile Pieces	Inhalt Content	Artikel-Nr. Part-No.
HB 8 QX-4	8	Ø 6 · 8 · 10 · 12 x 160 mm + 8 · 10 x 210 mm + Meißel / Chisel Spitz / Point 250 mm · Flach / Flat 20 x 250 mm	2612 03 00008



HB 7QX-4



HB 5 QX-4



HB 8 QX-4

Hammerbohrer SDS-plus 4-X, mit 4 HM-Schneiden Hammer drill bits SDS-plus 4-X, with 4 carbide cutting edges

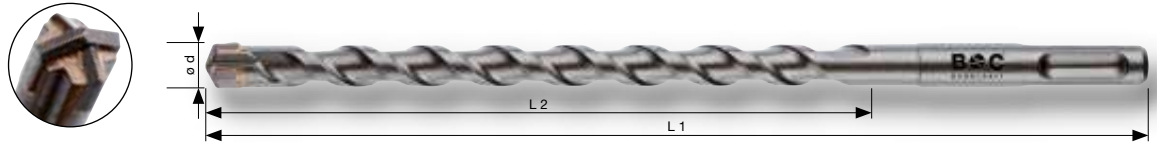

Code **2615**



Basic Hammerbohrer mit 4-Schneiden und 2-fach Spirale.
Robuste Hartmetallschneiden in X-Form für alle normalen
Bohrarbeiten in Beton, Mauerwerk und Naturstein.

Basic hammer drill bit with 4 cutting edges and 2 flutes.
Robust X-shaped carbide cutting edges for all normal drilling
operations in concrete, masonry and natural stone.

Ø d mm	L 1 mm	L 2 mm		Artikel-Nr. Part-No.
5,0	110	50	1	2615 05 05011
5,0	160	100	1	2615 05 05016
5,5	160	100	1	2615 05 05516
6,0	110	50	1	2615 05 06011
6,0	160	100	1	2615 05 06016
6,0	210	150	1	2615 05 06021
6,0	260	200	1	2615 05 06026
6,5	160	100	1	2615 05 06516
6,5	210	150	1	2615 05 06521
6,5	260	200	1	2615 05 06526
6,5	450	400	1	2615 05 06545
8,0	110	50	1	2615 05 08011
8,0	160	100	1	2615 05 08016
8,0	210	150	1	2615 05 08021
8,0	260	200	1	2615 05 08026
8,0	450	400	1	2615 05 08045
10,0	160	100	1	2615 05 10016
10,0	210	150	1	2615 05 10021
10,0	260	200	1	2615 05 10026
10,0	450	400	1	2615 05 10045
12,0	160	100	1	2615 05 12016
12,0	210	150	1	2615 05 12021
12,0	260	200	1	2615 05 12026
12,0	450	400	1	2615 05 12045
14,0	160	100	1	2615 05 14016
14,0	210	150	1	2615 05 14021
14,0	260	200	1	2615 05 14026
14,0	450	400	1	2615 05 14045
15,0	160	100	1	2615 05 15016
15,0	260	200	1	2615 05 15026
16,0	160	100	1	2615 05 16016
16,0	250	200	1	2615 05 16025
16,0	450	400	1	2615 05 16045
18,0	250	200	1	2615 05 18025
18,0	450	400	1	2615 05 18045
20,0	250	200	1	2615 05 20025
20,0	450	400	1	2615 05 20045
22,0	250	200	1	2615 05 22025
22,0	450	400	1	2615 05 22045
24,0	250	200	1	2615 05 24025
24,0	450	400	1	2615 05 24045
25,0	250	200	1	2615 05 25025
25,0	450	400	1	2615 05 25045

HAMMERBOHRER
HAMMER DRILL BITS

Hammerbohrer SDS-plus 4-X, mit 4 HM-Schneiden Hammer drill bits SDS-plus 4-X, with 4 carbide cutting edges

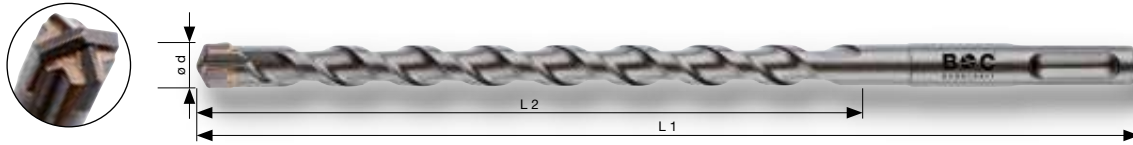

Code 2615

Ø d mm	L 1 mm	L 2 mm		Artikel-Nr. Part-No.
28,0	450	400	1	2615 05 28045
30,0	450	400	1	2615 05 30045

Bei einer Arbeitslänge ab 400 mm muss mit kurzem Bohrer gleichen Durchmessers (mindestens 150 mm) vorgebohrt werden!
For a working length of 400 mm and more pre-drilling with the same diameter (minimum 150 mm) is essential!

BC Industrie-Kassette / BC Metal-Box

Bezeichnung Description	Teile Pieces	Inhalt Content	Artikel-Nr. Part-No.
HB 7-4X	7	Ø 5 · 6 · 8 x 110 mm + 6 · 8 · 10 · 12 x 160 mm	2615 14 10007

BC Multi-Pack / BC Multi-Pack

Bezeichnung Description	Teile Pieces	Inhalt Content	Artikel-Nr. Part-No.
HB3 4-X	3	Ø 6 · 8 · 10 x 160 mm	2615 13 30003
HB5 4-X	5	Ø 5 · 6 x 110 mm + 6 · 8 · 10 x 160 mm	2615 13 30005
HB7-2 4-X	7	Ø 5 · 6 · 8 x 110 mm + 6 · 8 · 10 · 12 x 160 mm	2615 13 30007



HB 7-4X



HB3 4-X



HB5 4-X

Hammerbohrer SDS-plus X-TREME, mit PGM-Prüfzeichen Hammer drill bits SDS-plus X-TREME, with PGM certification-mark

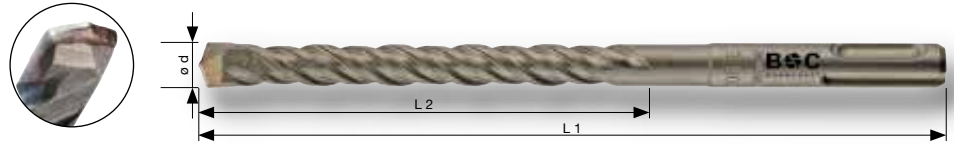



Code 2610



Premium Hammerbohrer mit 2-Schneiden und Zentrierspitze. Die optimierte 4-fach Spirale sorgt in Kombination mit großen Eingangsnuten für den perfekten Abtransport des Bohrmehls. Der PGM zertifizierte Bohrer garantiert passgenaue und exakte Löcher bei langer Lebensdauer.

First class hammer drill bit with 2 cutting edges and centering tip. The optimized 4-fold flute, in combination with large entry grooves, ensures that the drilling dust is perfectly removed. PGM certified drills guarantee exact and precise holes together with a long tool life.

Ø d mm	L 1 mm	L 2 mm		Artikel-Nr. Part-No.		Artikel-Nr. Part-No.
3,5	110	50	1	2610 05 03511	-	-
4,0	110	50	1	2610 05 04011	-	-
4,0	160	100	1	2610 05 04016	-	-
5,0	110	50	1	2610 05 05011	10	2610 09 05011
5,0	160	100	1	2610 05 05016	10	2610 09 05016
5,0	210	150	1	2610 05 05021	-	-
5,5	110	50	1	2610 05 05501	10	2610 09 05511
5,5	160	100	1	2610 05 05516	10	2610 09 05516
6,0	110	50	1	2610 05 06011	10	2610 09 06011
6,0	160	100	1	2610 05 06016	10	2610 09 06016
6,0	210	150	1	2610 05 06021	10	2610 09 06021
6,0	260	200	1	2610 05 06026	10	2610 09 06026
6,0	460	400	1	2610 05 06046	-	-
6,5	110	50	1	2610 05 06511	10	2610 09 06511
6,5	160	100	1	2610 05 06516	10	2610 09 06516
6,5	210	150	1	2610 05 06521	10	2610 09 06521
6,5	260	200	1	2610 05 06526	10	2610 09 06526
6,5	310	250	1	2610 05 06531	-	-
7,0	110	50	1	2610 05 07011	-	-
7,0	160	100	1	2610 05 07016	-	-
7,0	210	150	1	2610 05 07021	-	-
8,0	110	50	1	2610 05 08011	10	2610 09 08011
8,0	160	100	1	2610 05 08016	10	2610 09 08016
8,0	210	150	1	2610 05 08021	10	2610 09 08021
8,0	260	200	1	2610 05 08026	10	2610 09 08026
8,0	310	250	1	2610 05 08031	-	-
8,0	460	400	1	2610 05 08046	-	-
8,0	600	550	1	2610 05 08061	-	-
10,0	110	50	1	2610 05 10011	10	2610 09 10011
10,0	160	100	1	2610 05 10016	10	2610 09 10016
10,0	210	150	1	2610 05 10021	10	2610 09 10021
10,0	260	200	1	2610 05 10026	10	2610 09 10026
10,0	310	250	1	2610 05 10031	5	2610 09 10031
10,0	460	400	1	2610 05 10046	-	-
10,0	600	550	1	2610 05 10061	-	-
10,0	1000	950	1	2610 05 10010	-	-
12,0	160	100	1	2610 05 12016	10	2610 09 12016
12,0	200	150	1	2610 05 12021	5	2610 09 12021
12,0	260	200	1	2610 05 12026	5	2610 09 12026
12,0	300	250	1	2610 05 12031	5	2610 09 12031
12,0	450	400	1	2610 05 12046	-	-
12,0	600	550	1	2610 05 12060	-	-
12,0	1000	950	1	2610 05 12010	-	-
14,0	160	100	1	2610 05 14016	5	2610 09 14016
14,0	200	150	1	2610 05 14021	5	2610 09 14021



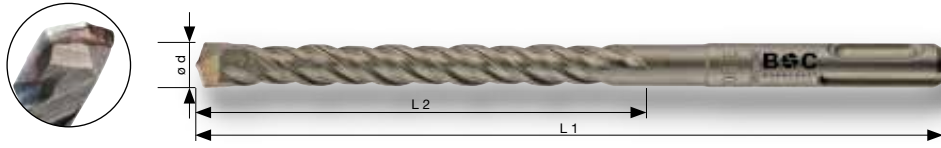

HAMMERBOHRER
HAMMER DRILL BITS

Hammerbohrer SDS-plus X-TREME, mit PGM-Prüfzeichen
 Hammer drill bits SDS-plus X-TREME, with PGM certification-mark



Code 2610

Ø d mm	L 1 mm	L 2 mm		Artikel-Nr. Part-No.		Artikel-Nr. Part-No.
14,0	260	200	1	2610 05 14026	5	2610 09 14026
14,0	300	250	1	2610 05 14031	-	-
14,0	450	400	1	2610 05 14046	-	-
14,0	600	550	1	2610 05 14060	-	-
14,0	1000	950	1	2610 05 14010	-	-
15,0	160	100	1	2610 05 15016	-	-
15,0	260	200	1	2610 05 15026	-	-
16,0	160	100	1	2610 05 16016	-	-
16,0	200	150	1	2610 05 16021	-	-
16,0	300	250	1	2610 05 16031	-	-
16,0	450	400	1	2610 05 16046	-	-
16,0	600	550	1	2610 05 16061	-	-
16,0	1000	950	1	2610 05 16010	-	-
18,0	200	150	1	2610 05 18021	-	-
18,0	250	200	1	2610 05 18025	-	-
18,0	300	250	1	2610 05 18030	-	-
18,0	450	400	1	2610 05 18045	-	-
18,0	600	550	1	2610 05 18060	-	-
18,0	1000	950	1	2610 05 18010	-	-
20,0	200	150	1	2610 05 20020	-	-
20,0	300	250	1	2610 05 20030	-	-
20,0	450	400	1	2610 05 20045	-	-
20,0	600	550	1	2610 05 20060	-	-
20,0	1000	950	1	2610 05 20010	-	-
22,0	250	200	1	2610 05 22025	-	-
22,0	450	400	1	2610 05 22045	-	-
22,0	600	550	1	2610 05 22060	-	-
22,0	1000	950	1	2610 05 22010	-	-
24,0	250	200	1	2610 05 24025	-	-
24,0	450	400	1	2610 05 24045	-	-
25,0	450	400	1	2610 05 25045	-	-
26,0	250	200	1	2610 05 26025	-	-
26,0	450	400	1	2610 05 26045	-	-

Bei einer Arbeitslänge ab 400 mm (800 mm) muss mit kurzem Bohrer gleichen Durchmessers, mindestens 150 mm (400 mm) vorgebohrt werden!
 For a working length of 400 mm (800 mm) and more pre-drilling with the same diameter minimum 150 mm (400 mm) is essential!

HAMMERBOHRER
HAMMER DRILL BITS

Hammerbohrer SDS-plus **X-TREME**, mit PGM-Prüfzeichen
 Hammer drill bits SDS-plus **X-TREME**, with PGM certification-mark

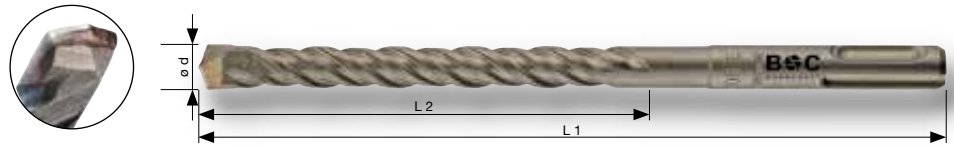

Code 2610

BC Industrie-Kassette / BC Metal-Box

Bezeichnung Description	Teile Pieces	Inhalt Content	Artikel-Nr. Part-No.
HB 7-XT	7	Ø 5 · 6 · 8 x 110 mm + 6 · 8 · 10 · 12 x 160 mm	2610 14 10007

BC Multi-Pack / BC Multi-Pack

Bezeichnung Description	Teile Pieces	Inhalt Content	Artikel-Nr. Part-No.
HB 3-XT	3	Ø 6 · 8 · 10 x 160 mm	2610 14 30003
HB 4-XT	4	Ø 5 · 6 x 110 mm + 8 · 10 x 160 mm	2610 14 30004
HB 5-XT	5	Ø 5 · 6 x 110 mm + 6 · 8 · 10 x 160 mm	2610 14 30005
HB 7-2 XT	7	Ø 5 · 6 · 8 x 110 mm + 6 · 8 · 10 · 12 x 160 mm	2610 14 30007

BC Quadro Pack / BC Quadro Pack

Bezeichnung Description	Teile Pieces	Inhalt Content	Artikel-Nr. Part-No.
HB 8-XT	8	Ø 6 · 8 · 10 · 12 x 160 mm + 8 · 10 x 210 mm + Meißel / Chisel Spitz / Point 250 mm · Flach / Flat 20 x 250 mm	2610 03 00008



HB 7-XT



HB 5-XT



HB 8-XT

Hammerbohrer SDS-plus

Hammer drill bits SDS-plus

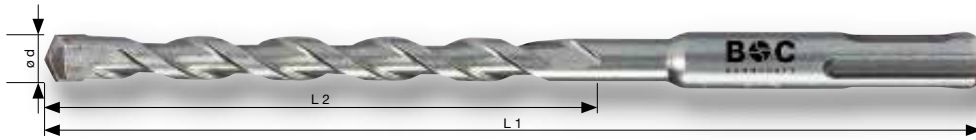

Code 2590



Basic Hammerbohrer mit 2-Schneiden und 2-fach Spirale. Stabile Hartmetallplatte für alle normalen Bohrarbeiten in Beton, Mauerwerk und Naturstein.



Basic hammer drill bit with 2 cutting edges and 2 flutes. Stable carbide plate for normal drilling operations in concrete, masonry and natural stone.

Ø d mm	L 1 mm	L 2 mm		Artikel-Nr. Part-No.		Artikel-Nr. Part-No.
4,0	110	50	1	2590 05 04011	-	-
5,0	110	50	1	2590 05 05011	10	2590 09 05011
5,0	160	100	1	2590 05 05016	10	2590 09 05016
5,5	110	50	1	2590 05 05511	-	-
5,5	160	100	1	2590 05 05516	-	-
6,0	110	50	1	2590 05 06011	10	2590 09 06011
6,0	160	100	1	2590 05 06016	10	2590 09 06016
6,0	210	150	1	2590 05 06021	10	2590 09 06021
6,0	260	200	1	2590 05 06026	10	2590 09 06026
6,5	110	50	1	2590 05 06511	-	-
6,5	160	100	1	2590 05 06516	-	-
6,5	210	150	1	2590 05 06521	-	-
6,5	260	200	1	2590 05 06526	-	-
7,0	160	100	1	2590 05 07016	-	-
8,0	110	50	1	2590 05 08011	10	2590 09 08011
8,0	160	100	1	2590 05 08016	10	2590 09 08016
8,0	210	150	1	2590 05 08021	10	2590 09 08021
8,0	260	200	1	2590 05 08026	10	2590 09 08026
8,0	310	250	1	2590 05 08031	-	-
8,0	460	400	1	2590 05 08046	-	-
10,0	110	50	1	2590 05 10011	-	-
10,0	160	100	1	2590 05 10016	10	2590 09 10016
10,0	210	150	1	2590 05 10021	10	2590 09 10021
10,0	260	200	1	2590 05 10026	10	2590 09 10026
10,0	310	250	1	2590 05 10031	5	2590 09 10031
10,0	460	400	1	2590 05 10046	-	-
10,0	600	550	1	2590 05 10060	-	-
12,0	160	100	1	2590 05 12016	10	2590 09 12016
12,0	210	150	1	2590 05 12021	5	2590 09 12021
12,0	260	200	1	2590 05 12026	5	2590 09 12026
12,0	310	250	1	2590 05 12031	5	2590 09 12031
12,0	460	400	1	2590 05 12046	-	-
12,0	600	550	1	2590 05 12060	-	-
12,0	1000	950	1	2590 05 12010	-	-
14,0	160	100	1	2590 05 14016	5	2590 09 14016
14,0	210	150	1	2590 05 14021	5	2590 09 14021
14,0	260	200	1	2590 05 14026	5	2590 09 14026
14,0	310	250	1	2590 05 14031	5	2590 09 14016
14,0	460	400	1	2590 05 14046	5	2590 09 14021
14,0	600	550	1	2590 05 14060	5	2590 09 14026
14,0	1000	950	1	2590 05 14010	-	-
15,0	160	100	1	2590 05 15016	-	-
15,0	260	200	1	2590 05 15026	-	-
16,0	160	100	1	2590 05 16016	-	-
16,0	210	150	1	2590 05 16021	-	-
16,0	300	250	1	2590 05 16030	-	-

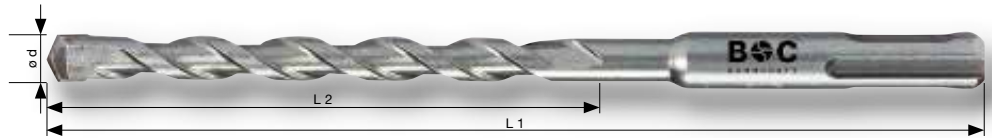
HAMMERBOHRER
HAMMER DRILL BITS



Code 2590

Ø d mm	L 1 mm	L 2 mm		Artikel-Nr. Part-No.		Artikel-Nr. Part-No.
16,0	450	400	1	2590 05 16046	-	-
16,0	600	550	1	2590 05 16060	-	-
16,0	1000	950	1	2590 05 16010	-	-
18,0	200	150	1	2590 05 18020	-	-
18,0	300	250	1	2590 05 18030	-	-
18,0	450	400	1	2590 05 18046	-	-
18,0	600	550	1	2590 05 18060	-	-
18,0	1000	950	1	2590 05 18010	-	-
20,0	200	150	1	2590 05 20020	-	-
20,0	300	250	1	2590 05 20030	-	-
20,0	450	400	1	2590 05 20046	-	-
20,0	600	550	1	2590 05 20060	-	-
20,0	1000	950	1	2590 05 20010	-	-
22,0	250	200	1	2590 05 22025	-	-
22,0	300	250	1	2590 05 22030	-	-
22,0	450	400	1	2590 05 22046	-	-
22,0	600	550	1	2590 05 22060	-	-
22,0	1000	950	1	2590 05 22010	-	-
24,0	250	200	1	2590 05 24025	-	-
24,0*	300	250	1	2590 05 24030	-	-
24,0	450	400	1	2590 05 24046	-	-
26,0*	450	400	1	2590 05 26046	-	-

* Nur solange Vorrat reicht / * Only as long as stock lasts

Bei einer Arbeitslänge ab 400 mm (800 mm) muss mit kurzem Bohrer gleichen Durchmessers, mindestens 150 mm (400 mm) vorgebohrt werden!
For a working length of 400 mm (800 mm) and more pre-drilling with the same diameter minimum 150 mm (400 mm) is essential!

BC Industrie-Kassette / BC Metal-Box

Bezeichnung Description	Teile Pieces	Inhalt Content	Artikel-Nr. Part-No.
HB 7	7	Ø 5 · 6 · 8 x 110 mm + 6 · 8 · 10 · 12 x 160 mm	2590 14 10007

BC Multi-Pack / BC Multi-Pack

Bezeichnung Description	Teile Pieces	Inhalt Content	Artikel-Nr. Part-No.
HB 3	3	Ø 6 · 8 · 10 x 160 mm	2590 14 30003
HB 4	4	Ø 5 · 6 x 110 mm + 8 · 10 x 160 mm	2590 14 30004
HB 5	5	Ø 5 · 6 x 110 mm + 6 · 8 · 10 x 160 mm	2590 14 30005
HB 7-2	7	Ø 5 · 6 · 8 x 110 mm + 6 · 8 · 10 · 12 x 160 mm	2590 14 30007



HB 7



HB 5

HAMMERBOHRER
HAMMER DRILL BITS



Code 2620



Premium Hammerbohrer mit 4 Hartmetallschneiden (≥ 16 mm) für ideale Kraftübertragung und schnellen Bohrfortschritt. Hohe Laufruhe und perfekte Führung im Bohrloch durch optimierte 4-fach Spirale. Der PGM zertifizierte Bohrer garantiert passgenaue und exakte Löcher bei langer Lebensdauer.

First class hammer drill bit with 4 carbide cutting edges (≥ 16 mm) for ideal power transmission and fast drilling progress. Smooth running and perfect guidance in the drill hole due to the optimized 4-fold flute. PGM certified drills guarantee exact and precise holes together with a long tool life.

Ø d mm	L 1 mm	L 2 mm		Artikel-Nr. Part-No.
12	340	200	1	2620 03 12034
12	540	400	1	2620 03 12054
12	740	600	1	2620 03 12069
14	340	200	1	2620 03 14034
14	540	400	1	2620 03 14054
15	340	200	1	2620 03 15034
15	540	400	1	2620 03 15054
16	340	200	1	2620 03 16034
16	540	400	1	2620 03 16054
18	340	200	1	2620 03 18034
18	540	400	1	2620 03 18054
18	940	800	1	2620 03 18094
20	340	200	1	2620 03 20032
20	540	400	1	2620 03 20052
20	920	800	1	2620 03 20092
22	340	200	1	2620 03 22032
22	540	400	1	2620 03 22052
22	920	800	1	2620 03 22092
24	340	200	1	2620 03 24032
24	540	400	1	2620 03 24052
25	340	200	1	2620 03 25032
25	540	400	1	2620 03 25052
25	920	800	1	2620 03 25092
25	1320	1200	1	2620 03 25132
28	380	250	1	2620 03 28037
28	570	450	1	2620 03 28057
28	670	550	1	2620 03 28067
30	320	200	1	2620 03 30037
30	570	450	1	2620 03 30057
32	380	250	1	2620 03 32037
32	570	450	1	2620 03 32057
32	920	800	1	2620 03 32092
32	1320	1200	1	2620 03 32132
35	370	250	1	2620 03 35037
35	570	450	1	2620 03 35057
35	670	550	1	2620 03 35067
38	370	250	1	2620 03 38037
38	570	450	1	2620 03 38057

HAMMERBOHRER
HAMMER DRILL BITS

Hammerbohrer SDS-max **PRO**, PGM-Prüfzeichen
 Hammer drill bits SDS-max **PRO**, PGM certification-mark



Code **2620**

Ø d mm	L 1 mm	L 2 mm		Artikel-Nr. Part-No.
40	370	250	1	2620 03 40037
40	570	450	1	2620 03 40057
40	920	800	1	2620 03 40092
40	1320	1200	1	2620 03 40132
45	570	450	1	2620 03 45057
50	570	450	1	2620 03 50057

Bei einer Arbeitslänge ab 400 mm (800 mm) muss mit kurzem Bohrer gleichen Durchmessers, mindestens 150 mm (400 mm) vorgebohrt werden!
 For a working length of 400 mm (800 mm) and more pre-drilling with the same diameter minimum 150 mm (400 mm) is essential!





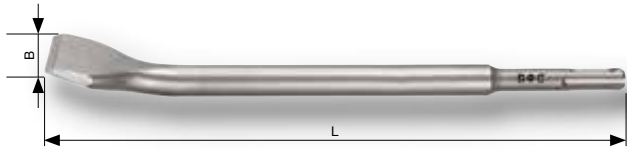



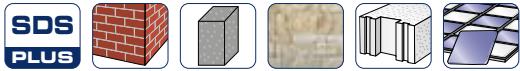

HAMMERBOHRER
 HAMMER DRILL BITS



Code 2650







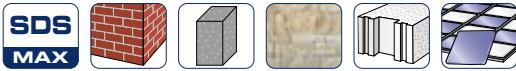
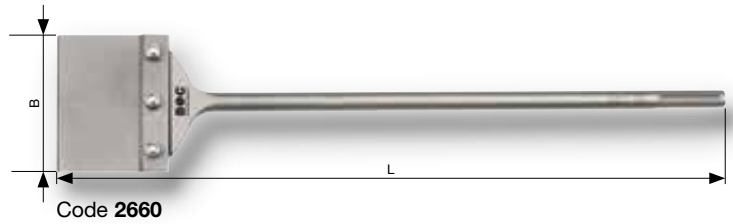

Ausführung Version		L mm	B mm		Artikel-Nr. Part-No.		Artikel-Nr. Part-No.
	Spitzmeißel Point-Chisel	250	-	1	2650 05 00025	10	2650 15 00025
	Flachmeißel Flat-Chisel	250	20	1	2650 05 02025	10	2650 15 02025
	Spatmeißel Spade-Chisel	250	40	1	2650 05 04020	10	2650 15 04020
	Hohlmeißel Hollow-Chisel	250	22	1	2650 05 02224	-	-
	Fliesenmeißel Tile-Chisel	250	40	1	2650 05 04025	-	-
	Spachtelmeißel Floor Scraper	250	100	1	2650 05 10025	-	-
	Ersatzspachtel Replacement Scraper	102	100	1	2650 15 00001	-	-

Meißelsortiment SDS-plus / Chisels assortment SDS-plus

Bezeichnung Description	Teile Pieces	Inhalt Content		Artikel-Nr. Part-No.
M3-plus	3	Spitz / Point 250 mm Flach / Flat 20 x 250 mm Spat / Spade 40 x 250 mm	1	2650 03 00003



























Ausführung Version		L mm	B mm		Artikel-Nr. Part-No.		Artikel-Nr. Part-No.
	Spitzmeißel Point-Chisel	280	-	1	2660 05 00028	-	-
		400	-	1	2660 05 00040	10	2660 15 00040
		600	-	1	2660 05 00600	-	-
	Flachmeißel Flat-Chisel	280	25	1	2660 05 02428	-	-
		400	25	1	2660 05 02440	10	2660 15 02440
		600	25	1	2660 05 02060	-	-
	Spatmeißel Spade-Chisel	400	50	1	2660 05 05036	10	2660 15 05036
		300	80	1	2660 05 08030	-	-
	Hohlmeißel Hollow-Chisel	300	26	1	2660 05 02630	-	-
	Fliesenmeißel Tile-Chisel	300	50	1	2660 05 05030	-	-
	Spachtelmeißel Floor Scraper	600	125	1	2660 05 12560	-	-
	Ersatzspachtel Replacement Scraper	102	125	1	2660 15 00001	-	-

Meißelsortiment SDS-max / Chisels assortment SDS-max

Bezeichnung Description	Teile Pieces	Inhalt Content		Artikel-Nr. Part-No.
M3-max	3	Spitz / Point 400 mm Flach / Flat 25 x 400 mm Spat / Spade 50 x 400 mm	1	2660 03 00003





	Typ Type	Bezeichnung Description	Code	Seite Page
Diamantbohrer / Diamond drill bits				
 	DIAMANT M14	Diamant-Fliesenbohrer M14 für Winkelschleifer Diamond tile drill bits M14 for angle grinders	2702	360
 	DIAMANT	Diamant-Fliesenbohrer mit 6-kant Schaft Diamond tile drill bits with hex-shank	2701	361
 	BASIC	Diamant-Fliesenbohrer mit 3-Flächenschaft Diamond tile drill bits with triangle-shank	2703	362
 		Zubehör für Diamantbohrer Accessories for diamond drill bits	2701	363
Diamant-Dosensenker / Diamond core drills				
 	PROFI	Diamant-Dosensenker Diamond core drills	2720	364
 		Zubehör für Diamant-Dosensenker Accessories for diamond core drills	2301 2302	364
Diamant-Trennscheiben / Diamond cutting tools				
 	PROFI	Diamant-Trennscheiben TURBO mit Kühllöchern Diamond cutting discs TURBO, with cooling slots	2730	366
 	BASIC	Diamant-Trennscheiben TURBO Diamond cutting discs TURBO	2735	366
 	BASIC	Diamant-Trennscheiben Diamond cutting discs	2740	367
 	PROFI	Diamant-Trennscheiben CERAMIC Diamond cutting discs CERAMIC	2745	367
Diamantschleifteller / Diamond cup wheels				
 	PROFI	Diamant-Schleifteller Diamond cup wheels	2750	368

DIAMANT-Fliesenbohrer mit M14 Gewinde für Winkelschleifer

DIAMOND Tile drills with M14 thread for angle grinders

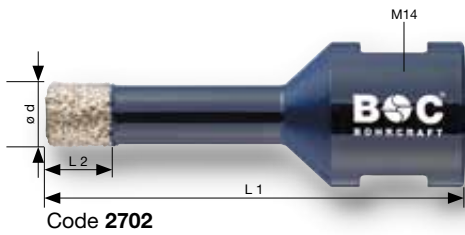

DIAMANT



Spezialbohrer zum Trockenbohren von extrem harten Fliesen, wie z.B. Feinsteinzeug, Porzellan, Marmor, Granit, Keramik. **Bis Ø 15 mm mit Kühlwachs gefüllt. Bei längerem Bohren ab 30 Sekunden, müssen kurze Kühlpausen gemacht werden! Nur drehend einsetzbar!**

Special drill for dry cutting of extremely hard tiles, for example: stoneware, porcelain, marble, granite, ceramic. **Up to size Ø 15 mm filled with cooling-wax. After drilling 30 seconds it is necessary to have a short cooling break. For rotary use only!**

Ø d mm	L 1 mm	L 2 mm	Nutzlänge mm Working length mm	Gewinde Thread		Artikel-Nr. Part-No.
mit Kühlwachs / with cooling wax						
6	63	10	35	M14	1	2702 03 00600
8	63	10	35	M14	1	2702 03 00800
10	63	10	35	M14	1	2702 03 01000
12	63	10	35	M14	1	2702 03 01200
14	63	10	35	M14	1	2702 03 01400
15	63	10	35	M14	1	2702 03 01500
ohne Kühlwachs / without cooling wax						
20	63	15	40	M14	1	2702 03 02000
25	63	15	40	M14	1	2702 03 02500
30	63	15	40	M14	1	2702 03 03000
35	63	15	40	M14	1	2702 03 03500
40	63	15	40	M14	1	2702 03 04000
43	63	15	40	M14	1	2702 03 04300
45	63	15	40	M14	1	2702 03 04500
50	63	15	40	M14	1	2702 03 05000
55	63	15	40	M14	1	2702 03 05500
57	63	15	40	M14	1	2702 03 05700
60	63	15	40	M14	1	2702 03 06000
68	63	15	40	M14	1	2702 03 06800
70	63	15	40	M14	1	2702 03 07000
80	63	15	40	M14	1	2702 03 08000
100	63	15	40	M14	1	2702 03 10000
110	63	15	40	M14	1	2702 03 11000
120	63	15	40	M14	1	2702 03 12000

6-kant Adapter / Hexagon adaptor

Code	Bezeichnung Description		Artikel-Nr. Part-No.
AD-M14	6-kant Adapter SW 8,5 mm für M14 Diamant Fliesenbohrer Hexagon adaptor SW 8,5 mm for M14 diamond tile drills	1	2702 03 00001

BC Boxen / BC Boxes

Bezeichnung Description	Teile Pieces	Inhalt Content	Artikel-Nr. Part-No.
DB 4-2	4	Ø 35 · 40 · 50 · 68 mm	2702 13 30004
DB 7	7	2x Ø 6 · 2x Ø 8 · 1x Ø 10 · 1x Ø 12 · 1x Ø 14 mm	2702 13 30007

Runddose / Round-Box

Bezeichnung Description	Teile Pieces	Inhalt Content	Artikel-Nr. Part-No.
DB 4	4	2x Ø 6 · 1x Ø 8 · 1x Ø 10 mm	2702 14 30004



DIAMANT-Fliesenbohrer mit 6-kant Schaft (SW 8,3)
DIAMOND Tile drills with hex-shank (SW 8,3)

DIAMANT 



Code 2701



Spezialbohrer für extrem harte Fliesen, wie z.B. Feinsteinzeug, Porzellan, Marmor, Granit, Keramik und Terracotta. Bis Ø 15 mm mit Kühlwachs gefüllt, dadurch zur Trockenbearbeitung geeignet. Darüber hinaus immer mit Wasser kühlen, damit die Langlebigkeit des Werkzeugs gewährleistet ist. Bei längerem Bohren ab 30 Sekunden, müssen kurze Kühlpausen gemacht werden! Nur drehend einsetzbar!

Special drill for extremely hard tiles, for example: stoneware, porcelain, marble, granite, ceramic and terracotta. Up to Ø 15 mm filled with cooling-wax for dry cutting. For bigger sizes cooling with water is essential in order to guarantee a long tool life. After drilling 30 seconds it is necessary to have a short cooling break. For rotary use only!

Ø d mm	L 1 mm	L 2 mm	Nutzlänge mm Working length mm	mm		Artikel-Nr. Part-No.
mit Kühlwachs / with cooling wax						
5	67	10	32	8,3	1	2701 03 00500
6	67	10	32	8,3	1	2701 03 00600
8	80	10	32	8,3	1	2701 03 00800
10	80	10	40	8,3	1	2701 03 01000
12	80	10	40	8,3	1	2701 03 01200
14	80	10	40	8,3	1	2701 03 01400
15	80	10	40	8,3	1	2701 03 01500
ohne Kühlwachs / without cooling wax						
17	90	10	40	8,3	1	2701 03 01700
20	90	10	40	8,3	1	2701 03 02000
22	90	10	40	8,3	1	2701 03 02200
25	90	10	40	8,3	1	2701 03 02500
30	90	10	40	8,3	1	2701 03 03000
35	90	10	40	8,3	1	2701 03 03500
40	90	10	40	8,3	1	2701 03 04000
50	90	10	40	8,3	1	2701 03 05000
55	90	10	40	8,3	1	2701 03 05500
65	90	10	40	8,3	1	2701 03 06500
70	90	10	40	8,3	1	2701 03 07000

BC Multi-Pack / BC Multi-Pack

Bezeichnung Description	Teile Pieces	Inhalt Content	Artikel-Nr. Part-No.
DKB 3	3	Ø 6 · 8 · 10 mm	2701 13 30003



Wichtig: Ab Ø 17mm mit Wasser kühlen, da ohne Kühlung die Lebensdauer auf 10 % der normalen Standzeit verringert wird! Empfohlene Drehzahl 1500/2000 U/Min. Nur drehend einsetzen!
Hinweis: Bei netzbetriebenen Geräten muss ein FI-/PRCD-Schutzschalter eingesetzt werden!

Important: From size 17 mm always cool with water because without cooling the tool life would be reduced to 10 % of the normal lifetime! Recommended drilling speed 1500/2000 rpm.
 Rotary use only!

Comment: For line-powered machines a FI-/PRCD-connector must be used!



DIAMANT-Fliesenbohrer BASIC mit 3-Flächenschaft (9,5 mm)

DIAMOND Tile drills BASIC with triangle-shank (9,5 mm)



Code 2703

DIAMANT



Nassbohrer für harte Fliesen wie Feinsteinzeug, Porzellan, Marmor, Granit, Keramik. **Immer mit Wasser kühlen, damit die Langlebigkeit des Werkzeugs gewährleistet ist.**

Special drill for wet cutting in hard tiles like stoneware, porcelain, marble, granite, ceramic. **Cooling with water is essential in order to guarantee a long tool life.**

Ø d1 mm	L 1 mm	L 2 mm	Nutzlänge mm Working length mm	Ø d2 mm		Artikel-Nr. Part-No.
5	53	4	35	9,5	1	2703 03 00500
6	53	4	35	9,5	1	2703 03 00600
8	53	4	35	9,5	1	2703 03 00800
10	53	4	35	9,5	1	2703 03 01000
12	53	4	35	9,5	1	2703 03 01200
25	53	4	35	9,5	1	2703 03 02500

Runddose / Round-Box

Bezeichnung Description	Teile Pieces	Inhalt Content	Artikel-Nr. Part-No.
DB 6	6	2x Ø 6 · 8 · 10 mm	2703 14 30006



DB 6



Wichtig: Immer mit Wasser kühlen, da ohne Kühlung die Lebensdauer auf 10 % der normalen Standzeit verringert wird! Empfohlene Drehzahl 1500/2000 U/Min. Nur drehend einsetzen!

Hinweis: Bei netzbetriebenen Geräten muss ein FI-/PRCD-Schutzschalter eingesetzt werden!

Important: Always cool with water because without cooling the tool life would be reduced to 10 % of the normal lifetime! Recommended drilling speed 1500/2000 rpm. Rotary use only!

Comment: For line-powered machines a FI-/PRCD-connector must be used!



Code	Inhalt Content		Artikel-Nr. Part-No.
ZH INOX	Zentrierhilfe, rostfrei 5 – 40 mm Centering guide, stainless 5 – 40 mm	1	2701 03 00001
ZH ABS	Zentrierhilfe ABS 4 – 13 mm Drill guide ABS 4 – 13 mm	1	2701 15 00022
ZH BIG	Zentrierhilfe BIG 8 – 83 mm Drill guide BIG 8 – 83 mm	1	2701 15 00033
ZH 413	Zentrierhilfe ABS 4 – 13 mm + Druckwasserbehälter Drill guide ABS 4 – 13 mm + compressed air water-supply bottle	1	2701 09 00002
ZH 883	Zentrierhilfe BIG 8 – 83 mm + Druckwasserbehälter Drill guide BIG 8 – 83 mm + compressed air water-supply bottle	1	2701 09 00003



ZH INOX



ZH ABS



ZH BIG



ZH 413



ZH 883

DIAMANT-Dosensenker PROFI, mit Turbo-Segmenten

DIAMOND Core drills PROFI, with Turbo-segments



Code 2720



Diamant-Dosensenker mit M16 Aufnahme für Beton, Kalksandstein und Mauerwerk. **Nur drehend einsetzbar!**

Diamond core drill with M16 thread for concrete, all types of limestone and masonry. **For rotary use only!**

Ø d mm	Segmente Segments	Segmenthöhe mm Segment height mm	Nutzlänge mm Working length mm		Artikel-Nr. Part-No.
68	3	8	60	1	2720 03 00068
82	4	8	60	1	2720 03 00082

Zubehör für DIAMANT-Dosensenker

Accessories for DIAMOND Core drills

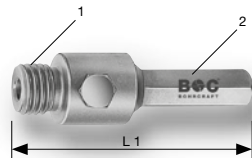

Code 2301 (6-kant / hex.)



Code 2301 (SDS-plus)

Aufnahmeschäfte ohne Zentrierbohrer
Arbors without pilot-drill

1	2	L1 mm		Artikel-Nr. Part-No.
M16	6-kant / hex. SW 12	100	1	2301 15 00001
M16	SDS-plus	100	1	2301 15 00002

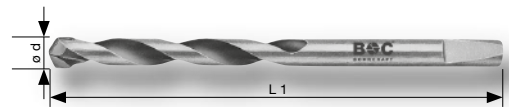

Code 2302

Zentrierbohrer HM / Pilot-drill TCT

Ø d mm	L1 mm		Artikel-Nr. Part-No.
8	120	1	2302 07 00800

Anwendungsübersicht für **DIAMANT**-Trennscheiben

Table of application for **DIAMOND** cutting discs

Werkstoff Material	Code 2730	Code 2735	Code 2740	Code 2745
Basalt / basalt	●●●	●	●	
Frischbeton / green concrete	●	●	●	
Altbeton / cured concrete	●●●	●●	●●	
Beton armiert / reinforced concrete	●●●	●	●	
Betondachpfannen frisch / roof tiles, green concrete	●●	●●	●●	
Betondachpfannen alt / roof tiles, cured concrete	●●●	●●	●●	
Dachpfannen Ton weich / clay-roof-tiles, soft	●●●	●●●	●●●	
Dachpfannen Ton hart / clay-roof-tiles, hard	●●●	●●	●●	
Estrich / screed	●	●	●	
feuerfeste Steine / refractory bricks	●●●	●	●	
Fliesen weich lasiert / glazed tiles soft				●●●
Fliesen weich nicht lasiert / tiles soft, not glazed				●●●
Fliesen hart / tiles hard				●●●
Gneis / gneiss	●●●	●	●	
Granit / granite	●●●	●	●	
Hohlblocksteine / hollow-block bricks	●	●●●	●●●	
Kacheln glasiert / stove tiles, glazed				●●●
Keramikfliesen / ceramic tiles				●●●
Klinker mittelhart / clinker brick, medium hardness	●●●	●●	●●	
Klinker hart / clinker brick, hard	●●●	●	●	
Leichtbeton / lightweight concrete	●	●●	●●	
Marmor / marble	●	●	●	●●
Mauerwerk / masonry	●	●●	●●	
Mörtelfugen / mortar joints	●	●●	●●	
Poroton / poroton	●	●●	●●	
Porphyr / porphyry	●●●	●	●	
Quarzit / quartzite	●●●			
Schamotte mittelhart / fireclay, medium hardness	●●●	●	●	
Schiefer natur / natural slate	●●●	●	●	
Tonziegel weich / clay bricks, soft	●	●●	●●	
Tonziegel hart gebrannt / clay bricks, hard burned	●●●	●●	●●	
Tonrohre / clay pipes	●●●	●●●	●●●	
Verbundsteinpflaster frisch / paving stone, green concrete	●	●	●	
Verbundsteinpflaster alt / paving stone, cured concrete	●●●	●	●	
Waschbeton / exposed aggregate concrete	●●●	●	●	
Ziegelstein / brick	●●●	●	●	

●●● empfohlen / recommended ●● geeignet / suitable ● bedingt geeignet / limited suitable

DIAMANT-Trennscheiben TURBO PROFI, mit Kühlöchern
DIAMOND Cutting discs TURBO PROFI, with cooling slots



Hochwertige Allround-Scheibe, lasergeschweißte Diamant-Segmente, mit Kühlöchern für langen Einsatz ohne Pausen.

Anwendung:

Stahlbeton, Granit, Naturstein, harte Materialien

Ø d1 mm	Ø d2 mm	Segmenthöhe mm Segment height mm		Artikel-Nr. Part-No.
115	22,23	10	1	2730 09 00115
125	22,23	10	1	2730 09 00125
150	22,23	10	1	2730 09 00150
230	22,23	10	1	2730 09 00230



High-performance allround blade, laser-welded diamond-segments, cooling slots for extended use without break.

Application:

For reinforced concrete, granite, natural stone and hard materials.

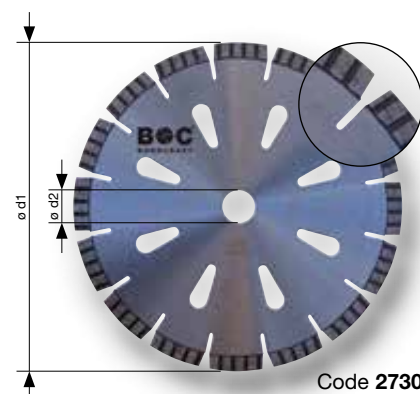

DIAMANT-Trennscheiben TURBO BASIC ☆☆☆
DIAMOND Cutting discs TURBO BASIC



Preiswerte Allround-Scheibe, gesintert, geschlossener Turbo-Schneidrand, präziser Schnitt.

Anwendung:

Beton, Stahlbeton, Dachziegel, Hohlblocksteine, Gehwegplatten, allgemeines Baustellenmaterial.

Ø d1 mm	Ø d2 mm	Segmenthöhe mm Segment height mm		Artikel-Nr. Part-No.
115	22,23	7	1	2735 09 00115
125	22,23	7	1	2735 09 00125
230	22,23	7	1	2735 09 00230



Low-cost allround blade, sintered, closed Turbo cutting edge, precise cut.

Application:

For concrete, reinforced concrete, roof tiles, hollow blocks, pavement stones, general building materials.

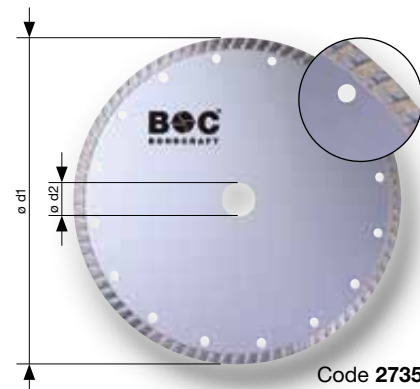

DIAMANTWERKZEUGE
DIAMOND-TOOLS

BASIC
DIAMANT

Preiswerte Allround-Scheibe, segmentiert, gesintert.

Anwendung:

Beton, Hohlblocksteine, Gehwegplatten, allgemeines Baustellenmaterial.

Low-cost allround blade, segmented, sintered.

Application:

For concrete, hollow blocks, pavement stones, general building materials.

Ø d1 mm	Ø d2 mm	Segmenthöhe mm Segment height mm		Artikel-Nr. Part-No.
115	22,23	7	1	2740 09 00115
125	22,23	7	1	2740 09 00125
230	22,23	7	1	2740 09 00230

DIAMANT 

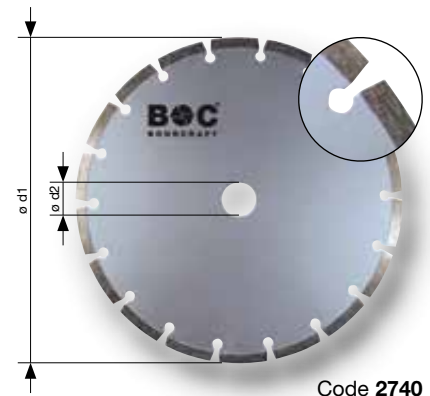

☆☆☆☆ DIAMANT-Trennscheiben PROFI CERAMIC
DIAMOND Cutting discs PROFI CERAMIC

PROFI
CERAMIC
DIAMANT

Extra dünne Trennscheibe (1,2 – 1,9 mm) für sehr feine Schnitte und saubere Schnittkanten.

Anwendung:

Fliesenpezialist! Für Feinsteinzeug, Natursteinplatten, Fliesen, Kacheln. **Bitte beachten: Nur gerade Schnitte, nicht schleifen; max. Materialstärke 10 mm!**

Extra-thin cutting blade (1,2 – 1,9 mm) for very fine cuts and clean cutting edges.

Application:

Specialist for tiles! For stoneware, natural stone slabs, tiles. **Please note: Only straight cuts, no re-grinding; max. thickness 10 mm.**

Ø d1 mm	Ø d2 mm	Schnittbreite mm Cutting width mm	Segmenthöhe mm Segment height mm		Artikel-Nr. Part-No.
115	22,23	1,2	7	1	2745 09 00115
125	22,23	1,2	7	1	2745 09 00125
230	22,23	1,9	7	1	2745 09 00230

DIAMANT 

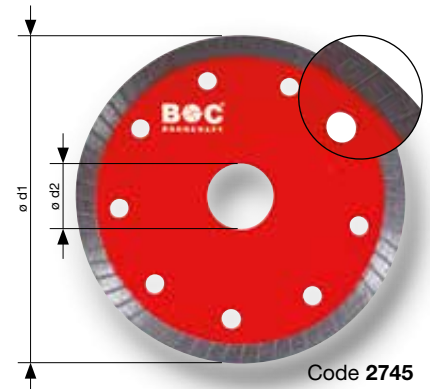

DIAMANTWERKZEUGE
DIAMOND-TOOLS



Zweireihige Diamant-Segmente.

Anwendung:

Zum Schleifen von Beton, Estrich und allgemeinem Baustellenmaterial.

Double row diamond segments.

Application:

For grinding concrete, floor pavement and general building materials.

Ø d1 mm	Ø d2 mm	Segmente Segments		Artikel-Nr. Part-No.
125	22,23	18	1	2750 09 00125

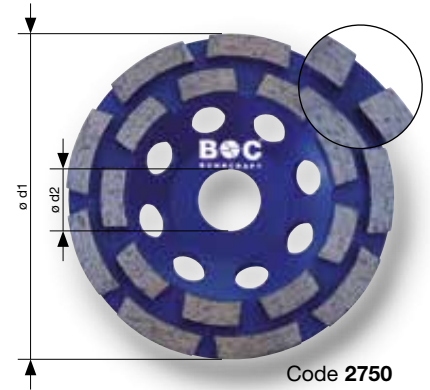



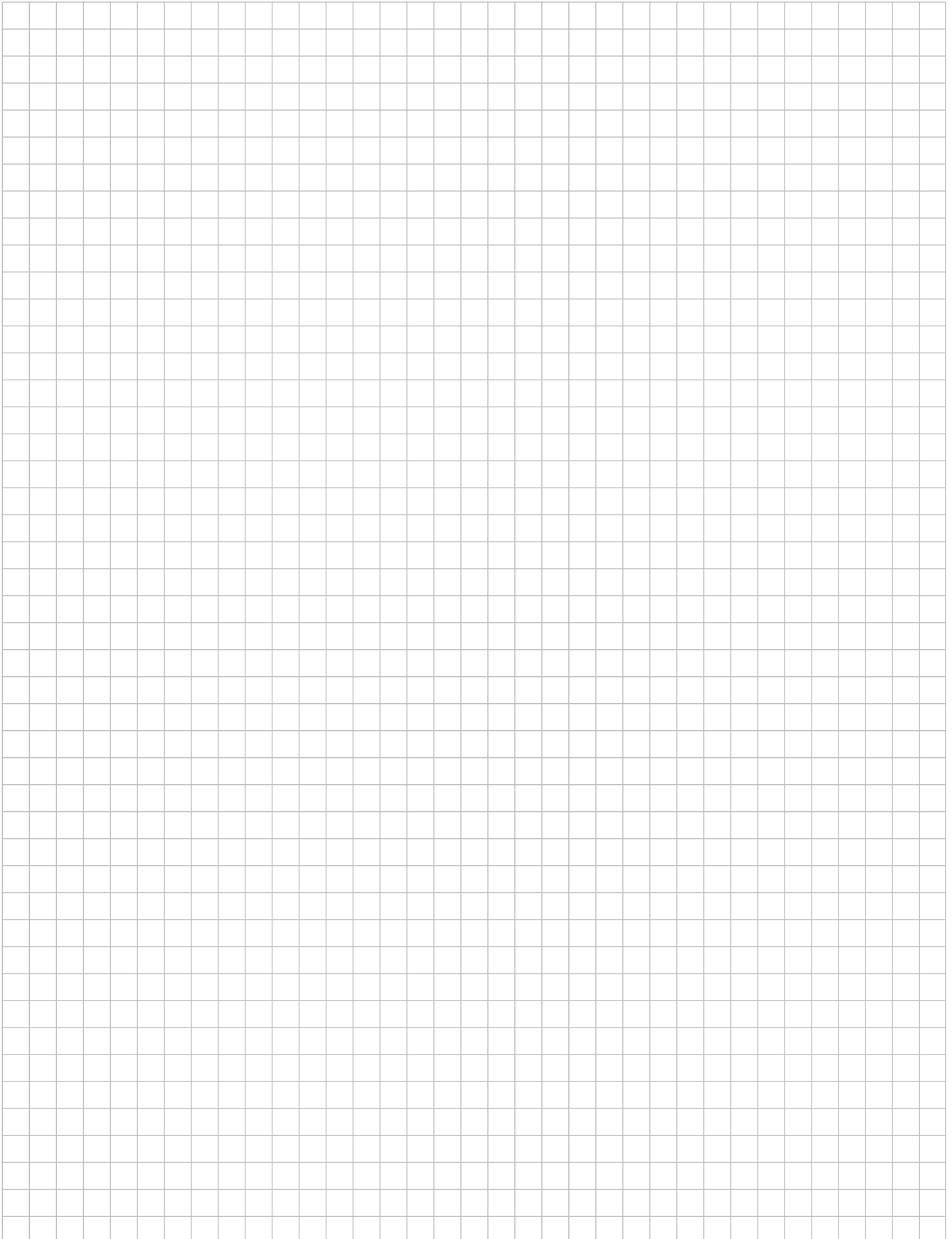























DIAMANTWERKZEUGE
DIAMOND-TOOLS





HOLZBOHRER
WOOD DRILL BITS



	Typ Type	Bezeichnung Description	Code	Seite Page
Spiralbohrer und Senker / Wood drill bits and countersinks				
		Holzspiralbohrer Brad point wood drill bits	3100	372
		Holzspiralbohrer, lange Ausführung Brad point wood drill bits, long version	3101	372
		INDUSTRIE HSS-G Premium Holzspiralbohrer Industrieausführung HSS-G premium wood drill bits industrial type	3110	373
		Aufstecksenker WS Shell drill countersinks	3450	374
		Senker (Krauskopf) DIN 6446 B Countersinks DIN 6446 B	3700	374
Forstnerbohrer + diverse / Forstner bits + miscellaneous bits				
		Forstnerbohrer Forstner bits	3250	375
		Kunstbohrer HM Cylinder boring bits, TCT	3261	376
		Scheibenschneider / Zapfenfräser DIN 7489 Tenon dowel / Plug cutters DIN 7489	3650	377
Schalungsbohrer + Flachfräsbohrer / Frame work drills + flat bits				
		Schalungsbohrer Rundschaft Frame work drills with cylindrical shank	3120	378
		SDS SDS-plus Schalungsbohrer Frame work drills with SDS-plus shank	3130	379
		Flachfräsbohrer Machine flat bits	3410 3411	383
Schlangenbohrer / Auger bits				
		LEWIS Schlangenbohrer mit 6-kant Schaft Auger bits with hexagon shank	3200	380 – 381
		LEWIS SDS SDS-plus Schlangenbohrer Auger bits with SDS-plus shank	3210	382



Code 3100



Code 3101



Basic Holzspiralbohrer mit Zentrierspitze, 2 Schulter-schneiden sowie doppelter Führungsfase. Für Bohrungen in Weichholz, Sperrholz und unbeschichteten Spanplatten. Code 3101 mit einer Führungsfase.

Basic brad point wood drill bit with center tip, 2 shouldered cutting edges and 2 guiding chamfers. For drilling in softwood, plywood and uncoated chipboard. Code 3101 with one guiding chamfer.

Ø d1 mm	L 1 mm	L 2 mm	Ø d2 mm		Artikel-Nr. Part-No.
3	61	33	3	1	3100 07 00300
4	75	43	4	1	3100 07 00400
5	86	52	5	1	3100 07 00500
6	93	57	6	1	3100 07 00600
7	109	69	7	1	3100 07 00700
8	117	75	8	1	3100 07 00800
9	120	81	9	1	3100 07 00900
10	133	87	10	1	3100 07 01000
11	142	89	10	1	3100 07 01100
12	151	96	10	1	3100 07 01200
13	151	96	10	1	3100 07 01300
14	151	96	10	1	3100 07 01400
15	160	100	10	1	3100 07 01500
16	160	100	10	1	3100 07 01600
18	180	120	10	1	3100 07 01800
20	200	130	10	1	3100 07 02000
6	250	155	6	1	3101 07 00600
8	250	155	8	1	3101 07 00800
10	250	155	10	1	3101 07 01000
12	250	155	10	1	3101 07 01200
14	250	155	10	1	3101 07 01400
16	250	155	10	1	3101 07 01600
18	250	155	10	1	3101 07 01800
20	250	155	10	1	3101 07 02000
8	400	340	8	1	3101 07 00840
10	400	340	10	1	3101 07 01040
12	400	340	10	1	3101 07 01240
14	400	340	10	1	3101 07 01440
16	400	340	10	1	3101 07 01640
20	400	340	10	1	3101 07 02040

Kunststoff-Kassetten / Plastic-Boxes

Bezeichnung Description	Teile Pieces	Inhalt Content	Display	Artikel-Nr. Part-No.
H 50	5	Ø 4 · 5 · 6 · 8 · 10 mm	18	3100 14 30005
H 80	8	Ø 3 · 4 · 5 · 6 · 7 · 8 · 9 · 10 mm	16	3100 14 30008



H 50



H 80



Display H 50

Holzspiralbohrer HSS-G geschliffen, Industrierausführung Brad point wood drill bits HSS-G fully ground, industrial-type

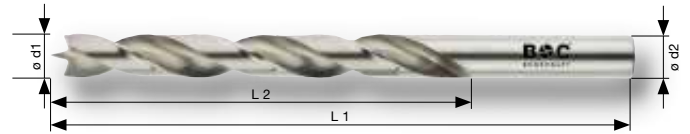

Code **3110**



Premium Holzspiralbohrer mit geschliffener Zentrierspitze und 2 Schulterseiden. Für präzise und maßhaltige Bohrungen in Weich- und Hartholz, Sperrholz sowie beschichteten Spanplatten.

First class brad point wood drill bit with grinded center tip and 2 shouldered cutting edges. For precise and accurate drilling in softwood and hardwood, plywood and coated chipboard.

Ø d1 mm	L 1 mm	L 2 mm	Ø d2 mm		Artikel-Nr. Part-No.
3	61	33	3	1	3110 07 00300
4	75	43	4	1	3110 07 00400
5	86	52	5	1	3110 07 00500
6	93	57	6	1	3110 07 00600
7	109	69	7	1	3110 07 00700
8	117	75	8	1	3110 07 00800
9	120	81	9	1	3110 07 00900
10	133	87	10	1	3110 07 01000
11	142	89	10	1	3110 07 01100
12	151	96	10	1	3110 07 01200
13	151	96	10	1	3110 07 01300
14	151	96	10	1	3110 07 01400
16	180	100	10	1	3110 07 01600

Kunststoff-Kassetten / Plastic-Boxes

Bezeichnung Description	Teile Pieces	Inhalt Content	Display	Artikel-Nr. Part-No.
HP 50	5	Ø 4 · 5 · 6 · 8 · 10 mm	18	3110 14 30005
HP 80	8	Ø 3 · 4 · 5 · 6 · 7 · 8 · 9 · 10 mm	16	3110 14 30008



- Präzisionsgeschliffene Zentrierspitze für saubere Bohrlöcher
- Sauberes Anbohren durch scharfe Zentrierspitze
- Precision grinded centering point for accurate holes
- Exact centering due to sharp centering tip



- Optimierte Spirale für schnelle Spanabfuhr
- Optimized flute geometry for quick chip removal



- Perfekt für kreisrunde, splinterfreie Bohrungen
- Perfect for clean and splinterfree holes



Aufstecksenker WS Shell drill countersinks

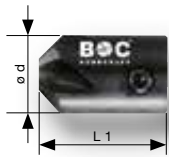

Code 3450



Hergestellt aus Werkzeugstahl, 5 Schneiden, Senkwinkel 90°. Zum Bohren und Ansenken in einem Arbeitsgang. Zum Aufstecken auf Holzspiralbohrer entsprechenden Durchmessers. Geeignet für Weichholz. Umgekehrt montiert auch als Bohrtiefenanschlag verwendbar.

Made of tool steel, 5 cutting edges, countersink angle 90°. For drilling and countersinking in soft wood in one single operation. Must be used in combination with a woodworking drill bit of corresponding diameter. Can be used as a drilling depth stop by turning the tool.

Ø d mm	für Bohrer Ø mm for drill Ø mm	L 1 mm		Artikel-Nr. Part-No.
12	3	25	1	3450 05 01203
12	4	25	1	3450 05 01204
12	5	25	1	3450 05 01205
12	6	25	1	3450 05 01206
16	8	25	1	3450 05 01608
16	10	25	1	3450 05 01610

Holz-kassette / Wooden-Box

Bezeichnung Description	Teile Pieces	Inhalt Content	Artikel-Nr. Part-No.
AHB 5	5	Ø 3 · 4 · 5 · 6 mm + Inbusschlüssel / L-key	3450 14 50005



Senker (Krauskopf) DIN 6446 B Countersinks DIN 6446 B

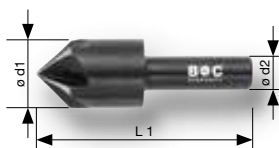

Code 3700



Hergestellt aus Werkzeugstahl, mit 5 Schneiden, Senkwinkel 90°. Zum Ansenken von Bohrungen in Holz, NE-Metallen und Kunststoffen für Linsen-kopf- und Senkschrauben.

Made of tool steel, with 5 cutting edges, countersink angle 90°. For countersinking drilling-holes in wood and other soft materials for different screw-heads.

Ø d1 mm	Ø d2 mm	L 1 mm		Artikel-Nr. Part-No.
10	6	50	1	3700 07 01000
13	8	50	1	3700 07 01300
16	8	50	1	3700 07 01600
20	8	50	1	3700 07 02000



Forstnerbohrer mit Zentrierspitze, 2 Hauptschneiden und einer geschlossenen Umfangsschneide, zylindrischer Schaft, rechtsschneidend, geschmiedete Ausführung. Zum punktgenauen und ausrissfreien Bohren von Weichhölzern, etc. Ideal geeignet für die Verwendung mit Akkuschauber/Handbohrmaschine.

Forstner bit with centre-point, 2 cutting edges and one circumferential cutting blade, right hand cutting, forged version. For exact and splinterfree holes in wood, etc. Perfect for use with cordless/corded machines.

Ø d1 mm	Ø d2 mm	L 1 mm		Artikel-Nr. Part-No.
8	8	90	1	3250 05 00800
10	8	90	1	3250 05 01000
12	8	90	1	3250 05 01200
14	8	90	1	3250 05 01400
15	8	90	1	3250 05 01500
16	8	90	1	3250 05 01600
18	8	90	1	3250 05 01800
20	8	90	1	3250 05 02000
22	8	90	1	3250 05 02200
24	8	90	1	3250 05 02400
25	8	90	1	3250 05 02500
26	8	90	1	3250 05 02600
28	8	90	1	3250 05 02800
30	8	90	1	3250 05 03000
32	10	90	1	3250 05 03200
35	10	90	1	3250 05 03500
38	10	90	1	3250 05 03800
40	10	90	1	3250 05 04000
45	10	90	1	3250 05 04500
50	10	90	1	3250 05 05000

Holz-kassette / Wooden-Box

Bezeichnung Description	Teile Pieces	Inhalt Content	Artikel-Nr. Part-No.
FB 5	5	Ø 15 · 20 · 25 · 30 · 35 mm	3250 14 50005



FB 5

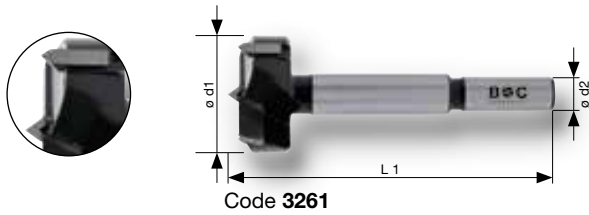

Code 3261



Geschmiedeter Spezialstahl mit Zentrierspitze, 2 Hauptschneiden und 2 Vorschneidern aus Hartmetall, zylindrischer Schaft, rechtsschneidend, Gesamtlänge 90 mm. Für saubere und maßhaltige Bohrungen in Hartholz, verleimten und kunststoffbeschichteten Holzplatten, etc. Aufgrund der HM-Bestückung hohe Standzeit.

Forged special-steel, centre-point, 2 main-cutters and 2 cutting-lips made of carbide, cylindrical shank, right hand cutting, total length 90 mm. For exact, splinterfree drilling in hardwood, veneered wood sheet, chipboard, etc. Long tool life due to the carbide tips.

Ø d1 mm	Ø d2 mm	L 1 mm		Artikel-Nr. Part-No.
10	8	90	1	3261 05 01000
15	8	90	1	3261 05 01500
18	8	90	1	3261 05 01800
20	8	90	1	3261 05 02000
24	8	90	1	3261 05 02400
25	8	90	1	3261 05 02500
30	10	90	1	3261 05 03000
35	10	90	1	3261 05 03500
40	10	90	1	3261 05 04000

Holz-kassette / Wooden-Box

Bezeichnung Description	Teile Pieces	Inhalt Content	Artikel-Nr. Part-No.
KBH 5	5	Ø 15 · 20 · 25 · 30 · 35 mm	3261 14 50005



KBH 5

Scheibenschneider / Zapfenfräser DIN 7489
Tenon dowel / plug cutters DIN 7489



Präzise hinterschliffene Innen- und Außenschneiden, hergestellt aus legiertem Werkzeugstahl, brüniert und teilweise poliert. Geeignet zum Ausbessern von ausgebrochenen Ästen und zum Ausfüllen von schlechten Holzteilen in Verbindung mit BC-Forstnerbohrern.

Precision ground outer and inner cutting edge, made of alloyed tool steel, black finish and partly polished. Designed to repair knot-holes in connection with BC-Forstner-Bits.

Ø d1 mm	Ø d2 mm	L 1 mm		Artikel-Nr. Part-No.
8	11	140	1	3650 05 00800
10	11	140	1	3650 05 01000
12	13	140	1	3650 05 01200
15	13	140	1	3650 05 01500
16	13	140	1	3650 05 01600
20	13	140	1	3650 05 02000
22	13	140	1	3650 05 02200
25	13	140	1	3650 05 02500
26	13	140	1	3650 05 02600
30	13	140	1	3650 05 03000
35	16	160	1	3650 05 03500
40	16	160	1	3650 05 04000



SCHEIBENSCHNEIDER
PLUG CUTTERS

Schalungsbohrer, Rundschaft

Frame work drills, cylindrical shank

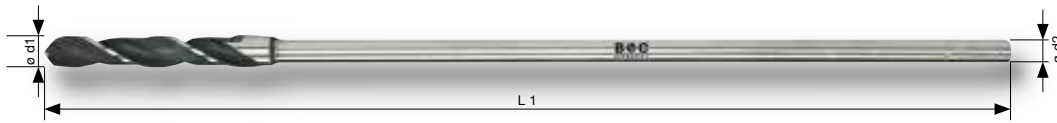

Code **3120**



Robuster Spiralbohrer mit langem Schaft und Dachspitze mit Sonderanschliff. Ab 12 mm Ø mit offenem Spanauslauf. Zum Bohren von Schalungen, Balken, Dielen, Gips- und Leichtbauplatten. Unfallgefahr bei freilaufendem Bohrer. Vor dem Einschalten der Maschine den Bohrer am Bohrobjekt ansetzen.

Solid Twist drill with extended shank and special tip. 12 mm drills and bigger dimensions with open flute for better chip removal. Designed for drilling inner and outer covering boards in one operation; also for beams, hardboard etc. Accident-danger at freerunning drills. Place drill to the work-piece before switching on the machine.

Ø d1 mm	L 1 mm	Ø d2 mm		Artikel-Nr. Part-No.
6	400	6,0	1	3120 07 00640
6	600	6,0	1	3120 07 00660
8	400	6,0	1	3120 07 00840
8	600	6,0	1	3120 07 00860
10	400	8,0	1	3120 07 01040
10	600	8,0	1	3120 07 01060
12	400	8,0	1	3120 07 01240
12	600	8,0	1	3120 07 01260
13*	400	8,0	1	3120 07 01340
14	400	8,0	1	3120 07 01440
14	600	8,0	1	3120 07 01460
16	400	10,0	1	3120 07 01640
16	600	10,0	1	3120 07 01660
17*	400	10,0	1	3120 07 01740
18	400	10,0	1	3120 07 01840
18	600	10,0	1	3120 07 01860
20	400	10,0	1	3120 07 02040
20	600	10,0	1	3120 07 02060
21*	400	12,0	1	3120 07 02140
22	400	12,0	1	3120 07 02240
22	600	12,0	1	3120 07 02260
24	400	12,0	1	3120 07 02440
24	600	12,0	1	3120 07 02460
26	400	12,0	1	3120 07 02640
26	600	12,0	1	3120 07 02660
28	400	12,0	1	3120 07 02840
28	600	12,0	1	3120 07 02860
30	400	12,0	1	3120 07 03040
30	600	12,0	1	3120 07 03060

* Nur solange Vorrat reicht / * Only as long as stock lasts

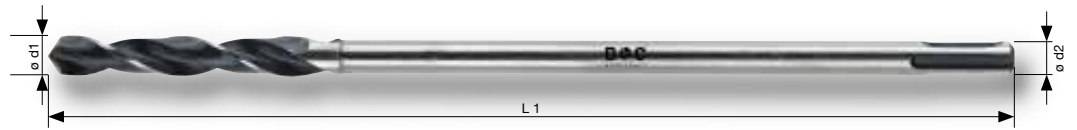

Code 3130



Robuster Spiralbohrer mit langem Schaft und Dachspitze mit Sonderanschliff. Ab 12 mm Ø mit offenem Spanauslauf. Zum Bohren von Schalungen, Balken, Dielen, Gips- und Leichtbauplatten. Unfallgefahr bei freilaufendem Bohrer. Vor dem Einschalten der Maschine den Bohrer am Bohrobject ansetzen.

Solid twist drill with extended shank and special tip. 12 mm drills and bigger dimensions with open flute for better chip removal. Designed for drilling inner and outer covering boards in one operation; also for beams, hardboard etc. Accident-danger at freerunning drills. Place drill to the work-piece before switching on the machine.

Ø d1 mm	L 1 mm	Ø d2		Artikel-Nr. Part-No.
10	600	SDS-plus	1	3130 07 01060
12	600	SDS-plus	1	3130 07 01260
14	600	SDS-plus	1	3130 07 01460
16	600	SDS-plus	1	3130 07 01660
18	600	SDS-plus	1	3130 07 01860
20	600	SDS-plus	1	3130 07 02060

Schlangenbohrer Form LEWIS

Auger bits LEWIS-pattern

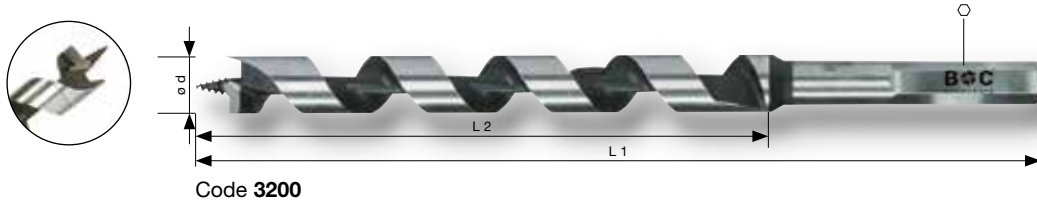

Z1

Gefräste und überschlifene Spirale, selbsteinziehende Gewindespitze, 1 Vorschneider, spezieller Freischliff hinter dem Schneidkopf. Punkt-genaues Bohren mit sehr guter Spanabfuhr. Durch den speziellen Freischliff auch zum Bohren in feuchtem Holz geeignet.

Milled version with self-threating tip, 1 cutting lip, special step-tip. Exact drilling with excellent chip removal. Due to special "step-tip" also for drilling in wet wood.

Ø d mm	L 1 mm	L 2 mm	mm		Artikel-Nr. Part-No.
6	235	160	5,6	1	3200 07 00623
6	320	255	5,6	1	3200 07 00632
6	460	360	5,6	1	3200 07 00646
6	600	520	5,6	1	3200 07 00660
8	235	160	7,2	1	3200 07 00823
8	320	255	7,2	1	3200 07 00832
8	460	360	7,2	1	3200 07 00846
8	600	520	7,2	1	3200 07 00860
10*	95	60	9,0	1	3200 07 01095
10	235	160	9,0	1	3200 07 01023
10	320	255	9,0	1	3200 07 01032
10	460	360	9,0	1	3200 07 01046
10	600	520	9,0	1	3200 07 01060
12	235	160	10,9	1	3200 07 01223
12	320	255	10,9	1	3200 07 01232
12	460	360	10,9	1	3200 07 01246
12	600	520	10,9	1	3200 07 01260
14	235	160	11,2	1	3200 07 01423
14	320	255	11,2	1	3200 07 01432
14	460	360	11,2	1	3200 07 01446
14	600	520	11,2	1	3200 07 01460
16	235	160	11,2	1	3200 07 01623
16	320	255	11,2	1	3200 07 01632
16	460	360	11,2	1	3200 07 01646
16	600	520	11,2	1	3200 07 01660
18	235	160	11,2	1	3200 07 01823
18	320	255	11,2	1	3200 07 01832
18	460	360	11,2	1	3200 07 01846
18	600	520	11,2	1	3200 07 01860
20*	95	60	11,2	1	3200 07 02095
20*	155	90	11,2	1	3200 07 02015
20	235	160	11,2	1	3200 07 02023
20	320	255	11,2	1	3200 07 02032
20	460	360	11,2	1	3200 07 02046
20	600	520	11,2	1	3200 07 02060
22*	155	90	11,2	1	3200 07 02215
22	235	160	11,2	1	3200 07 02223
22	460	360	11,2	1	3200 07 02246
22	600	520	11,2	1	3200 07 02260
24*	155	90	11,2	1	3200 07 02415
24	235	160	11,2	1	3200 07 02423
24	460	360	11,2	1	3200 07 02446
24	600	520	11,2	1	3200 07 02460
25	235	160	11,2	1	3200 07 02523
25	460	360	11,2	1	3200 07 02546

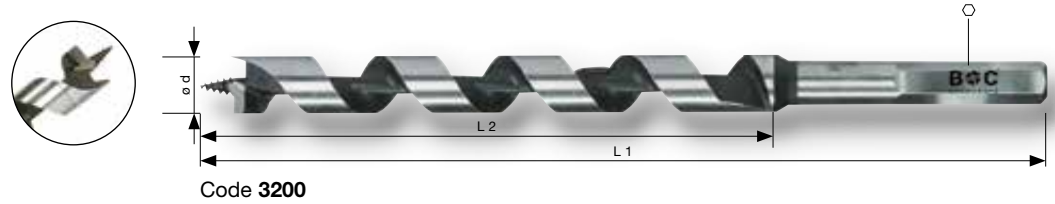

Ø d mm	L 1 mm	L 2 mm	⬡ mm		Artikel-Nr. Part-No.
25	600	520	11,2	1	3200 07 02560
26*	155	90	11,2	1	3200 07 02615
26	235	160	11,2	1	3200 07 02623
26	460	360	11,2	1	3200 07 02646
26	600	520	11,2	1	3200 07 02660
28	235	160	11,2	1	3200 07 02823
28	460	360	11,2	1	3200 07 02846
28	600	520	11,2	1	3200 07 02860
30*	155	90	11,2	1	3200 07 03015
30	235	160	11,2	1	3200 07 03023
30	460	360	11,2	1	3200 07 03046
30	600	520	11,2	1	3200 07 03060
32	235	160	11,2	1	3200 07 03223
32	460	360	11,2	1	3200 07 03246
32	600	520	11,2	1	3200 07 03260

* Nur solange Vorrat reicht / * Only as long as stock lasts

Holzkassetten / Wooden-Boxes

Bezeichnung Description	Teile Pieces	Inhalt Content	Artikel-Nr. Part-No.
SB 235	8	Ø 6 · 8 · 10 · 12 · 14 · 16 · 18 · 20 x 235 mm	3200 14 50623
SB 320	6	Ø 10 · 12 · 14 · 16 · 18 · 20 x 320 mm	3200 14 50632
SB 460	6	Ø 10 · 12 · 14 · 16 · 18 · 20 x 460 mm	3200 14 50646



SB 320

Schlangenbohrer Form LEWIS, SDS-plus Schaft

Auger bits LEWIS-pattern, SDS-plus shank

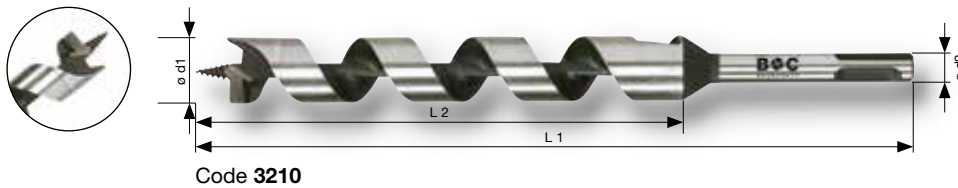

Code 3210



Gefräste und überschlifene Spirale, selbsteinziehende Gewindespitze, 1 Vorschneider, spezieller Freischliff hinter dem Schneidkopf. Punktgenaues Bohren mit sehr guter Spanabfuhr, für Weich- und die meisten Harthölzer geeignet. Durch den speziellen Freischliff auch zum Bohren in feuchtem Holz geeignet.

Milled version with self-threating tip, 1 cutting lip, special step-tip. Exact drilling with excellent chip removal in soft- and most hard-woods. Due to special "step-tip" also suitable for drilling in wet wood.

Ø d1 mm	L 1 mm	L 2 mm	Ø d2		Artikel-Nr. Part-No.
8	235	160	SDS-plus	1	3210 07 00823
10	235	160	SDS-plus	1	3210 07 01023
10	460	360	SDS-plus	1	3210 07 01046
12	235	160	SDS-plus	1	3210 07 01223
12	460	360	SDS-plus	1	3210 07 01246
14	235	160	SDS-plus	1	3210 07 01423
14	460	360	SDS-plus	1	3210 07 01446
16	235	160	SDS-plus	1	3210 07 01623
16	460	360	SDS-plus	1	3210 07 01646
18	235	160	SDS-plus	1	3210 07 01823
18	460	360	SDS-plus	1	3210 07 01846
20	235	160	SDS-plus	1	3210 07 02023
20	460	360	SDS-plus	1	3210 07 02046
22	235	160	SDS-plus	1	3210 07 02223
22	460	360	SDS-plus	1	3210 07 02246
24*	460	360	SDS-plus	1	3210 07 02446
25	235	160	SDS-plus	1	3210 07 02523
25	460	360	SDS-plus	1	3210 07 02546

* Nur solange Vorrat reicht / * Only as long as stock lasts

SCHLANGENBOHRER
AUGER BITS



Code 3411 (400 mm)

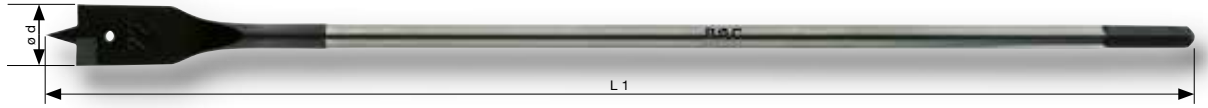

Geschliffene Ausführung mit Zentrierspitze und 2 Schneiden auf jeder Seite, Sechskant-Schaft, aus gehärtetem Werkzeugstahl. Für Bohrungen in Weichholz, Balken und Spanplatten.

Ground version with centre tip and 2 cutting-edges on both sides, hexagon-shank, made of heat-tempered tool steel. For drilling in soft-wood, beams and chipboards.

Ø d mm	L 1 mm	Hexagon	Shank	Artikel-Nr. Part-No.
6	150	1/4" / 6,35 mm	1	3410 07 00600
8	150	1/4" / 6,35 mm	1	3410 07 00800
10	150	1/4" / 6,35 mm	1	3410 07 01000
12	150	1/4" / 6,35 mm	1	3410 07 01200
13	150	1/4" / 6,35 mm	1	3410 07 01300
14	150	1/4" / 6,35 mm	1	3410 07 01400
16	150	1/4" / 6,35 mm	1	3410 07 01600
17	150	1/4" / 6,35 mm	1	3410 07 01700
18	150	1/4" / 6,35 mm	1	3410 07 01800
19	150	1/4" / 6,35 mm	1	3410 07 01900
20	150	1/4" / 6,35 mm	1	3410 07 02000
22	160	1/4" / 6,35 mm	1	3410 07 02200
24	160	1/4" / 6,35 mm	1	3410 07 02400
25	160	1/4" / 6,35 mm	1	3410 07 02500
26	160	1/4" / 6,35 mm	1	3410 07 02600
28	160	1/4" / 6,35 mm	1	3410 07 02800
30	160	1/4" / 6,35 mm	1	3410 07 03000
32	160	1/4" / 6,35 mm	1	3410 07 03200
34	160	1/4" / 6,35 mm	1	3410 07 03400
35	160	1/4" / 6,35 mm	1	3410 07 03500
36	160	1/4" / 6,35 mm	1	3410 07 03600
38	160	1/4" / 6,35 mm	1	3410 07 03800
40	160	1/4" / 6,35 mm	1	3410 07 04000
8*	400	-	1	3411 07 00800
10*	400	-	1	3411 07 01000
12*	400	-	1	3411 07 01200
14*	400	-	1	3411 07 01400
16*	400	-	1	3411 07 01600
18*	400	-	1	3411 07 01800
19*	400	-	1	3411 07 01900
20*	400	-	1	3411 07 02000
28*	400	-	1	3411 07 02800
30*	400	-	1	3411 07 03000
32*	400	-	1	3411 07 03200
35*	400	-	1	3411 07 03500
38*	400	-	1	3411 07 03800

* Nur solange Vorrat reicht / * Only as long as stock lasts

BC Multi-Pack / BC Multi-Pack

Bezeichnung Description	Teile Pieces	Inhalt Content	Artikel-Nr. Part-No.
FL 5	5	Ø 16 · 18 · 20 · 22 · 24 x 150 mm	3410 13 30005





















FLACHFRÄSBOHRER
MACHINE FLAT BITS





LOCHSÄGEN
HOLE SAWS



	Typ Type	Bezeichnung Description	Code	Seite Page
Lochsägen / Hole saws				
		Bi-Metall Lochsägen HSS Bi-Metal hole saws HSS	1900	388 – 389
		VA-CUT8 Premium Bi-Metall Lochsägen HSS-E (Co8) kobaltlegiert Premium Bi-Metal hole saws HSS-E (Co8) cobalt alloyed	1901	390 – 391
		Zubehör für Lochsägen Accessories for hole saws	1910 1911	387
		MULTI-CUT Mehrzweck-Lochsägen HM Multi-Purpose hole saws TCT	1930	392
		Zubehör für Mehrzweck-Lochsägen HM Accessories for Multi-Purpose hole saws TCT	1935 1936	393
DIAMANT Lochsägen / DIAMOND hole saws				
		DIAMANT M14 Diamant-Fliesenbohrer M14 für Winkelschleifer Diamond tile drill bits M14 for angle grinders	2702	360
		DIAMANT Diamant-Fliesenbohrer mit 6-kant Schaft Diamond tile drill bits with hex-shank	2701	361
		BASIC Diamant-Fliesenbohrer mit 3-Flächenschaft Diamond tile drill bits with triangle-shank	2703	362
HM-Lochsägen / TCT-hole saws				
		HM TCT Mehrbereichs-Lochsägen HM + Zubehör Multigrade hole saws TCT + accessories	1920 1925	157

	Bi-Metall Lochsagen Bi-Metal hole saws		HM Lochsagen TCT hole saws	Diamant-Lochsagen Diamond hole saws
	Code 1900 HSS 	Code 1901 HSS-E VA-CUT® 	Code 1930 MULTI-CUT 	Code 2701 – 2703 DIAMANT  
Metall Metal		 		
Aluminium Aluminium	 	 		
Edelstahl Stainless steel				
NE-Metalle Non ferrous metal	 	 		
Holz Wood			 	
Laminat Laminate			 	
Kunststoffe Plastics			 	
Acrylglas Acrylic glass			 	 
Keramik · Fliesen Ceramics · Tiles				 
Glas Glass				 
Glasfaser Glass-fibre			 	 
Arbeitsplatten Worktops			 	
Gipskartonplatten Gypsum board	 	 	 	
MDF MDF			 	
Mauerwerk Masonry				

  empfohlen / recommended  geeignet / suitable

Aufnahmeschäfte mit Zentrierbohrer Arbors with pilot-drill



Code 1910 • 1913

Typ Type	Schaft Shank	Zentrierbohrer Pilot-drill	Ø mm Lochsägen Ø mm Hole saws	Gewinde Thread	Bild Figure		Artikel-Nr. Part-No.
AS 1	SW 11	HSS	14 – 30	1/2" x 20	1	1	1910 09 00001
AS 11	SW 8,5	HSS	14 – 30	1/2" x 20	1	1	1910 09 00011
AS 4	SDS-plus	HSS	14 – 30	1/2" x 20	3	1	1910 09 00004
AS 3	SW 11	HSS	32 – 210	5/8" x 18	2	1	1910 09 00003
AS 33	SW 8,5	HSS	32 – 210	5/8" x 18	2	1	1910 09 00033
AS 6	SDS-plus	HSS	32 – 210	5/8" x 18	4	1	1910 09 00006
AS-E11	SW 8,5	HSS-E (Co5)	14 – 30	1/2" x 20	1	1	1913 09 00011
AS-E33	SW 8,5	HSS-E (Co5)	32 – 210	5/8" x 18	2	1	1913 09 00033

Zentrierbohrer für Aufnahmeschäfte Pilot-drills for arbors



Code 1911 HSS



Code 1911 HSS-E (Co5)

Typ Type	Ausführung Version	Ø x L mm	Passend in Fitting in		Artikel-Nr. Part-No.
ZB 1	HSS	6,35 x 104	AS 1 + AS 11	10	1911 03 00001
ZB 2	HSS	6,35 x 83	AS 3 - AS 6	10	1911 03 00002
ZB 3	HSS-E (Co5)	6,35 x 104	AS 1 + AS 11	1	1911 07 00003
ZB 4	HSS-E (Co5)	6,35 x 83	AS 3 - AS 6	1	1911 07 00004

Bi-Metall Lochsägen HSS

Bi-Metal hole saws HSS

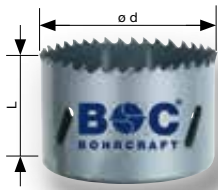

Code 1900

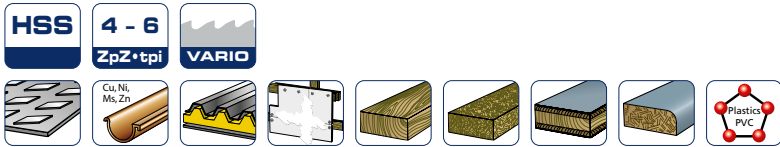

HSS Bi-Metall Lochsäge mit variabler Zahnteilung (4/6 Zähne pro Zoll). Hohe Laufruhe und geringe Wärmeentwicklung sorgen für einen gleichmäßigen Schnitt und eine lange Lebensdauer.

HSS bi-metal hole saw with variable tooth pitch (4/6 teeth per inch). Smooth running and low heat generation ensure an even cut and a long tool life.

Ø d mm	Ø d Zoll / Inch	L mm	Aufnahmen Arbors		Artikel-Nr. Part-No.
14	9/16"	38	AS1 · AS11 · AS4	1	1900 09 00014
16	5/8"	38	AS1 · AS11 · AS4	1	1900 09 00016
17	11/16"	38	AS1 · AS11 · AS4	1	1900 09 00017
19	3/4"	38	AS1 · AS11 · AS4	1	1900 09 00019
20	-	38	AS1 · AS11 · AS4	1	1900 09 00020
21	13/16"	38	AS1 · AS11 · AS4	1	1900 09 00021
22	7/8"	38	AS1 · AS11 · AS4	1	1900 09 00022
24	15/16"	38	AS1 · AS11 · AS4	1	1900 09 00024
25	1"	38	AS1 · AS11 · AS4	1	1900 09 00025
27	11/16"	38	AS1 · AS11 · AS4	1	1900 09 00027
29	11/8"	38	AS1 · AS11 · AS4	1	1900 09 00029
30	1.3/16"	38	AS1 · AS11 · AS4	1	1900 09 00030
32	1.1/4"	38	AS3 · AS33 · AS6	1	1900 09 00032
33	1.5/16"	38	AS3 · AS33 · AS6	1	1900 09 00033
35	1.3/8"	38	AS3 · AS33 · AS6	1	1900 09 00035
37	1.7/16"	38	AS3 · AS33 · AS6	1	1900 09 00037
38	1.1/2"	38	AS3 · AS33 · AS6	1	1900 09 00038
40	1.9/16"	38	AS3 · AS33 · AS6	1	1900 09 00040
41	1.5/8"	38	AS3 · AS33 · AS6	1	1900 09 00041
43	1.11/16"	38	AS3 · AS33 · AS6	1	1900 09 00043
44	1.3/4"	38	AS3 · AS33 · AS6	1	1900 09 00044
45	-	38	AS3 · AS33 · AS6	1	1900 09 00045
46	1.13/16"	38	AS3 · AS33 · AS6	1	1900 09 00046
48	1.7/8"	38	AS3 · AS33 · AS6	1	1900 09 00048
50	-	38	AS3 · AS33 · AS6	1	1900 09 00050
51	2"	38	AS3 · AS33 · AS6	1	1900 09 00051
52	2.1/16"	38	AS3 · AS33 · AS6	1	1900 09 00052
54	2.1/8"	38	AS3 · AS33 · AS6	1	1900 09 00054
55	-	38	AS3 · AS33 · AS6	1	1900 09 00055
56	-	38	AS3 · AS33 · AS6	1	1900 09 00056
57	2.1/4"	38	AS3 · AS33 · AS6	1	1900 09 00057
59	2.5/16"	38	AS3 · AS33 · AS6	1	1900 09 00059
60	2.3/8"	38	AS3 · AS33 · AS6	1	1900 09 00060
64	2.1/2"	38	AS3 · AS33 · AS6	1	1900 09 00064
65	2.9/16"	38	AS3 · AS33 · AS6	1	1900 09 00065
67	2.5/8"	38	AS3 · AS33 · AS6	1	1900 09 00067
68	2.11/16"	38	AS3 · AS33 · AS6	1	1900 09 00068
70	2.3/4"	38	AS3 · AS33 · AS6	1	1900 09 00070
73	2.7/8"	38	AS3 · AS33 · AS6	1	1900 09 00073
75	-	38	AS3 · AS33 · AS6	1	1900 09 00075
76	3"	38	AS3 · AS33 · AS6	1	1900 09 00076
79	3.1/8"	38	AS3 · AS33 · AS6	1	1900 09 00079
83	3.1/4"	38	AS3 · AS33 · AS6	1	1900 09 00083
86	3.3/8"	38	AS3 · AS33 · AS6	1	1900 09 00086
89	3.1/2"	38	AS3 · AS33 · AS6	1	1900 09 00089
92	3.5/8"	38	AS3 · AS33 · AS6	1	1900 09 00092
95	3.3/4"	38	AS3 · AS33 · AS6	1	1900 09 00095
98	3.7/8"	38	AS3 · AS33 · AS6	1	1900 09 00098
102	4"	38	AS3 · AS33 · AS6	1	1900 09 00102
105	4.1/8"	38	AS3 · AS33 · AS6	1	1900 09 00105
108	4.1/4"	38	AS3 · AS33 · AS6	1	1900 09 00108
111	4.3/8"	38	AS3 · AS33 · AS6	1	1900 09 00111

LOCHSÄGEN
HOLE SAWS

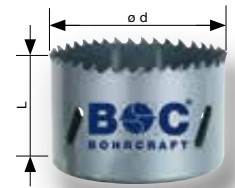

Code 1900

Ø d mm	Ø d Zoll / Inch	L mm	Aufnahmen Arbors		Artikel-Nr. Part-No.
114	4.1/2"	38	AS3 · AS33 · AS6	1	1900 09 00114
121	4.3/4"	38	AS3 · AS33 · AS6	1	1900 09 00121
127	5"	38	AS3 · AS33 · AS6	1	1900 09 00127
133	5.1/4"	38	AS3 · AS33 · AS6	1	1900 09 00133
140	5.1/2"	38	AS3 · AS33 · AS6	1	1900 09 00140
152	6"	38	AS3 · AS33 · AS6	1	1900 09 00152
168	6.5/8"	38	AS3 · AS33 · AS6	1	1900 09 00168
210	8.9/32"	38	AS3 · AS33 · AS6	1	1900 09 00210

Kunststoff-Koffer / Plastic-Boxes

Bezeichnung Description	Teile Pieces	Inhalt Content	Artikel-Nr. Part-No.
LS 6 ELEKTRO	8	Ø 22 · 29 · 35 · 44 · 51 · 68 mm AS 11 (14-30 mm 6-kant / hex-shank) AS 33 (32-210 mm 6-kant / hex-shank)	1900 14 30006
RLS 9 SANITÄR	11	Ø 19 · 22 · 29 · 35 · 38 · 44 · 51 · 57 · 64 mm AS 11 (14-30 mm 6-kant / hex-shank) AS 33 (32-210 mm 6-kant / hex-shank)	1900 13 30009
RLS 12 ELEKTRO 2	14	Ø 16 · 19 · 22 · 25 · 29 · 32 · 35 · 38 · 45 · 51 · 64 · 76 mm AS 11 (14-30 mm 6-kant / hex-shank) AS 33 (32-210 mm 6-kant / hex-shank)	1900 13 30012
RLS 14 ALLROUND	14	Ø 19 · 22 · 25 · 29 · 32 · 35 · 44 · 51 · 57 · 64 · 68 · 76 mm AS 11 (14-30 mm 6-kant / hex-shank) AS 33 (32-210 mm 6-kant / hex-shank)	1900 13 30014
RLS 15 UNIVERSAL	17	Ø 19 · 22 · 29 · 35 · 38 · 44 · 51 · 57 · 64 · 76 · 83 · 92 · 95 · 105 · 127 mm AS 11 (14-30 mm 6-kant / hex-shank) AS 33 (32-210 mm 6-kant / hex-shank)	1900 13 30015



LS 6 ELEKTRO



RLS 14 ALLROUND



LOCHSÄGEN
HOLE SAWS

Bi-Metall Lochsägen HSS-E (Co8) kobaltlegiert

Bi-Metal hole saws HSS-E M42 (Co8) cobalt alloyed

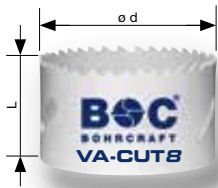

Code 1901

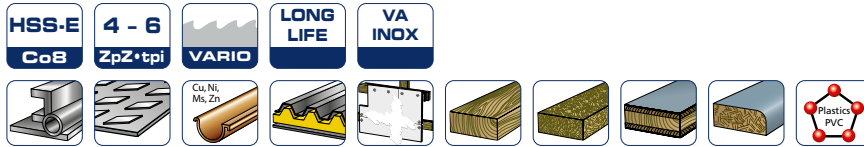

HSS-E Bi-Metall Lochsäge mit 8% Kobaltlegierung und variabler Zahnteilung mit 4/6 Zähnen pro Zoll. Hohe Laufruhe und geringe Wärmeentwicklung sorgen für einen gleichmäßigen Schnitt und eine längere Lebensdauer. Besonders geeignet für die Bearbeitung Stahl und rostfreiem Stahl (V2A / V4A).

HSS-E bi-metal hole saw alloyed with 8% cobalt and variable tooth pitch with 4/6 teeth per inch. Smooth running and low heat generation ensure an even cut and a long tool lifetime. Suitable for machining steel and stainless steel (AISI 304 / AISI 316).

Ø d mm	Ø d Zoll / Inch	L mm	Aufnahmen Arbors		Artikel-Nr. Part-No.
14	9/16"	38	AS1 · AS11 · AS4	1	1901 09 00014
16	5/8"	38	AS1 · AS11 · AS4	1	1901 09 00016
17	11/16"	38	AS1 · AS11 · AS4	1	1901 09 00017
19	3/4"	38	AS1 · AS11 · AS4	1	1901 09 00019
20	-	38	AS1 · AS11 · AS4	1	1901 09 00020
21	13/16"	38	AS1 · AS11 · AS4	1	1901 09 00021
22	7/8"	38	AS1 · AS11 · AS4	1	1901 09 00022
24	15/16"	38	AS1 · AS11 · AS4	1	1901 09 00024
25	1"	38	AS1 · AS11 · AS4	1	1901 09 00025
27	11/16"	38	AS1 · AS11 · AS4	1	1901 09 00027
29	11/8"	38	AS1 · AS11 · AS4	1	1901 09 00029
30	1.3/16"	38	AS1 · AS11 · AS4	1	1901 09 00030
32	1.1/4"	38	AS3 · AS33 · AS6	1	1901 09 00032
33	1.5/16"	38	AS3 · AS33 · AS6	1	1901 09 00033
35	1.3/8"	38	AS3 · AS33 · AS6	1	1901 09 00035
37	1.7/16"	38	AS3 · AS33 · AS6	1	1901 09 00037
38	1.1/2"	38	AS3 · AS33 · AS6	1	1901 09 00038
40	1.9/16"	38	AS3 · AS33 · AS6	1	1901 09 00040
41	1.5/8"	38	AS3 · AS33 · AS6	1	1901 09 00041
43	1.11/16"	38	AS3 · AS33 · AS6	1	1901 09 00043
44	1.3/4"	38	AS3 · AS33 · AS6	1	1901 09 00044
46	1.13/16"	38	AS3 · AS33 · AS6	1	1901 09 00046
48	1.7/8"	38	AS3 · AS33 · AS6	1	1901 09 00048
51	2"	38	AS3 · AS33 · AS6	1	1901 09 00051
52	2.1/16"	38	AS3 · AS33 · AS6	1	1901 09 00052
54	2.1/8"	38	AS3 · AS33 · AS6	1	1901 09 00054
57	2.1/4"	38	AS3 · AS33 · AS6	1	1901 09 00057
59	2.5/16"	38	AS3 · AS33 · AS6	1	1901 09 00059
60	2.3/8"	38	AS3 · AS33 · AS6	1	1901 09 00060
64	2.1/2"	38	AS3 · AS33 · AS6	1	1901 09 00064
65	2.9/16"	38	AS3 · AS33 · AS6	1	1901 09 00065
67	2.5/8"	38	AS3 · AS33 · AS6	1	1901 09 00067
68	2.11/16"	38	AS3 · AS33 · AS6	1	1901 09 00068
70	2.3/4"	38	AS3 · AS33 · AS6	1	1901 09 00070
73	2.7/8"	38	AS3 · AS33 · AS6	1	1901 09 00073
76	3"	38	AS3 · AS33 · AS6	1	1901 09 00076
79	3.1/8"	38	AS3 · AS33 · AS6	1	1901 09 00079
83	3.1/4"	38	AS3 · AS33 · AS6	1	1901 09 00083
86	3.3/8"	38	AS3 · AS33 · AS6	1	1901 09 00086
89	3.1/2"	38	AS3 · AS33 · AS6	1	1901 09 00089
92	3.5/8"	38	AS3 · AS33 · AS6	1	1901 09 00092
95	3.3/4"	38	AS3 · AS33 · AS6	1	1901 09 00095
98	3.7/8"	38	AS3 · AS33 · AS6	1	1901 09 00098
102	4"	38	AS3 · AS33 · AS6	1	1901 09 00102
105	4.1/8"	38	AS3 · AS33 · AS6	1	1901 09 00105
108	4.1/4"	38	AS3 · AS33 · AS6	1	1901 09 00108
111	4.3/8"	38	AS3 · AS33 · AS6	1	1901 09 00111
114	4.1/2"	38	AS3 · AS33 · AS6	1	1901 09 00114
121	4.3/4"	38	AS3 · AS33 · AS6	1	1901 09 00121

Bi-Metall Lochsägen HSS-E (Co8) kobaltlegiert
Bi-Metal hole saws HSS-E M42 (Co8) cobalt alloyed

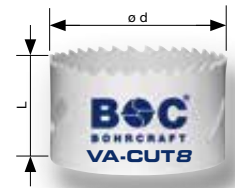

Code 1901

Ø d mm	Ø d Zoll / Inch	L mm	Aufnahmen Arbors		Artikel-Nr. Part-No.
127	5"	38	AS3 · AS33 · AS6	1	1901 09 00127
133	5.1/4"	38	AS3 · AS33 · AS6	1	1901 09 00133
140	5.1/2"	38	AS3 · AS33 · AS6	1	1901 09 00140
152	6"	38	AS3 · AS33 · AS6	1	1901 09 00152
168	6.5/8"	38	AS3 · AS33 · AS6	1	1901 09 00168
177	7"	38	AS3 · AS33 · AS6	1	1901 09 00177
210	8.9/32"	38	AS3 · AS33 · AS6	1	1901 09 00210

Kunststoff-Koffer / Plastic-Boxes

Bezeichnung Description	Teile Pieces	Inhalt Content	Artikel-Nr. Part-No.
LS 6-E	8	Ø 22 · 29 · 35 · 44 · 51 · 68 mm AS 11 (14-30 mm 6-kant / hex-shank) AS 33 (32-210 mm 6-kant / hex-shank)	1901 14 30006
RLS 9-E	11	Ø 19 · 22 · 29 · 35 · 38 · 44 · 51 · 57 · 64 mm AS 11 (14-30 mm 6-kant / hex-shank) AS 33 (32-210 mm 6-kant / hex-shank)	1901 13 30009
RLS 14-E	14	Ø 19 · 22 · 25 · 29 · 32 · 35 · 44 · 51 · 57 · 64 · 68 · 76 mm AS 11 (14-30 mm 6-kant / hex-shank) AS 33 (32-210 mm 6-kant / hex-shank)	1901 13 30014



LS 6-E



RLS 14-E



- 8 % Co Verzahnung**
- Aggressiver Schnitt
 - Extrem widerstandsfähig
 - Längere Lebensdauer

- 8 % Co tooting**
- Aggressive cut
 - Extreme wear resistant
 - Long tool life



MULTI-CUT Mehrzweck-Lochsägen HM
MULTI-CUT Multi-Purpose hole saws TCT



Code 1930

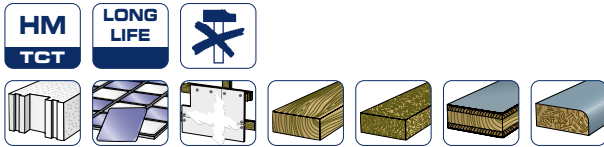

Ideales Werkzeug für Elektriker, Heizungsbauer, Sanitärinstallateure und Schreiner, da universell einsetzbar. Schnitttiefe max. 60 mm. Geeignet für Weich- und Hartholz, MDF-Platten, Sperrholz, beschichtete Holzplatten, Gipskarton, Kunststoffe, Hohlziegel und weiche Fliesen.

Nur drehend einsetzbar!

Especially designed for electricians, heating installers, plumbers, carpenters and cabinet-makers due to universal application. Cutting depth 60 mm. Suitable for soft and hard wood, MDF, plywood, coated wood boards, dry wall, plastics, gas concrete and soft tiles.

For rotary mode only!

Ø d mm	Ø d Zoll / Inch	L mm	Zähne Teeth	Aufnahmen Arbors		Artikel-Nr. Part-No.
19	3/4"	60	1	AM11	1	1930 09 00019
22	7/8"	60	1	AM11	1	1930 09 00022
25	1"	60	1	AM11	1	1930 09 00025
29	-	60	1	AM11	1	1930 09 00029
32	1.1/4"	60	1	AM33	1	1930 09 00032
35	1.3/8"	60	1	AM33	1	1930 09 00035
38	1.1/2"	60	2	AM33	1	1930 09 00038
40	1.9/16"	60	2	AM33	1	1930 09 00040
44	1.3/4"	60	2	AM33	1	1930 09 00044
51	2"	60	3	AM33	1	1930 09 00051
54	2.1/8"	60	3	AM33	1	1930 09 00054
57	2.1/4"	60	3	AM33	1	1930 09 00057
60	2.3/8"	60	3	AM33	1	1930 09 00060
64	2.1/2"	60	3	AM33	1	1930 09 00064
68	2.11/16"	60	3	AM33	1	1930 09 00068
70	2.3/4"	60	3	AM33	1	1930 09 00070
73	2.7/8"	60	3	AM33	1	1930 09 00073
76	3"	60	4	AM33	1	1930 09 00076
79	3.1/8"	60	4	AM33	1	1930 09 00079
80	-	60	4	AM33	1	1930 09 00080
83	3.1/4"	60	4	AM33	1	1930 09 00083
86	3.3/8"	60	4	AM33	1	1930 09 00086
89	3.1/2"	60	4	AM33	1	1930 09 00089
92	3.5/8"	60	4	AM33	1	1930 09 00092
102	4"	60	5	AM33	1	1930 09 00102
105	4.1/8"	60	5	AM33	1	1930 09 00105
121	4.3/4"	60	6	AM33	1	1930 09 00121
127	5"	60	6	AM33	1	1930 09 00127
152	6"	60	6	AM33	1	1930 09 00152

Kunststoff-Koffer / Plastic-Box

Bezeichnung Description	Teile Pieces	Inhalt Content	Artikel-Nr. Part-No.
LM 9	11	Ø 19 · 22 · 29 · 35 · 38 · 44 · 51 · 57 · 64 mm AM 11 (14-30 mm 6-kant / hex-shank) AM 33 (32-210 mm 6-kant / hex-shank)	1930 13 30009



MULTI-CUT Aufnahmeschäfte mit Zentrierbohrer
MULTI-CUT Arbors with pilot-drill



1

Code 1935



2

Typ Type	Schaft Shank	Zentrierbohrer Pilot-drill	Ø mm Lochsägen Ø mm Hole saws	Gewinde Thread	Bild Figure		Artikel-Nr. Part-No.
AM 11	SW 8,5	HSS	14 – 30	1/2" x 20	1	1	1935 09 00011
AM 33	SW 8,5	HSS	32 – 210	5/8" x 18	2	1	1935 09 00033

MULTI-CUT Zentrierbohrer für Aufnahmeschäfte
MULTI-CUT Pilot-drills for arbors

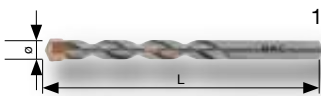

Code 1936 HM



2























Code 1936 HSS

Ausführung Version	Ø x L mm	Passend in Fitting in	Bild Figure		Artikel-Nr. Part-No.
HM	6,50 x 100	AM 11 + AM 33	1	1	1936 07 00001
HSS	6,35 x 104	AM 11 + AM 33	2	1	1936 07 00002



SÄGEBLÄTTER
SAW BLADES

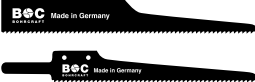

	Typ Type	Bezeichnung Description	Code	Seite Page
Stichsägeblätter / Jigsaw blades				
 	Holz und Kunststoff Wood and plastics	Stichsägeblätter mit T-Einnockenschaft Jigsaw blades with T-Shank	1960 – 1963	400 – 402
 	Metall Metal	Stichsägeblätter mit T-Einnockenschaft Jigsaw blades with T-Shank	1964 – 1965	403 – 404
 	Spezialanwendungen Special applications	Stichsägeblätter mit T-Einnockenschaft Jigsaw blades with T-Shank	1966	405
 		Sortimente Sets	1990 – 1991	405
Säbelsägeblätter / Reciprocating saw blades				
 	Holz und Kunststoff Wood and plastics	Säbelsägeblätter mit Universalschaft Reciprocating (Sabre) saw blades with universal shank	1970	406
 	Holz und Grünholz Wood and green wood	Säbelsägeblätter mit Universalschaft Reciprocating (Sabre) saw blades with universal shank	1970	406
 	Metall Metal	Säbelsägeblätter mit Universalschaft Reciprocating (Sabre) saw blades with universal shank	1971	407
 	Holz und Metall Wood and metal	Säbelsägeblätter mit Universalschaft Reciprocating (Sabre) saw blades with universal shank	1971 – 1974	408
Säbelsägeblätter / Reciprocating saw blades				
 	Spezialanwendungen Special applications	Säbelsägeblätter mit Universalschaft Reciprocating (Sabre) saw blades with universal shank	1973	409
 	Dämmstoffe Insulation materials	Säbelsägeblätter mit Universalschaft Reciprocating (Sabre) saw blades with universal shank	1974	409
Druckluftsägeblätter / Compressed air saw blades				
 		Druckluftsägeblätter für pneumatische und elektrische Maschinen Compressed air saw blades for pneumatic and electric car-body saws	1975	409
Handsägeblatt / Hack saw blade				
 		Handsägeblatt Hack saw blade	1980	405

Die Leistungsfähigkeit eines Sägeblattes hängt von der Materialqualität, der Verzahnungsart sowie der Zahngeometrie ab.

The productive power of a saw blade depends on the base material quality, the kind of toothing and the tooth geometry.

Die unterschiedlichen Verzahnungsarten stellen sich wie folgt dar:

Here is a short description about the different kind of toothing:

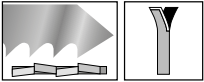

Geschränkte Zahnung für grobe Schnitte.

Side set toothing for rough cuts.

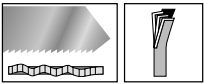

Gewellte Zahnung für feine, saubere Schnitte.

Wavy set toothing for fine and clean cuts.

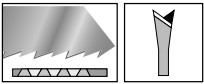

Schräg geschärfte Zahnung mit konisch geschliffenem Blattkörper für präzise, saubere Schnitte.

Conical ground blade with diagonally sharpened toothing for precise and clean cuts.

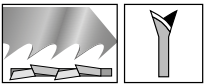

Geschränkte, schräg geschärfte Zahnung für grobe, schnelle Schnitte.

Side set, diagonally sharpened toothing for rough and quick cuts.

Die unterschiedlichen Werkstoffe erfordern eine individuelle Auswahl an Materialqualitäten. Wir unterscheiden daher zwischen:

Different materials need an individual choice of steel qualities. We distinguish between:



Legierter Werkzeugstahl

Alloyed tool steel



Hochleistungs-Schnellstahl

High speed steel



Legierter Werkzeugstahl, der an der Sägeblattschneide mit einer Hartmetallkörnung bestreut, mit Hartmetallzähnen oder mit einer HM-Leiste bestückt ist.

Alloyed tool steel with carbide coating, tungsten carbide teeth or toothed carbide coated ledge.

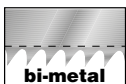

Flexible, lasergeschweißte Verbindung von legiertem, warmfesten Federbandstahl im Blattrücken und Hochleistungs-Schnellstahl im verzahnten Schneidbereich für höchste Ansprüche. Vorteile gegenüber Vollschnellstahl:

Flexible electron beam welded joint of high temperature spring band steel as backing material and high speed steel on the cutting edge to meet the highest demands given to a blade during use. Advantages against standard high speed steel blades:

- herausragende Schneidleistung
- bessere Standzeit
- hohe Bruchfestigkeit

- optimum cutting efficiency
- longer tool life
- high elasticity for high demand

Stichsägeblätter / Jigsaw blades

Bohrkraft	AEG Atlas Copco	Bosch	Festool	Makita	Metabo
1963-SPEED	-	T234X	-	-	-
1960-25	254061	T101B	S75/2,5	B11/P04606	23634
1960-K	373392	T101AO	S50K/1,4	-	23651
1960-R	346079	T101BR	-	B19/P04662	23650
1960-30	-	T301CD	-	-	23977
1960-40	274351	T101D	-	B12/P04612	23635
1960-D	373080	T101DP	S75/4FS	-	23655
1961-30	254071	T111C	-	B13/P04628	23632
1961-U	213116	T144D	S75/4	B16/P04640	23633
1961-UL	311633	T344D	S105/4	L2/P06454	23678
1961-K	346078	T244D	S75/4K	B17/P04656	23649
1964-12	254063	T118A	-	B22/P04503	23637
1965-12	340011	T118AF	HS60/1,2BI	-	23971
1965-10	274654	T318AF	HS105/1,2BI	-	23978
1965-10L	373086	-	HS155/1,2BI	-	-
1965-1825	-	T111HF	-	-	-
1964-20	254064	T118B	-	B23/P04519	23638
1964-30	274315	T127D	-	B25/P04531	23639
1966-42	-	T141HM	HM75/4,5	P38766	23652

Säbelsägeblätter / Recipro saw blades

Bohrkraft	AEG Atlas Copco	Bosch	Makita	Lenox
1970-6	323800	S644D	-	-
1970-6EL	323802	-	P05016	-
1970-4/5	323803	S1531L	-	-
1971-6L	354777	S1111DF	-	956 R
1971-18	354792	S922EF	P04880	-
1971-18L	354793	S1122EF	P04933	818 R
1971-14	354789	S922BF	P04911	614 R
1971-14L	361345	S1122BF	P04927	-
1971-14EL	354790	-	-	-
1971-10	-	S922HF	-	610 R
1971-10EL	-	-	P04983	-
1972-VEL	-	S1222VF	-	-
1973-3L	323815	S2041HM	-	-
1974-8/10	-	S3456XF	-	-
1974-Spez	-	S1120CF	P46975	960 R
1974-WM	-	S1113AWP	-	-

BOHCRAFT Code	Holz / Wood								Kunststoffe / Plastics				
	Holz Wood	Beschichtete Spanplatte Laminated chipboard	Weichholz Soft wood	Hartholz Hard wood	Sperrholz Plywood	Palettenreparatur Pallet repair	Fensterdemontage Dismantling of window frames	Laminat, Parkett Laminate, parquet	Holz mit Metallrückständen Wood with metal residues	Grünholz Green wood	Kunststoff Plastic	Plexiglas Acrylic glass	Kohlefaserverstärkter Kunststoff Carbon-fibre reinforced plastic
Stichsägeblätter / Jigsaw blades													
1960-25	☉	☉	☉	☉	☉			☉			☉		☉
1963-SPEED	☉	☉	☉	☉	☉			☉			☉	☉	☉
1960-K	☉	☉	☉		☉								
1960-R	☉	☉	☉	☉	☉						☉		☉
1960-40	☉	☉	☉	☉	☉						☉		☉
1960-D	☉	☉	☉	☉	☉						☉		☉
1960-30	☉	☉	☉	☉	☉						☉	☉	☉
1961-30	☉		☉		☉						☉		
1961-U	☉	☉	☉	☉	☉								
1965-40	☉	☉	☉	☉	☉								
1961-K	☉	☉	☉	☉	☉								
1961-UL	☉	☉	☉	☉	☉								
1964-12													
1965-12													
1964-20													
1965-10													
1965-10L													
1965-1825								☉					
1964-30											☉	☉	☉
1966-42	☉		☉								☉		☉
Säbelsägeblätter / Recipro saw blades													
1970-6	☉										☉		
1970-6EL	☉										☉		
1970-4/5										☉			
1971-6L	☉		☉	☉	☉		☉				☉		
1971-18													
1971-18L													
1971-14													
1971-14L													
1971-14EL													
1971-10													
1971-10EL													
1972-VEL							☉	☉			☉		
1973-3L	☉												☉
1974-8/10	☉		☉	☉	☉		☉				☉		
1974-Spez													☉
1974-WM													

☉ empfohlen / recommended ☉ geeignet / suitable

BOHCRAFT Code	Metalle / Metal							Eigenschaften / Characteristics						
	Edelstahl Stainless steel	Stahlrohr, -profil, Vollmaterial Steelpipe, steelprofile	Blech Sheet metal	Buntmetalle Non-ferrous metal	Aluminium Aluminium	Sandwich-Material Sandwich material	Gipskarton-Platte Gypsum board	Gasbeton Aerated concrete	Feiner Schnitt Clean cut	Grober Schnitt Rough cut	Kurvenschnitt Curve cut	Schneller Schnitt Fast cut	Parallel Schnitt Straight cut	Zahnung auf Stoß Reverse teeth
Stichsägeblätter / Jigsaw blades														
1960-25														
1963-SPEED														
1960-K														
1960-R														
1960-40														
1960-D														
1960-30														
1961-30														
1961-U														
1965-40														
1961-K														
1961-UL														
1964-12														
1965-12														
1964-20														
1965-10														
1965-10L														
1965-1825														
1964-30														
1966-42														
Säbelsägeblätter / Recipro saw blades														
1970-6														
1970-6EL														
1970-4/5														
1971-6L														
1971-18														
1971-18L														
1971-14														
1971-14L														
1971-14EL														
1971-10														
1971-10EL														
1972-VEL														
1973-3L														
1974-8/10														
1974-Spez														
1974-WM														

empfohlen / recommended geeignet / suitable

Code 1963-SPEED



HCS-Stahl, Blatt konisch geschliffen, Zähne 3-fach schräg geschärft.
Saubere und schnelle Schnitte in allen Holzarten (10 – 60 mm) und Kunststoffen.

HCS-steel, conically ground and teeth 3-times sharpened.
Extreme clean and fast cuts in all wood types (10 – 60 mm) and plastics.

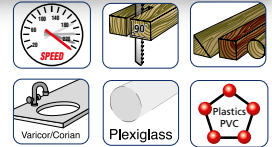

Zahnteilung Tooth pitch	Schnittlänge Toothed length	ähnlich / sim. Ref.-No. Bosch		Artikel-Nr. Part-No.
2,5	91 mm	T234X	5	1963 16 00001

Code 1960-25



CV-Stahl, Blatt konisch geschliffen, Zähne schräg geschärft.
Saubere Schnitte in allen Holzarten und Kunststoffen bis 30 mm.

CV-steel, conically ground blade, teeth diagonally sharpened.
Clean cuts in all wood types and plastics up to 30 mm.



Zahnteilung Tooth pitch	Schnittlänge Toothed length	ähnlich / sim. Ref.-No. Bosch			Artikel-Nr. Part-No.
2,5	75 mm	T101B	5	-	1960 16 00001
2,5	75 mm	T101B	-	25	1960 03 00001

Code 1960-K



CV-Stahl, Blatt konisch geschliffen, Zähne schräg geschärft, spitz verzahnt.
Kurven-Blatt für Hart-, Weich- und Sperrholz.

CV-steel, conically ground blade, teeth diagonally sharpened, tapered toothing.
Saw blade for curve cutting in hard, soft and plywood.

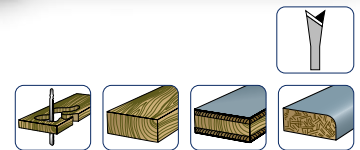

Zahnteilung Tooth pitch	Schnittlänge Toothed length	ähnlich / sim. Ref.-No. Bosch		Artikel-Nr. Part-No.
1,35	50 mm	T101AO	5	1960 16 00002

Code 1960-R

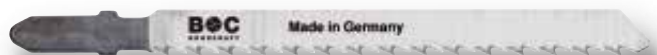

CV-Stahl, Blatt konisch geschliffen, Zähne schräg geschärft.
Zahnung auf Stoß für saubere splitterfreie Oberflächenschnitte
in allen Holzarten und Kunststoffen.

CV-steel, conically ground blade, teeth diagonally sharpened.
Reverse teeth for clean, splinterfree surface cuts in all wood types and plastics.



Zahnteilung Tooth pitch	Schnittlänge Toothed length	ähnlich / sim. Ref.-No. Bosch		Artikel-Nr. Part-No.
2,5	75 mm	T101BR	5	1960 16 00003

STICHSÄGEBLÄTTER
JIGSAW BLADES

Code **1960-30**



CV-Stahl, Blatt konisch geschliffen, Zähne schräg geschärft.
Extra langes Blatt für saubere und gerade Schnitte in allen Holzarten und Kunststoffen.
CV-steel, conically ground blade, teeth diagonally sharpened.
Extra long blade for clean and straight cuts in all wood types and plastics.



Zahnteilung Tooth pitch	Schnittlänge Toothed length	ähnlich / sim. Ref.-No. Bosc		Artikel-Nr. Part-No.
3,0	105 mm	T301CD	5	1960 16 00004

Code **1960-40**



CV-Stahl, Blatt konisch geschliffen, Zähne schräg geschärft.
Saubere Schnitte in allen Holzarten und Kunststoffen.
CV-steel, conically ground blade, teeth diagonally sharpened.
Clean cuts in all wood types and plastics.



Zahnteilung Tooth pitch	Schnittlänge Toothed length	ähnlich / sim. Ref.-No. Bosch		Artikel-Nr. Part-No.
4,0	75 mm	T101D	5	1960 16 00005

Code **1960-D**

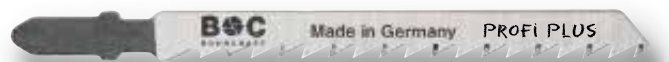

CV-Stahl, Blatt konisch geschliffen, Zähne schräg geschärft.
Extra dickes Blatt für saubere und gerade Schnitte in Holz und Kunststoff.
CV-steel, conically ground blade, teeth diagonally sharpened.
Special thick blade for clean and straight cuts in wood and plastics.

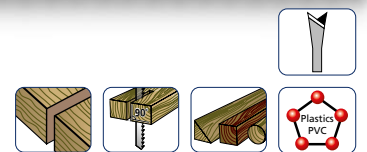

Zahnteilung Tooth pitch	Schnittlänge Toothed length	ähnlich / sim. Ref.-No. Bosch		Artikel-Nr. Part-No.
4,0	75 mm	T101DP	5	1960 16 00006

Code **1961-30**



CV-Stahl, Zähne geschliffen und geschränkt.
Für Weichholz und Kunststoffe.
CV-steel, sharpened and side set teeth.
For soft wood and plastics.

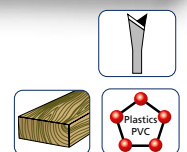

Zahnteilung Tooth pitch	Schnittlänge Toothed length	ähnlich / sim. Ref.-No. Bosch			Artikel-Nr. Part-No.
3,0	75 mm	T111C	5	-	1961 16 00001
3,0	75 mm	T111C	-	25	1961 03 00001

STICHSÄGEBLÄTTER
JIGSAW BLADES

Code **1961-U**



CV-Stahl, Zähne geschränkt und schräg geschärft.
Universal-Blatt für schnelle Schnitte in allen Holzarten.

CV-steel, side set and diagonally sharpened teeth.
Universal saw blade for quick cuts in all wood types.



Zahnteilung Tooth pitch	Schnittlänge Toothed length	ähnlich / sim. Ref.-No. Bosch			Artikel-Nr. Part-No.
4,0	75 mm	T144D	5	-	1961 16 00002
4,0	75 mm	T144D	-	25	1961 03 00002

Code **1961-UL**



CV-Stahl, Zähne geschränkt und schräg geschärft.
Universal-Blatt für schnelle Schnitte in allen Holzarten (5 – 80 mm).

CV-steel, side set and diagonally sharpened teeth.
Universal saw blade for quick cuts in all wood types (5 – 80 mm).



Zahnteilung Tooth pitch	Schnittlänge Toothed length	ähnlich / sim. Ref.-No. Bosch		Artikel-Nr. Part-No.
4,0	105 mm	T344D	5	1961 16 00004

Code **1961-K**



CV-Stahl, Zähne geschränkt und schräg geschärft.
Kurven-Blatt für schnelle Schnitte in allen Holzarten.

CV-steel, side set and diagonally sharpened teeth.
Saw blade for curve and quick cutting in all wood types.



Zahnteilung Tooth pitch	Schnittlänge Toothed length	ähnlich / sim. Ref.-No. Bosch		Artikel-Nr. Part-No.
4,0	75 mm	T244D	5	1961 16 00003



STICHSÄGEBLÄTTER
JIGSAW BLADES

Code **1964-12**



HSS, Zähne gewellt.
Für Stahl und Bleche (1,2 bis 2,0 mm).

HSS, wavy set teeth.
For steel and sheet metals (1,2 to 2,0 mm).

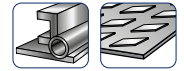

Zahnteilung Tooth pitch	Schnittlänge Toothed length	ähnlich / sim. Ref.-No. Bosch		Artikel-Nr. Part-No.
1,2	55 mm	T118A	5	1964 16 00001

Code **1964-20**



HSS, Zähne gewellt.
Für Stahl, Aluminium und Buntmetalle.

HSS, wavy set teeth.
For steel, aluminium and non-ferrous metals.

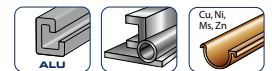

Zahnteilung Tooth pitch	Schnittlänge Toothed length	ähnlich / sim. Ref.-No. Bosch		Artikel-Nr. Part-No.
2,0	55 mm	T118B	5	1964 16 00002

Code **1964-30**



HSS, Zähne geschränkt.
Für Stahl, Buntmetalle, Aluminium und Kunststoffe.

HSS, side set teeth.
For steel, non-ferrous metals, aluminium and plastics.



Zahnteilung Tooth pitch	Schnittlänge Toothed length	ähnlich / sim. Ref.-No. Bosch		Artikel-Nr. Part-No.
3,0	75 mm	T127D	5	1964 16 00003

Code **1965-12**



Bi-Metall, Zähne gewellt.
Flexibles Blatt für Stahl und **rostfreie Stähle** (1,2 – 2,0 mm).

Bi-metal, wavy set teeth.
Flexible saw blade for steel and **stainless steel** (1,2 – 2,0 mm).

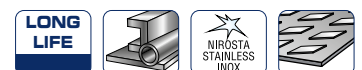

Zahnteilung Tooth pitch	Schnittlänge Toothed length	ähnlich / sim. Ref.-No. Bosch		Artikel-Nr. Part-No.
1,2	55 mm	T118AF	5	1965 16 00001

STICHSÄGEBLÄTTER
JIGSAW BLADES

Code **1965-1825**



Bi-Metall, Zähne geschränkt.
Vario-verzahntes flexibles Blatt für **Stahl und Holz** mit Metallrückständen.
Bi-metal, side set teeth.
Vario toothed flexible saw blade for **steel and wood** with metal residues.



Zahnteilung Tooth pitch	Schnittlänge Toothed length	ähnlich / sim. Ref.-No. Bosch		Artikel-Nr. Part-No.
1,8 – 2,5	75 mm	T111HF	5	1965 16 00002

Code **1965-10**

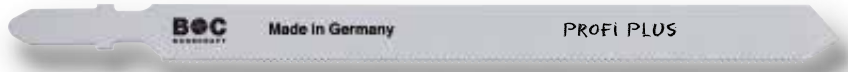

Bi-Metall, Zähne gewellt.
Langes flexibles Blatt für Stahl (1,0 – 1,8 mm) und **Sandwich-Material bis 80 mm**.
Bi-metal, wavy set teeth.
Long flexible saw blade for steel (1,0 – 1,8 mm) and **sandwich-material up to 80 mm**.

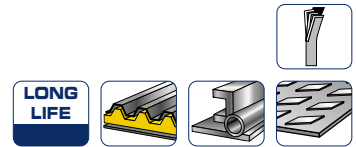

Zahnteilung Tooth pitch	Schnittlänge Toothed length	ähnlich / sim. Ref.-No. Bosch		Artikel-Nr. Part-No.
1,0	105 mm	T318AF	5	1965 16 00003

Code **1965-10L**



Bi-Metall, Zähne gewellt.
Extra langes flexibles Blatt speziell für den Fassadenbau zur Bearbeitung von **Sandwich-Materialien bis 120 mm**.
Bi-metal, wavy set teeth.
Extra long flexible saw blade especially for facade constructions to cut **sandwich-materials up to 120 mm**.



Zahnteilung Tooth pitch	Schnittlänge Toothed length	ähnlich / sim. Ref.-No. Bosch		Artikel-Nr. Part-No.
1,0	155 mm	-	5	1965 16 00004

STICHSÄGEBLÄTTER
JIGSAW BLADES

Code **1966-42**



Hartmetall Zahnung.
Geeignet für GFK-Produkte, **Hartholz** und Gasbeton.

Tungsten carbide teeth.
Suitable for Glass-fibre reinforced products, **hard wood** and aerated concrete.

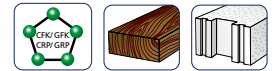

Zahnteilung Tooth pitch	Schnittlänge Toothed length	ähnlich / sim. Ref.-No. Bosch		Artikel-Nr. Part-No.
4,2	75 mm	T141HM	1	1966 16 00002

Stichsägeblätter-Sortimente
Jigsaw blades assortments

Kunststoff-Kassette / Plastic-Box

Bezeichnung Description	Inhalt Content	Zahnteilung Tooth pitch	Schnittlänge Toothed length	~ Ref.-No. Bosch	Artikel-Nr. Part-No.	
St-W10	10-tlg./ 10-pcs.	1 x 1961-K	4,00	75 mm	T244D	1990 13 30010
		1 x 1960-K	1,35	50 mm	T101AO	
		1 x 1960-R	2,50	75 mm	T101BR	
		2 x 1960-25	2,50	75 mm	T101B	
		2 x 1961-30	3,00	105 mm	T111C	
		3 x 1961-U	4,00	75 mm	T144D	



Kunststoff-Kassette / Plastic-Box

Bezeichnung Description	Inhalt Content	Zahnteilung Tooth pitch	Schnittlänge Toothed length	~ Ref.-No. Bosch	Artikel-Nr. Part-No.	
St-M10	10-tlg./ 10-pcs.	2 x 1964-12	1,2	55 mm	T118A	1991 13 30010
		2 x 1964-20	2,0	55 mm	T118B	
		2 x 1965-12	1,2	55 mm	T118AF	
		2 x 1964-30	3,0	75 mm	T127D	
		2 x 1965-1825	1,8 - 2,5	75 mm	T111HF	



Handsägeblatt
Hack saw blade

Code **1980-2430**



Bi-Metall
Bi-metal

Code	Länge length	Zähne / Zoll Teeth / inch	Blattausführung Blade version		Artikel-Nr. Part-No.
1980-2430	300	24	gewellt/wavy set	100*	1980 03 00001

* Kleinere Mengen werden lose geliefert / * Smaller quantities will be delivered bulk

Säbelsägeblätter für Holz und Kunststoff
Recipro saw blades for wood and plastics

Code **1970-6 • 1970-6EL**



CV-Stahl, Zähne geschränkt (**1970-6 schräg geschärft**).
Blatt für alle Holzarten, Kunststoffe und Gips.

CV-steel, side set teeth (**1970-6 diagonally sharpened**).
Saw blade for all wood types, plastics and gypsum.

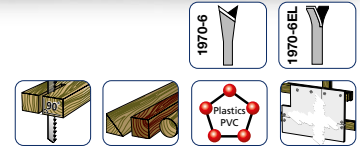

Code	Zähne / Zoll Teeth / inch	Schnittlänge Toothed length	ähnlich / sim. Ref.-No. Bosch		Artikel-Nr. Part-No.
1970-6	6	130 mm	S644D	5	1970 16 00001
1970-6EL	6	280 mm	S1344D	5	1970 16 00002

Säbelsägeblätter für Holz und Grünholz
Recipro saw blades for wood and green wood

Code **1970-4/5**



CV-Stahl, Zähne geschränkt, schräg geschärft und **induktiv gehärtet**.
Spezialblatt für Grünholz.

CV-steel, side set teeth, diagonally sharpened and **induction hardened teeth**.
Special saw blade for green wood.

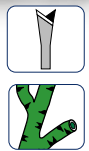

Code	Zähne / Zoll Teeth / inch	Schnittlänge Toothed length	ähnlich / sim. Ref.-No. Bosch		Artikel-Nr. Part-No.
1970-4/5	4/5	220 mm	S1531L	5	1970 16 00004

Code **1970-SPEED**



CV-Stahl, Blatt konisch, Zähne 3-fach schräg geschliffen und induktiv gehärtet
(Extrem scharf geschliffen). **Extra dickes Blatt, dadurch sehr stabil.**
Für saubere, schnelle und aggressive Schnitte in trockenem und nassem
Holz. **Besonders für aggressive Schnitte in Grünholz geeignet.**

CV-Steel, Conical Blade, Teeth 3-times diagonally sharpened.
Teeth hardened by in induction (extremely sharp grounded).

Very stable due to special thickness of blade.

For clean, fast and aggressive cuts in dry and wet wood.

Especially suitable for aggressive cuts in green wood.

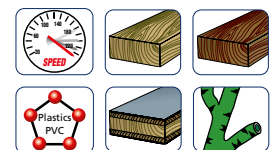

Code	Zähne / Zoll Teeth / inch	Schnittlänge Toothed length	ähnlich / sim. Ref.-No. Bosch		Artikel-Nr. Part-No.
1970-Speed	6	255 mm	-	2	1970 16 00005

SÄBELSÄGEBLÄTTER
RECIPRO SAW BLADES

Code **1971-18 • 1971-18L**



Bi-Metall, Zähne gewellt.

Universal-Blatt für Stahl und rostfreie Stähle (1,5 – 2,5 mm).

Bi-metal, wavy set teeth.

Universal saw blade for steel and stainless steel (1,5 – 2,5 mm).



Code	Zähne / Zoll Teeth / inch	Schnittlänge Toothed length	ähnlich / sim. Ref.-No. Bosch		Artikel-Nr. Part-No.
1971-18	18	130 mm	S922EF	5	1971 16 00001
1971-18L	18	180 mm	S1122EF	5	1971 16 00002

Code **1971-14 • 1971-14L • 1971-14EL**



Bi-Metall, Zähne gewellt.

Universal-Blatt für Stahl, rostfreie Stähle

(2,5 – 3,5 mm) und Buntmetalle.

Bi-metal, wavy set teeth.

Universal saw blade for steel, stainless steel

(2,5 – 3,5 mm) and non-ferrous metals.

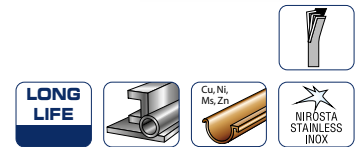

Code	Zähne / Zoll Teeth / inch	Schnittlänge Toothed length	ähnlich / sim. Ref.-No. Bosch			Artikel-Nr. Part-No.
1971-14	14	130 mm	S922BF	5	-	1971 16 00003
1971-14	14	130 mm	S922BF	-	20	1971 03 00003
1971-14L	14	180 mm	S1122BF	5	-	1971 16 00004
1971-14L	14	180 mm	S1122BF	-	20	1971 03 00004
1971-14EL	14	230 mm	-	5	-	1971 16 00005

Code **1971-10 • 1971-10EL**



Bi-Metall, Zähne geschränkt.

Universal-Blatt für Stahl, rostfreie Stähle

(3,5 – 5,0 mm) und Buntmetalle.

Bi-metal, side set teeth.

Universal saw blade for steel, stainless steel

(3,5 – 5,0 mm) and non-ferrous metal.



Code	Zähne / Zoll Teeth / inch	Schnittlänge Toothed length	ähnlich / sim. Ref.-No. Bosch		Artikel-Nr. Part-No.
1971-10	10	130 mm	S922HF	5	1971 16 00006
1971-10EL	10	260 mm	-	5	1971 16 00007

SÄBELSÄGEBLÄTTER
RECIPRO SAW BLADES

Code 1971-6L

Bi-Metall, Zähne gefräst und geschränkt.
Für schnelle Schnitte in allen Holzarten, sowie in Kunststoff.
Auch zur Fensterdemontage geeignet.

Bi-metal, teeth milled and side set.
For fast and straight cuts in all wood types and plastics.
Also suitable for window dismantling.



Code	Zähne / Zoll Teeth / inch	Schnittlänge Toothed length	ähnlich / sim Ref.-No. Bosch		Artikel-Nr. Part-No.
1971-6L	6	205 mm	S1111DF	5	1971 16 00009

Code 1972-VEL

Bi-Metall, Zähne geschränkt.
Vario-verzahntes Blatt für alle Holzarten mit **Metallrückständen**;
Stahl ab 2,5 mm. Besonders geeignet für Palettenreparaturen.

Bi-metal, side set teeth.
Vario-toothed saw blade for all wood types with **metal residues**;
steel from 2,5 mm thickness. Especially designed for pallet construction.



Code	Zähne / Zoll Teeth / inch	Schnittlänge Toothed length	ähnlich / sim Ref.-No. Bosch		Artikel-Nr. Part-No.
1972-VEL	10/14	260 mm	S1222VF	5	1972 16 00003

Code 1974-8/10

Bi-Metall, Zähne gefräst und geschränkt.
Extra dickes Blatt für gerade Schnitte in allen Holzarten mit Metallrückständen;
Stahl ab 3 mm. **Speziell für die Fensterdemontage.**

Bi-metal, teeth milled and side set.
Special thick saw blade for straight cuts in all wood types of wood
with metal residues; steel > 3 mm. **Especially for window dismantling.**



Code	Zähne / Zoll Teeth / inch	Schnittlänge Toothed length	ähnlich / sim Ref.-No. Bosch		Artikel-Nr. Part-No.
1974-8/10	8/10	180 mm	S3456XF	5	1974 16 00007

Code 1974-Spez

Bi-Metall, Zähne gefräst und geschränkt.
Speziälsägeblatt für Demontage- und Rettungsarbeiten.
Für gerade Schnitte in Stahl ab 3 mm und Holz mit Metallrückständen.

Bi-metal, side set teeth.
Special saw-blade for dismantling, rescue and salvage. For straight
cuts in steel bigger than 3 mm and all wood types with metal residues.



Code	Zähne / Zoll Teeth / inch	Schnittlänge Toothed length	ähnlich / sim Ref.-No. Bosch		Artikel-Nr. Part-No.
1974-Spez	10	205 mm	S1120CF	3	1974 16 00004



Säbelsägeblätter für diverse Materialien
Recipro saw blades for different materials

Code **1974-WM**

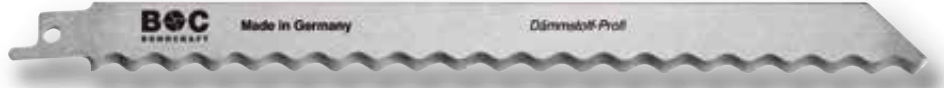

CV-Stahl, doppelter Wellenschliff.

Speziälsägeblatt für die Bearbeitung von **Dämmstoffen** im Innenausbau und bei der Wärmeisolierung. **Für schnelle und saubere Schnitte** in Mineralwolle, Schäume, Styrodur, Styropor, Leder, Gummi, Papier, Teppich bis zu 175 mm.

CV-steel, double wave cut.

Special saw-blade for interior fitting **insulation** and thermal insulation.

For quick and clean cuts in mineral rock wool, foams (EPS, PUR), Polystyrene, leather, rubber, paper, carpet up to 175 mm. and glass-fibre reinforced products.



Code	Zähne teeth	Schnittlänge Toothed length	ähnlich / sim Ref.-No. Bosch		Artikel-Nr. Part-No.
1974-WM	Wellenschliff Wavy grounded	205 mm	S1113AWP	2	1974 16 00006

Code **1973-3L**



Hartmetall-Zähne.

Blatt für **Hartholz**, Gasbeton und GFK-Produkte.

Tungsten carbide teeth.

Saw blade for **hard wood**, aerated concrete and glass-fibre reinforced products.

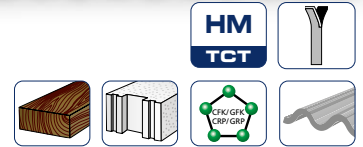

Code	Zähne / Zoll Teeth / inch	Schnittlänge Toothed length	ähnlich / sim Ref.-No. Bosch		Artikel-Nr. Part-No.
1973-3L	3	280 mm	S2041HM	1	1973 16 00001

Druckluftsägeblätter für pneumatische und elektrische Maschinen
Compressed-air saw blades for pneumatic and electric car-body saws

Code **1975-01**



Bi-Metall. Passend zu: Pneutec, Ober, Shinano.

Bi-metal. Suitable for: Pneutec, Ober, Shinano.

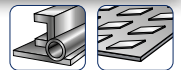

Code	Zähne / Zoll Teeth / inch	Blattausführung Blade version	ähnlich / sim Ref.-No. Bosch		Artikel-Nr. Part-No.
1975-0114	14	gewellt / wavy set	-	5	1975 07 00007
1975-0124	24	gewellt / wavy set	-	5	1975 07 00001
1975-0132	32	gewellt / wavy set	-	5	1975 07 00002

Code **1975-02**



Bi-Metall. Passend zu: SIG, Flex.

Bi-metal. Suitable for: SIG, Flex.

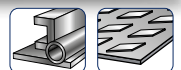





Code	Zähne / Zoll Teeth / inch	Blattausführung Blade version	ähnlich / sim Ref.-No. Bosch		Artikel-Nr. Part-No.
1975-0214	14	gewellt / wavy set	-	5	1975 07 00005
1975-0224	24	gewellt / wavy set	-	5	1975 07 00003
1975-0232	32	gewellt / wavy set	-	5	1975 07 00004



SCHRAUBLOCHSTANZEN (BLECHLOCHER)
SCREW-HOLE PUNCHES (KNOCKOUT PUNCHES)



SCHRAUBLOCHSTANZEN (BLECHLOCHER) SCREW-HOLE PUNCHES (KNOCKOUT PUNCHES)

		Bezeichnung Description	Code	Seite Page
Schraublochstanzen und Zubehör / Screw-hole punches and accessories				
		Schraublochstanzen mit 3-Punkt-Anschnitt Screw-hole punches with 3-point cutting tip	1915	412
		Ersatzschrauben für Schraublochstanzen Replacement screws for screw-hole punches	1916	413
		Sortimente Sets	1915	412

Schraublochstanzen (Blechlöcher) mit 3-Punkt-Anschnitt

Screw-hole punches (Knockout punches) with 3-point cutting tip



Code **1915**



Zum gratfreien und exakten Lochen von Blechen aus unterschiedlichen Materialien, wie Aluminium, Eisen, Edelstahl, Kupfer oder Messing. Maximale Materialstärke = 2 mm.

For a burr-free and exact punching of sheet made of different materials like aluminium, iron, stainless steel, copper and brass. Maximum material thickness = 2 mm.

$\varnothing d$ mm	Durchgangsmaße Through dimensions		Kanal- & Rohrgröße Conduit & pipe size	\varnothing Zoll \varnothing Inch	Zugschraube Draw-in bolt		Artikel-Nr. Part-No.
12,7	M 12	PG 7		1/2"	MF 8 x 1.0	1	1915 03 01270
15,2		PG 9			MF 8 x 1.0	1	1915 03 01520
16,0					MF 8 x 1.0	1	1915 03 01600
16,5	M 16				MF 10 x 1.0	1	1915 03 01650
18,6		PG 11			MF 10 x 1.0	1	1915 03 01860
19,0				3/4"	MF 10 x 1.0	1	1915 03 01900
20,4	M 20	PG 13,5			MF 10 x 1.0	1	1915 03 02040
22,5		PG 16	1/2"	7/8"	MF 10 x 1.0	1	1915 03 02250
24,0					MF 10 x 1.0	1	1915 03 02400
25,0					MF 10 x 1.0	1	1915 03 02500
25,4	M 25			1"	MF 10 x 1.0	1	1915 03 02540
26,0					MF 12 x 1.5	1	1915 03 02600
28,3		PG 21	3/4"		MF 12 x 1.5	1	1915 03 02830
30,0					MF 12 x 1.5	1	1915 03 03000
32,0					MF 12 x 1.5	1	1915 03 03200
32,5	M 32				MF 12 x 1.5	1	1915 03 03250
35,0				1.3/8"	MF 12 x 1.5	1	1915 03 03500
37,0		PG 29			MF 12 x 1.5	1	1915 03 03700
40,0					MF 12 x 1.5	1	1915 03 04000
40,5	M 40				MF 16 x 1.5	1	1915 03 04050
45,0					MF 16 x 1.5	1	1915 03 04500
47,0		PG 36			MF 16 x 1.5	1	1915 03 04700
50,0			1.1/2"		MF 16 x 1.5	1	1915 03 05000
50,5	M 50				MF 16 x 1.5	1	1915 03 05050
60,0		PG 48			MF 16 x 1.5	1	1915 03 06000
63,5	M 63			2.1/2"	MF 16 x 1.5	1	1915 03 06350

BC ABS-Box / BC ABS-Box

Bezeichnung Description	Teile Pieces	Inhalt Content	Artikel-Nr. Part-No.
BL 2835	6	je 1x \varnothing 18,3 · 32,0 · 35,0 mm 2x Zugschraube / Replacement screw MF 12 x 1,5 1x Blechschälbohrer / Sheet metal drill Gr. 2 / 6 – 20 mm	1915 13 30006



Kunststoff-Koffer / Plastic-Box

Bezeichnung Description	Teile Pieces	Inhalt Content	Artikel-Nr. Part-No.
BL 1663	12	je 1x \varnothing 16,5 · 20,4 · 25,4 · 32,5 · 40,5 · 50,5 · 63,5 mm je 1 Zugschraube / Replacement screw MF 10 x 1,0 · MF 12 x 1,5 · MF 16 x 1,5 1x Blechschälbohrer / Sheet metal drill Gr. 2 / 6 – 20 mm 1x Schneidpaste / Cutting paste BP 20	1915 13 30012



Ersatzschrauben für Schraublochstanzen (Blechlocher)
Replacement screws for screw-hole punches (Knockout punches)



Code **1916**

MF

Größe Size	Für Schraublochstanzen For screw-hole punches		Artikel-Nr. Part-No.
MF 8 x 1,0	12,7 – 16,0 mm	1	1916 03 00810
MF 10 x 1,0	16,5 – 25,4 mm	1	1916 03 01010
MF 12 x 1,5	26,0 – 40,0 mm	1	1916 03 01215
MF 16 x 1,5	40,5 – 63,5 mm	1	1916 03 01615





	Bezeichnung Description	Code	Seite Page
Schrauber-Bits + Halter 1/4" Antrieb / Screwdriver-bits and holders 1/4" drive			
	Schrauber-Bits 1/4" Screwdriver-bits 1/4"	6100 – 6230	417 – 424
	Schrauber-Bits 1/4", TiN-beschichtet Screwdriver-bits 1/4" TiN-coated	6121 – 6141	417 – 420
	Farbring Schrauber-Bits 1/4" Colour Ring screwdriver-bits 1/4"	6123 – 6143	418 – 421
	Sortimente Sets	6900	424
	Bithalter für Schrauber-Bits 1/4" Bitholders for screwdriver-bits 1/4"	6300 – 6330	425
Halter 1/4" Antrieb / Holders 1/4" drive			
	Winkel-Vorsätze für 1/4" Bits und für Bohrer L-shaped drivers for 1/4" bits and for drills	6350 6351	426
Steckschlüssel + Adapter 1/4" Antrieb / Sockets + adaptors 1/4" drive			
	Steckschlüsseleinsätze 1/4", 45 mm Länge Sockets 1/4", 45 mm length	6500	427
	Steckschlüsseleinsätze 1/4", 65 mm Länge Sockets 1/4", 65 mm length	6500-65	427
	Steckschlüsseleinsätze 1/4", unmagnetisch Sockets 1/4", non-magnetic	6501	428
	Steckschlüsseleinsätze mit Federring für rostfreie Schrauben Sockets with spring for stainless screws	6502	428
	Eindrehwerkzeug für Stockschrauben Fixing-tool for setting hanger bolts	6505	428
	Adapter Adaptors	6400 6645-1/4"	429
Schrauber-Bits + Zubehör 5/16" Antrieb / Screwdriver-bits + accessories 5/16" drive			
	Schrauber-Bits 5/16" Sechskant Screwdriver-bits 5/16" hexagon	6710 – 6720	430 – 431
Schrauber-Bits + Zubehör 10 mm Antrieb / Screwdriver-bits and holders 10 mm drive			
	Schrauber-Bits 10 mm Sechskant Screwdriver-bits 10 mm hexagon	6614 – 6624	432 – 433
	Adapter mit Kugel für 10 mm Sechskant Adaptors with ball for 10 mm hexagon	6645	433

Standard-Bits



- für die meisten Schraubarbeiten geeignet
- zähgehärtete Ausführung
- breites Programm aller gängigen Bit-Sorten
- verschiedene Längen erhältlich

Standard-Bits



- optimal for most screwing demands
- special heat-treatment
- wide bit-range available
- different lengths available

ACR-Bits (Anti Cam-out Rippen)



- griffige Bit-Spitze, dadurch bester Halt im Schraubkopf
- hervorragende Drehmoment-Übertragung
- reduzierte Auswurfkräfte (Cam-out Effekt)
- geringerer Verschleiß
- geringere Anpresskraft erforderlich

ACR-Bits (Anti Cam-out ribs)



- better grip in the screw-head due to special bit-tip with ribs
- optimal torque transmission
- reduced "Cam-out forces"
- less wear
- less pressing force necessary

TiN-Bits



- hohe Oberflächenhärte durch Titanitrit-Beschichtung
- besonders für Serienschraubungen in der Industrie geeignet
- optimale Kernzähigkeit
- starke Verschleißschutz-Schicht
- höhere Standzeit
- optimaler Korrosionsschutz

TiN-Bits



- high surface hardness due to titanium-coating
- suitable for continuous heavy use in industry
- optimal tenacity of the core
- improved wear-resisting layer
- longer tool life
- good corrosion protection

Farbring-Bits



- Lieferbar in PH / PZ / Tx

Colour Ring-Bits



- Available in PH / PZ / Tx

Code **6120**



Bits für Phillips-Schrauben.
Bits for Phillips screws.

Größe Size	L mm		Artikel-Nr. Part-No.		Artikel-Nr. Part-No.
PH 1	25	100	6120 15 00125	10	6120 11 10125
PH 2	25	100	6120 15 00225	10	6120 11 10225
PH 3	25	100	6120 15 00325	10	6120 11 10325
PH 1	50	50	6120 15 00150	-	-
PH 2	50	50	6120 15 00250	-	-
PH 3	50	50	6120 15 00350	-	-
PH 1	75	25	6120 15 00175	-	-
PH 2	75	25	6120 15 00275	-	-
PH 3	75	25	6120 15 00375	-	-
PH 1	100	25	6120 15 00110	-	-
PH 2	100	25	6120 15 00210	-	-
PH 3	100	25	6120 15 00310	-	-
PH 1	150	25	6120 15 00115	-	-
PH 2	150	25	6120 15 00215	-	-
PH 3	150	25	6120 15 00315	-	-

Code **6121-TiN**



TiN-Bits für Phillips-Schrauben.
TiN-bits for Phillips screws.

Größe Size	L mm		Artikel-Nr. Part-No.
PH 1	25	100	6121 15 00125
PH 2	25	100	6121 15 00225
PH 3	25	100	6121 15 00325
PH 1	50	50	6121 15 00150
PH 2	50	50	6121 15 00250
PH 3	50	50	6121 15 00350

Code **6122-ACR**



Hochzähe ACR-Bits für Phillips-Schrauben.
(Besserer Grip durch Bit-Spitze mit ACR-Rippen)
High flexible ACR-bits for Phillips screws.
(Better grip due to special bit-tip with ribs)

Größe Size	L mm		Artikel-Nr. Part-No.
PH 1	25	100	6122 15 00125
PH 2	25	100	6122 15 00225
PH 3	25	100	6122 15 00325

Code **6120-red.**



Bits für Phillips-Schrauben, reduzierte Ausführung
mit extra schmaler Spitze.
Bits for Phillips screws (Grabber), reduced nose for drywall.

Größe Size	L mm		Artikel-Nr. Part-No.		Artikel-Nr. Part-No.
PH 2	25	100	6120 15 02025	10	6120 11 12025

Code **6123 SB**



Farbring-Bits für Phillips-Schrauben.

Colour Ring-Bits for Phillips screws.

Größe Size	L mm		Artikel-Nr. Part-No.
PH 1	25	10	6123 11 10125
PH 2	25	10	6123 11 10225
PH 3	25	10	6123 11 10325

Code **6130**



Bits für Pozidriv-Schrauben.

Bits for Pozidriv screws.

Größe Size	L mm		Artikel-Nr. Part-No.		Artikel-Nr. Part-No.
PZ 0	25	100	6130 15 00025	-	-
PZ 1	25	100	6130 15 00125	10	6130 11 10125
PZ 2	25	100	6130 15 00225	10	6130 11 10225
PZ 3	25	100	6130 15 00325	10	6130 11 10325
PZ 4	32	100	6130 15 00432	-	-
PZ 1	50	50	6130 15 00150	-	-
PZ 2	50	50	6130 15 00250	-	-
PZ 3	50	50	6130 15 00350	-	-
PZ 1	75	25	6130 15 00175	-	-
PZ 2	75	25	6130 15 00275	-	-
PZ 3	75	25	6130 15 00375	-	-
PZ 1	100	25	6130 15 00110	-	-
PZ 2	100	25	6130 15 00210	-	-
PZ 3	100	25	6130 15 00310	-	-
PZ 1	150	25	6130 15 00115	-	-
PZ 2	150	25	6130 15 00215	-	-
PZ 3	150	25	6130 15 00315	-	-

Code **6131-TiN**



TiN-Bits für Pozidriv-Schrauben.

TiN-bits for Pozidriv screws.

Größe Size	L mm		Artikel-Nr. Part-No.
PZ 1	25	100	6131 15 00125
PZ 2	25	100	6131 15 00225
PZ 3	25	100	6131 15 00325
PZ 1	50	50	6131 15 00150
PZ 2	50	50	6131 15 00250
PZ 3	50	50	6131 15 00350

Code **6132-ACR**



Hochzähe ACR-Bits für Pozidriv-Schrauben.
(Besserer Grip durch Bit-Spitze mit ACR-Rippen)
 High flexible ACR-bits for Pozidriv screws.
(Better grip due to special bit-tip with ribs)

Größe Size	L mm		Artikel-Nr. Part-No.
PZ 1	25	100	6132 15 00125
PZ 2	25	100	6132 15 00225
PZ 3	25	100	6132 15 00325

Code **6130-red.**



Bits für Pozidriv-Schrauben, reduzierte Ausführung mit extra schmaler Spitze.
 Bits for Pozidriv screws (Grabber), reduced nose for drywall.

Größe Size	L mm		Artikel-Nr. Part-No.
PZ 2	25	100	6130 15 02025

Code **6133 SB**



Farbring-Bits für Pozidriv-Schrauben.
 Colour Ring-Bits for Pozidriv screws.

Größe Size	L mm		Artikel-Nr. Part-No.
PZ 1	25	10	6133 11 10125
PZ 2	25	10	6133 11 10225
PZ 3	25	10	6133 11 10325

Code **6100**



Bits für Schlitzschrauben.
 Bits for slotted-head screws.

Größe Size	L mm		Artikel-Nr. Part-No.
3,0 x 0,5	25	100	6100 15 03025
3,5 x 0,5	25	100	6100 15 03525
4,0 x 0,5	25	100	6100 15 04025
4,5 x 0,6	25	100	6100 15 04525
5,5 x 0,8	25	100	6100 15 05525
6,0 x 1,0	25	100	6100 15 06025
6,5 x 1,2	25	100	6100 15 06525
8,0 x 1,2	25	100	6100 15 08025

SCHRAUBER-BITS
SCREWDRIVER-BITS

Code **6140**



Bits für Tx-Schrauben.

Bits for Tx screws.

Größe Size	L mm		Artikel-Nr. Part-No.		Artikel-Nr. Part-No.
Tx 6	25	100	6140 15 00625	-	-
Tx 7	25	100	6140 15 00725	-	-
Tx 8	25	100	6140 15 00825	-	-
Tx 9	25	100	6140 15 00925	-	-
Tx 10	25	100	6140 15 01025	10	6140 11 11025
Tx 15	25	100	6140 15 01525	10	6140 11 11525
Tx 20	25	100	6140 15 02025	10	6140 11 12025
Tx 25	25	100	6140 15 02525	10	6140 11 12525
Tx 27	25	100	6140 15 02725	-	-
Tx 30	25	100	6140 15 03025	10	6140 11 13025
Tx 40	25	100	6140 15 04025	10	6140 11 14025
Tx 45	25	100	6140 15 04525	-	-
Tx 50	25	100	6140 15 05025	-	-
Tx 55	25	100	6140 15 05525	-	-
Tx 7	50	50	6140 15 00750	-	-
Tx 8	50	50	6140 15 00850	-	-
Tx 9	50	50	6140 15 00950	-	-
Tx 10	50	50	6140 15 01050	-	-
Tx 15	50	50	6140 15 01550	-	-
Tx 20	50	50	6140 15 02050	-	-
Tx 25	50	50	6140 15 02550	-	-
Tx 27	50	50	6140 15 02750	-	-
Tx 30	50	50	6140 15 03050	-	-
Tx 40	50	50	6140 15 04050	-	-
Tx 45	50	50	6140 15 04550	-	-
Tx 50	50	50	6140 15 05050	-	-
Tx 55	50	50	6140 15 05550	-	-
Tx 6	75	25	6140 15 00675	-	-
Tx 7	75	25	6140 15 00775	-	-
Tx 8	75	25	6140 15 00875	-	-
Tx 9	75	25	6140 15 00975	-	-
Tx 10	75	25	6140 15 01075	-	-
Tx 15	75	25	6140 15 01575	-	-
Tx 20	75	25	6140 15 02075	-	-
Tx 25	75	25	6140 15 02575	-	-
Tx 27	75	25	6140 15 02775	-	-
Tx 30	75	25	6140 15 03075	-	-
Tx 40	75	25	6140 15 04075	-	-

Code **6141-TiN**



TiN-Bits für Tx-Schrauben.

TiN-bits for Tx screws.

Größe Size	L mm		Artikel-Nr. Part-No.
Tx 10	25	100	6141 15 01025
Tx 15	25	100	6141 15 01525
Tx 20	25	100	6141 15 02025
Tx 25	25	100	6141 15 02525
Tx 30	25	100	6141 15 03025
Tx 40	25	100	6141 15 04025

SCHRAUBER-BITS
SCREWDRIVER-BITS

Code **6143 SB**



Farbring-Bits für Tx-Schrauben.

Colour Ring-Bits for Tx screws.

Größe Size	L mm		Artikel-Nr. Part-No.
Tx 10	25	10	6143 11 11025
Tx 15	25	10	6143 11 11525
Tx 20	25	10	6143 11 12025
Tx 25	25	10	6143 11 12525
Tx 27	25	10	6143 11 12725
Tx 30	25	10	6143 11 13025
Tx 40	25	10	6143 11 14025
Tx 50	25	10	6143 11 15025

Code **6150**



Bits mit Loch für Tx-Schrauben mit Sicherheitsstift.

Bits with hole for Tx screws with safety-pin.

Größe Size	L mm		Artikel-Nr. Part-No.
TR 6	25	100	6150 15 00625
TR 7	25	100	6150 15 00725
TR 8	25	100	6150 15 00825
TR 9	25	100	6150 15 00925
TR 10	25	100	6150 15 01025
TR 15	25	100	6150 15 01525
TR 20	25	100	6150 15 02025
TR 25	25	100	6150 15 02525
TR 27	25	100	6150 15 02725
TR 30	25	100	6150 15 03025
TR 40	25	100	6150 15 04025
TR 45	25	100	6150 15 04525
TR 50	25	100	6150 15 05025
TR 55	25	100	6150 15 05525
TR 6	50	50	6150 15 00650
TR 7	50	50	6150 15 00750
TR 8	50	50	6150 15 00850
TR 9	50	50	6150 15 00950
TR 10	50	50	6150 15 01050
TR 15	50	50	6150 15 01550
TR 20	50	50	6150 15 02050
TR 25	50	50	6150 15 02550
TR 27	50	50	6150 15 02750
TR 30	50	50	6150 15 03050
TR 40	50	50	6150 15 04050
TR 6	75	25	6150 15 00675
TR 7	75	25	6150 15 00775
TR 8	75	25	6150 15 00875
TR 9	75	25	6150 15 00975
TR 10	75	25	6150 15 01075
TR 15	75	25	6150 15 01575
TR 20	75	25	6150 15 02075
TR 25	75	25	6150 15 02575
TR 27	75	25	6150 15 02775
TR 30	75	25	6150 15 03075
TR 40	75	25	6150 15 04075



Code **6160**



Größe Size	L mm		Artikel-Nr. Part-No.
SW 1,5	25	100	6160 15 01525
SW 2,0	25	100	6160 15 00225
SW 2,5	25	100	6160 15 02525
SW 3,0	25	100	6160 15 00325
SW 4,0	25	100	6160 15 00425
SW 5,0	25	100	6160 15 00525
SW 6,0	25	100	6160 15 00625
SW 7,0	25	100	6160 15 00725
SW 8,0	25	100	6160 15 00825
SW 10,0	25	100	6160 15 01025
SW 1/8"	25	100	6160 15 01825
SW 5/32"	25	100	6160 15 05325
SW 3/16"	25	100	6160 15 03125
SW 1,5	50	50	6160 15 01550
SW 2,0	50	50	6160 15 00250

Bits für Innensechskant-Schrauben.

Bits for inside hexagon screws.

Größe Size	L mm		Artikel-Nr. Part-No.
SW 2,5	50	50	6160 15 02550
SW 3,0	50	50	6160 15 00350
SW 4,0	50	50	6160 15 00450
SW 5,0	50	50	6160 15 00550
SW 6,0	50	50	6160 15 00650
SW 8,0	50	50	6160 15 00850
SW 10,0	50	50	6160 15 01050
SW 1,5	75	25	6160 15 01575
SW 2,0	75	25	6160 15 00275
SW 2,5	75	25	6160 15 02575
SW 3,0	75	25	6160 15 00375
SW 4,0	75	25	6160 15 00475
SW 5,0	75	25	6160 15 00575
SW 6,0	75	25	6160 15 00675
SW 8,0	75	25	6160 15 00875
SW 10,0	75	25	6160 15 01075

Code **6170**



Größe Size	L mm		Artikel-Nr. Part-No.
SW 2,0	25	100	6170 15 00225
SW 2,5	25	100	6170 15 02525
SW 3,0	25	100	6170 15 00325
SW 4,0	25	100	6170 15 00425

Bits mit Loch für Innensechskant-Schrauben mit Sicherheitsstift.

Bits with hole for inside hexagon screws with safety-pin.

Größe Size	L mm		Artikel-Nr. Part-No.
SW 5,0	25	100	6170 15 00525
SW 6,0	25	100	6170 15 00625
SW 8,0	25	100	6170 15 00825
SW 10,0	25	100	6170 15 01025

Code **6180**



Größe Size	L mm		Artikel-Nr. Part-No.
SW 2,5	25	100	6180 15 02525
SW 3,0	25	100	6180 15 00325
SW 4,0	25	100	6180 15 00425

Kugelkopf-Bits für Innensechskant-Schrauben.

Ballpoint-Bits for inside hexagon screws.

Größe Size	L mm		Artikel-Nr. Part-No.
SW 5,0	25	100	6180 15 00525
SW 6,0	25	100	6180 15 00625

Code **6190**



Größe Size	L mm		Artikel-Nr. Part-No.
# 0	25	100	6190 15 00025
# 1	25	100	6190 15 00125
# 2	25	100	6190 15 00225
# 3	25	100	6190 15 00325

Bits für Robertson Vierkant-Schrauben.

Bits for Robertson square screws.

Größe Size	L mm		Artikel-Nr. Part-No.
# 0	50	50	6190 15 00050
# 1	50	50	6190 15 00150
# 2	50	50	6190 15 00250
# 3	50	50	6190 15 00350

Code **6200**

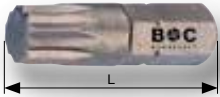

Größe Size	L mm		Artikel-Nr. Part-No.
M 4	25	100	6200 15 00425
M 5	25	100	6200 15 00525

Bits für XZN Vielzahn-Schrauben.

Bits for XZN multi-spline screws.

Größe Size	L mm		Artikel-Nr. Part-No.
M 6	25	100	6200 15 00625
M 8	25	100	6200 15 00825

Code **6210**



Größe Size	L mm		Artikel-Nr. Part-No.
# 0	25	100	6210 15 00025
# 1	25	100	6210 15 00125
# 2	25	100	6210 15 00225

Bits für TRI-WING-Schrauben (Dreiflügel-Schrauben).

Bits for TRI-WING screws (Threewing screws).

Größe Size	L mm		Artikel-Nr. Part-No.
# 3	25	100	6210 15 00325
# 4	25	100	6210 15 00425
# 5	25	100	6210 15 00525

Code **6220**



Größe Size	L mm		Artikel-Nr. Part-No.
# 4	25	100	6220 15 00425
# 5	25	100	6220 15 00525
# 6	25	100	6220 15 00625

Bits für TORQ-SET-Schrauben (Vierflügel-Schrauben).

Bits for TORQ-SET screws (Fourwing screws).

Größe Size	L mm		Artikel-Nr. Part-No.
# 8	25	100	6220 15 00825
# 10	25	100	6220 15 01025

Code **6230**



Größe Size	L mm		Artikel-Nr. Part-No.
# 4	25	100	6230 15 00425
# 6	25	100	6230 15 00625

Bits für Spanner-Schrauben (Zweiloch).

Bits for Spanner screws.

Größe Size	L mm		Artikel-Nr. Part-No.
# 8	25	100	6230 15 00825
# 10	25	100	6230 15 01025





BC Mini-Boxen / BC Mini-Boxes

Bezeichnung Description	Teile Pieces	Inhalt Content	Artikel-Nr. Part-No.
PB 7-HEX	7	6-kant / Hexagon SW 2 · SW 2,5 · SW 3 · SW 4 · SW 5 · SW 6 + Halter / Holder	6900 14 30072
PB 10-PZ	10	3 x Pozidriv PZ1 · PZ2 · PZ3 + Halter / Holder	6900 14 30105
PB 10-TX	10	Tx T8 · T9 · T10 · T15 · T20 · 2 x T25 · T30 · T40 + Halter / Holder	6900 14 30104



BC Kunststoff-Boxen / BC Plastic-Boxes

Bezeichnung Description	Teile Pieces	Inhalt Content	Display 	Artikel-Nr. Part-No.
PB 32	32	Phillips PH1 · 2 x PH2 · PH3 Pozidriv 2 x PZ1 · 5 x PZ2 · 3 x PZ3 Tx mit Loch / with hole 2 x TR10 · TR20 · TR30 · TR40 4 x TR15 · TR25 Adapter / Adaptor Halter / Holder	12	6900 14 30031
PB 32-3	32	Phillips PH1 · 2 x PH2 · PH3 Pozidriv PZ1 · 2 x PZ2 · PZ3 Schlitz / Slotted 3,0 · 4,0 · 5,0 · 6,0 6-kant / Hexagon SW 3 · SW 4 · SW 5 · SW 6 Tx T10 · T15 · T20 · T25 · T27 · T30 · T40 Tx mit Loch / with hole TR10 · TR15 · TR20 · TR25 · TR27 · TR30 · TR40 Adapter / Adaptor Halter / Holder	12	6900 14 30032



BC Display

BC Kunststoff-Box / BC Plastic-Box

Bezeichnung Description	Teile Pieces	Inhalt Content	Display 	Artikel-Nr. Part-No.
PB 24	24	Umschaltknarre „Mini“ / Ratchet "Mini" Phillips PH1 · PH2 Pozidriv PZ1 · PZ2 Tx mit Loch / with hole TR10 · TR15 · TR20 · TR25 · TR30 · TR40 6-kant / Hexagon SW4 · SW5 · SW6 Schlitz / Slotted 4,5 · 6,5 Stecknüsse / Sockets SW 6 · SW7 · SW8 · SW 10 · SW11 · SW13 Adapter / Adaptor Halter / Holder	12	6900 14 30023



BC Display

Code **6300**



Magnet-Bithalter, verchromte Messinghülse.
Magnetic bitholders, chromated brass barrel.

Antrieb Drive	L mm		Artikel-Nr. Part-No.
1/4" E 6,3	60	25	6300 15 01060
1/4" E 6,3	75	25	6300 15 01075

Code **6310**



Universal **Magnet-Bithalter**, mit Sprengring.
Magnetic bitholders, with spring clip.

Antrieb Drive	L mm		Artikel-Nr. Part-No.
1/4" E 6,3	60	25	6310 15 01160
1/4" E 6,3	75	25	6310 15 01175
1/4" E 6,3	150	5	6310 15 01115
1/4" E 6,3	200	5	6310 15 01120
1/4" E 6,3	250	5	6310 15 01125

Code **6330**



Universal **Magnet-Bithalter** „Schnellspann-System“.
Magnetic bitholders, "Quick-Lock".

Antrieb Drive	L mm		Artikel-Nr. Part-No.
1/4" E 6,3	60	25	6330 15 01160
1/4" E 6,3	75	25	6330 15 01175
1/4" E 6,3	150	5	6330 15 01115
1/4" E 6,3	200	5	6330 15 01120

Code **6330-SDS**



Magnet-Bithalter „Schnellspann-System“.
Magnetic bitholders, "Quick-Lock".

Antrieb Drive	L mm		Artikel-Nr. Part-No.
SDS-plus	100	5	6330 15 01110



BITHALTER
BITHOLDER

1/4" | Winkelschraubvorrichtung HD PRO 90, für Bits 1/4"
L-shaped driver HD PRO 90, for all 1/4" bits

Code **6350**



- Ideal um unter geringem Platzbedarf zu schrauben
- Besonders für den Einsatz in Akkuschaubern geeignet
- Sehr stabile Handwerker-Ausführung
- Max. Drehmoment: 40 Nm

- Easier access to narrow spaces
- Heavy Duty version especially suitable for impact drivers
- Durability and long life due to high torque
- Max. torque: 40 Nm

Antrieb Drive	L 1 mm	L 2 mm		Artikel-Nr. Part-No.
1/4" E 6,3	175	65	1	6350 16 00001

1/4" | Winkelbohrvorrichtung HD PRO 100
L-shaped driver HD PRO 100

Code **6351**

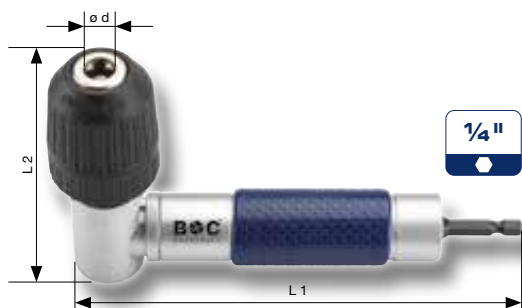

- Ideal um unter geringem Platzbedarf zu bohren
- Besonders für den Einsatz in Akkuschaubern geeignet
- Sehr stabile Handwerker-Ausführung
- Max. 2.100 U/min.
- Stahl = Max. Ø 10 mm
- Holz = Max. Ø 16 mm

- Easier access to narrow spaces
- Especially suitable for impact drivers
- Heavy Duty version
- Max. 2.100 rpm.
- Steel = Ø 10 mm max.
- Wood = Ø 16 mm max.

Ø d mm	Antrieb Drive	L 1 mm	L 2 mm		Artikel-Nr. Part-No.
1 - 10	1/4" E 6,3	175	97	1	6351 16 00001



Code **6500**

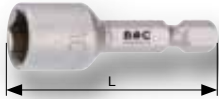

Magnetische Steckschlüsseinsätze 1/4" Antrieb.
Für Außensechskant-Schrauben.

Magnetic sockets 1/4" drive.
For outside hexagon screws.

Größe Size	L mm		Artikel-Nr. Part-No.
SW 4,0	45	25	6500 15 00445
SW 5,0	45	25	6500 15 00545
SW 5,5	45	25	6500 15 05545
SW 6,0	45	25	6500 15 00645
SW 7,0	45	25	6500 15 00745
SW 8,0	45	25	6500 15 00845
SW 9,0	45	25	6500 15 00945
SW 10,0	45	25	6500 15 01045

Größe Size	L mm		Artikel-Nr. Part-No.
SW 11,0	45	25	6500 15 01145
SW 12,0	45	25	6500 15 01245
SW 13,0	45	25	6500 15 01345
SW 14,0	45	25	6500 15 01445
SW 1/4"	45	25	6500 15 14045
SW 5/16"	45	25	6500 15 05145
SW 3/8"	45	25	6500 15 03845

BC Runddose / BC Round-Box

Bezeichnung Description	Teile Pieces	Inhalt Content	Artikel-Nr. Part-No.
RST 7	7	SW 7 / SW 8 / SW 10 / SW 12 / SW 13 / SW 3/8" / SW 1/4"	6500 14 30007



Code **6500-65**



Magnetische Steckschlüsseinsätze 1/4" Antrieb.
Für Außensechskant-Schrauben.

Magnetic sockets 1/4" drive.
For outside hexagon screws.

Größe Size	L mm		Artikel-Nr. Part-No.
SW 5,5	65	25	6500 15 05565
SW 6,0	65	25	6500 15 00665
SW 7,0	65	25	6500 15 00765
SW 8,0	65	25	6500 15 00865
SW 10,0	65	25	6500 15 01065
SW 12,0	65	25	6500 15 01265

Größe Size	L mm		Artikel-Nr. Part-No.
SW 13,0	65	25	6500 15 01365
SW 17,0	65	25	6500 15 01765
SW 1/4"	65	25	6500 15 14065
SW 5/16"	65	25	6500 15 05165
SW 3/8"	65	25	6500 15 03865

BC SB-QuadroPack / BC Display-QuadroPack

Bezeichnung Description	Teile Pieces	Inhalt Content	Artikel-Nr. Part-No.
RST 3-65	3	SW 1/4" · SW 5/16" · SW 3/8"	6500 03 30003
RST 4-65	4	SW 7 · SW 8 · SW 10 · SW 13	6500 03 30004
RST 8-65	8	SW 5,5 · SW 6 · SW 7 · SW 8 · SW 10 · SW 12 · SW 13 · SW 17	6500 03 30008



1/4" | Steckschlüsseinsätze, 1/4" Antrieb
Sockets, 1/4" drive

Code **6501**



Steckschlüsseinsätze (**ohne Magnet**) 1/4" Antrieb.
Für Außensechskant-Schrauben.

Sockets (**non magnetic**) 1/4" drive.
For outside hexagon screws.

Größe Size	L mm		Artikel-Nr. Part-No.
SW 6,0	65	25	6501 15 00665
SW 7,0	65	25	6501 15 00765
SW 8,0	65	25	6501 15 00865
SW 10,0	65	25	6501 15 01065
SW 13,0	65	25	6501 15 01365
SW 1/4"	65	25	6501 15 14065
SW 3/8"	65	25	6501 15 03865

Code **6502**

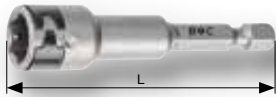

Steckschlüsseinsätze mit Federring 1/4" Antrieb.
Für **rostfreie** Schrauben.

Sockets with spring 1/4" drive.
For **stainless** screws.

Größe Size	L mm		Artikel-Nr. Part-No.
SW 7,0	65	25	6502 15 00765
SW 8,0	65	25	6502 15 00865
SW 10,0	65	25	6502 15 01065
SW 3/8"	65	25	6502 15 03865

1/4" | Eindrehwerkzeug für Stockschrauben
Fixing-Tool for setting hanger bolts

Code **6505**



Eindrehwerkzeug für Stockschrauben.
Mit Innengewinde für Stockschrauben.

Fixing-Tool for setting hanger bolts.
For screws with metric thread end.



Größe Size	L mm		Artikel-Nr. Part-No.
M 6	50	5	6505 15 00650
M 8	50	5	6505 15 00850
M 10	50	5	6505 15 01050

STECKSCHLÜSSEL
SOCKETS

Code **6400**

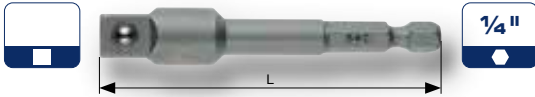

Adapter für Stecknüsse.
Adaptors for sockets.

	L mm		Artikel-Nr. Part-No.
1/4"	25	5	6400 15 01425
1/4"	50	5	6400 15 01450
3/8"	50	5	6400 15 03850
1/2"	50	5	6400 15 01250

BC SB-Pack / BC Display-Pack

Bezeichnung Description	Teile Pieces	Inhalt Content		Artikel-Nr. Part-No.
A 3	3	1/4" · 3/8" · 1/2" x 50 mm	1	6400 11 00003



Code **6645-1/4"**



1/2" Adapter für 1/4" Bits.
1/2" Adaptor for 1/4" bits.

			Artikel-Nr. Part-No.
1/4"	1/2"	5	6645 15 01214

Code **6710**



Größe Size	L mm		Artikel-Nr. Part-No.
5,5 x 0,8	41	5	6710 15 05541
6,5 x 1,2	41	5	6710 15 06541
8,0 x 1,2	41	5	6710 15 08041

Bits für Schlitzschrauben.
Bits for slotted-head screws.

Größe Size	L mm		Artikel-Nr. Part-No.
10,0 x 1,6	41	5	6710 15 01041
12,0 x 2,0	41	5	6710 15 01241

Code **6712**



Größe Size	L mm		Artikel-Nr. Part-No.
PH 1	32	5	6712 15 00132
PH 2	32	5	6712 15 00232
PH 3	32	5	6712 15 00332
PH 4	38	5	6712 15 00438

Bits für Phillips-Schrauben.
Bits for Phillips screws.

Größe Size	L mm		Artikel-Nr. Part-No.
PH 1	70	5	6712 15 00170
PH 2	70	5	6712 15 00270
PH 3	70	5	6712 15 00370

Code **6713**



Größe Size	L mm		Artikel-Nr. Part-No.
PZ 1	32	5	6713 15 00132
PZ 2	32	5	6713 15 00232
PZ 3	32	5	6713 15 00332
PZ 4	38	5	6713 15 00438

Bits für Pozidriv-Schrauben.
Bits for Pozidriv screws.

Größe Size	L mm		Artikel-Nr. Part-No.
PZ 1	70	5	6713 15 00170
PZ 2	70	5	6713 15 00270
PZ 3	70	5	6713 15 00370

Code **6714**



Größe Size	L mm		Artikel-Nr. Part-No.
Tx 20	35	5	6714 15 02035
Tx 25	35	5	6714 15 02535
Tx 27	35	5	6714 15 02735
Tx 30	35	5	6714 15 03035
Tx 40	35	5	6714 15 04035
Tx 45	35	5	6714 15 04535
Tx 50	35	5	6714 15 05035
Tx 55	35	5	6714 15 05535

Bits für Tx-Schrauben.
Bits for Tx screws.

Größe Size	L mm		Artikel-Nr. Part-No.
Tx 20	70	5	6714 15 02070
Tx 25	70	5	6714 15 02570
Tx 27	70	5	6714 15 02770
Tx 30	70	5	6714 15 03070
Tx 40	70	5	6714 15 04070
Tx 45	70	5	6714 15 04570
Tx 50	70	5	6714 15 05070
Tx 55	70	5	6714 15 05570

Code **6715**



Größe Size	L mm		Artikel-Nr. Part-No.
TR 20	35	5	6715 15 02035
TR 25	35	5	6715 15 02535
TR 27	35	5	6715 15 02735
TR 30	35	5	6715 15 03035
TR 40	35	5	6715 15 04035
TR 45	35	5	6715 15 04535
TR 50	35	5	6715 15 05035
TR 55	35	5	6715 15 05535

Bits mit Loch für Tx-Schrauben mit Sicherheitsstift.

Bits with hole for Tx screws with safety-pin.

Größe Size	L mm		Artikel-Nr. Part-No.
TR 20	70	5	6715 15 02070
TR 25	70	5	6715 15 02570
TR 27	70	5	6715 15 02770
TR 30	70	5	6715 15 03070
TR 40	70	5	6715 15 04070
TR 45	70	5	6715 15 04570
TR 50	70	5	6715 15 05070
TR 55	70	5	6715 15 05570

Code **6716**



Größe Size	L mm		Artikel-Nr. Part-No.
SW 4,0	30	5	6716 15 00430
SW 5,0	30	5	6716 15 00530
SW 6,0	30	5	6716 15 00630
SW 8,0	30	5	6716 15 00830
SW 10,0	30	5	6716 15 01030

Bits für Innensechskant-Schrauben.

Bits for inside hexagon screws.

Größe Size	L mm		Artikel-Nr. Part-No.
SW 4,0	70	5	6716 15 00470
SW 5,0	70	5	6716 15 00570
SW 6,0	70	5	6716 15 00670
SW 8,0	70	5	6716 15 00870

Code **6720**



Größe Size	L mm		Artikel-Nr. Part-No.
M 6	30	5	6720 15 00630
M 8	30	5	6720 15 00830

Bits für XZN Vielzahn-Schrauben.

Bits for XZN multi-spline screws.

Größe Size	L mm		Artikel-Nr. Part-No.
M 10	30	5	6720 15 01030
M 12	30	5	6720 15 01230



Code **6614**



Größe Size	L mm		Artikel-Nr. Part-No.
Tx 10	30	5	6614 15 01030
Tx 15	30	5	6614 15 01530
Tx 20	30	5	6614 15 02030
Tx 25	30	5	6614 15 02530
Tx 27	30	5	6614 15 02730
Tx 30	30	5	6614 15 03030
Tx 40	30	5	6614 15 04030
Tx 45	30	5	6614 15 04530
Tx 50	30	5	6614 15 05030
Tx 55	30	5	6614 15 05530

Bits für Tx-Schrauben.

Bits for Tx screws.

Größe Size	L mm		Artikel-Nr. Part-No.
Tx 10	75	5	6614 15 01075
Tx 15	75	5	6614 15 01575
Tx 20	75	5	6614 15 02075
Tx 25	75	5	6614 15 02575
Tx 27	75	5	6614 15 02775
Tx 30	75	5	6614 15 03075
Tx 40	75	5	6614 15 04075
Tx 45	75	5	6614 15 04575
Tx 50	75	5	6614 15 05075
Tx 55	75	5	6614 15 05575

Code **6615**



Größe Size	L mm		Artikel-Nr. Part-No.
TR 10	30	5	6615 15 01030
TR 15	30	5	6615 15 01530
TR 20	30	5	6615 15 02030
TR 25	30	5	6615 15 02530
TR 27	30	5	6615 15 02730
TR 30	30	5	6615 15 03030
TR 40	30	5	6615 15 04030
TR 45	30	5	6615 15 04530
TR 50	30	5	6615 15 05030
TR 55	30	5	6615 15 05530

Bits mit Loch für Tx-Schrauben mit Sicherheitsstift.

Bits with hole for Tx screws with safety-pin.

Größe Size	L mm		Artikel-Nr. Part-No.
TR 10	75	5	6615 15 01075
TR 15	75	5	6615 15 01575
TR 20	75	5	6615 15 02075
TR 25	75	5	6615 15 02575
TR 27	75	5	6615 15 02775
TR 30	75	5	6615 15 03075
TR 40	75	5	6615 15 04075
TR 45	75	5	6615 15 04575
TR 50	75	5	6615 15 05075
TR 55	75	5	6615 15 05575

Code **6616**

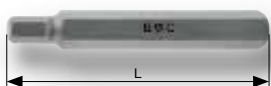

Größe Size	L mm		Artikel-Nr. Part-No.
SW 4	30	5	6616 15 00430
SW 5	30	5	6616 15 00530
SW 6	30	5	6616 15 00630
SW 7	30	5	6616 15 00730
SW 8	30	5	6616 15 00830
SW 10	30	5	6616 15 01030
SW 12	30	5	6616 15 01230
SW 14	30	5	6616 15 01430

Bits für Innensechskant-Schrauben.

Bits for inside hexagon screws.

Größe Size	L mm		Artikel-Nr. Part-No.
SW 4	75	5	6616 15 00475
SW 5	75	5	6616 15 00575
SW 6	75	5	6616 15 00675
SW 7	75	5	6616 15 00775
SW 8	75	5	6616 15 00875
SW 10	75	5	6616 15 01075
SW 12	75	5	6616 15 01275
SW 14	75	5	6616 15 01475

Code **6617**

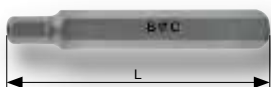

Größe Size	L mm		Artikel-Nr. Part-No.
SW 4	30	5	6617 15 00430
SW 5	30	5	6617 15 00530
SW 6	30	5	6617 15 00630
SW 7	30	5	6617 15 00730
SW 8	30	5	6617 15 00830
SW 10	30	5	6617 15 01030
SW 12	30	5	6617 15 01230

Bits mit Loch für Innensechskant-Schrauben mit Sicherheitsstift.

Bits with hole for inside hexagon screws with safety-pin.

Größe Size	L mm		Artikel-Nr. Part-No.
SW 4	75	5	6617 15 00475
SW 5	75	5	6617 15 00575
SW 6	75	5	6617 15 00675
SW 7	75	5	6617 15 00775
SW 8	75	5	6617 15 00875
SW 10	75	5	6617 15 01075
SW 12	75	5	6617 15 01275



Code **6620**



Bits für XZN Vielzahn-Schrauben.

Bits for XZN multi-spline screws.

Größe Size	L mm		Artikel-Nr. Part-No.
M 5	30	5	6620 15 00530
M 6	30	5	6620 15 00630
M 8	30	5	6620 15 00830
M 10	30	5	6620 15 01030
M 12	30	5	6620 15 01230
M 14	30	5	6620 15 01430

Größe Size	L mm		Artikel-Nr. Part-No.
M 5	75	5	6620 15 00575
M 6	75	5	6620 15 00675
M 8	75	5	6620 15 00875
M 10	75	5	6620 15 01075
M 12	75	5	6620 15 01275
M 14	75	5	6620 15 01475

Code **6624**



Bits für Ribe-Schrauben.

Bits for Ribe screws.

Größe Size	L mm		Artikel-Nr. Part-No.
4	30	5	6624 15 00430
5	30	5	6624 15 00530
6	30	5	6624 15 00630
7	30	5	6624 15 00730
8	30	5	6624 15 00830
9	30	5	6624 15 00930
10	30	5	6624 15 01030
12	30	5	6624 15 01230
13	30	5	6624 15 01330
14	30	5	6624 15 01430
16	30	5	6624 15 01630

Größe Size	L mm		Artikel-Nr. Part-No.
4	75	5	6624 15 00475
5	75	5	6624 15 00575
6	75	5	6624 15 00675
7	75	5	6624 15 00775
8	75	5	6624 15 00875
9	75	5	6624 15 00975
10	75	5	6624 15 01075
12	75	5	6624 15 01275
13	75	5	6624 15 01375
14	75	5	6624 15 01475
16	75	5	6624 15 01675

Adapter für 10 mm Bits | 10 mm
Adaptor for 10 mm bits | mm

Code **6645**



Adapter mit Kugel für 10 mm Sechskant.

Adaptor with ball for 10 mm hexagon.

			Artikel-Nr. Part-No.
10 mm	3/8"	5	6645 15 03810
10 mm	1/2"	5	6645 15 01210





K 13 leer



KS 6-K leer



K 170 leer

Für Spiralbohrer DIN 338 / For twist drills DIN 338

Bezeichnung Description	Teile Pieces	Inhalt Content		Artikel-Nr. Part-No.
K 10 leer	19	Ø 1,0 – 10,0 mm x 0,5 mm	1	0081 15 20019
K 13 leer	25	Ø 1,0 – 13,0 mm x 0,5 mm	1	0081 15 20025
K 24 leer	24	Ø 1,0 – 10,5 mm x 0,5 mm + 3,3 · 4,2 · 6,8 · 10,2 mm	1	0081 15 20024
K 591 leer	51	Ø 1,0 – 6,0 mm x 0,1 mm	1	0081 15 20050
K 601 leer	41	Ø 6,0 – 10,0 mm x 0,1 mm	1	0081 15 20041
K 170 leer	170	Ø 1,0 – 10,0 mm x 0,5 mm	1	0081 15 20170



Für Gewindewerkzeuge / For thread cutting tools

Bezeichnung Description	Teile Pieces	Inhalt Content		Artikel-Nr. Part-No.
MGB 7-K leer	7	Maschinengewindebohrer / Machine taps DIN 371/376 · M3 – M12	1	0081 15 20007
MGB 14-K leer	14	Maschinengewindebohrer / Machine taps DIN 371/376 · M3 – M12 + 2,5 · 3,3 · 4,2 · 5,0 · 6,8 · 8,5 · 10,2 mm, DIN 338	1	0081 15 20014
EGB 15-K leer	15	Einschnittgewindebohrer / Short machine taps DIN 352 · M3 – M12 + 2,5 · 3,3 · 4,2 · 5,0 · 6,8 · 8,5 · 10,2 mm, DIN 338 + Windeisen / Tap wrench DIN 1814 Gr. 1,5	1	0081 15 20015
G 12-K leer	21	HGB-Sätze 3-tlg. / Hand-tap sets 3 pcs. DIN 352 · M3 – M12	1	0081 15 20021
GK 12-K leer	28	HGB-Sätze 3-tlg. / Hand-tap sets 3 pcs. DIN 352 · M3 – M12 + 2,5 · 3,3 · 4,2 · 5,0 · 6,8 · 8,5 · 10,2 mm, DIN 338	1	0081 15 20028



Für Kegelsenker, Blechschäl- und Stufenbohrer
For countersinks, sheet metal drills & step drills

Bezeichnung Description	Teile Pieces	Inhalt Content		Artikel-Nr. Part-No.
KS 5-K leer	5	Kegelsenker / Countersinks DIN 335 6,3 · 10,4 · 16,5 · 20,5 · 25,0 mm	1	0081 15 20005
KS 6-K leer	6	Kegelsenker / Countersinks DIN 335 6,3 · 8,3 · 10,4 · 12,4 · 16,5 · 20,5 mm	1	0081 15 20006
FS 6-K leer	6	Flachsenker / Flat countersinks DIN 373 M3 – M10	1	0081 15 20004
B 3-K leer	3	Blechschälbohrer / Sheet metal drills Größe / Size: 1 · 2 · 3	1	0081 15 20003
STB 3-K leer	3	Stufenbohrer / Step drills Größe / Size: 1 · 2A · 3A	1	0081 15 20013



LEERKASSETTEN
EMPTY BOXES



M 13 leer



M 170 leer



GW 12 leer

Für Spiralbohrer DIN 338 / For twist drills DIN 338

Bezeichnung Description	Teile Pieces	Inhalt Content		Artikel-Nr. Part-No.
M 10 leer	19	Ø 1,0 – 10,0 mm x 0,5 mm	1	0080 15 20019
M 13 leer	25	Ø 1,0 – 13,0 mm x 0,5 mm	1	0080 15 20025
M 24 leer	24	Ø 1,0 – 10,5 mm x 0,5 mm + 3,3 · 4,2 · 6,8 · 10,2 mm	1	0080 15 20024
M 591 leer	50	Ø 1,0 – 5,9 mm x 0,1 mm	1	0080 15 20051
M 601 leer	41	Ø 6,0 – 10,0 mm x 0,1 mm	1	0080 15 20041
M 170 leer	170	Ø 1,0 – 10,0 mm x 0,5 mm Ø 1,0 – 8,0 mm = 10 St. / pcs. Ø 8,5 – 10,0 mm = 5 St. / pcs.	1	0080 15 21170
M 220 leer	220	Ø 1,0 – 13,0 mm x 0,5 mm + 3,3 · 4,2 mm Ø 1,0 – 8,0 mm = 10 St. / pcs. Ø 8,5 – 13,0 mm = 5 St. / pcs.	1	0080 15 20220



Für Gewindewerkzeuge / For thread cutting tools

Bezeichnung Description	Teile Pieces	Inhalt Content		Artikel-Nr. Part-No.
GW 12 leer	44	HGB-Sätze 3-tlg. / Hand-tap sets 3 pcs. DIN 352 + Schneideisen / Circuar dies M3 – M12 Halter / Holder DIN 225 20 x 5 · 20 x 7 · 25 x 9 · 30 x 11 · 38 x 14 Windeisen / Tap wrench DIN 1814 Gr. 1 + 2 Gewindeschablone / Gauge Schraubendreher / Screwdriver Kernlochbohrer / core hole drills DIN 338	1	0080 15 20044
GW 20 leer	54	HGB-Sätze 3-tlg. / Hand-tap sets 3 pcs. DIN 352 + Schneideisen / Circuar dies M3 – M20 Halter / Holder DIN 225 20 x 5 · 20 x 7 · 25 x 9 · 30 x 11 · 38 x 14 · 45 x 18 Windeisen / Tap wrench DIN 1814 Gr. 1 + 3 Gewindeschablone / Gauge Schraubendreher / Screwdriver	1	0080 15 20054





BD 435 leer



BD 980 leer

BD 435 Bestückungsvorschlag / Proposal of content

Durchmesser Size	Menge Quantity	Durchmesser Size	Menge Quantity
1,0 mm	20	7,5 mm	20
1,5 mm	20	8,0 mm	20
2,0 mm	20	8,5 mm	10
2,5 mm	20	9,0 mm	10
3,0 mm	40	9,5 mm	10
3,5 mm	20	10,0 mm	10
4,0 mm	20	10,5 mm	10
4,5 mm	20	11,0 mm	5
5,0 mm	40	11,5 mm	5
5,5 mm	20	12,0 mm	5
6,0 mm	40	12,5 mm	5
6,5 mm	20	13,0 mm	5
7,0 mm	20		

BD 980 Bestückungsvorschlag / Proposal of content

Durchmesser Size	Menge Quantity
1,0 – 2,9 x 0,1 mm	10
3,1 – 3,9 x 0,1 mm	10
4,1 – 4,9 x 0,1 mm	10
5,1 – 5,9 x 0,1 mm	10
6,1 – 10,0 x 0,1 mm	10
10,5 – 11,0 x 0,5 mm	10
3,0 mm	20
4,0 mm	20
5,0 mm	20
6,0 mm	20
11,5 – 13,0 x 0,5 mm	5

Ohne Bohrer / Without drills

Bezeichnung Description	Teile Pieces	Inhalt Content	Maße Dimension		Artikel-Nr. Part-No.
BD 435 leer	435	Ø 1,0 – 13,0 mm x 0,5 mm	375 x 235 x 205 mm	1	0130 15 00003
BD 980 leer	980	Ø 1,0 – 10,0 mm x 0,1 mm Ø 10,5 – 13,0 mm x 0,5 mm	380 x 460 x 220 mm	1	0130 15 00004

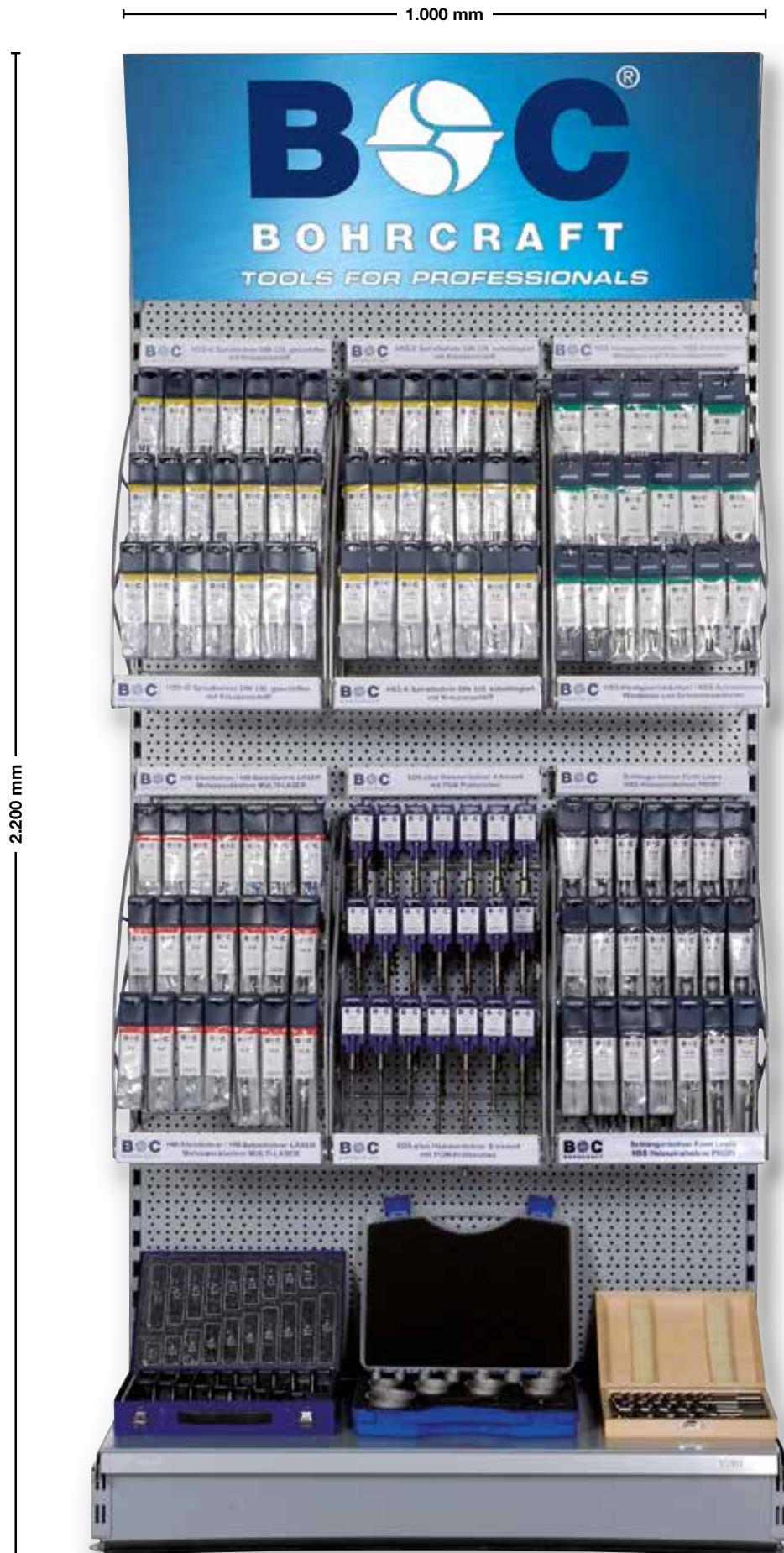

MODULE
DISPLAYS

Produktinformationen zu BOHRCRAFT System Modulen Product information for BOHRCRAFT display system

Unsere BOHRCRAFT System Module ermöglichen es Ihnen, ein auf Ihren Kundenkreis abgestimmtes Bohrercenter individuell nach Ihren Wünschen und der vorgesehenen Verkaufsfläche zusammenzustellen.

Eine klare Präsentation hochwertiger Präzisionswerkzeuge zum Bohren, Senken, Sägen und Schrauben garantiert eine hohe Umschlagshäufigkeit und steigert Ihre Fachkompetenz als Werkzeughändler.

Sie können hierbei entweder auf unsere bewährten Modul-Zusammenstellungen zurückgreifen oder Ihre eigenen Kombinationswünsche realisieren. Hierzu stellen wir Ihnen gerne unsere Erfahrungen zur Verfügung und beraten Sie kompetent und praxisbezogen.

Our BOHRCRAFT modular display system allows you to put together your own "Drill-Centre" tailored to your personal wishes in the allocated displayspace and to suit your particular customers.

A clear visual presentation of quality precision tools for drilling, countersinking, sawing and screwdriving ensures a rapid movement of stock and raises the professionalism of the dealer.

You may decide to stick with the well proven BOHRCRAFT module arrangements or if you prefer you can create your own variations. Either way, we will be happy to lend our experience to offer competent and practical advice.

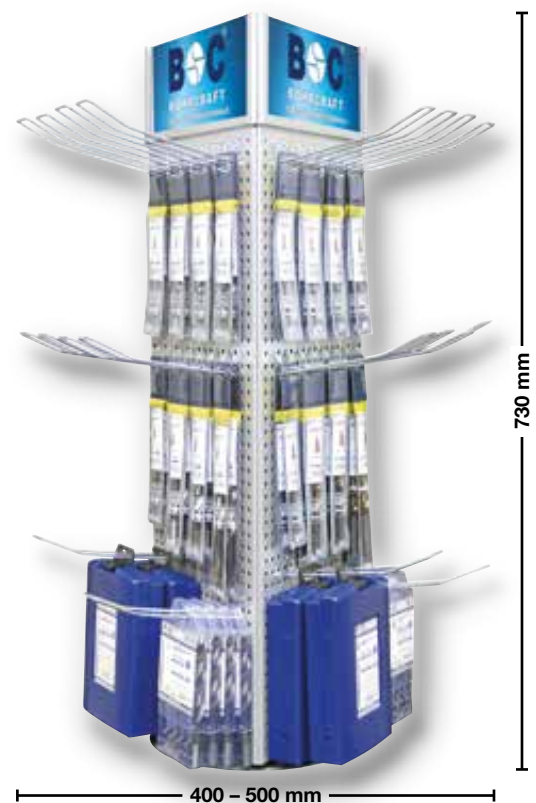

Bezeichnung Description		Artikel-Nr. Part-No.
Kugelschreiber BC-Blau / Ballpoint BC-blue	1	9990 00 00013



Bezeichnung Description		Artikel-Nr. Part-No.
Zimmermannsbleistift / Carpenter pencil	1	9990 00 00024



Bezeichnung Description		Artikel-Nr. Part-No.
Holz-Maßstab / Wood folding rule	1	9990 00 00022



Bezeichnung Description		Artikel-Nr. Part-No.
Notizblock DIN A6 / Notepad DIN A6	1	9990 00 00010

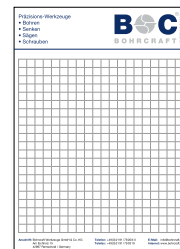

Bezeichnung Description		Artikel-Nr. Part-No.
Baumwolltasche / Cotton bag	1	9990 00 00015



WERBEMITTEL
ADVERTISING PRODUCTS

Bezeichnung Description		Artikel-Nr. Part-No.
Flaschenöffner 2K-Griff Bottle opener with 2K-handle	1	9990 00 00023





Bezeichnung Description		Artikel-Nr. Part-No.
Tasse / Cup	1	9990 00 00020



Bezeichnung Description		Artikel-Nr. Part-No.
Basecap	1	9990 00 00025

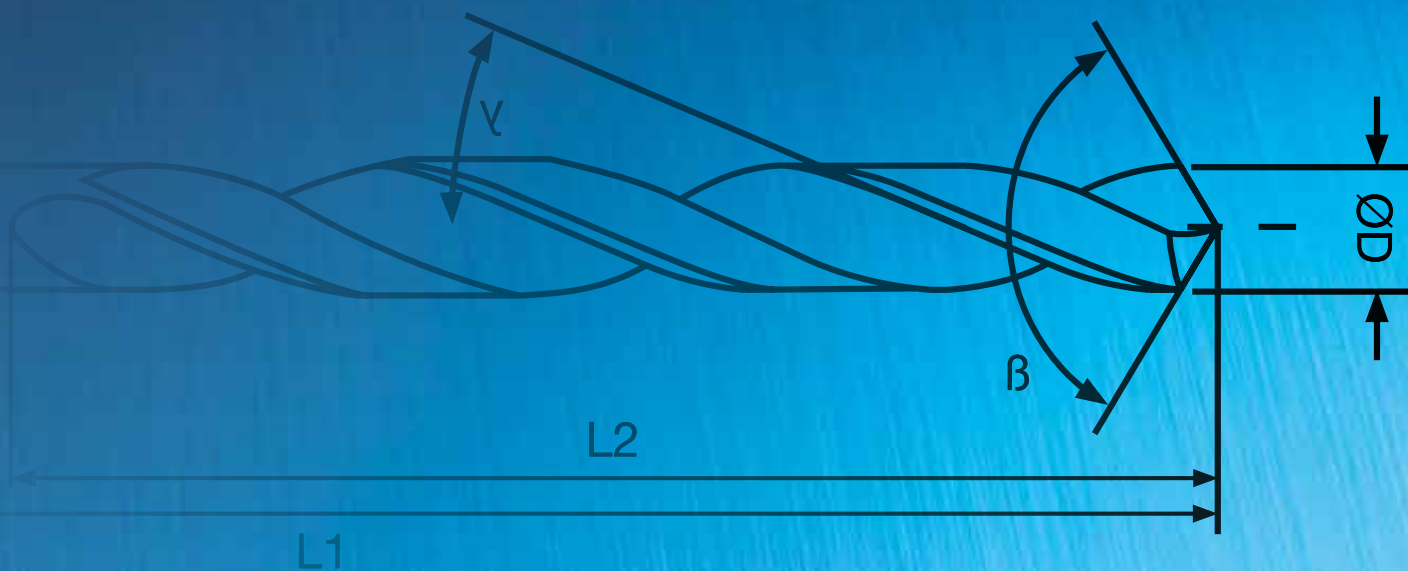



Bezeichnung Description	Seite Page
Technische Informationen / Technical information	
Werkstoffgruppen Material groups	444 – 445
Einsatzempfehlung für Spiralbohrer HSS und HSS-E Application recommendation for twist drills HSS and HSS-E	446 – 447
Einsatzempfehlung für Schafffräser HSS-E und VHM Application recommendation for end mills HSS-E and solid carbide	 www.bohrcraft.de
Härtevergleichstabelle Hardness comparison table	448
Umrechnungstabelle / Zoll Steigungen in mm Conversion table / Threads per inch in mm	449
Übersicht Unified-Gewinde (UNC, UNF, UNEF, UN) ANSI B 1.1 Overview Unified threads (UNC, UNF, UNEF, UN) ANSI B 1.1	450
Übersicht Britische Standard-Gewinde BSW, BSF, BSB-Brass, BSC, WHIT Overview British standard-threads BSW, BSF, BSB-brass, BSC, WHIT	451
Anwendungsübersicht Gewindereparatur Table of application thread repair	452 – 453
Anwendungsempfehlung für Kegelsenker, Stufen- und Blechschälbohrer Application recommendation for countersinks, step- and sheet metal drills	454 – 455
Anwendungsempfehlung für Hartmetall und HSS-Frässtifte Application recommendation for carbide and HSS-Rotary burrs	456 – 457
Lieferbare Beschichtungen Available coatings	457
Anwendungsempfehlung für Bi-Metall Lochsägen HSS / HSS-E (Co8) Application recommendation for Bi-Metal hole saws HSS / HSS-E (Co8)	458
Code Index Code index	459

			RM	Bezeichnung Description	Werkstoff-Nr. Material-No.
Stahlwerkstoffe		Steel materials			
1.1	Kaltfließpressstähle	Cold-extrusion steels	≤ 600 N/mm ²	Cq15	1.1132
	Baustähle	Construction steels		S235JR (St37-2)	1.0037
	Automatenstähle	Free-cutting steels		10SPb20	1.0722
2.1	Baustähle	Construction steels	≤ 800 N/mm ²	E360 (St 70 -2)	1.0070
	Einsatzstähle	Cementation steels		16MnCr5	1.7131
	Stahlguss	Steel casting, etc.		GS-25CrMo4	1.7218
P 3.1	Einsatzstähle	Cementation steels	≤ 1000 N/mm ²	20MoCr3	1.7320
	Vergütungsstähle	Heat-treatable steels		42CrMo4	1.7225
	Kaltarbeitsstähle, u. a.	Cold work steels		102Cr6	1.2067
4.1	Vergütungsstähle	Heat-treatable steels	≤ 1200 N/mm ²	50CrMo4	1.7228
	Kaltarbeitsstähle	Cold work steels		X45NiCrMo4	1.2767
	Nitrierstähle, u. a.	Nitriding steels, etc.		31CrMo12	1.8515
5.1	Hochlegierte Stähle	High-alloyed steels	≤ 1400 N/mm ²	X38CrMoV5-3	1.2367
	Kaltarbeitsstähle	Cold work steels		X100CrMoV8-1-1	1.2990
	Warmarbeitsstähle	Hot work steels		X40CrMoV5-1	1.2344
Nichtrostende Stahlwerkstoffe		Stainless steel materials			
1.1	Ferritisch, martensitisch	Ferritic, martensitic	≤ 950 N/mm ²	X2CrTi12	1.4512
2.1	Austenitisch	Austenitic	≤ 950 N/mm ²	X6CrNiMoTi17-12-2	1.4571
M 3.1	Austenitisch-ferritisch (Duplex)	Austenitic-ferritic (Duplex)	≤ 1100 N/mm ²	X2CrNiMoN22-5-3	1.4462
4.1	Austenitisch-ferritisch hitzebeständig (Super Duplex)	Austenitic-ferritic heat-resistant (Super Duplex)	≤ 1250 N/mm ²	X2CrNiMoN25-7-4	1.4410
Gusswerkstoffe		Cast materials			
1.1	Gusseisen mit Lamellengraphit (GJL)	Cast iron with lamellar graphite (GJL)	100-250 N/mm ²	EN-GJL-200 (GG20)	EN-JL-1030
			250-450 N/mm ²	EN-GJL-300 (GG30)	EN-JL-1050
2.1	Gusseisen mit Kugelgraphit (GJS)	Cast iron with nodular graphite (GJS)	350-500 N/mm ²	EN-GJS-400-15 (GGG40)	EN-JS-1030
			500-900 N/mm ²	EN-GJS-700-2 (GGG70)	EN-JS-1070
K 3.1	Gusseisen mit Vermiculargraphit (GJV)	Cast iron with vermicular graphite (GJV)	300-400 N/mm ²	GJV 300	-
			400-500 N/mm ²	GJV 450	-
4.1	Temperguss (GTMW, GTMB)	Malleable cast iron (GTMW, GTMB)	250-500 N/mm ²	EN-GJMW-350-4 (GTW-35)	EN-JM-1010
4.2			500-800 N/mm ²	EN-GJMB-450-6 (GTS-45)	EN-JM-1140
Nichteisenwerkstoffe		Non ferrous materials			
Aluminium-Legierungen		Aluminium alloys			
1.1			≤ 200 N/mm ²	EN AW-AIMn1	EN AW-3103
1.2	Aluminium-Knetlegierungen	Aluminium wrought alloys	≤ 350 N/mm ²	EN AW-AIMgSi	EN AW-6060
1.3			≤ 550 N/mm ²	EN AW-AIZn5Mg3Cu	EN AW-7022
1.4			Si ≤ 7%	EN AC-AIMg5	EN AC-51300
1.5	Aluminium-Gusslegierungen	Aluminium cast alloys	7% < Si ≤ 12%	EN AC-AISI9Cu3	EN AC-46500
1.6			12% < Si ≤ 17%	GD-AISI17Cu4FeMg	-
Kupfer-Legierungen		Copper alloys			
2.1	Reinkupfer, niedriglegiertes Kupfer	Pure copper, low-alloyed copper	≤ 400 N/mm ²	E-Cu 57	EN CW 004 A
N 2.2	Kupfer-Zink-Legierungen (Messing, langspanend)	Copper-zinc alloys (brass, long-chipping)	≤ 550 N/mm ²	CuZn37 (Ms63)	EN CW 508 L
2.3	Kupfer-Zink-Legierungen (Messing, kurzspanend)	Copper-zinc alloys (brass, short-chipping)	≤ 550 N/mm ²	CuZn36Pb3 (Ms58)	EN CW 603 N
2.4	Kupfer-Aluminium-Legierungen (Alubronze, langspanend)	Copper-aluminium alloys (alu bronze, long-chipping)	≤ 800 N/mm ²	CuAl10Ni5Fe4	EN CW 307 G
2.5	Kupfer-Zinn-Legierungen (Zinnbronze, langspanend)	Copper-tin alloys (tin bronze, long-chipping)	≤ 700 N/mm ²	CuSn8P	EN CW 307 G
2.6	Kupfer-Zinn-Legierungen (Zinnbronze, kurzspanend)	Copper-tin alloys (tin bronze, short-chipping)	≤ 400 N/mm ²	CuSn7 ZnPb (Rg7)	2.1090
2.7			≤ 600 N/mm ²	(AMPCO® 8)	-
2.8	Kupfer-Sonderlegierungen	Special copper alloys	≤ 1400 N/mm ²	(AMPCO® 45)	-

TECHNISCHE INFORMATIONEN
TECHNICAL INFORMATION

			RM	Bezeichnung Description	Werkstoff-Nr. Material-No.
	Magnesium-Legierungen	Magnesium alloys			
3.1	Magnesium-Knetlegierungen	Magnesium wrought alloys	≤ 500 N/mm ²	MgAl6Zn	3.5612
3.2	Magnesium-Gusslegierungen	Magnesium cast alloys	≤ 500 N/mm ²	EN-MCMgAl9Zn1	EN-MC21120
	Kunststoffe	Synthetics			
N	4.1 Duroplaste (kurzspanend)	Duroplastics (short-chipping)	-	Bakelit, Pertinax	-
	4.2 Thermoplaste (langspanend)	Thermoplastics (long-chipping)	-	PMMA, POM, PVC	-
	4.3 Faserverstärkte Kunststoffe (Faseranteil ≤ 30%)	Fibre-reinforced synthetics (fibre content ≤ 30%)	-	GFK, CFK, AFK	-
	4.4 Faserverstärkte Kunststoffe (Faseranteil > 30%)	Fibre-reinforced synthetics (fibre content > 30%)	-	GFK, CFK, AFK	-
	Besondere Werkstoffe	Special materials			
5.1	Grafit	Graphite	-	C 8000	-
5.2	Wolfram-Kupfer-Legierungen	Tungsten-copper alloys	-	W-Cu 80/20	-
5.3	Verbundwerkstoffe	Composite materials	-	Hylite, Alucobond	-
	Spezialwerkstoffe	Special materials			
	Titan-Legierungen	Titanium alloys			
S	1.1 Reintitan	Pure titanium	≤ 450 N/mm ²	Ti1	3.7025
	1.2 Titan-Legierungen	Titanium alloys	≤ 900 N/mm ²	TiAl6V4	3.7165
	1.3 Titan-Legierungen	Titanium alloys	≤ 1250 N/mm ²	TiAl4Mo4Sn2	3.7185
	Nickel-, Kobalt- und Eisen-Legierungen	Nickel alloys, cobalt alloys and iron alloys			
S	2.1 Reinnickel	Pure nickel	≤ 600 N/mm ²	Ni 99,6	2.4060
	2.2 Nickel-Basis-Legierungen	Nickel-base alloys	≤ 1000 N/mm ²	Monel 400	2.4360
	2.3 Nickel-Basis-Legierungen	Nickel-base alloys	≤ 1600 N/mm ²	Inconel 718	2.4668
	2.4 Kobalt-Basis-Legierungen	Cobalt-base alloys	≤ 1000 N/mm ²	Udimet 605	-
	2.5 Kobalt-Basis-Legierungen	Cobalt-base alloys	≤ 1600 N/mm ²	Haynes 25	2.4964
	2.6 Eisen-Basis-Legierungen	Iron-base alloys	≤ 1500 N/mm ²	Incoloy 800	1.4958
	Harte Werkstoffe	Hard materials			
H	1.1		44 – 50 HRC	Weldox 1100	-
	1.2		50 – 55 HRC	Hardox 550	-
	1.3	Hochfeste Stähle, gehärtete Stähle, Hartguss	High strength steels, hardened steels, hard castings	Armox 600T	-
	1.4		60 – 63 HRC	Ferro-Titanit	-
	1.5		63 – 66 HRC	HSSE	-



Schnittgeschwindigkeiten · Vorschübe · Spitzenwinkel
Cutting speeds · Feed motion · Point angles

	Typ Type	Qualität Quality	Spitzen- winkel Point angles	Kühlmittel Lubrication	Vc m/min	Mittlere Drehzahlen (U/min) Average rotation speed (RPM)										
						Ø 2	Ø 5	Ø 8	Ø 12	Ø 16	Ø 25	Ø 40	Ø 63	Ø 80		
Stahlwerkstoffe / Steel material																
P	1.1	Automatenstahl bis Free cutting steels up to 500 N/mm ²	N	HSS	118°	Emulsion	30 – 50	5600 0,05	2250 0,12	1400 0,20	930 0,25	700 0,30	450 0,40	280 0,40	180 0,50	160 0,50
		Unleg. Baustahl bis Unalloyed structural steel up to 500 N/mm ²	N	HSS	118°	Emulsion	30 – 40	5600 0,05	2250 0,12	1400 0,20	930 0,25	700 0,30	450 0,40	280 0,40	180 0,50	140 0,60
	2.1	Unleg. Baustahl bis Unalloyed structural steel 500 – 700 N/mm ²	N	HSS	118°	Emulsion	25 – 35	4750 0,05	1900 0,12	1200 0,20	800 0,25	600 0,30	400 0,35	240 0,40	150 0,50	120 0,60
	2.1	Unleg. Baustahl bis Unalloyed structural steel up to 700 – 900 N/mm ²	N	HSS	118°	Emulsion	10 – 15	2100 0,03	860 0,07	540 0,10	360 0,16	270 0,20	170 0,25	110 0,32	68 0,40	50 0,50
	2.1	Unleg. Stahlguss bis Unalloyed cast steel up to 700 N/mm ²	N	HSS	118°	Emulsion	20 – 30	3980 0,03	1580 0,07	995 0,10	665 0,16	495 0,20	320 0,25	200 0,32	125 0,40	100 0,5
	3.1	Leg. Stahlguss Alloyed cast steel	N	HSS	118°	Emulsion (Öl / Oil)	10 – 20	2380 0,02	950 0,05	595 0,08	400 0,12	300 0,14	190 0,18	120 0,23	75 0,27	60 0,2
	3.1	Leg. Stahl Alloyed steel 700 – 900 N/mm ²	N	HSS	118°	Emulsion	10 – 15	2100 0,02	860 0,05	540 0,08	360 0,12	270 0,14	170 0,18	110 0,23	68 0,27	50 0,32
	4.1	Leg. Cr-Ni-Stahl Alloyed Cr-Ni steel 900 – 1100 N/mm ²	N Ti	HSS HSS-E	118° 130°	Emulsion (Öl / Oil)	8 – 12	1590 0,02	635 0,05	400 0,08	265 0,12	200 0,14	125 0,18	80 0,23	50 0,27	40 0,32
	4.1	Federstahl, unvergütet Spring steel, untempered	N MN	HSS-E	130°	Emulsion (Öl / Oil)	5 – 10	1590 0,02	635 0,05	400 0,08	265 0,12	200 0,14	125 0,18	80 0,23	50 0,27	40 0,32
	5.1	Leg. Cr-Ni-Mo-Stahl Alloyed Cr-Ni-Mo steel 1100 – 1400 N/mm ²	N	HSS-E	130°	Emulsion (Öl / Oil)	6 – 10	1275 0,02	505 0,05	320 0,08	210 0,12	160 0,14	100 0,18	65 0,23	40 0,27	32 0,32
	5.1	Mangan-Hartstahl Austenitic manganese steel > 10% Mn	N MN	HSS-E Co8	130°	Trocken erwärm. Dry heated 200° – 300°	3 – 5	635 0,02	255 0,05	160 0,08	105 0,12	80 0,14	50 0,18	30 0,23	20 0,27	16 0,32
	Nichtrostende Stahlwerkstoffe / Stainless steel materials															
M	1.1	Rost- und säurebest. Stahl Stainless steel	N	HSS-E	130°	Emulsion (Öl / Oil)	6 – 10	1275 0,02	505 0,05	320 0,08	210 0,12	160 0,14	100 0,18	65 0,23	40 0,27	32 0,32
	3.1															
	4.1	Hitzebest. Stahl Heat-resistant steel	N	HSS-E	130°	Emulsion (Öl / Oil)	6 – 10	1275 0,02	505 0,05	320 0,08	210 0,12	160 0,14	100 0,18	65 0,23	40 0,27	32 0,32
Gusswerkstoffe / Cast materials																
K	1.1	Grauguss bis Grey cast iron up to 200 HB	N	HSS	118°	Trocken Pr.-Luft Dry com- pressed air	15 – 25	3185 0,05	1265 0,12	795 0,20	530 0,25	400 0,30	255 0,40	160 0,40	100 0,50	80 0,60
	1.2	Grauguss 350 HB (Hartguss) Grey cast iron Iron 350 HB (chilled casting)	N	HSS HSS-E	118° 130°	Trocken Pr.-Luft Dry com- pressed air	5 – 15	1590 003	635 0,07	400 0,10	265 0,16	200 0,20	165 0,25	80 0,32	50 0,40	40 0,50
Nichteisenwerkstoffe / Non ferrous materials																
N	1.1	Aluminium	W	HSS	130°	Emulsion	40–100	11140 0,05	4435 0,14	2785 0,18	1855 0,22	1395 0,30	890 0,40	555 0,45	350 0,50	280 0,60
	1.2	Alu-Leg. Langspanend Aluminium alloys, long chipping	W	HSS	130°	Emulsion	30 – 65	7600 0,05	3030 0,14	1900 0,18	1260 0,22	950 0,30	600 0,40	380 0,45	240 0,50	190 0,60
	1.3															
	1.4	Alu-Leg. Kurzspanend Aluminium alloys, short chipping	N (W)	HSS	118° (130°)	Emulsion	30 – 60	7200 0,05	2900 0,14	1800 0,18	1200 0,22	900 0,30	580 0,40	360 0,45	230 0,50	180 0,60
	1.5															
	1.6	Alu-Si-Leg., Silumin Al-Si alloy, silumin	W (N)	HSS	130° (118°)	Emulsion	30 – 50	6365 0,05	2535 0,08	1590 0,14	1060 0,20	795 0,25	510 0,30	320 0,40	200 0,50	160 0,60
2.1	Hüttenkupfer Refined copper	W (N)	HSS	130° (118°)	Emulsion (Öl / Oil)	35 – 65	7960 0,05	3170 0,14	1990 0,18	1325 0,22	995 0,30	635 0,40	400 0,45	250 0,50	200 0,60	

TECHNISCHE INFORMATIONEN
TECHNICAL INFORMATION

Einsatzempfehlung für Spiralbohrer aus HSS und HSS-E

Application recommendation for twist drills HSS and HSS-E

Schnittgeschwindigkeiten · Vorschübe · Spitzenwinkel
Cutting speeds · Feed motion · Point angles

	Typ Type	Qualität Quality	Spitzen- winkel Point angles	Kühlmittel Lubrication	Vc m/min	Mittlere Drehzahlen (U/min) Average rotation speed (RPM)											
						Ø 2	Ø 5	Ø 8	Ø 12	Ø 16	Ø 25	Ø 40	Ø 63	Ø 80			
Nichteisenwerkstoffe / Non ferrous materials																	
N	2.1	Elektrolyt-Kupfer Electrolytic copper	N	HSS	118°	Emulsion (Öl / Oil)	20 – 35	4400 0,05	1750 0,14	1100 0,18	730 0,22	550 0,30	350 0,40	220 0,45	140 0,50	110 0,60	
	2.2 – 2.3	Zink, Zink-Leg. Zinc, zinc alloys	N (W)	HSS	118° (130°)	Emulsion	35 – 50	6800 0,05	2700 0,14	1700 0,18	1130 0,20	850 0,25	540 0,30	340 0,40	215 0,50	170 0,60	
	2.2	Messing, zäh Brass tough Ms 60, Ms 63	H (N)	HSS	118° (118°)	Emulsion (Öl / Oil)	35 – 60	7560 0,05	3020 0,15	2000 0,20	1260 0,25	950 0,35	600 0,40	380 0,5	240 0,60	200 0,70	
	2.3	Messing, spröde Brass brittle Ms 58	H	HSS	118°	Trocken / Dry Öl / Oil Emulsion	60 – 100	12740 0,08	5100 0,18	3200 0,25	2100 0,30	1600 0,35	1020 0,40	640 0,50	400 0,60	320 0,70	
	2.4	Alu-Bronze (halbhart, hart) Aluminium bronze (semihard, hard)	N	HSS	118°	Emulsion (Öl / Oil)	15 – 35	3980 0,05	1585 0,08	995 0,14	665 0,20	495 0,25	320 0,30	200 0,40	125 0,50	100 0,60	
	2.6	Rotguss, Bronze (weich) Red brass, bronze (soft)	N	HSS	118°	Emulsion (Öl / Oil)	20 – 40	4745 0,05	1900 0,08	1195 0,14	795 0,20	595 0,25	380 0,30	240 0,40	150 0,50	120 0,60	
	2.6	Neusilber Nickel silver	N	HSS	118°	Emulsion (Öl / Oil)	25 – 50	6000 0,05	2400 0,08	1500 0,14	995 0,20	750 0,25	480 0,30	300 0,40	190 0,50	150 0,60	
	3.1 – 3.2	Magnesium-Leg., Elektron Magnesium alloy, electron	H	HSS	118°	Trocken kein Wasser Dry without water	60 – 100	12740 0,08	5100 0,18	3200 0,25	2100 0,30	1600 0,35	1020 0,40	640 0,50	400 0,60	320 0,70	
	4.1	Kunststoffe hart (Duroplaste) Plastics hard (thermoset)	HK	HSS	80°	Trocken Pr.-Luft Dry com- pressed air	10 – 20	2380 0,05	950 0,14	595 0,18	400 0,20	300 0,25	190 0,30	120 0,40	75 0,50	60 0,60	
	4.1	Schichtpressstoffe, Papier, Gewebe, Holz Laminate, paper, fabric, wood	W H	HSS	130° 80°	Trocken Pr.-Luft Dry com- pressed air	15 – 25	3185 0,05	1265 0,14	795 0,18	530 0,20	400 0,25	255 0,30	160 0,40	100 0,50	80 0,60	
	4.2	Kunststoffe weich (Thermoplaste) Plastics soft (thermoplastics)	W	HSS	130°	Wasser Pr.-Luft Water com- pressed air	20 – 40	4745 0,05	1900 0,14	1195 0,18	795 0,20	595 0,25	380 0,30	240 0,40	150 0,50	120 0,60	
	4.2	Plexiglas Acrylic glass	HK	HSS	80°	Wasser Water	15 – 25	3185 0,05	1265 0,14	795 0,18	530 0,20	400 0,25	255 0,30	160 0,40	100 0,50	80 0,60	
	5.1	Graphit Graphite	HK	HSS	80°	Trocken Pr.-Luft Dry com- pressed air	3 – 6	Hand	Hand	Hand	Hand	Hand	Hand	Hand	Hand	Hand	Hand
	Spezialwerkstoffe / Special materials																
S	1.1 – 1.2	Titan und Titanlegierungen Titanium & titanium alloys	N	HSS-E	130°	Öl Oil	3 – 6	715 0,02	285 0,05	180 0,08	120 0,12	90 0,14	60 0,18	35 0,23	20 0,27	16 0,32	
	2.1 – 2.2	Nickel Monel	N	HSS HSS-E	118° 130°	Emulsion (Öl / Oil)	10 – 15	2100 0,02	860 0,05	540 0,08	360 0,12	270 0,14	170 0,18	110 0,23	68 0,27	50 0,32	
	2.2 – 2.2	Nimonic, Hastelloy Inconel	N	HSS-E	130°	Öl Oil	3 – 8	875 0,02	350 0,05	220 0,08	145 0,12	110 0,14	70 0,18	44 0,23	25 0,27	20 0,32	
	Harte Werkstoffe / Hard materials																
	H	1.2	Hardox HiTuf	HDX	HSS-E Co8	130°	Öl / Oil	~ 11	1400 0,035	700 0,06	440 0,09	270 0,14	-	-	-	-	-
Hardox 400 / XAR 400			HDX	HSS-E Co8	130°	Öl / Oil	~ 8	1000 0,025	510 0,05	320 0,08	200 0,13	-	-	-	-	-	
Hardox 450 / XAR 450			HDX	HSS-E Co8	130°	Öl / Oil	~ 6	770 0,015	400 0,04	240 0,07	150 0,12	-	-	-	-	-	
Hardox 500 / XAR 500			HDX	HSS-E Co8	130°	Öl / Oil	~ 4	500 0,005	255 0,03	160 0,06	100 0,1	-	-	-	-	-	
1.4		Ferro-Titanit (Ferro-Tic)	V	HSS-E	130°	Trocken Pr.-Luft Dry com- pressed air	3 – 6	715 0,02	285 0,05	180 0,08	120 0,12	90 0,14	60 0,18	35 0,23	20 0,27	16 0,32	



Härtevergleichstabelle

Hardness comparison table

N/mm ²	HRC	Rockwell HRA	HRB	HRF	Vickers HV (≥ 98N)	Brinell HB 30
255	-	-	-	-	80	76
285	-	-	48	83	90	86
320	-	-	56	87	100	95
350	-	-	62	91	110	105
385	-	-	67	94	120	114
415	-	-	71	96	130	124
450	-	-	75	99	140	133
480	-	-	79	101	150	143
510	-	-	82	104	160	152
545	-	-	85	106	170	162
575	-	-	87	107	180	171
610	-	-	90	109	190	181
640	-	-	92	110	200	190
675	-	-	94	111	210	199
705	-	-	95	112	220	209
740	-	-	97	113	230	219
770	20	61	98	114	240	228
800	22	62	100	115	250	238
835	24	62	101	-	260	247
865	26	63	102	-	270	257
900	27	64	104	-	280	266
930	29	65	105	-	290	276
965	30	65	-	-	300	285
1030	32	66	-	-	320	304
1095	34	68	-	-	340	323
1155	37	69	-	-	360	342
1220	39	70	-	-	380	361
1290	41	71	-	-	400	380
1350	43	72	-	-	420	399
1420	45	73	-	-	440	418
1485	46	74	-	-	460	437
1555	48	75	-	-	480	456
1595	48	75	-	-	490	466
1665	50	76	-	-	510	485
1740	51	76	-	-	530	504
1810	52	77	-	-	550	523
1880	54	78	-	-	570	542
1955	55	78	-	-	590	561
2030	56	79	-	-	610	580
2105	57	80	-	-	630	599
2180	58	80	-	-	650	618
-	59	81	-	-	670	636
-	60	81	-	-	690	-
-	61	82	-	-	720	-
-	63	83	-	-	760	-
-	64	84	-	-	800	-
-	65	84	-	-	840	-
-	66	85	-	-	880	-



Umrechnungstabelle / Zoll Steigungen in mm Conversion table / Threads per inch in mm

P (Gg / 1)	mm
100	0,254000
96	0,264583
80	0,317500
72	0,352778
64	0,396875
60	0,423333
56	0,453571
48	0,529167
44	0,577273
40	0,635000
36	0,705556
32	0,793750

P (Gg / 1)	mm
28	0,907143
27	0,940741
26	0,976923
25	1,016000
24	1,058333
22	1,154545
20	1,270000
19	1,336842
19	1,336842
18	1,411111
16	1,587500
14	1,814286

P (Gg / 1)	mm
13	1,953846
12	2,116667
11,5	2,208696
11	2,309091
10	2,540000
9	2,822222
8	3,175000
7	3,628571
6	4,233333
5	5,080000
4.1/2	5,644444
4	6,350000

P (Gg / 1)	mm
3.1/2	7,257143
3.1/4	7,815385
3	8,466667
2.7/8	8,834783
2.3/4	9,236364
2.5/8	9,676190
2.1/2	10,160000
2.1/4	11,288889
2	12,700000

Zoll / Inch	mm
1/32	0,794
1/16	1,588
1/8	3,175
3/16	4,763
1/4	6,350
5/16	7,938
3/8	9,525
7/16	11,113
1/2	12,700
9/16	14,288
5/8	15,875
11/16	17,463
3/4	19,050
13/16	20,638
7/8	22,225
15/16	23,813
1	25,400
1.1/16	26,988
1.1/8	28,575
1.3/16	30,163
1.1/4	31,750
1.5/16	33,338
1.3/8	34,925
1.7/16	36,513
1.1/2	38,100
1.9/16	39,688
1.5/8	41,275
1.11/16	42,863
1.3/4	44,450
1.13/16	46,038
1.7/8	47,625
1.15/16	49,213
2	50,800
2.1/16	52,388
2.1/8	53,975
2.3/16	55,563
2.1/4	57,150

Zoll / Inch	mm
2.5/16	58,738
2.3/8	60,325
2.7/16	61,913
2.1/2	63,500
2.9/16	65,088
2.5/8	66,675
2.11/16	68,263
2.3/4	68,850
2.13/16	71,438
2.7/8	73,025
2.15/16	74,613
3	76,200
3.1/16	77,788
3.1/8	79,375
3.3/16	80,963
3.1/4	82,550
3.5/16	84,138
3.3/8	85,725
3.7/16	87,313
3.1/2	88,900
3.9/16	90,488
3.5/8	92,075
3.11/16	93,663
3.3/4	95,250
3.13/16	96,838
3.7/8	98,425
3.15/16	100,130
4	101,600
4.1/16	103,188
4.1/8	104,775
4.3/16	106,363
4.1/4	107,950
4.5/16	109,538
4.3/8	111,125
4.7/16	112,713
4.1/2	114,300
4.9/16	115,888

Zoll / Inch	mm
4.5/8	117,475
4.11/16	119,063
4.3/4	120,650
4.13/16	122,238
4.7/8	123,825
4.15/16	125,413
5	127,000
5.1/16	128,588
5.1/8	130,175
5.3/16	131,763
5.1/4	133,350
5.5/16	134,938
5.3/8	136,525
5.7/16	138,113
5.1/2	139,700
5.9/16	141,288
5.5/8	142,875
5.11/16	144,463
5.3/4	146,050
5.13/16	147,638
5.7/8	149,225
5.15/16	150,813

G/BSP Zoll / Inch	mm
G 1/8	9,728
G 1/4	13,157
G 3/8	16,662
G 1/2	20,955
G 5/8	22,911
G 3/4	26,441
G 7/8	30,201
G 1	33,249
G 1.1/8	37,897
G 1.1/4	41,910
G 1.3/8	44,323
G 1.1/2	47,803
G 1.3/4	53,746
G 2	59,614
G 2.1/4	65,710
G 2.1/2	75,184
G 2.3/4	81,534
G 3	87,884
G 3.1/4	93,980
G 3.1/2	100,330
G 3.3/4	106,680
G 4	113,030

Nummer Number	mm
0	1,520
1	1,850
2	2,180
3	2,520
4	2,850
5	3,180
6	3,510
8	4,170
10	4,830
12	5,490



Übersicht Unified-Gewinde (UNC, UNF, UNEF, UN) ANSI B 1.1

Overview Unified threads (UNC, UNF, UNEF, UN) ANSI B 1.1

Gewinde- / Thread			Gewindesteigung, Anzahl der Gewindegänge pro Zoll (Inch) Pitch, threads per inch (TPI)										
Abmessung Size	Nenn-Ø / Nominal-Ø		UNC	UNF	UNEF	Serien mit konstanter Steigung / Constant pitch series							
	Zoll (Inch)	mm				4-UN	6-UN	8-UN	12-UN	16-UN	20-UN	28-UN	32-UN
Nr. 0	0,0600	1,524	-	-	-	-	-	-	-	-	-	-	-
Nr. 1	0,0730	1,854	64	72	-	-	-	-	-	-	-	-	-
Nr. 2	0,0860	2,184	56	64	-	-	-	-	-	-	-	-	-
Nr. 3	0,0990	2,515	48	56	-	-	-	-	-	-	-	-	-
Nr. 4	0,1120	2,845	40	48	-	-	-	-	-	-	-	-	-
Nr. 5	0,1250	3,175	40	44	-	-	-	-	-	-	-	-	-
Nr. 6	0,1380	3,505	32	40	-	-	-	-	-	-	-	-	UNC
Nr. 8	0,1640	4,166	32	36	-	-	-	-	-	-	-	-	UNC
Nr. 10	0,1900	4,828	24	32	-	-	-	-	-	-	-	-	UNF
Nr. 12	0,2160	5,486	24	28	32	-	-	-	-	-	-	UNF	UNEF
1/4	0,2500	6,350	20	28	32	-	-	-	-	-	UNC	UNF	UNEF
5/16	0,3125	7,938	18	24	32	-	-	-	-	-	20	28	UNEF
3/8	0,7500	9,525	16	24	32	-	-	-	-	UNC	20	28	UNEF
7/16	0,4350	11,112	14	20	28	-	-	-	-	16	UNF	UNEF	32
1/2	0,5000	12,700	13	20	28	-	-	-	-	16	UNF	UNEF	32
9/16	0,5625	14,288	12	18	24	-	-	-	UNC	16	20	28	32
5/8	0,6250	15,875	11	18	24	-	-	-	12	16	20	28	32
11/16	0,6875	17,463	-	-	24	-	-	-	12	16	20	28	32
3/4	0,7500	19,050	10	16	20	-	-	-	12	UNF	UNEF	28	32
13/16	0,8125	20,638	-	-	20	-	-	-	12	16	UNEF	28	32
7/8	0,8750	22,225	9	14	20	-	-	-	12	16	UNEF	28	32
15/16	0,9375	23,813	-	-	20	-	-	-	12	16	UNEF	28	32
1	1,0000	25,400	8	12	20	-	-	UNC	UNF	16	UNEF	28	32
1.1/16	1,0625	26,988	-	-	18	-	-	8	12	16	20	28	-
1.1/8	1,1250	28,575	7	12	18	-	-	8	UNF	16	20	28	-
1.3/16	1,1870	30,162	-	-	18	-	-	8	12	16	20	28	-
1.1/4	1,2500	31,750	7	12	18	-	-	8	UNF	16	20	28	-
1.5/16	1,3125	33,338	-	-	18	-	-	8	12	16	20	28	-
1.3/8	1,3750	34,925	6	12	18	-	UNC	8	UNF	16	20	28	-
1.7/16	1,4375	36,512	-	-	18	-	6	8	12	16	20	28	-
1.1/2	1,5000	38,100	6	12	18	-	UNC	8	UNF	16	20	28	-
1.9/16	1,5620	39,688	-	-	18	-	6	8	12	16	20	-	-
1.5/8	1,6250	41,275	-	-	18	-	6	8	12	16	20	-	-
1.11/16	1,6875	42,862	-	-	18	-	6	8	12	16	20	-	-
1.3/4	1,7500	44,450	5	-	-	-	6	8	12	16	20	-	-
1.13/16	1,8125	46,038	-	-	-	-	6	8	12	16	20	-	-
1.7/8	1,8750	47,625	-	-	-	-	6	8	12	16	20	-	-
1.15/16	1,9375	49,212	-	-	-	-	6	8	12	16	20	-	-
2	2,0000	50,800	4.1/2	-	-	-	6	8	12	16	20	-	-
2.1/8	2,1250	53,975	-	-	-	-	6	8	12	16	20	-	-
2.1/4	2,2500	57,150	4.1/2	-	-	-	6	8	12	16	20	-	-
2.3/8	2,3750	60,325	-	-	-	-	6	8	12	16	20	-	-
2.1/2	2,5000	63,500	4	-	-	UNC	6	8	12	16	20	-	-
2.5/8	2,6250	66,675	-	-	-	4	6	8	12	16	20	-	-
2.3/4	2,7500	69,850	4	-	-	UNC	6	8	12	16	20	-	-
2.7/8	2,8750	73,025	-	-	-	4	6	8	12	16	20	-	-
3	3,0000	76,200	4	-	-	UNC	6	8	12	16	20	-	-
3.1/8	3,1250	79,375	-	-	-	4	6	8	12	16	-	-	-
3.1/4	3,2500	82,550	4	-	-	UNC	6	8	12	16	-	-	-
3.3/8	3,3750	85,725	-	-	-	4	6	8	12	16	-	-	-
3.1/2	3,5000	88,900	4	-	-	UNC	6	8	12	16	-	-	-
3.5/8	3,6250	92,075	-	-	-	4	6	8	12	16	-	-	-
3.3/4	3,7500	95,250	4	-	-	UNC	6	8	12	16	-	-	-
3.7/8	3,8750	98,425	-	-	-	4	6	8	12	16	-	-	-
4	4,0000	101,600	4	-	-	UNC	6	8	12	16	-	-	-



TECHNISCHE INFORMATIONEN
TECHNICAL INFORMATION

Übersicht Britische Standard-Gewinde BSW, BSF, BSB-Brass, BSC, WHIT

Overview British standard-threads BSW, BSF, BSB-brass, BSC, WHIT

Flankenwinkel 55° / Flank angle 55° Zuordnung von Nennmaß (Außendurchmesser) und Steigung / Allocation of nominal size (outer diameter) and pitch										
Gewinde- / Thread			Gewindesteigung, Anzahl der Gewindegänge pro Zoll (Inch) Pitch, threads per inch (TPI)							
Abmessung Size	Nenn-Ø / Nominal-Ø		BSW	BSF	BSC	Serien mit konstanter Steigung / Constant pitch series				
	Zoll (Inch)	mm				BRASS BSB	12-WHIT	16-WHIT	20-WHIT	32-WHIT
1/16	0,06250	1,5875	60	-	-	-	-	-	-	-
3/32	0,09375	2,3810	48	-	-	-	-	-	-	-
1/8	0,12500	3,1750	40	-	-	-	-	-	-	-
5/32	0,15625	3,9690	32	-	-	-	-	-	-	-
3/16	0,18750	4,7630	24	32	-	-	-	-	-	-
7/32	0,21875	5,5560	24	28	-	-	-	-	-	-
1/4	0,25000	6,3500	20	26	26	-	-	-	-	32
9/32	0,28125	7,1440	20	26	-	-	-	-	-	32
5/16	0,31250	7,9380	18	22	26	26	-	-	-	32
3/8	0,37500	9,5250	16	20	26	26	-	-	-	32
7/16	0,43750	11,1120	14	18	26	26	-	-	-	-
1/2	0,50000	12,7000	12	16	(18)	26	-	-	20	-
9/16	0,56250	14,2880	12	16	20	26	-	-	20	-
5/8	0,62500	15,8750	11	14	(18)	26	-	-	20	-
11/16	0,68750	17,4630	11	14	26	26	-	16	20	-
3/4	0,75000	19,0500	10	12	(16)	26	-	16	20	-
13/16	0,81250	20,6380	10	12	-	26	-	16	20	-
7/8	0,87500	22,2250	9	11	-	26	-	16	20	-
15/16	0,93750	23,8130	9	11	-	-	12	-	20	-
1	1,00000	25,4000	8	10	24 (16)	26	12	16	20	-
1.1/16	1,06250	26,9880	-	-	-	-	12	-	20	-
1.1/8	1,12500	28,5750	7	9	-	26	12	16	20	-
1.3/16	1,18750	30,1620	-	-	-	-	12	-	20	-
1.1/4	1,25000	31,7500	7	9	-	26	12	16	20	-
1.5/16	1,31250	33,3380	-	-	-	-	12	-	20	-
1.3/8	1,37500	34,9250	6	8	-	26	12	16	20	-
1.7/16	1,43750	36,5120	-	-	-	-	12	-	20	-
1.1/2	1,50000	38,1000	6	8	14	26	12	16	20	-
1.9/16	1,56200	39,6880	-	-	-	-	-	-	-	-
1.5/8	1,62500	41,2750	5	8	-	26	12	16	20	-
1.11/16	1,68700	42,8620	-	-	-	-	-	-	-	-
1.3/4	1,75000	44,4500	5	7	-	26	12	16	20	-
1.13/16	1,81250	46,0380	-	-	-	-	-	-	-	-
1.7/8	1,87500	47,6250	4.1/2	-	-	26	12	16	20	-
1.15/16	1,93750	49,2120	-	-	-	-	-	-	-	-
2	2,93750	50,8000	4.1/2	7	14	26	12	16	20	-
2.1/8	2,12500	53,9750	-	-	-	-	-	-	-	-
2.1/4	2,25000	57,1500	4	6	-	-	-	-	-	-
2.3/8	2,37500	60,3250	-	-	-	-	-	-	-	-
2.1/2	2,50000	63,5000	4	6	-	-	-	-	-	-
2.5/8	2,62500	66,6750	-	-	-	-	-	-	-	-
2.3/4	2,75000	69,8500	3.1/2	6	-	-	-	-	-	-
2.7/8	2,87500	73,0250	-	-	-	-	-	-	-	-
3	3,00000	76,2000	3.1/2	6	-	-	-	-	-	-



M MF	Ø mm	Min. Bohrtiefe Kernloch Min. drilling depth core hole					Gewindetiefe (inkl. Anschnitt) Tapping length (incl. chamfer)					Länge des Gewindeeinsatzes (eingebauter Zustand) Length of thread insert (installed condition)				
		1,0 x D mm	1,5 x D mm	2,0 x D mm	2,5 x D mm	3,0 x D mm	1,0 x D mm	1,5 x D mm	2,0 x D mm	2,5 x D mm	3,0 x D mm	1,0 x D mm	1,5 x D mm	2,0 x D mm	2,5 x D mm	3,0 x D mm
M 2 x 0,4	2,10	3,80	4,80	5,80	6,80	7,80	3,40	4,40	5,40	6,40	7,40	2,00	3,00	4,00	5,00	6,00
M 2,5 x 0,45	2,60	4,52	5,77	7,02	8,27	9,52	4,07	5,32	6,57	7,82	9,07	2,50	3,75	5,00	6,25	7,50
M 3 x 0,5	3,20	5,25	6,75	8,25	9,75	11,25	4,75	6,25	7,75	9,25	10,75	3,00	4,50	6,00	7,50	9,00
M 3,5 x 0,6	3,70	6,20	7,95	9,70	11,45	13,20	5,60	7,35	9,10	10,85	12,60	3,50	5,25	7,00	8,75	10,50
M 4 x 0,7	4,20	7,15	9,15	11,15	13,15	15,15	6,45	8,45	10,45	12,45	14,45	4,00	6,00	8,00	10,00	12,00
M 5 x 0,8	5,20	8,60	11,10	13,60	16,10	18,60	7,80	10,30	12,80	15,30	17,80	5,00	7,50	10,00	12,50	15,00
M 6 x 1	6,30	10,50	13,50	16,50	19,50	22,50	9,50	12,50	15,50	18,50	21,50	6,00	9,00	12,00	15,00	18,00
M 7 x 1	7,30	11,50	15,00	18,50	22,00	25,50	10,50	14,00	17,50	21,00	24,50	7,00	10,50	14,00	17,50	21,00
M 8 x 1	8,30	12,50	16,50	20,50	24,50	28,50	11,50	15,50	19,50	23,50	27,50	8,00	12,00	16,00	20,00	24,00
M 8 x 1,25	8,30	13,62	17,62	21,62	25,62	29,62	12,37	16,37	20,37	24,37	28,37	8,00	12,00	16,00	20,00	24,00
M 9 x 1,25	9,30	14,62	19,12	23,62	28,13	32,62	13,37	17,87	22,37	26,87	31,37	9,00	13,50	18,00	22,50	27,00
M 10 x 1	10,30	14,50	19,50	24,50	29,50	34,50	13,50	18,50	23,50	28,50	33,50	10,00	15,00	20,00	25,00	30,00
M 10 x 1,25	10,30	15,62	20,62	25,62	30,62	35,62	14,37	19,37	24,37	29,37	34,37	10,00	15,00	20,00	25,00	30,00
M 10 x 1,5	10,40	16,75	21,75	26,75	31,75	36,75	15,25	20,25	25,25	30,25	35,25	10,00	15,00	20,00	25,00	30,00
M 11 x 1,5	11,40	17,75	23,25	28,75	34,25	39,75	16,25	21,75	27,25	32,75	38,25	11,00	16,50	22,00	27,50	33,00
M 12 x 1,25	12,30	17,62	23,62	29,62	35,62	41,62	16,37	22,37	27,37	33,37	40,37	12,00	18,00	24,00	30,00	36,00
M 12 x 1,5	12,40	18,75	24,75	30,75	36,75	42,75	17,25	23,25	29,25	35,25	41,25	12,00	18,00	24,00	30,00	36,00
M 12 x 1,75	12,40	19,87	25,87	31,87	37,87	43,87	18,12	24,12	30,12	36,12	42,12	12,00	18,00	24,00	30,00	36,00
M 14 x 1,25	14,40	19,62	26,62	33,62	40,62	47,62	18,37	25,37	32,37	39,37	46,37	14,00	21,00	28,00	35,00	42,00
M 14 x 1,5	14,40	20,75	27,75	34,75	41,75	48,75	19,25	26,25	33,25	40,25	47,25	14,00	21,00	28,00	35,00	42,00
M 14 x 2	14,50	23,00	30,00	37,00	44,00	51,00	21,00	28,00	35,00	42,00	49,00	14,00	21,00	28,00	35,00	42,00
M 16 x 1,5	16,40	22,75	30,75	38,75	46,75	54,75	21,25	29,25	37,25	45,25	53,25	16,00	24,00	32,00	40,00	48,00
M 16 x 2	16,50	25,00	33,00	41,00	49,00	57,00	23,00	31,00	39,00	47,00	55,00	16,00	24,00	32,00	40,00	48,00
M 18 x 2	18,50	27,00	36,00	45,00	54,00	63,00	25,00	34,00	43,00	52,00	61,00	18,00	27,00	36,00	45,00	54,00
M 18 x 2,5	18,60	29,25	38,25	47,25	56,25	65,25	26,75	35,75	44,75	53,75	62,75	18,00	27,00	36,00	45,00	54,00
M 20 x 1,5	20,50	26,75	36,75	46,75	56,75	66,75	25,25	35,25	45,25	55,25	65,25	20,00	30,00	40,00	50,00	60,00
M 20 x 2	20,50	29,00	39,00	49,00	59,00	69,00	27,00	37,00	47,00	57,00	67,00	20,00	30,00	40,00	50,00	60,00
M 20 x 2,5	20,60	31,25	41,25	51,25	61,25	71,25	28,75	38,75	48,75	58,75	68,75	20,00	30,00	40,00	50,00	60,00
M 22 x 1,5	22,50	28,75	39,75	50,75	61,75	72,75	27,25	38,25	49,25	60,25	71,25	22,00	33,00	44,00	55,00	66,00
M 22 x 2	22,50	31,00	42,00	53,00	64,00	75,00	29,00	40,00	51,00	62,00	73,00	22,00	33,00	44,00	55,00	66,00
M 22 x 2,5	22,60	33,25	44,25	55,25	66,25	77,25	30,75	41,75	52,75	63,75	74,75	22,00	33,00	44,00	55,00	66,00
M 24 x 2	24,50	33,00	45,00	57,00	69,00	81,00	31,00	43,00	55,00	67,00	79,00	24,00	36,00	48,00	60,00	72,00
M 24 x 3	24,75	37,50	49,50	61,50	73,50	85,50	34,50	46,50	58,50	70,50	82,50	24,00	36,00	48,00	60,00	72,00



Ermittlung der Mindestwandstärke für Gewindeeinsätze nach DIN 8140

Minimum wall thickness for wire thread inserts according DIN 8140

d = Nenndurchmesser / Nominal diameter of the holding thread
 D = Außendurchmesser des Aufnahmegewindes /
 Outside diameter of the receiving thread
 R = Restwandstärke / Remaining wall thickness
 $R(\text{min}) = 0,375 \times D$
 $G(\text{min}) = 1,75 \times D$

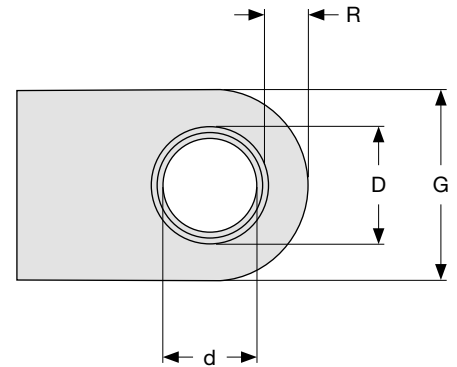

Die Mindestwandstärken werden ausschließlich mit den jeweiligen Kenngrößen ermittelt. Die angegebenen Richtformeln beziehen sich auf Guss-, Aluminium- bzw. Knetlegierungen und einer Länge des BOHRCRAFT Gewindeeinsatzes von $1,5 \times D$.

The minimum wall thicknesses are determined exclusively using the respective parameters. The given operation data refer to cast, aluminum or wrought alloys and a length of the BOHRCRAFT wire thread insert of $1.5 \times D$.

Zugfestigkeit des Aufnahmematerials Tensile strength of the parent material	Schraubenfestigkeitsklassen / Screw property class							
	4,6	5,6	6,6	6,9	9,8	10,9	12,9	14,9
< 100 N/mm ²	1,5 x D	1,5 x D	2,0 x D	2,5 x D	3,0 x D	-	-	-
100 – 150 N/mm ²	1,5 x D	1,5 x D	2,0 x D	2,0 x D	2,5 x D	2,5 x D	2,5 x D	3,0 x D
150 – 200 N/mm ²	1,0 x D	1,5 x D	1,5 x D	1,5 x D	2,0 x D	2,0 x D	2,5 x D	2,5 x D
200 – 250 N/mm ²	1,0 x D	1,0 x D	1,5 x D	1,5 x D	1,5 x D	2,0 x D	2,5 x D	2,5 x D
250 – 300 N/mm ²	1,0 x D	1,0 x D	1,0 x D	1,0 x D	1,5 x D	1,5 x D	2,0 x D	2,0 x D
300 – 350 N/mm ²	1,0 x D	1,0 x D	1,0 x D	1,0 x D	1,5 x D	1,5 x D	1,5 x D	2,0 x D
350 – 400 N/mm ²	1,0 x D	1,0 x D	1,0 x D	1,0 x D	1,0 x D	1,5 x D	1,5 x D	1,5 x D
> 400 N/mm ²	1,0 x D	1,0 x D	1,0 x D	1,0 x D	1,0 x D	1,5 x D	1,5 x D	1,5 x D

Die Werte gelten bei Innentemperatur für Werkstoffe (z. B. Aluminium) mit einem Verhältnis von (Scherspannung) / (Zugspannung) = 0,6 – 0,7.

Die Berechnung basiert darauf, dass bei der Schraubverbindung die Schraube das schwächere Glied darstellen soll.

Gewindelänge: $1,5 \times D = 1,5$ mal Nenndurchmesser

The values apply at internal temperature for materials (e.g. aluminum) with a ratio of (shear stress) / (tensile stress) = 0.6 - 0.7.

The guideline values must be assessed so that the screw is always the weakest part of the connection.

Thread length: $1,5 \times D = 1,5$ times nominal diameter



Anwendungsempfehlung für Stufenbohrer Application recommendation for step drills

Ø mm	Baustahl / Steel		Gusseisen Cast iron	CuZn-Legierung CuZn-alloys		ALU-Legierung ALU-alloys	Thermoplaste Thermoplastics	Duroplaste Thermoset plastics
	unlegiert unalloyed	legiert alloyed		spröde tough	zäh brittle			
	≤ 700 N/mm	≤ 1.000 N/mm	≤ 250 N/mm			≤ 11 % Si		
U/min • RPM								
4,0 – 12,0	800 – 2400	500 – 1600	300 – 800	1600 – 4800	900 – 2800	800 – 2400	500 – 1600	400 – 1200
4,0 – 20,0	500 – 2400	300 – 1600	200 – 800	1000 – 4800	600 – 2800	500 – 2400	300 – 1600	200 – 1200
4,0 – 30,0	300 – 2400	200 – 1600	100 – 800	600 – 4800	400 – 2800	300 – 2400	200 – 1600	200 – 1200
4,0 – 39,0	300 – 1600	200 – 1100	100 – 500	500 – 3200	300 – 1900	300 – 1600	200 – 1100	100 – 800
6,0 – 26,75	400 – 1600	200 – 1100	100 – 500	700 – 3200	400 – 1900	400 – 1600	200 – 1100	200 – 800
4,0 – 32,0	300 – 2400	200 – 1600	100 – 800	600 – 4800	300 – 2800	300 – 2400	200 – 1600	100 – 1200
6,0 – 32,0	300 – 1600	200 – 1100	100 – 500	600 – 3200	300 – 1900	300 – 1600	200 – 1100	100 – 800
5,0 – 28,0	300 – 1900	200 – 1300	100 – 600	700 – 3800	400 – 2200	300 – 1900	200 – 1300	200 – 1000
6,0 – 37,0	300 – 1600	200 – 1100	100 – 500	500 – 3200	300 – 1900	300 – 1600	200 – 1100	100 – 800
6,0 – 25,0	400 – 1600	300 – 1100	100 – 500	800 – 3200	400 – 1900	400 – 1600	300 – 1100	200 – 800
5,3 – 30,5	300 – 1800	200 – 1200	100 – 600	600 – 3600	400 – 2100	300 – 1800	200 – 1200	200 – 900
6,5 – 32,5	300 – 1500	200 – 1000	100 – 500	600 – 2900	300 – 700	300 – 1500	200 – 1000	100 – 700
5,3 – 38,5	200 – 1800	200 – 1200	100 – 600	500 – 3600	300 – 2100	200 – 1800	200 – 1200	100 – 900
6,5 – 40,5	200 – 1500	200 – 1000	100 – 500	500 – 2900	300 – 1700	200 – 1500	200 – 1000	100 – 700
6,5 – 32,5	300 – 1500	200 – 1000	100 – 500	600 – 2900	300 – 1700	300 – 1500	200 – 1000	100 – 700
12,0 – 20,0	500 – 800	300 – 500	200 – 300	600 – 1600	600 – 900	500 – 800	300 – 500	200 – 400
20,0 – 30,0	300 – 500	200 – 300	100 – 200	600 – 1000	400 – 600	300 – 500	200 – 300	200 – 200

Anwendungsempfehlung für Blechschälbohrer Application recommendation for sheet metal drills

Ø mm	Baustahl / Steel		Gusseisen Cast iron	CuZn-Legierung CuZn-alloys		ALU-Legierung ALU-alloys	Thermoplaste Thermoplastics	Duroplaste Thermoset plastics
	unlegiert unalloyed	legiert alloyed		spröde tough	zäh brittle			
	≤ 700 N/mm	≤ 1.000 N/mm	≤ 250 N/mm			≤ 11 % Si		
U/min • RPM								
3,0 – 14,0	3185 – 682	2123 – 455	1592 – 341	6369 – 1365	3715 – 796	3185 – 682	2123 – 455	1592 – 341
4,0 – 20,0	1911 – 478	1274 – 318	955 – 239	3822 – 955	2229 – 557	1911 – 478	1274 – 318	955 – 239
16,0 – 30,5	597 – 313	398 – 209	299 – 157	1194 – 627	697 – 365	597 – 313	398 – 209	299 – 157
24,0 – 40,0	398 – 239	265 – 159	199 – 119	796 – 478	464 – 279	398 – 239	265 – 159	199 – 119
36,0 – 50,0	265 – 191	177 – 127	133 – 96	531 – 382	310 – 223	265 – 191	177 – 127	133 – 96
40,0 – 61,0	239 – 157	159 – 104	119 – 78	478 – 313	279 – 183	239 – 157	159 – 104	119 – 78
5,0 – 25,4	1911 – 376	1274 – 251	955 – 188	3822 – 752	2229 – 439	1911 – 376	1274 – 251	955 – 188
5,0 – 31,0	1911 – 308	1274 – 205	955 – 154	3822 – 616	2229 – 360	1911 – 308	1274 – 205	955 – 154
5,0 – 22,5	1911 – 425	1274 – 283	955 – 212	3822 – 849	2229 – 495	1911 – 425	1274 – 283	955 – 212

Anwendungsempfehlung für Kegelsenker

Application recommendation for countersinks

Ø mm	Baustahl / Steel		Gusseisen Cast iron	CuZn-Legierung CuZn-alloys		ALU-Legierung ALU-alloys	Thermoplaste Thermoplastics	Duroplaste Thermoset plastics
	unlegiert unalloyed	legiert alloyed		spröde tough	zäh brittle			
	≤ 700 N/mm	≤ 1.000 N/mm	≤ 250 N/mm			≤ 11 % Si		
U/min • RPM								
4,3	1296	741	667	2963	1481	1481	1111	741
5,0	1115	637	574	2548	1274	1274	955	637
5,3	1052	601	541	2404	1202	1202	901	601
5,8	961	549	494	2196	1098	1098	824	549
6,0	929	531	478	2123	1062	1062	796	531
6,3	885	506	455	2022	1011	1011	758	506
7,0	796	455	410	1820	910	910	682	455
7,3	764	436	393	1745	873	873	654	436
8,0	697	398	358	1592	796	796	597	398
8,3	672	384	346	1535	767	767	576	384
9,4	593	339	305	1355	678	678	508	339
10,0	558	318	287	1274	637	637	478	318
10,4	536	306	276	1225	612	612	459	306
11,5	485	277	250	1108	554	554	415	277
12,0	465	265	239	1062	531	531	398	265
12,4	450	257	231	1027	514	514	385	257
12,5	446	255	230	1019	510	510	382	255
13,4	416	238	214	951	475	475	356	238
15,0	372	212	191	849	425	425	318	212
16,0	349	199	179	796	398	398	299	199
16,5	338	193	174	772	386	386	290	193
19,0	293	168	151	670	335	335	251	168
20,0	279	159	143	637	318	318	239	159
20,5	272	155	140	621	311	311	233	155
23,0	243	138	125	554	277	277	208	138
25,0	223	127	115	510	255	255	191	127
26,0	215	122	110	490	245	245	184	122
28,0	199	114	103	455	227	227	171	114
30,0	186	106	96	425	212	212	159	106
31,0	180	103	93	411	205	205	154	103
31,5	177	101	91	404	202	202	152	101
34,0	164	94	85	375	187	187	141	94
37,0	151	86	78	344	172	172	129	86
40,0	139	80	72	318	159	159	119	80
50,0	112	64	58	255	127	127	96	64
63,0	89	51	46	202	101	101	76	51
80,0	70	40	36	159	80	80	60	40



Anwendungsempfehlung für Hartmetall Frässtifte

Application recommendation for carbide rotary burrs

Werkstoffgruppen Materials group		Zahnung Toothing	Schnittgeschwindigkeit Cutting speeds
Stahl, Stahlguss Steel, cast steel	Ungehärtete, nicht vergütete Stähle bis 1200 N/mm ² (≤ 38 HRC) Steels up to 1,200 N/mm ² (≤ 38 HRC)	Z3-X	450 – 600 m/min
	Gehärtete, vergütete Stähle über 1200 N/mm ² (> 38 HRC) Hardened, heattreated steels over 1,200 N/mm ² (> 38 HRC)	Z3-X Z4 Z5	250 – 350 m/min
Edelstahl (INOX) Stainless steel	Rost- und säurebeständige Stähle Rust and acid-resistant steels	Z3-X Z4 Z5	250 – 350 m/min
NE-Metalle Nonferrous metals	Weiche NE-Metalle, Buntmetalle Soft non-ferrous metals	Z-ALU	600 – 900 m/min
	Harte NE-Metalle Hard non-ferrous metals	Z3-X Z4	250 – 350 m/min
	Hochwarmfeste Werkstoffe High-temperatureresistant materials	Z3-X Z4 Z5	300 – 450 m/min
Gusseisen Cast iron	Graues Gusseisen, weißes Gusseisen Grey cast iron, white cast iron	Z3-X	450 – 600 m/min

Schnittgeschwindigkeiten für Hartmetall Frässtifte

Cutting speeds for carbide rotary burrs

Frässtift Rotary burr Ø mm	Schnittgeschwindigkeit / Cutting Speeds Vc = m/min							
	250	300	350	400	450	500	600	900
	U/min / RPM							
2	40.000	48.000	56.000	64.000	72.000	80.000	95.000	143.000
4	20.000	24.000	28.000	32.000	36.000	40.000	48.000	72.000
6	13.000	16.000	19.000	21.000	24.000	27.000	32.000	48.000
8	10.000	12.000	14.000	16.000	18.000	20.000	24.000	36.000
10	8.000	10.000	11.000	13.000	14.000	16.000	19.000	29.000
12	7.000	8.000	9.000	11.000	12.000	13.000	16.000	24.000
16	5.000	6.000	7.000	8.000	9.000	10.000	12.000	18.000
19	4.000	5.000	6.000	6.000	7.000	8.000	10.000	14.000

Hinweis: Die oben angegebenen Drehzahlbereiche gelten für die Ausführung mit normaler Schaftlänge. Die maximale empfohlene Drehzahl für **Frässtifte mit langem Schaft** entnehmen Sie der Spalte Vc = 250 m/min.

Note: The above indicated speeds are valid for the normal shank-length. You can find the maximum recommended speed for **burrs with long shank** under column Vc = 250 m/min.

Schnittgeschwindigkeiten für HSS Frässtifte Cutting speeds for HSS rotary burrs

Frässtift Rotary burr Ø mm	Schnittgeschwindigkeit / Cutting speed Vc = m/min					
	50	100	150	200	250	300
	U/min / RPM					
2	8.000	16.000	24.000	32.000	40.000	48.000
4	4.000	8.000	12.000	16.000	20.000	24.000
6	3.000	5.000	8.000	11.000	13.000	16.000
8	2.000	4.000	6.000	8.000	10.000	12.000
10	2.000	3.000	5.000	6.000	8.000	10.000
12	1.000	3.000	4.000	5.000	7.000	8.000
16	1.000	2.000	3.000	4.000	5.000	6.000

Lieferbare Beschichtungen Available coatings

	Farbe Colour	Multilayer Multilayer	Härte Hardness	Schichtdicke Coating thickness	max. Einsatz- temperatur Application temperature	Reibkoeffizient gegen Stahl Friction against Steel	Kühlung empfohlen Cooling recommended	Trocken- bearbeitung Dry cutting
TiN	goldgelb		ca. 2.300 HV	2 – 5 µm	~ 700°	0,67		
TiAlN	violett		ca. 3.300 HV	2 – 5 µm	~ 900°	0,37		
TiCN	blausilber		ca. 3.000 HV	2 – 5 µm	~ 500°	0,38		
AlTiN	dunkelviolett		ca. 3.300 HV	2 – 5 µm	~ 800°	0,50		
AlCro	blaugrau		ca. 3.200 HV	2 – 5 µm	~ 1.100°	0,35		
Blue+	blaubunt		ca. 3.000HV	2 – 5 µm	~ 700°	0,50		
ZRN+	blassgold		ca. 2.600HV	2 – 5 µm	~ 800°	0,40		
Hardlube	dunkelgrau		ca. 3.300 HV	3 – 5 µm	~ 800°	0,15		
VAP	schwarz		-	-	-	-		



Anwendungsempfehlung für Bi-Metall Lochsägen HSS / HSS-E (Co8)

Application recommendation for Bi-Metal hole saws HSS / HSS-E (Co8)

Ø mm	Ø Zoll / Inch	Stahl Milled steel	Rostfreier Stahl Stainless steel	Guss Cast	Messing / Kupfer Brass / Copper	ALU	Thermo- plaste Thermo- plastics	Duroplaste Thermoset plastics	Holz Wood
		U/min • RPM							
14	9/16"	580	300	400	790	900	455	341	910
16	5/8"	550	275	365	730	825	398	299	796
17	11/16"	500	250	330	665	750	375	281	749
19	3/4"	460	230	300	600	690	335	251	670
21	13/16"	425	210	280	560	630	303	227	607
22	7/8"	390	195	260	520	585	290	217	579
24	15/16"	370	185	245	495	555	265	199	531
25	1"	350	175	235	470	525	255	191	510
27	1.1/16"	325	160	215	435	480	236	177	472
29	1 1/8"	300	150	200	400	450	220	165	439
30	1.3/16"	285	145	190	380	425	212	159	425
32	1.1/4"	275	140	180	360	410	199	149	398
33	1.5/16"	268	135	175	345	390	193	145	386
35	1.3/8"	250	125	165	330	375	182	136	364
37	1.7/16"	240	120	160	315	360	172	129	344
38	1.1/2"	240	120	160	315	360	168	126	335
40	1.9/16"	220	110	145	290	330	159	119	318
41	1.5/8"	210	105	140	280	315	155	117	311
43	1.11/16"	205	100	135	270	305	148	111	296
44	1.3/4"	195	95	130	250	295	145	109	290
46	1.13/16"	190	95	125	250	285	138	104	277
48	1.7/8"	180	90	120	240	270	133	100	265
51	2"	170	85	115	230	255	125	94	250
52	2.1/16"	165	80	110	220	245	122	92	245
54	2.1/8"	160	80	105	210	240	118	88	236
57	2.1/4"	150	75	100	200	225	112	84	223
59	2.5/16"	145	75	100	195	225	108	81	216
60	2.3/8"	140	70	95	190	220	106	80	212
64	2.1/2"	135	65	90	180	205	100	75	199
65	2.9/16"	130	65	85	175	200	98	73	196
67	2.5/8"	130	65	85	170	195	95	71	190
68	2.11/16"	130	65	85	170	195	94	70	187
70	2.3/4"	125	60	80	160	185	91	68	182
73	2.7/8"	120	60	80	160	180	87	65	175
76	3"	115	55	75	150	170	84	63	168
79	3.1/8"	110	55	70	140	165	81	60	161
83	3.1/4"	105	50	70	140	155	77	58	153
86	3.3/8"	100	50	65	130	150	74	56	148
89	3.1/2"	95	45	65	130	145	72	54	143
92	3.5/8"	95	45	60	120	140	69	52	138
95	3.3/4"	90	45	60	120	135	67	50	134
98	3.7/8"	90	45	60	120	135	65	49	130
102	4"	85	40	55	110	130	62	47	125
105	4.1/8"	80	40	55	110	120	61	45	121
108	4.1/4"	80	40	55	110	120	59	44	118
111	4.3/8"	80	40	50	100	120	57	43	115
114	4.1/2"	75	35	50	100	105	56	42	112
121	4.3/4"	70	35	45	90	95	53	39	105
127	5"	65	30	40	85	90	50	38	100
140	5.1/2"	65	30	35	80	85	45	34	91
152	6"	55	25	35	75	85	42	31	84
160	6.1/3"	55	25	35	75	85	40	30	80
168	6.5/8"	55	25	35	75	85	38	28	76
177	7"	50	20	30	70	80	36	27	72
210	8.1/4"	45	20	30	70	80	30	23	61



Code	Seite Page	Code	Seite Page	Code	Seite Page	Code	Seite Page	Code	Seite Page	Code	Seite Page
0080	436	1659	287	1966	405	4148	194	4700	254	5500	138
0081	435	1660	287	1970	406	4149	204	4701	255	5505	139
0130	317, 437	1661	288	1971	407 - 408	4150	192 - 193	4800	256	5506	139
1100	34 - 37	1670	161	1972	408	4151	192	4801	256	5510	140
1104	87	1671	162	1973	409	4152	196 - 197	4802	257	5511	140
1109	38	1672	163	1974	408 - 409	4153	196	5100	302	5515	141
1110	43	1673	164	1975	409	4154	201	5101	302	5516	141
1119	45 - 46	1674	165	1980	405	4155	201	5102	302	5520	142
1120	39 - 42	1675	166	1990	405	4156	221	5103	302	5521	142
1121	45 - 46	1700	268	1991	405	4157	196 - 197	5104	302	5525	143
1121-red.	47	1700-120	273	2100	336	4158	196	5105	303	5526	143
1122	48 - 49	1700-60	272	2150	336	4159	208	5106	303	5530	144
1122-red.	50	1700-75	273	2250	338	4160	211	5107	303	5531	144
1123	48 - 49	1701	268	2251	338	4161	207	5108	303	5535	145
1124	51 - 52	1702	268	2252	338	4162	207	5109	303	5536	145
1127	60	1703-EL	270	2260	337	4163	198	5110	304	5540	146
1128	61	1703-L	270	2261	337	4164	198	5111	304	5541	146
1129	53	1704	272	2270	340	4165	219	5112	304	5545	147
1130	44	1705	271	2280	339	4166	219	5113	304	5546	147
1131	62	1706	275	2301	364	4167	199	5114	304	5550	148
1140	63 - 65	1707	275	2302	364	4168	199	5115	305	5555	149
1140-red.	66	1708	275	2590	352 - 353	4169	200	5116	305	5900	313, 316
1141	68 - 69	1710	269	2610	349 - 351	4170	200	5117	305	5901	316
1142	70 - 71	1714	267	2612	344 - 346	4171	210	5118	305	5902	297
1143	68 - 69	1715	266	2615	347 - 348	4172	209	5119	305	5903	316
1144	70 - 71	1716	275	2620	354 - 355	4173	202	5120	306	5905	313, 316
1147	74 - 75	1717	275	2650	356	4174	202	5121	306	6100	419
1148	74 - 75	1718	275	2660	357	4175	226	5124	306	6120	417
1149	72 - 73	1719	266	2700	341	4176	226	5125	307	6120-red.	417
1200	88	1720	274	2701	361, 363	4177	203	5126	307	6121	417
1201	54 - 55	1721	274	2702	360	4178	203	5127	307	6122	417
1202	56 - 57	1730	264	2703	362	4179	200	5128	307	6123	418
1203	67	1731	264	2710	341	4180	200	5129	307	6130	418
1204	58	1732	265	2720	364	4181	198	5130	308	6130-red.	419
1250	89	1733	265	2730	366	4182	198	5131	308	6131	418
1255	90	1740	282	2735	366	4183	198	5133	308	6132	419
1260	91	1740-A	283	2740	367	4184	198	5134	308	6133	419
1265	92	1741	282	2745	367	4185	199	5135	309	6140	420
1266	92	1741-A	283	2750	368	4186	199	5136	309	6141	420
1300	94	1742	282	3100	372	4187	199	5140	309	6143	421
1301	95	1743	283	3101	372	4188	199	5141	309	6150	421
1310	95	1760	280	3110	373	4189	202	5145	310	6160	422
1340	78	1760-¼"	281	3120	378	4190	202	5146	310	6170	422
1350	79	1761	280	3130	379	4191	203	5150	311	6180	422
1353	80	1762	280	3200	380 - 381	4192	203	5151	311	6190	422
1360	81	1763	278	3210	382	4193	206	5153	311	6200	423
1361	81	1764	278	3250	375	4196	234	5154	311	6210	423
1362	82	1765	279	3261	376	4197	234	5155	310	6220	423
1400	83	1766	279	3410	383	4198	238	5156	310	6230	423
1410	84	1767	278	3411	383	4199	238	5159	310	6300	425
1420	85	1801	102	3450	374	4200	182	5160	312	6310	425
1440	86	1802	102	3650	377	4201	183	5161	312	6330	425
1450	96 - 97	1803	102	3700	374	4202	216 - 217	5170	312	6350	426
1451	98 - 99	1805	102	4100	178 - 179	4203	223	5205	294	6351	426
1455	101	1806	103	4101	214 - 215	4204	186	5210	294	6400	429
1458	331	1807	103	4102	222	4205	229	5215	295	6500	427
1459	331	1810	102	4103	228	4206	232	5230	295	6500-65	427
1460	332	1811	102	4104	231	4207	236	5250	296	6501	428
1461	333	1812	102	4105	235	4208	224	5255	296	6502	428
1462	333	1820	271	4109	181	4209	185	5300	122 - 123	6505	428
1463	332	1900	388 - 389	4110	180	4210	184	5301	122 - 123	6614	432
1465	328, 329	1901	390 - 391	4111	190	4240	205	5305	124	6615	432
1466	328	1910	387	4120	187	4241	205	5306	124	6616	432
1467	329	1911	387	4121	189	4243	212	5310	125	6617	432
1468	330	1913	387	4125	188	4245	213	5311	125	6620	433
1469	330	1915	412	4129	191	4247	227	5315	129	6624	433
1470	100	1916	413	4130	240	4300	242	5316	129	6645	433
1500	110	1920	157	4131	218	4302	243	5320	130	6645-¼"	429
1502	106 - 107	1925	157	4132	225	4400	242	5321	130	6710	430
1504	108 - 109	1930	392	4133	230	4500	243	5325	126	6712	430
1508	76 - 77	1935	393	4134	233	4501	241	5326	126	6713	430
1600	93	1936	393	4135	237	4600	248	5330	127	6714	430
1625	276	1950	153	4136	239	4601	248, 250	5331	127	6715	431
1626	276	1951	154	4139	220	4602	248	5335	128	6716	431
1648	291	1952	155	4140	192 - 193	4603	248	5336	128	6720	431
1650	286	1955	156	4141	192	4604	248	5345	118	6900	424
1651	286	1956	156	4142	194 - 195	4610	248	5350	119	9600	245
1652	289	1957	156	4143	194	4611	248, 251	5355	120	9651	241
1653	288	1960	400 - 401	4144	201	4612	248	5365	121	9690	320 - 324
1654	288	1961	401 - 402	4145	201	4613	248	5415	132	9700	244
1655	290	1964	403	4146	221	4614	248	5420	133	9990	440 - 441
1656	288	1965	403 - 404	4147	194 - 195	4615	249, 253	5435	131		



GELTUNG DER BEDINGUNGEN

1. Unsere Lieferungen und Leistungen erfolgen ausschließlich aufgrund dieser Geschäftsbedingungen. Andere Bedingungen werden nicht Vertragsinhalt, und zwar auch dann, wenn wir ihnen nicht ausdrücklich widersprechen.

Diese Bedingungen gelten ausschließlich bei Verträgen mit Unternehmern.

ANGEBOT UND VERTRAGSSCHLUSS

2. Alle Angebote sind für uns freibleibend, verpflichten uns nicht zur Auftragsannahme und gelten vorbehaltlich der Möglichkeit der Warenbeschaffung. An Bestellungen ist der Besteller zwei Wochen lang gebunden. Nach Ablauf dieser Frist kann der Besteller die Bestellung widerrufen. Ein Vertrag kommt nur zustande, wenn wir die Bestellung durch Auftragsbestätigung, eine andere ausdrückliche Bestätigung oder durch tatsächliche Ausführung der Bestellung auf der Grundlage dieser Bedingungen annehmen. Im Falle eines mündlichen Vertragsabschlusses ist der Inhalt unseres Bestätigungsschreibens maßgeblich, wenn diesem Inhalt nicht unverzüglich widersprochen worden ist.

3. Handelsübliche Abweichungen von den in Katalogen, Preislisten oder den zum Angebot gehörenden Unterlagen enthaltenen Angaben, Zeichnungen, Abbildungen und Leistungsbeschreibungen sind im Rahmen des Zumutbaren zulässig.

PREISSTELLUNG

4. Unsere Preise verstehen sich in EURO. Alle Preise sind Nettopreise. Hinzukommen die jeweils geltende gesetzliche Umsatzsteuer sowie Versand-, Verpackungs-, Porto-, Fracht-, Frachtneben- und Versicherungskosten, Gebühren und Zölle. Soweit nicht anders vereinbart, liefern wir im Inland ab € 150,00 Nettowarenwert frei Haus. Für Aufträge unter € 45,00 berechnen wir eine Pauschale von € 12,00 und für Aufträge ab € 45,00 bis € 150,00 berechnen wir Versandkosten in Höhe von € 6,50 pro Paket. Auslandsendungen ab € 750,- werden frei deutsche Grenze geliefert. Der Mindestauftragswert bei Auslandsbestellungen beträgt € 750,00. Der Mindestauftragswert bei Bestellungen aus Ländern außerhalb der Europäischen Union beträgt € 1.500,- bzw. nach Vereinbarung. Eventuelle Kosten, die durch Eröffnung eines Akkreditivs entstehen, gehen stets zu Lasten der Besteller.

5. Sollte eine Lieferzeit von mehr als drei Monaten vereinbart sein oder verzögert sich die Auslieferung um mehr als drei Monate aus Gründen, die der Besteller zu vertreten hat, dann sind wir zu Preis Anpassungen berechtigt, soweit sich während dieser Zeit Kosten und Löhne erhöhen.

LIEFERUNG

6. Die Lieferfrist beginnt, sobald der Vertrag abgeschlossen ist, alle vom Besteller zu machenden Angaben, insbesondere über Lieferadressen, besondere Versandart und sonstige Besonderheiten vorliegen und alle nach dem Vertrag oder der Verkehrsrisse vom Besteller zu erfüllende Voraussetzungen erbracht sind. Die angegebenen Lieferzeiten sind nur als annähernd zu betrachten, es sei denn, ein bestimmter Lieferzeitpunkt wurde ausdrücklich zugesagt. Wird die angegebene Lieferzeit um mehr als zwei Wochen überschritten, so hat der Besteller das Recht, eine angemessene Nachfrist zu setzen. Wurde ein bestimmter Lieferzeitpunkt überschritten, kann der Besteller die angemessene Nachfrist sofort setzen.

7. Auch wenn eine kalendermäßig bestimmte Lieferzeit vereinbart ist, liegt noch kein Fixhandelsgeschäft im Sinne von § 376 Abs. 1 HGB vor. Hierfür bedarf es einer ausdrücklichen Einigung der Vertragspartner darüber, dass der Vertrag bei Nichteinhaltung der Lieferfrist ohne weiteres durch Rücktritt beendet und, sofern uns ein Verschulden trifft, Schadenersatz wegen Nichterfüllung verlangt werden kann.

8. Liefer- und Leistungsverzögerungen aufgrund höherer Gewalt, die uns die Lieferung wesentlich erschweren oder unmöglich machen – hierzu gehören beispielsweise Arbeitskämpfe, Unruhen, Unwetter- sowie das Ausbleiben von Zulieferungen unserer Lieferanten, haben wir auch bei verbindlich vereinbarten Lieferterminen das Recht, diesen Termin um die Dauer der Behinderung zuzüglich einer angemessenen Anlaufzeit hinauszuschieben oder wegen des noch nicht erfüllten Teils ganz oder teilweise vom Vertrag zurückzutreten, ohne dass der Besteller hieraus Schadensersatzansprüche herleiten kann. Treten die vorgenannten Hindernisse beim Besteller ein, so gelten die gleichen Rechtsfolgen auch für seine Abnahmeverpflichtung.

9. Die Vertragspartner sind verpflichtet, dem anderen Teil Anfang und Ende von Hindernissen der vorbezeichneten Art unverzüglich mitzuteilen.

10. Teillieferungen und Teilleistungen sind, soweit handelsüblich, zulässig und werden gesondert in Rechnung gestellt. Sie sind ausnahmsweise dann unzulässig, wenn die teilweise Erfüllung des Vertrages für den Besteller kein Interesse hat.

11. Beeinflussen spätere Änderungen des Vertrages durch den Besteller die Lieferfrist, so verlängert sich diese in angemessenem Umfang.

VERLÄNGERTER EIGENTUMSVORBEHALT MIT VERARBEITUNGSKLAUSEL

12. Die Ware bleibt unser Eigentum, bis unseren gegenwärtigen und künftigen Ansprüchen gegen den Besteller, sofern sie mit der gelieferten Ware in Zusammenhang stehen, erfüllt sind.

13. Der Besteller ist berechtigt, die Vorbehaltsware weiter zu veräußern, soweit dies dem ordentlichen Geschäftsengang entspricht. Er tritt uns jedoch bereits jetzt alle Forderung aus dieser Weiterveräußerung ab. Hereingenommene Wechsel indossiert der Besteller an uns und verwahrt diese Wechsel für uns.

Dies gilt unabhängig davon, ob die Vorbehaltsware ohne oder nach Verarbeitung weiterveräußert oder ob sie mit einem Grundstück oder beweglichen Sachen verbunden wird oder nicht. Wird die Vorbehaltsware nach Verbindung, Verarbeitung oder mit anderen Waren zusammen weiterveräußert, so gilt die Forderung des Bestellers gegen dessen Abnehmer, in Höhe des zwischen uns und dem Besteller für die Vorbehaltsware vereinbarten Preises, als abgetreten.

14. Der Besteller ist zur Einziehung dieser Forderung berechtigt. Unsere Befugnis, die an ihn abgetretene Forderung selbst einzuziehen, bleibt davon unberührt. Wir verpflichten uns jedoch, von diesem Recht keinen Gebrauch zu machen, solange der Besteller seinen Zahlungsverpflichtungen ordnungsgemäß nachkommt.

15. Verarbeitung oder Umbildung der Vorbehaltsware erfolgen für uns als Hersteller im Sinne des § 950 BGB, ohne uns zu verpflichten.

16. Wird die in unserem Eigentum stehende Ware mit anderen Gegenständen verarbeitet, die im Eigentum Dritter stehen, so erwerben wir Miteigentum an der neuen Sache, und zwar im Verhältnis des Verkehrswerts unserer Ware zum Wert der anderen verarbeiteten Gegenstände zur Zeit der Verarbeitung. Der Besteller wird die neue Sache mit der Sorgfalt eines ordentlichen Kaufmannes kostenlos für uns verwahren.

17. Wir werden uns zustehende Sicherungen auf Anforderung freigeben, soweit ihr Wert die zu sichernden und noch nicht geglichenen Forderungen um mehr als 20 Prozent übersteigt.

18. Nehmen wir Zahlungsmittel Wechsel entgegen, so besteht der Eigentumsvorbehalt solange fort, bis feststeht, dass wir unsererseits aus diesem Wechsel nicht mehr in Anspruch genommen werden können.

GEWÄHRLEISTUNG UND HAFTUNG

19. Die Gewährleistungszeit ist in jedem Falle beschränkt auf die Dauer eines Jahres. Wir leisten Gewähr für von uns zu vertretende Mängel nach unserer Wahl durch Nachbesserung oder Ersatzlieferung. Die Gewährleistung ist ausgeschlossen, wenn unsere Ware zu einem anderen als dem uns angegebenen Zweck oder nicht entsprechend unserer Freigabe eingesetzt wird.

20. Die Haftung für entgangenen Gewinn und Betriebsunterbrechung ist, gleich aus welchem Rechtsgrund, ausgeschlossen, ebenso für unvorhersehbare Schäden oder Mangelfolgeschäden. Die Haftung bei Verletzung von Leben, Körper und Gesundheit sowie die Haftung für grobes Verschulden und Vorsatz sind jedoch weder ausgeschlossen noch begrenzt.

21. Von uns gemachte Angaben über unsere Produkte beziehen sich allein auf Eigenschaften dieser Produkte selbst, nicht jedoch auf ihre Verwendbarkeit oder Einsatzfähigkeit in bestimmten Verfahren, Maschinen, Vorrichtungen oder zu bestimmten Zwecken, bei denen andere als von uns gelieferte Produkte eingesetzt werden.

22. Eine anwendungstechnische Beratung wird nur dann vertraglich geschuldet, wenn dies besonders vereinbart worden ist. Diese Beratung ist gesondert zu vergüten. Der Besteller hat grundsätzlich selbst die Eignung unserer Waren für die von ihm beabsichtigten Zwecke und Verfahren zu prüfen und zu überwachen. Für Beratungsfehler wird auch in diesem Falle nur dann gehaftet, wenn uns vollständig alle relevanten Angaben über zu erwartende Belastungen, Einsatzdauer, Beanspruchung, Materialien, Drücke und Temperaturen und sonst möglicherweise wichtige Parameter übermittelt worden sind. In jedem Falle obliegt es dem Besteller, einen Probelauf durchzuführen. Auch im Falle des Abschlusses eines Beratungsvertrages oder einer sonstige begründeten Haftung für eine falsche Beratung haften wir nur für den Schadensbetrag, der entstanden wäre, wenn ein ordnungsgemäßer Probelauf durchgeführt worden wäre.

23. Transportschäden und daraus eventuell resultierende Fehlmengen müssen dem jeweiligen Frachtführer angezeigt werden.

24. Für Fehler durch unsachgemäße Behandlung oder natürlichen Verschleiß übernehmen wir keine Gewähr.

25. Die Haftung für einfache Fahrlässigkeit unserer Geschäftsführer und Erfüllungsgehilfen für die Verletzung vertraglicher Nebenpflichten ist ausgeschlossen. Wurde eine wesentliche Vertragspflicht durch uns verletzt, haften wir nur für den vertragstypischen, vernünftigerweise vorhersehbaren Schaden.

RÜCKSENDUNGEN

26. Etwaige Rücksendungen dürfen nur nach vorheriger Absprache und nur mit unserer ausdrücklichen Genehmigung durchgeführt werden. Hierbei werden, außer bei berechtigten Qualitätsmängeln, 85 % des ursprünglichen Rechnungswertes gutgeschrieben.

ZAHLUNGSBEDINGUNGEN

27. Soweit nichts anderes vereinbart, sind alle Rechnungen nach erfolgter Warenlieferung innerhalb von 30 Tagen ab Rechnungsdatum ohne Abzug zur Zahlung fällig.

28. Haben wir teilweise fehlerhafte Ware geliefert, ist unser Besteller dennoch verpflichtet, die Zahlung für den fehlerfreien Anteil zu leisten.

29. Eine Aufrechnung gegen unsere Forderungen ist nur mit rechtskräftigen festgestellten oder unbestrittenen Gegenansprüchen zulässig.

30. Bei Überschreitung des Zahlungszieles sind wir berechtigt, auch ohne Mahnung bankübliche Zinsen zu berechnen. Als banküblich gelten die gesetzlichen Verzugszinsen, wobei es jedem Vertragspartner vorbehalten bleibt, nachzuweisen dass die banküblichen Zinsen höher oder niedriger sind.

31. Wechsel und Schecks werden nur nach Vereinbarung sowie nur erfüllungshalber und unter der Voraussetzungen ihrer Diskontierbarkeit angenommen. Diskontospesen werden vom Tage der Fälligkeit des Rechnungsbetrages an berechnet. Eine Gewähr für richtige Vorlage des Wechsels und für Erhebung von Wechselprotest wird ausgeschlossen.

32. Schaltet der Besteller eine Zentralregulierungsgesellschaft ein, tritt der schuldbefreiende Rechnungsausgleich erst mit Zahlungsgutschrift auf unserem Konto ein.

33. Verschlechtern sich die Vermögens- und Kreditverhältnisse des Bestellers erheblich mit der Folge einer Gefährdung unseres Anspruchs auf Zahlung, so sind wir unbeschadet der Vereinbarung eines Zahlungszieles berechtigt, die gesamte Restschuld sofort fällig zu stellen. In diesem Falle steht es uns frei, für weitere Lieferungen Vorauszahlungen oder Sicherheitsleistungen jeweils in angemessener Höhe zu verlangen und unsere Leistung bis zu Erfüllung unseres Verlangens aussetzen. Bei Verweigerung des Bestellers oder Fristablauf können wir vom Vertrag zurücktreten oder Schadenersatz wegen Nichterfüllung fordern.

VERKAUFSHILFEN

34. Verkaufs- und Präsentationshilfe, die dem Besteller kostenlos zur Verfügung gestellt werden, bleiben unser Eigentum und können jederzeit zurückgefordert werden. Während der Nutzung der Verkaufs- und Präsentationshilfen durch den Besteller geht jedes damit verbundene Risiko auf ihn über. Er verpflichtet sich, die Verkaufs- und Präsentationshilfen nur mit unseren Waren zu bestücken und bei von ihm zu vertretendem Verlust oder Beschädigung Ersatz zu leisten.

GEHEIMHALTUNG

35. Falls nicht ausdrücklich schriftlich etwas anderes vereinbart ist, gelten die diesem Vertragsverhältnis zugrunde liegenden Informationen nicht als vertraulich.

ANWENDBARES RECHT, GERICHTSSTAND

36. Für diese Geschäftsbedingungen und die gesamten Rechtsbeziehungen zwischen den Vertragspartnern gilt das Recht der Bundesrepublik Deutschland. Die Anwendung des Übereinkommens der Vereinten Nationen vom 11. April 1980 über Verträge über den Warenkauf (CISG – „Wiener Kaufrecht“) ist ausgeschlossen.

37. Für alle Rechtsstreitigkeiten, auch im Rahmen eines Wechsel- und/oder Scheckprozesses ist unser Geschäftssitz Gerichtsstand, soweit der Besteller Vollkaufmann, eine juristische Person des öffentlichen Rechts oder ein öffentlich-rechtliches Sondervermögen ist. Wir sind auch berechtigt, am Sitz des Bestellers zu klagen.

SALVATORISCHE KLAUSEL

38. Sollte eine Bestimmung in diesen Geschäftsbedingungen oder eine Bestimmung im Rahmen sonstiger Vereinbarungen unwirksam sein oder werden, so wird hiervon die Wirksamkeit des Vertrages im übrigen nicht berührt. In diesem Fall sind die Vertragspartner verpflichtet, die unwirksame Bestimmung durch eine ihr im wirtschaftlichen Erfolg möglichst gleichkommende Regelung zu ersetzen.

ABTRETUNGSVERBOT

39. Gegen uns gerichtete Ansprüche aus diesem Vertrag dürfen nur mit unserer Zustimmung an Dritte abgetreten oder übertragen werden.

Eventuelle Druckfehler oder Änderungen berechtigen nicht zu Ansprüchen. Nachdruck nur mit schriftlicher Genehmigung gestattet.

KATALOG / CATALOGUE 2024



Energe d.o.o.

Cesta na Brdo 85, 1000 Ljubljana
tel:+386 1 256 10 56, fax:+386 1 256 10 55
mailto:info@energe.si, <http://www.energe.si>

