

RUNPOTEC®

CABLE PULLING TOOLS



THE NEW

RP5



RUNPOTEC polyester
for pipe-Ø 16-40 mm

Integrated digital
meter counter - m/ft



INSTEAD OF € 202,00

€ **189,,-**

plus tax
RP5 - 30 m incl. meter counter,
RUNPOTEC Item no. 10203



Without meter counter

FROM
€ **140,,-**

plus tax
All prices and details about the new
RP5 in the catalog on page 22

GF3 SLIM Ø 4.5 MM



Glass Fiber Ø 3 mm
for pipe-Ø 5-50 mm



Integrated
digital meter
counter m/ft

INSTEAD OF € 197,00

€ **167,,-**

plus tax
GF3 SLIM - 30 m incl. meter counter,
RUNPOTEC Item no. 10208

XB500 T - Telescopic extension

Profi cable roller / loadable up to 800 kg



INSTEAD OF € 339,00

€ **310,,-**

plus tax
XB 500 T - Telescopic extension
RUNPOTEC Item no. 10187

XB500

ADAPTER PLATES

for XB 500 and XB 500 T



All prices and details about the new
adapter plates on page 12



KG
270

THE NEW



RP5

RUNPOTEC Polyester Ø 5,5 mm - 30 m

- RP5 - Cable pulling system Ø 5,5 mm - 30 m
- incl. digital meter counter - m/ft,
- 270 kg total breaking load
- triple twisted special polyester Ø 5,5 mm
- 2 x RG7 Guiding head incl. swivel Ø 7 mm - at the beginning and end
- Glide back protection
- Robust and shockproof storage box suitable for job sites
- Optimum field of application: pipe-Ø 16 mm – 40 mm

For more information see product videos.

INSTEAD OF € 202,00

€ **189,-**
plus tax

RP5 incl. meter counter - 30 m,
RUNPOTEC Item no. 10203



RP5

Integrated digital meter counter - m/ft



Almost break-free, even with the tightest radii



Triple twisted special polyester fish tape Ø 5,5 mm



50% less frictional resistance

Only punctual contact

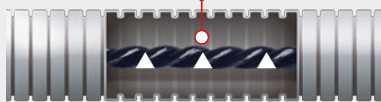

RP5 - RUNPOTEC Polyester without meter counter



FROM
€ **140,-**
plus tax

All prices and details about the new RP5 in the catalog on page 22



KG
100

INTRODUCTORY PRICE

GF3 SLIM - Glass Fiber Ø 3 mm - 30 m

- GF3 SLIM - cable pulling system incl. digital meter counter ft/m,
- fiber glass rod Ø 3 mm with RG4.5 - Guiding head with front thread (RTG Ø 3 mm) incl. swivel, 14 piece accessories
- easy service access – just open one screw, automatic guide back protection.
- Jobsite capable, splash water & dust proof
- Optimal field of application: pipe inner diameter Ø 5 mm – 50 mm

For more information see product videos.

For more information see product videos.

INSTEAD OF € 197,00

€ **167,-**
plus tax

GF3 SLIM - 30 m - Introductory price
RUNPOTEC Item no. 10208



GF3 SLIM



RG4.5 - Guiding head with front thread (RTG Ø 3 mm) incl. swivel

Integrated digital meter counter - m/ft



Accessory box (14-parts)





PROMOTION DESCRIPTION

XB 500 T (Telescop extension) Profi cable roller

Universal profi cable drum winder and unwinder for all types of cables and pipes (conductors, cable rings, cable drums - also damaged drums, conduits, ropes and cable drums).
 With closed lid Ø 500 mm | Load bearing capacity 800 kg
 With unfolded brackets Ø 800 mm | Filling height 390 mm
 Incl. 2 x RUNPOSTICKS 410 mm, X BOARD mandrel and clip system
 The height-adjustable lid is designed to secure loose cables or pipes, it prevents uncontrolled cable unwinding.

For more information see product video

INSTEAD OF € 339,00

€ 310,-
plus tax

XB 500 T - introductory price
 RUNPOTEC Item no. 10187



PROMOTION DESCRIPTION

XB 500 - Profi cable roller

Universal profi cable drum winder and unwinder for all types of cables and pipes (conductors, cable rings, cable drums - also damaged drums, conduits, ropes and cable drums).
 With closed lid Ø 500 mm | Load bearing capacity 800 kg
 With unfolded brackets Ø 655 mm | Filling height 260 mm
 incl. X BOARD mandrel and lateral clip system
 The height-adjustable cover is perfectly designed to secure loose cables, cable rings or pipes, thus preventing uncontrolled unwinding.

For more information see product videos.

INSTEAD OF € 255,00

€ 234,-
plus tax

XB 500 - promotional price
 RUNPOTEC Item no. 10136



XB 500 Castors - adapter plate

with 4 Castors incl. parking brake for XB 500 and XB 500 T. The adapter plate can be quickly connected using fixing brackets and quick-release levers. Thanks to the four castors incl. parking brake, the combination can be moved effortlessly.

Item no. 20401 Rec. trade price: 148,00 €



XB 500 Folding feet - adapter plate

with 4 fold-out feet for XB 500 and XB 500 T. The adapter plate can be quickly connected using fixing brackets and quick-release levers. The four fold-out feet enable a higher stand (21 cm) on the ceiling to be concreted.

Item no. 20957 Rec. trade price: 148,00 €





RG7 - Guiding head with front thread incl. swivel and kink protection

Integrated digital meter counter - m/ft



Accessory box (16-parts)



INTRODUCTORY PRICE

GF3 Glass Fiber Ø 3 mm - 30 m

GF3 - cable pulling system incl. digital meter counter ft/m, fiber glass rod Ø 3 mm with RG7 - Guiding head with front thread incl. swivel and kink protection, 16 piece accessories, easy service access - just open one screw, automatic guide back protection.

Jobsite capable, splash water & dust proof
Optimal field of application: pipe-Ø 10 mm - 50 mm

For more information see product videos.

INSTEAD OF € 199,00

€ **169,-**
plus tax

GF3 - 30 m - Introductory price
RUNPOTEC Item no. 10193



W-BOX | Sortimo COMPATIBLE

PROMOTION-DESCRIPTION

RUNPOSTICKS - Comfort-package + RC2 Inspection camera - 30 m

1 x RUNPOSTICKS - Comfort-package

Field of application: suspended ceilings, cable ducts, hollow walls, underfloor shafts usw... Content: 19-parts

1 x RC2 Inspection camera with 30 m cable

Memory function / documented evidence - photo, video
Battery operation up to 6 hours, protection class IP 67

For more information see product videos

INSTEAD OF € 705,00

€ **643,-**
plus tax

RC2 - 30 m - RUNPOSTICKS - offer
RUNPOTEC Item no. 11137



PROMOTION DESCRIPTION

RM35 Cable length measuring device + XB 300 Profi cable roller

1 x RM35 Digital cable length measuring device

incl. accessories and system case (incl. 2x mountingplate)

1 x XB 300 Profi cable roller

Universal cable drum rewinder and unwinder (also for damaged cable drums), loadable up to 300 kg

For more information see product videos.

INSTEAD OF € 463,40

€ **390,-**
plus tax

RM35 - XB 300 - offer
RUNPOTEC Item no. 11143



NEWS - SPECIAL OFFERS - INFORMATION	
RP5 - Profi cable pulling system Ø 5,5 mm GF3 SLIM - Glass Fiber Ø 3 mm	2
XB 500 T Telescopic extension XB 500 XB 500 Adapter plate - Castors / Folding feet	3
GF3 - Glass Fiber Ø 3 mm	4
RC2 Inspection camera + RUNPOSTICKS - Comfort package	4
RM35 Digital cable length measuring device + XB 300 Profi cable roller	4
RUNPOSTICKS - Comfort package + Cable pulling loop - hook	62
RP5 - Profi cable pulling system Ø 5,5 mm + Cable pulling loop - thread	62
GF3 Glass Fiber Ø 3 mm + RC2 Inspection camera	63
GF4.5 Fiberglass rod Ø 4,5 mm + RC2 Inspection camera	63
CABLE PULLING SYSTEMS	
Cable lubricant GEL FOAM SPRAY LIQUID	17
RP5 - Profi cable pulling system Ø 5,5 mm	22
RUNPOSTICKS - Standard- and comfort package	24
RP1 Cable pulling rod Ø 4 mm	21
GF3 Glass Fiber Ø 3 mm - Cable pulling system	26
GF3 SLIM Glass Fiber Ø 3 mm - Cable pulling system	28
RT 2008 - Mechanical cable pulling tool	30
MET4 - Steel fish tape Ø 4 mm	31
Cable pulling loop - hook (quick connection) RTG 6 thread	32
Cable pulling grip - RTG Ø 6 mm thread loop	33
Cable diameters - Summary table - Information page	35
GF4.5 Fiberglass rod Ø 4,5 mm - Cable pulling system	36
GF6 Fiberglass rod Ø 6 mm - Cable pulling system	39
GF7.5 GF9 Fiberglass rod Ø 7,5 / 9 mm - Cable pulling system	43
GF11 Fiberglass rod Ø 11 mm - Cable pulling system	46
GF15 Fiberglass rod Ø 15 mm - Cable pulling system	48
Flexible leading head-set	42
CW 800 E - Capstan winch for horizontal cable pulling	50
Polyester cable pulling rope - incl. steel reel or drum	52
Cable guide roller	53
Metal spiral - Ø 4 mm Nylon fish tape - Ø 3 – 4 mm	56
INSPECTION SYSTEMS - MEASURING DEVICES - RUNPOTEC SYSTEM-CASE	
RC2 - Inspection camera	18
RM35 - Digital cable length measuring device	6
RM80 - Laser distance meter	55
RUNPOTEC system case	54
CABLE ROLLER SYSTEMS	
XB 300 - Profi cable roller Multifunction mandrel	8
XB 500 - Profi cable roller	10
XB 500 T (Telescopic extension) - Profi cable roller	11
XB 500 Adapter plate - Castors Folding feet	12
PRO 530 PRO 670 - Cable drum roller	13
AS 900 - Roll-off rails	16
RUNPOLIFTER 4500 SET - Cable drum lifter	14
Drum samples - for RUNPOLIFTER 4500 SET - Information page	15
Cable guide roller	53
PRICE LIST - QUALITY CHECK	
Price list	57
Quality check	63

RM35 Digital cable length measuring device



CALIBRATABLE



Foldable



Jobsite capable:
Splash water & dust proof,
shock- and break-proof

Versatile use with cables,
single conductors, ropes,
pipes of Ø 2 mm – 32 mm

Compatible with all unwinding
systems

Battery life in continuous
operation 100 hrs. (without
backlighting)

RUNPOTEC system case



W-BOX | Sortimo COMPATIBLE

The **RM35** is a digital cable length measuring device with which cables, single wires, ropes, pipes or hoses with a diameter of Ø 2 mm to Ø 32 mm can be measured precisely. It is splash-proof and dust-proof, extremely shock-resistant and therefore ideally suited for the construction site. The RM35 accessories included are stowed away in the RUNPOTEC system case, which is compatible with Sortimo. The strap with clip system makes it easy to connect RM35 to the X BOARD XB 300 or XB 500 cable unwinding system. If the belt is connected to the anchor pad with a clip system, the RM35 is compatible with all conventional unwinding systems.

Display with extensive application possibilities

- 1 Current counter value (pos./neg.), max. measuring distance 99999,99 m
- 2 Countdown, e.g. for repeated cable cutting or drum residual value determination (initial value 200 m minus unwound length 50 m 1 results in current residual value (150 m) – see actual 3)
- 3 Actual - current remaining value (150 m) from the entered countdown value
- 4 Add current counts (positive/negative) to totals (TOTAL 1/2).
- 5 Cable pull direction display (forward/backward)

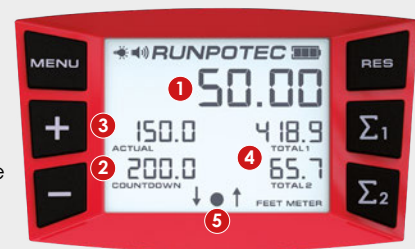

Scope of delivery – RM35 including extensive accessories (Item no. 10172, 10184, 11143)

- A RM35 Digital cable length measuring device
- B RUNPOTEC system case with case insert for RM35
- C Mountingplate RM35
- D Mountingplate system case
- E Belt with clip system
- F Connecting pad
- G Multi jaws RM35 – round
- H Guide jaws RM35
- I USB-C charger cable



Application examples









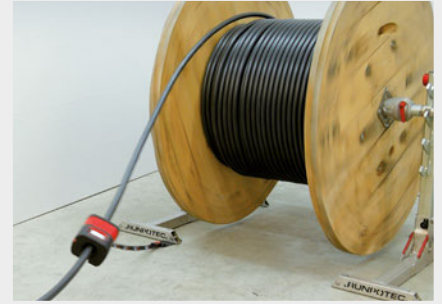





RM35 with belt and clip system connected to GF4.5 fiberglass rod

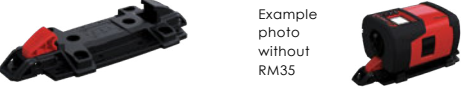

RM35 with belt and clip system connected to XB 500

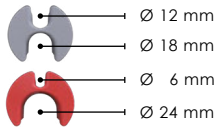

RM35 with RUNPOLIFTER L1600 and 3 x 35 mm² cable

Item	Item no.	Rec. trade price
	10172	390,90 € 349,00 € <i>Introductory price</i>
 <p>CALIBRATED</p> <p>Description of the calibration</p>	10184	 489,00 €
	20706 20714	34,00 € 39,10 €
 <p>Info: Easy changing with 2,5 mm Allen key</p>	20707	13,40 €
 <p>Example photo: Interior view</p>	20708	56,00 €
 <p>Example photo: Without RM35 and system case</p>	20739	40,20 €
 <p>Example photo without RM35</p>	20849	20,50 €
  <p>Ø 12 mm Ø 18 mm Ø 6 mm Ø 24 mm</p>	20738	17,50 €
  <p>from Ø 2 mm – Ø 15 mm adjustable</p>	20850	22,70 €
  <p>Width from 3 mm – 15 mm adjustable</p>	20851	22,70 €

XB 300 Profi cable roller

VIDEO



XB 300 MANDREL



X BOARD MANDREL
Ø 45 mm, removable
for small drums

Now with clip system for
the RM 35 digital cable
length measuring device









RM35 Digital cable length measuring device COMPATIBLE

The compact **XB 300** is a universal, professional device for winding in/out cables on all small- to mid-sized cable drums and particularly well suited for damaged cable drums. The XB 300 scores with its small, light and flat design, has a diameter of Ø 300 mm and can be loaded up to 300 kg. Six rubberised feet ensure a non-slip and secure standing position. The removable mandrel allows cable drums with different hole sizes to be used. Here also the multifunction mandrel can be attached to unwind loose cable bundles or single wires. For trouble-free and efficient working without the tangled cables. (Multifunction mandrel is not included).

Compatible with the Multifunction mandrel



Possible applications



Multifunction mandrel

Can only be used in combination with XB 300 (XB 500, XB 500 T)

VIDEO





XB 300 MANDREL



Telescopic middle mandrel height up to max. 294 mm and a diameter of Ø 72.5 mm

Diameter with unfolded side brackets Ø 430 mm



foldable

The **multifunction mandrel** has been specially developed for the XB 300, XB 500 and XB 500 T cable rolling systems. By attaching it to the stainless steel central mandrel and unfolding the 4 side brackets, loose cable bundles or individual wires can also be rolled. Optimum area of application: rolling of loose cable bundles or individual wires up to a max. height of 294 mm and a max. diameter of 430 mm

Possible applications



Item		Item no.	Rec. trade price
	XB 300 Profi cable roller Ø 300 mm load bearing capacity 300 kg incl. X BOARD mandrel and lateral clip system (for connection with RM35 Cable length measuring device)	10137	114,40 €
	Multifunction mandrel Can only be used in combination with XB 300, XB 500 and XB 500 T	20696	55,00 €
	X BOARD mandrel for XB 300, XB 500 and XB 500 T	20632	10,30 €



Application examples

OFFER DESCRIPTION

XB 300 + multifunction mandrel-set

INSTEAD OF € 169,40

plus VAT.

€ 152,-

XB 300 - multifunction mandrel-set - offer
RUNPOTEC item no. 10174



W-BOX | **Sortimo** COMPATIBLE

OFFER DESCRIPTION

XB 300 – complete-set incl.
multifunction mandrel + system case

INSTEAD OF € 225,40

plus VAT.

€ 195,-

XB 300 - complete-set - offer
RUNPOTEC item no. 10170



W-BOX | **Sortimo** COMPATIBLE

OFFER DESCRIPTION

RP5 + XB 300 – multi-set incl.
multifunction mandrel + system case

1 x RP5 without meter counter - 30 m, triple twisted,
total breaking load 270 kg

1 x XB 300 - incl. multifunction mandrel

The multifunction mandrel has been specially
developed for the XB 300, XB 500 and
XB 500 T cable rolling systems

INSTEAD OF € 387,40

plus VAT.

€ 314,-

RP5 - 30 m - XB 300 - multi-set - offer
RUNPOTEC item no. 10171

VIDEO 



RUNPO 5

XB 500 Profi cable roller

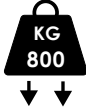

X BOARD MANDREL
Ø 45 mm, removable
for small drums

Lid height adjustable, removable
and reversible 180°

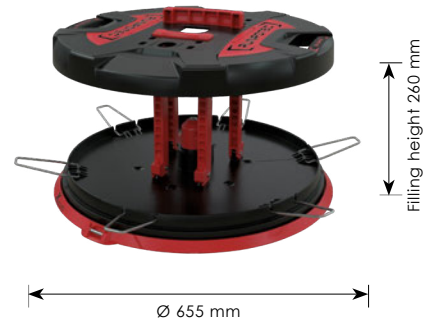

Possible applications







With clip system for
attaching to the RM35
digital cable length
measuring device

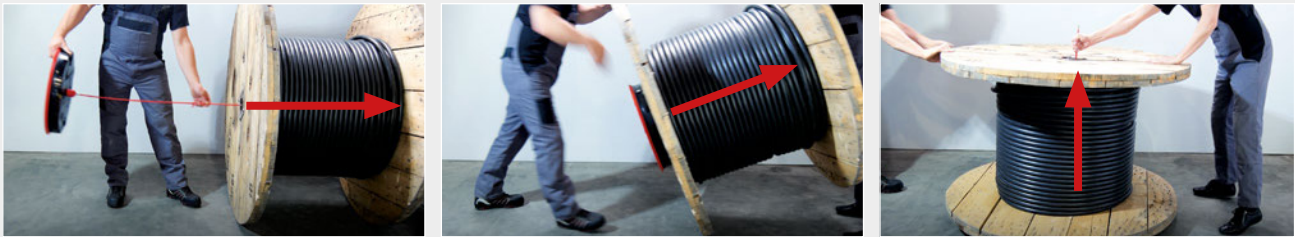

The **XB 500** is a universal professional cable drum winder and unwinder for all types of cables and pipes (conductors, cable rings, cable drums, conduits, ropes and cable drums). It enables trouble-free and rational working without tangled cables. The XB 500 has a diameter of Ø 500 mm and can be loaded up to 800 kg and is suitable for almost every type of drum, especially for damaged cable drums. 12 rubberised feet ensure a non-slip and stable base. The height-adjustable cover is perfectly designed to secure loose cables, cable rings or pipes in the XB 500, thus preventing uncontrolled cable unwinding.

Possible applications in combination with the RUNPOSTICKS push rod set (XB 500 T, XB 500 and XB 300)



Item		Item no.	Rec. trade price
	XB 500 Profi cable roller, Ø 500 mm load bearing capacity 800 kg, drum width variable, incl. X BOARD mandrel and lateral clip system (for connection with RM35 Cable length measuring device), the RUNPOSTICKS (item no. 20881) can be retrofitted and stored in the lid	10136	255,00 € Promotional price 234,00 €
 	RUNPOSTICKS red (hard) Ø 7,5 mm, 2 x 410 mm stainless steel, RTG Ø 6 mm thread (Can be stored in the lid of the XB 500 and XB 500 T)	20881	16,00 €
	X BOARD mandrel for XB 500 T, XB 500 and XB 300	20632	10,30 €

All prices are ex-works 5303 - Thalgau - AUSTRIA - plus statutory taxes and duties. All price information represents non-binding price recommendations. Pricelist 2024. All illustrations are symbol photos. Typing and printing errors reserved.

XB 500 T (Telescopic extension) Profi cable roller



Possible applications



With clip system for attaching to the RM35 Digital cable length measuring device



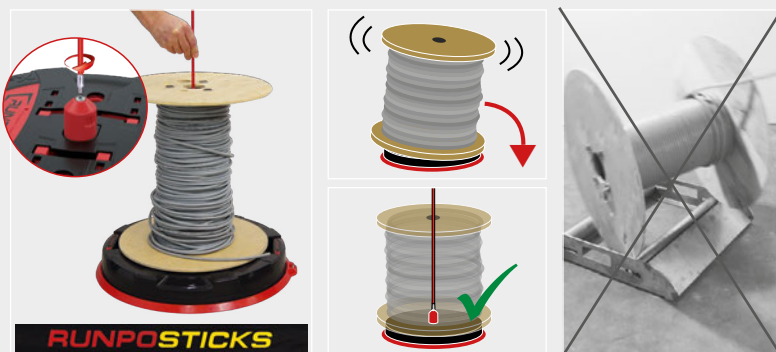

The compact **XB 500 T** (telescopic extension) is a universal professional cable drum reel and unwinder for all types of cables and pipes (core cables, cable rings, cable drums, empty pipes, ropes and cable drums). It enables trouble-free and efficient work without tangled cables. The XB 500 T (telescopic extension) can hold up to 800 kg and fits almost every type of drum. Especially suitable for damaged cable drums. The height-adjustable lid can be adjusted up to a filling height of 390 mm, making it perfectly designed to secure loose cables, cable rings or pipes in the XB 500 T. This prevents uncontrolled cable unwinding. The 6 fold-out support extensions can be extended up to Ø 800 mm using the telescopic extensions. The RUNPOSTICKS (2 x 410 mm, Ø 7.5 mm) stored in the lid can be screwed onto the thread of the stainless steel center mandrel and thereby prevent smaller or lighter drums from slipping down. 12 rubberized feet ensure a non-slip and secure stand.

The drum can be prevented from falling by screwing the RUNPOSTICKS push rods onto the XB 500 T, XB 500, XB 300.

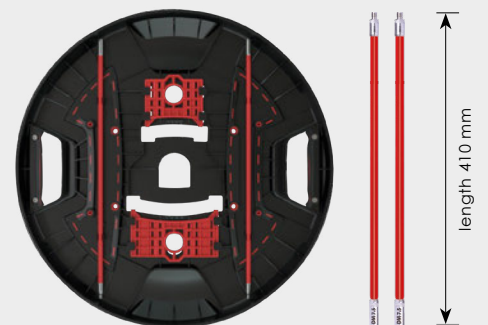

The RUNPOSTICKS push rods Ø 7,5 mm, length 410 mm, are stored in the lid



Item		Item no.	Rec. trade price
	<p>XB 500 T (Telescopic extension) Profi cable roller with a closed lid Ø 500 mm load bearing capacity 800 kg with unfolded brackets Ø 800 mm filling height 390 mm incl. 2x RUNPOSTICKS 410 mm, X BOARD mandrel and clip system</p>	10187	339,00 €
		Promotional price	310,00 €

XB 500 CASTORS - ADAPTER PLATE with 4 transport rollers



VIDEO
XB 500
CASTORS



KG
80



Quick release and fixing brackets

4 transport rollers incl. parking brake

The **XB 500 castor adapter plate** can be connected to the XB 500 or XB 500 T professional cable roller. Ideal for unwinding and rolling up pipe or cable bundles or cable drums. The adapter plate can be quickly connected using fixing brackets and quick-release levers. Thanks to the 4 transport rollers including a parking brake, the combination can be moved or fixed effortlessly. In this combination, the XB 500 and XB 500 T can hold up to 80 kg.

Connection with XB 500 / XB 500 T



Symbol photo without XB 500 / XB 500 T

Application example



Item	Item no.	Rec. trade price
 <p>XB 500 castors - adapter plate with 4 transport wheels including parking brake for XB 500 and XB 500 T</p>	20401	148,00 €

XB 500 FOLDING FEET - ADAPTER PLATE with 4 folding feet



VIDEO
XB 500
FOLDING FEET



KG
80



Quick release and fixing brackets

Four fold-out feet



34 mm

The **XB 500 folding feet - adapter plate** can be connected to the XB 500 or XB 500 T professional cable roller. Ideal for unwinding and rolling up pipe or cable bundles or cable drums on steel-laminated concrete ceilings during the construction phase. The adapter plate can be quickly connected using fixing brackets and quick-release levers. The four fold-out feet enable a higher stand (21 cm) on the ceiling to be concreted. In this combination, the XB 500 and XB500 T can hold up to 80 kg.

Connection with XB 500/XB 500 T



Symbol photo without XB 500 / XB 500 T

Application example



Item	Item no.	Rec. trade price
 <p>XB 500 Folding feet - adapter plate with 4 fold-out feet for XB 500 and XB 500 T</p>	20957	148,00 €

All prices are ex-works 5303 - Thalgau - AUSTRIA - plus statutory taxes and duties. All price information represents non-binding price recommendations. Pricelist 2024. All illustrations are symbol photos. Typing and printing errors reserved.

PRO 530 | PRO 670 Cable drum roller

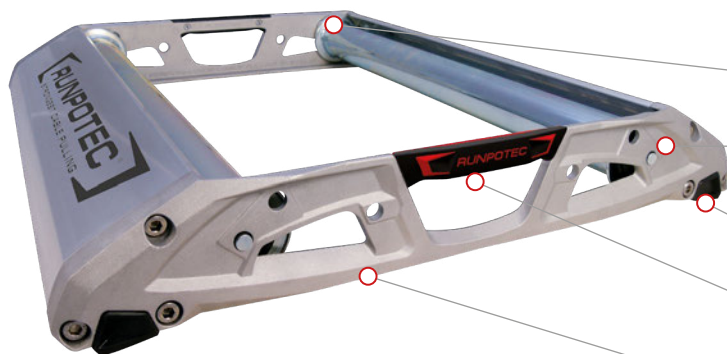

- Completely pre-assembled
- Extra strong bearings and welded belt edges
- Adjustable support rollers
- Compact feet - stable, non-slip base
- Rubberized carrying handles
- Light and solid aluminium die casting and continuous casting

The cable drum unwinder made of light die-cast aluminum and continuous casting with robust, adjustable support rollers is ideal for the highest loads in daily use. The support rollers with spring core axles can be quickly adapted to different cable drum sizes up to a maximum of \varnothing 1000 mm by adjusting the spacing to 85, 160, 225, 290, 310 and 335 mm. The closed, maintenance-free drum bearings are equipped with welded belt edges and extra strong ball bearings. Four feet made of high-quality plastic ensure a stable and non-slip stand and protect finished floor coverings. PRO 530 and PRO 670 cable drum unwinders can be retrofitted with castors!

Different cable drum sizes up to max. \varnothing 1000 mm







Castors can be retrofitted



Extra strong bearings and welded belt edges



Item		Item no.	Rec. trade price
	Cable drum roller pre-assembled, incl. support rollers load bearing capacity 215 kg		
	PRO 530 - max. drum width 530 mm	10134	199,00 €
	PRO 670 - max. drum width 670 mm	10135	230,00 €
	Castors in a 4-part-set 4 pieces with parking brakes PU = 4 x castors incl. mounting screws (M10)	20623	75,00 €
	Support roller 530 for cable drum roller PRO 530 roller length 530 mm	20609	29,90 €
	Support roller 670 for cable drum roller PRO 670 roller length 670 mm	20610	31,90 €

RUNPOLIFTER 4500 SET Cable drum lifter







Foldable
Compact – easy transportation
Only 22 kg per lifting support



The **RUNPOLIFTER 4500** is a foldable cable drum lifter that is capable of lifting drums with a maximum diameter of 1600 mm and a maximum weight of 4500 kg and a max. width of 1250 mm. The two included centring cones each have a quick-fastener. Drums with a central hole up to Ø 115 mm can be fixed.

Scope of delivery:
1 x Lifting support right
1 x Lifting support left
1 x Drum shaft
2 x Centring cones

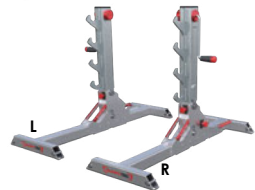

Item	Lifter Sets	Shaft length	Item no.	Rec. trade price
 <p>RUNPOLIFTER 4500 SET 1 x Lifting support right 1 x Lifting support left 1 x Drum shaft 2 x Centring cones stainless steel, galvanised steel</p>	Lifter 1150 Lifter 1350 Lifter 1600	1150 mm 1350 mm 1600 mm	10162 10163 10164	2688,00 € 2730,00 € 2771,00 €
 <p>Drum shaft Ø 54 mm High strength hollow shaft, integrated heavy duty plain bearing, stainless steel security mount, high weight saving</p> <p>Length 1150 mm – 11,00 kg - lifting capacity 4.500 kg Length 1350 mm – 12,50 kg - lifting capacity 4.500 kg Length 1600 mm – 14,30 kg - lifting capacity 4.500 kg Special lengths possible on request</p>			20692 20693 20694 20690	519,00 € 562,00 € 606,00 € Price o. r.
 <p>Centring cones (2 pieces) with quick-release fastener drum central hole up to Ø 115 mm</p>			10147	139,00 €
 <p>Lifter transport wheels 4 wheels including mounting screws (optionally retrofittable)</p>			20711	139,00 €
 <p>Lifting supports – RUNPOLIFTER 4500 1 x lifting support right + 1 x lifting support left stainless steel, galvanised steel</p>			10161	2153,00 €

All prices are ex-works 5303 - Thalgau - AUSTRIA - plus statutory taxes and duties. All price information represents non-binding price recommendations. Pricelist 2024. All illustrations are symbol photos. Typing and printing errors reserved.

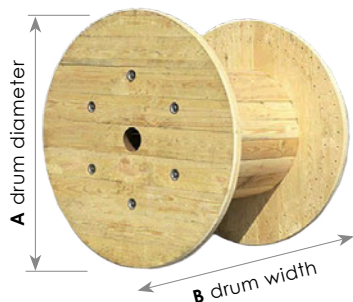

Application examples: Drum shaft lengths for suitable drum widths

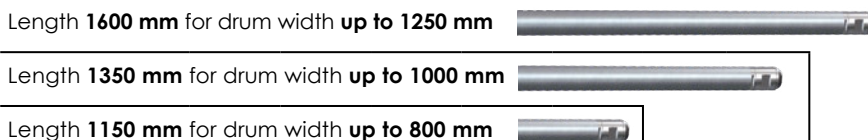

A drum diameter mm	610	710	810	910	1010	1210	1410	1610	1810
B drum width mm	490	520	520	690	710	890	890	1100	1100

cable diameter mm **Cable lengths in m on a drum**

	6	1113	2024	2755						
CAT5/6/7	7	845	1481	2340						
Coaxial	8	637	1064	1463	2731					
3 x 1,5 mm ²	9	472	892	1152	2202	2866				
3 x 2,5 mm ²	10	386	677	980	1768	2349				
5 x 2,5 mm ²	11	314	564	761	1404	1912				
1 x 25 mm ²	12	253	468	643	1206	1540				
	13	237	385	542	1032	1339	2727			
1 x 35 mm ²	14		364	454	881	1159	2265	2967		
7 x 2,5 mm ²	15		297	430	749	1000	1991	2479		
1 x 50 mm ²	16		239	358	632	860	1756	2205		
5 x 6 mm ²	17		226	294	603	736	1545	1959		
1 x 95 mm ²	18		218	281	505	705	1355	1737		
3 x 16 mm ²	19		172	228	485	599	1184	1535	2722	
10 x 2,5mm ²	20		165	219	402	576	1139	1352	2435	2831
5 x 10 mm ²	21		159	211	387	485	991	1304	2172	2527
4 x 16 mm ²	22		122	167	315	468	856	1145	1931	2248
	23		117	161	304	389	827	999	1869	2172
5 x 16 mm ²	24		113	156	294	377	709	967	1657	1927
1 x 185 mm ²	25		110	151	285	365	688	639	1608	1867
3 x 35 mm ²	26		80	116	226	299	668	814	1419	1650
3 x 50 mm ²	27		78	113	221	290	567	700	1244	1450
1 x 240 mm ²	28		76	109	215	282	551	681	1211	1409
24 x 2,5 mm ²	29		73	106	209	226	462	663	1180	1371
5 x 35 mm ²	30		71	103	162	220	450	564	1028	1197
4 x 50 mm ²	31			76	157	214	438	550	1003	1166
1 x 300 mm ²	32			74	153	209	428	537	866	1009
40 x 2,5 mm ²	33			72	150	204	352	451	846	985
	34				146	158	344	441	828	962
3 x 95 mm ²	35				108	154	336	431	707	824
5 x 50 mm ²	36				105	151	329	422	692	806
4 x 70 mm ²	37				103	148	265	348	678	788
3 x 120 mm ²	38					144	259	341	664	772
	39					107	254	334	560	653
4 x 95 mm ²	40					105	249	327	549	640
5 x 70 mm ²	41					102	244	264	539	627
3 x 150 mm ²	42					100	190	259	529	615
4 x 120 mm ²	43						187	254	437	511
	44						183	249	430	502
	45						180	245	422	492
5 x 95 mm ²	46						177	240	415	484
3 x 185 mm ²	47						174	187	408	475
	48						129	184	330	385
4 x 120 mm ²	49						127	181	325	380
5 x 120 mm ²	50						125	178	319	373
	51						123	175	314	367
3 x 240 mm ²	52						121	172	310	361
	53							170	305	356
4 x 185 mm ²	54							126	230	280
	55							124	235	276
	56							122	232	271
	57							121	228	267
	58							119	225	263
5 x 150 mm ²	59							117	222	260
3 x 240 mm ²	60								219	256
	61								216	252



The cable examples shown correspond to the load capacity of the RUNPOLIFTER (less than 4500 kg). Source: Leading cable dealers. All information are non-binding.

AS 900 Roll-off rails



The **AS 900** unwinding rails are designed for safe unwinding of heavy cable material and cable drums from 450 mm to 2000 mm diameter. One of the two heavy duty rollers can be positioned in 3 different settings. The stable stainless steel-aluminium construction with high-quality, maintenance-free, ball bearing heavy-duty support rollers ensure a long service life. Easy and quick change of drums due to the unwinding brake. Due to their two-part narrow design they are easy to use in cramped spaces. Especially recommended where different cable types are to be processed side by side within a short time. Since some of the drums are in very poor condition, the recommended working load bearing capacity of 800 kg should not be exceeded.

Roll-off brake function

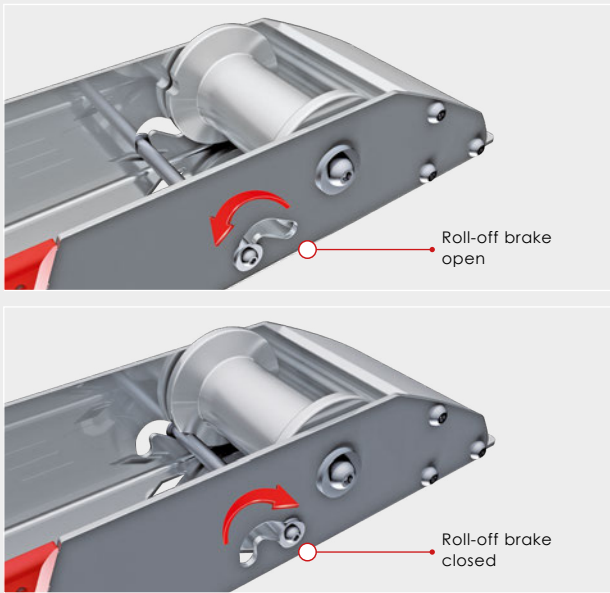



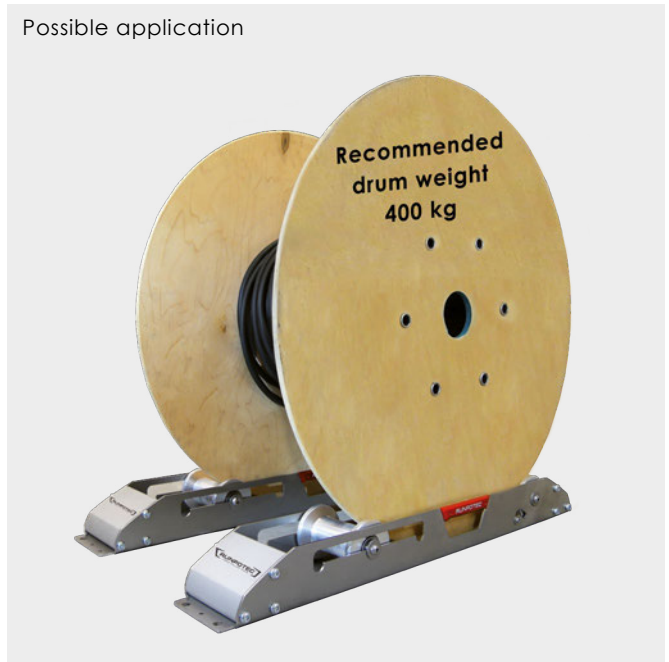

Possible application



Item	Item no.	Rec. trade price
<p>AS 900 Roll-off rails-set, 2 pieces Maximum load on the rollers: 1700 kg Recommended drum weight: 400 kg (depending on the condition of the wooden drum) Dimensions: L 935 mm W 345 mm H 165mm Weight: 23,03 kg stainless steel-aluminium construction</p>	10142	864,00 €

All prices are ex-works 5303 - Thalgau - AUSTRIA - plus statutory taxes and duties. All price information represents non-binding price recommendations. Pricelist 2024. All illustrations are symbol photos. Typing and printing errors reserved.

Item	Item no.	Rec. trade price
 <p>NON-INFLAMMABLE</p> <p>Cable lubricant GEL 1000 g</p> <p>Not flammable Friction-reducing, improved gliding property, non-corrosive, heat-resistant up to 85°C/185°F, non-stick and non-staining, gentle on skin, biodegradable.</p> <p>Tip: Ask for the package price (box: 8 pieces)</p>	30064	8,90 €
 <p>NON-INFLAMMABLE</p> <p>Cable lubricant GEL 250 g</p> <p>Not flammable Friction-reducing, improved gliding property, non-corrosive, heat-resistant up to 85°C/185°F, non-stick and non-staining, gentle on skin, biodegradable.</p> <p>Tip: Ask for the package price (box: 24 pieces)</p>	30467	4,40 €
 <p>NON-INFLAMMABLE</p> <p>Cable lubricant SPRAY 400 ml</p> <p>Special attachment – spray large areas or open the tube for precise streams.</p> <p>Not flammable Excellent lubrication, non-stick, non-drying, colourless, odourless.</p> <p>Tip: Ask for the package price (box: 12 pieces)</p>	20523	8,20 €
 <p>NON-INFLAMMABLE</p> <p>Cable lubricant FOAM 400 ml</p> <p>Special attachment – spray large areas or open the tube for precise streams.</p> <p>Not flammable Excellent lubrication, water-soluble, non-stick, non-drying, VOC-free.</p> <p>Tip: Ask for the package price (box: 12 pieces)</p>	20522	7,10 €
 <p>Cable lubricant LIQUID 1000 ml</p> <p>Friction-reducing, non-stick and non-staining, colour- and odourless, water soluble</p> <p>Tip: Ask for the package price (box: 15 pieces)</p>	30063	7,40 €

RC2 Inspection camera

RC2 Inspection camera with 6 integrated LED (camera probe protection rating IP67), enclosed in robust stainless steel head (Ø 13 mm) with RTG Ø 6 mm inside connecting thread – compatible to all RUNPOTEC products with RTG Ø 6 mm thread. ATTENTION: Compatible only with RUNPOTEC cable pulling systems! Preservation of evidence, storage function photo, video and audio documentation! Battery operation up to 6 hours. Areas of application: Pipe inspections over long distances of up to 50 m. Suitable for pipes with an inner diameter of 14 mm or more, but also for larger pipe cross-sections (ventilation systems, drainage systems, waste water pipes, etc.).

* Extensive accessories included

- A** RG7 - Guiding head with front thread
- B** Systemglider RC2
- C** High-performance 320-lumen rechargeable LED lamp (Rechargeable via USB-C charging socket)
- D** USB / USB-C charging cable 1,5 m
- E** USB EURO power plug 230 V
- F** Micro memory card 8 GB / adapter
- G** Magnet fishing-set
- H** Fishing hook (Stainless steel)
- I** RC2 thread attachment
- J** Flexible attachment 12 cm
- K** Connection thread-set, RTG Ø 6 mm



Item		Length	Item no.	Rec. trade price
	RC 2 Inspection camera	10 m	10139	524,00 €
	with cable on reel and monitor	30 m	10140	566,00 €
	in the RUNPOTEC system case	50 m	10141	608,00 €
	* Included accessories, see above			

All prices are ex-works 5303 - Thalgau - AUSTRIA - plus statutory taxes and duties. All price information represents non-binding price recommendations. Pricelist 2024. All illustrations are symbol photos. Typing and printing errors reserved.

Application examples with RUNPOTEC cable pulling systems



Pipe inspection for large pipe diameters



Pipe inspection from Ø 14 mm and more



Protection rating IP67 waterproof



Ventilation inspection and servicing



Cavity wall inspection, locating and capturing



Shafts and underfloor ducting

30m



30m



SPECIAL OFFER

1 x GF3 Glass Fiber Ø 3 mm – 30 m, incl. meter counter, description p. 26
1 x RC2 Inspection camera with 30 m cable

INSTEAD OF € 725,00

€ 659,-

plus VAT.

RC2 - 30 m - GF3 - 30 m – offer
RUNPOTEC item no. 11146



30m



SPECIAL OFFER

1 x RUNPOSTICKS comfort-package, description p. 24
1 x RC2 Inspection camera with 30 m cable

INSTEAD OF € 705,00

€ 643,-

plus VAT.

RUNPOSTICKS – RC2 - 30 m – offer
RUNPOTEC item no. 11137

50m



50m



SPECIAL OFFER













1 x GF4.5 Fiberglass Ø 4,5 mm – Profi-Set 50 m, incl. steel reel, description p. 36
1 x RC2 Inspection camera with 50 m cable

INSTEAD OF € 923,00

€ 789,-

plus VAT.

GF4.5 - 50 m – RC2 - 50 m – offer
RUNPOTEC item no. 11140

Item	Item no.	Rec. trade price
 <p>1 2</p>	<p>Camera probe RC 2 with cable on spool incl. camera reel 1 Ø 13 mm IP 67 RTG Ø6 mm 10 m 30 m 50 m</p> <p>Camera reel RC 2 – empty 2</p>	<p>20593 214,00 € 20560 300,00 € 20559 345,00 € 20608 29,90 €</p>
 <p>Detail: USB-C charging socket</p>	<p>High-performance rechargeable LED-lamp 320 lumen, USB-C charging socket (incl. Li-ion battery), protection rating IP67 2 x RTG Ø 6 mm thread (1 x vertical and 1 x horizontal)</p>	<p>20485 47,40 €</p>
	<p>Systemglider RC2 L 130 mm W 58 mm H 53 mm RTG Ø 6 mm front thread</p>	<p>20606 22,10 €</p>
 <p>STAINLESS STEEL</p>	<p>RG7 - Guiding head with front thread incl. swivel , stainless steel, RTG Ø 6 mm thread</p>	<p>20460 29,00 €</p>
	<p>Endoscope camera probe flexible 0,8 m Ø 9 mm for RC2 Inspection camera 300.000 Pixel (720 x 576), Fild of view 64°, protection rating IP 67, 4 x LED (dimnable)</p>	<p>20481 69,00 €</p>
 <p>Extra slim Ø 3,9 mm</p>	<p>Endoscope camera probe flexible 1 m Ø 3,9 mm for RC2 Inspection camera 100.000 Pixel (320 x 240), Fild of view 54°, IP 67 2 x LED (dimnable)</p>	<p>20488 141,00 €</p>
	<p>Thread attachment RC2 L 101 mm W 16 mm H 19 mm RTG Ø 6 mm front thread</p>	<p>20607 17,00 €</p>
	<p>Micro memory card 8 GB, class 6 incl. adapter and storage case</p>	<p>20483 6,80 €</p>
	<p>Magnet fishing-set 1,5 – 2,9 kg (pipe Ø 16 – 40 mm)</p>	<p>20475 23,70 €</p>
	<p>Connection thread-set Set of 3 (1 x inside, 1 x outside, 1 x blindcap) RTG Ø 6 mm thread</p>	<p>20484 9,60 €</p>
 <p>1 2</p>	<p>Functionglider with RTG Ø 6 mm 1</p> <p>Stainless steel fishing hook with RTG Ø 6 mm 2</p>	<p>20468 20,60 € 20261 7,00 €</p>
 <p>STAINLESS STEEL</p>	<p>Attachment flexible 12 cm stainless steel, RTG Ø 6 mm thread</p>	<p>20509 8,00 €</p>
	<p>RUNPOTEC system case with case insert for RC2 Inspection camera</p>	<p>20612 56,00 €</p>

All prices are ex-works 5303 - Thalgau - AUSTRIA - plus statutory taxes and duties. All price information represents non-binding price recommendations. Pricelist 2024. All illustrations are symbol photos. Typing and printing errors reserved.

RP1 Cable pulling rod Ø 4 mm



KG
170

Beginning: RG6 - Guiding head with special eyelet Ø 6 mm, pressed onto strand

Ending: Eyelet Ø 6 mm, RTG Ø 6 mm thread, screwed to strand

RP1 is not suitable for RT 2008!

RC2 - Inspection camera COMPATIBLE





Attention!
electric
conductive

RP1, special plastic fish tape Ø 4 mm. Special eyelet: 1 x RG6 - Guiding head with special eyelet. Excellent bending and gliding behavior, large eyelet with hole up to 7 x 2.5 mm² cable, perfect fabrication, no hems and high breaking load. Ending: with screwable eyelet with RTG Ø 6 mm thread. Optimal pipe diameters: Tube Ø 16, 25 and 32 mm

Rod	Rec. pipe diameter	Bending radius rod	TBL - ending	Total breaking load - beginning
Ø				
4 mm	13 - 25 mm	15 mm	170 KG	170 kg

Item	Length	Item no.	Rec. trade price
	5 m	30027	17,10 €
	10 m	30028	18,40 €
	15 m	30029	22,10 €
	20 m	30030	25,80 €
	25 m	30042	30,50 €
	30 m	30043	35,30 €

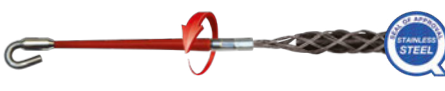
ACCESSORIES – useful in combination with RP1

Item	Ø	Item no.	Rec. trade price
 <p>Cable pulling grip with quick-release fastener incl. swivel stainless steel</p>	4 – 6 mm	20272	26,80 €
	6 – 9 mm	20273	29,90 €
	9 – 15 mm	20274	34,00 €
 <p>Application: Quick-release fastener compatible with RG - RUNPOGLIDER guiding head</p>			
 <p>Eyelet-set Ø 7 mm, stainless steel RTG Ø 6 mm thread, PU = 3 pieces</p>	7 mm	20487	9,40 €

RP5 RUNPOTEC Polyester Ø 5,5 mm – Profi cable pulling system

VIDEO



RP5

KG 270

Triple twisted

PATENTED



Integrated digital meter counter – m/ft



RG7 - Guiding head with swivel Ø 7 mm

Glide back protection

Active

Triple twisted special polyester fish tape Ø 5,5 mm

Beginning: RG7 - Guiding head incl. swivel Ø 7 mm, pressed onto strand

Ending: RG7 - Guiding head incl. swivel Ø 7 mm, pressed onto strand

Attention!
electric conductive

Integrated digital meter counter – m/ft



3 years without battery change (with average use)

Virtually break-free even with tightest radii



R

Very narrow bending radius

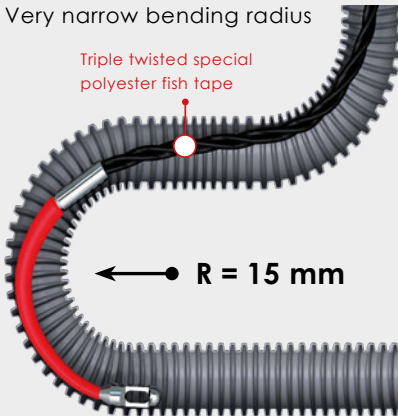

Triple twisted special polyester fish tape

R = 15 mm

50 % less friction resistance

Only punctual contact





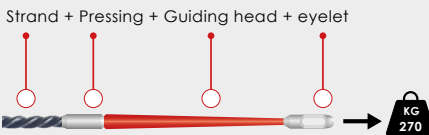

Total breaking load 270 Kg

Strand + Pressing + Guiding head + eyelet

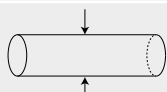







KG 270

Rod	Rec. pipe diameter	bending radius	Total breaking load incl. RG7 - RUNPOGLIDER
Ø			
5,5 mm	16 – 40 mm	15 mm	270 kg

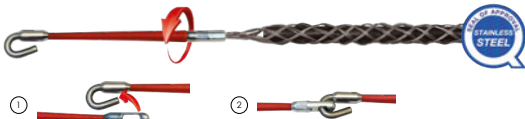
Item	Length	Item no.	Rec. trade price
	20 m	10202	170,00 €
	30 m	10203	202,00 €
	Introductory price		
	20 m	10013	140,00 €
	30 m	10014	162,00 €

All prices are ex-works 5303 - Thalgau - AUSTRIA - plus statutory taxes and duties. All price information represents non-binding price recommendations. Pricelist 2024. All illustrations are symbol photos. Typing and printing errors reserved.

Item		Item no.	Rec. trade price
	RP5 replacement fish tape Ø 5,5 mm 2 x RG7 - Guiding head incl. swivel triple twisted special plastic tape total breaking load 270 kg 20 m 30 m 40 m	20240 20241 20242	110,00 € 126,00 € 144,00 €
	RUNPOTEC system case with UNIVERSAL case insert	20613	56,00 €
	RP5 - empty box for replacement fish tape RP5 20 m or 30 meter	30146	36,10 €
 ①  ② 	Cable pulling grip with quick-release fastener incl. swivel, stainless steel Ø 4 - 6 mm Ø 6 - 9 mm Ø 9 - 15 mm	20272 20273 20274	26,80 € 29,90 € 34,00 €
 Video cable pulling loop 	Cable pulling loop with hook (quick-release fastener) - set of 4 Caps outside Ø: 14 17 23 30 mm stainless steel, PU = 4 pieces	10159	42,20 €

Information



Compatible cable pulling grip range see page 33.

30m



SPECIAL OFFER

1 x RP5 without meter counter, 30 m
1 x X BOARD XB 300 with multifunction mandrel in RUNPOTEC system case, p. 8

INSTEAD OF € 387,⁴⁰

€ 314,⁷
plus VAT.

RP5 - 30 m - XB 300 - Multiset - offer
RUNPOTEC item no. 10171

30m



60m



Accessories included in the storage compartment



SPECIAL OFFER

1 x RP5 without meter counter - 30 m
1 x GF4.5 Fiberglass rod Ø 4,5 mm - 60 m, incl. steel cage, see page 36

INSTEAD OF € 503,⁰⁰

€ 411,⁷
plus VAT.











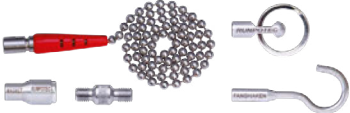



















RP5 - 30 m - GF4.5 - 60 m - offer
RUNPOTEC item no. 11120

RUNPOSTICKS



Item		Item no.	Rec. trade price
	<p>RUNPOSTICKS - Comfort-package (19-parts)</p> <p>10 x Basalt rods with extreme bending radius, 5 x 1 m red/hard Ø 7,5 mm, 3 x 1 m black/medium Ø 5,5 mm, 2 x 1 m yellow/soft Ø 4,5 mm stainless steel, RTG Ø 6 mm thread</p> <p>1 x RG7 - Guiding head incl. swivel, 1 x Strong magnet, 1 x connection thread, 1 x Ball chain, 1 x eyelet with ring, 1 x fishing hook, 1 x Special sliding hook, stainless steel 1 x Shockproof LED-lamp incl. 1 x AAA battery 1 x Storage bag with shoulder strap</p>	10020	139,00 €
	<p>RUNPOSTICKS - Standard-package (17-parts)</p> <p>Content: same as RUNPOSTICKS Comfort-package without special sliding hook and shockproof LED-lamp (Description see above)</p>	10016	119,00 €
	<p>Special sliding hook – Stainless steel overcomes obstacles up to 8 cm, excellent gliding behaviour for all surfaces, with tilt function, extensive mounting options for cable RTG Ø 6 mm thread</p>	30239	20,80 €
	<p>Functionglider RTG Ø 6 mm thread</p>	20468	20,60 €
	<p>LED-Lamp 130 lumen incl. 1 x AAA battery, shockproof, extra long battery life, RTG Ø 6 mm thread</p>	20059	21,60 €
	<p>High-performance rechargeable LED-lamp 320 lumen, USB-C charging socket (incl. Li-ion battery), protection rating IP67 2 x RTG Ø 6 mm thread (1 x vertical and 1 x horizontal)</p> <p>Detail: USB-C charging socket</p>	20485	47,40 €

All prices are ex-works 5303 - Thalgau - AUSTRIA - plus statutory taxes and duties. All price information represents non-binding price recommendations. Pricelist 2024. All illustrations are symbol photos. Typing and printing errors reserved.

Item	Item no.	Rec. trade price
 	10042	24,70 €
  <p>Video RG - RUNPOGLIDER guiding head</p>	20238	29,00 €
 	10043	19,00 €
 	10044	20,00 €
 	10045	20,00 €
 	20457	12,40 €
 	20261	7,00 €
 	30236	5,50 €
 	20260	9,30 €
 	30210	4,30 €
 	20262	10,30 €
 	20428 20427	7,10 € 7,10 €
  <p>Product fish hook set</p>	20614	24,70 €
	20455	17,50 €
	30009	22,70 €
  <p>Video cable pulling loop</p>	10154	42,20 €

GF3 Glass Fiber Ø 3 mm – Cable pulling system

VIDEO



GF3

KG 130

PATENTED

RC2 – Inspection camera COMPATIBLE



Ergonomic holding and carrying handle

RG7 - Guiding head with front thread incl. swivel and kink protection

Automatic glide back protection

Integrated digital meter counter – m/ft

Accessory box (16-parts)

Attention! electrically conductive

Front end: Guiding head with RTG Ø 6 mm front thread, swivel and kink protection

Rear end: Kink protection with RTG Ø 6 mm inner thread

*Accessory box (16-parts)



Extreme bending radius

Revolutionary kink protection

R = 38 mm

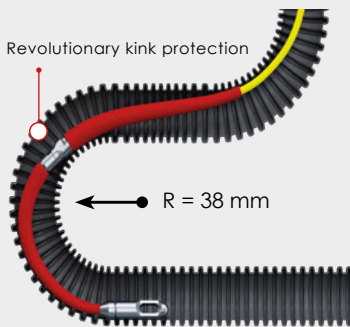

Easy service opening / accessory box



Anti-slip coating

Just open one screw











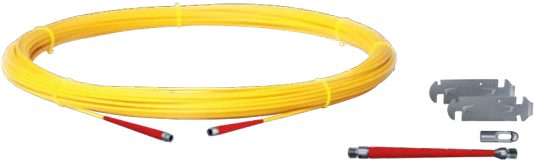









Accessory box 16-parts



Rod	Rec. pipe diameter	Bending radius w. e. joint	Bending radius rod	Breaking load	Total breaking load
Ø 3 mm	10 – 50 mm	38 mm	28 mm	450 kg	130 kg

Item		Length	Item no.	Rec. trade price	
	GF3 Glass Fiber Ø 3 mm with integrated digital meter counter – ft/m 2 x kink protection on fiberglass rod 16-piece accessories (*see content) Box with anti-slip coating	20 m	10192	184,00 €	
		30 m	10193	199,00 €	
		Introductory price			169,00 €
		50 m	10195	219,00 €	
	GF3 Glass Fiber Ø 3 mm without meter counter 2 x kink protection on fiberglass rod 16-piece accessories (*see content) Box with anti-slip coating	20 m	10196	117,50 €	
		30 m	10197	131,00 €	
		50 m	10198	156,50 €	

All prices are ex-works 5303 - Thalgau - AUSTRIA - plus statutory taxes and duties. All price information represents non-binding price recommendations. Pricelist 2024. All illustrations are symbol photos. Typing and printing errors reserved.

Item	Item no.	Rec. trade price
	<p>GF3 Replacement fiberglass rod Ø 3 mm incl. RG7 - Guiding head with front thread and eyelet Ø 7 mm incl. swivel RTG Ø 6 mm thread</p> <p>20 m 30 m 50 m</p>	<p>20816 46,50 € 20817 54,60 € 20818 66,00 €</p>
 	<p>GF3 Repairing-kit Ø 3 mm – 15-parts 1 x RG7 - Guiding head with front thread 2 x Kink protection 1 x Special glue 3 g 2 x Mounting wrench 1 x Eyelet Ø 7 mm 6 x Adhesive joint for Ø 3 mm 1 x Coupling joint for Ø 3 mm 1 x Starting head Ø 11 mm stainless steel, RTG Ø 6 mm thread</p>	<p>20819 36,80€</p>
 	<p>GF3 Guiding head with kink protection-set Ø 3 mm, stainless steel, RTG Ø 6 mm thread 1 x RG7 - Guiding head with front thread 1 x Kink protection 2 x Mounting wrench 1 x Eyelet Ø 7 mm</p>	<p>20826 30,50 €</p>
	<p>GF3 Adhesive joint-set Ø 3 mm Brass, PU = 6 pieces</p>	<p>20824 6,00 €</p>
 	<p>GF3 Mounting-wrench-set Ø 3 mm stainless steel, PU = 2 pieces</p>	<p>20825 4,20 €</p>
 	<p>Eyelet-set Ø 7 mm stainless steel, RTG Ø 6 mm thread, PU = 3 pieces</p>	<p>20487 9,40 €</p>
 	<p>Pulling eyelet-set Ø 7 mm stainless steel, RTG Ø 6 mm thread, PU = 3 pieces</p>	<p>20411 7,20 €</p>
 	<p>Starting head Ø 11 mm stainless steel, RTG Ø 6 mm thread</p>	<p>20829 4,10 €</p>
	<p>Magnet fishing-set 1,5 – 2,9 kg (tube Ø 16 – 40 mm) 5 kg STRONG (tube Ø 50 – 100 mm) RTG Ø 6 mm thread</p>	<p>20475 23,70 € 20476 47,40 €</p>
 	<p>Coupling joint-set GF3 Ø 3 mm stainless steel, PU = 3 pieces</p>	<p>20108 7,20 €</p>
 	<p>Cable pulling grip with thread incl. swivel stainless steel, RTG Ø 6 mm thread Ø 4 – 6 mm Ø 6 – 9 mm Ø 9 – 13 mm</p>	<p>20365 18,50 € 20366 19,60 € 20367 29,90 €</p>
 	<p>Cable pulling loop with RTG 6 thread – set of 4 Protective caps outside Ø: 14 17 23 30 mm stainless steel, RTG Ø 6 mm thread PU = 4 pieces</p>	<p>10154 42,20 €</p>

GF3 SLIM Ø 4.5 mm Glass Fiber Ø 3 mm – Cable pulling system

VIDEO



GF3 SLIM

KG 100

PATENTED





RG4.5 - Guiding head with front thread (RTG Ø 3 mm) incl. swivel

Automatic glide back protection

Integrated digital meter counter - m/ft



Beginning: RG4.5 - Guiding head with front thread (RTG Ø 3 mm) incl. swivel



Ending: Ending joint with RTG Ø 3 mm, stainless steel



Attention! electric conductive



***Accessory box (14-parts)**



FTTH - Glass fiber installation

Speedpipe from Ø 5 mm inner diameter

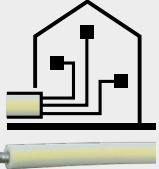

Ideally suited for occupied pipes

RG4.5 Guiding head Ø 4,5 mm



Easy service opening / accessory box





Anti-slip-coating













Just open one screw

Accessory box 14-parts

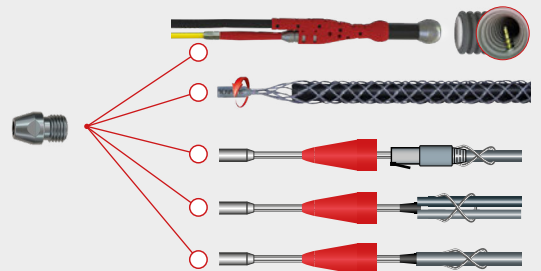
Rod	Rec. pipe diameter	Bending radius w. e. joint	Bending radius rod	Breaking load	Total breaking load
Ø 3 mm	5 – 50 mm	40 mm	28 mm	450 kg	100 kg

Item		Length	Item no.	Rec. trade price		
	GF3 SLIM Glass Fiber Ø 3 mm with integrated digital meter counter – ft/m RG4.5 - Guiding head with front thread incl. swivel 14-piece accessories (*see content) Box with anti-slip coating	20 m	10207	182,00 €		
		30 m	10208	197,00 €		
		Introductory price		50 m	10209	167,00 €
		50 m	10209	217,00 €		
	GF3 SLIM Glass Fiber Ø 3 mm without meter counter RG4.5 - Guiding head with front thread incl. swivel 14-piece accessories (*see content) Box with anti-slip coating	20 m	10210	115,50 €		
		30 m	10211	129,00 €		
		50 m	10212	154,50 €		

All prices are ex-works 5303 - Thalgau - AUSTRIA - plus statutory taxes and duties. All price information represents non-binding price recommendations. Pricelist 2024. All illustrations are symbol photos. Typing and printing errors reserved.

Item	Item no.	Rec. trade price
	<p>GF3 SLIM Replacement fiberglass rod Ø 3 mm with ending joints, incl. RG4.5 - Guiding head, eyelet and starting head Ø 4,5 mm</p> <p>20 m 30 m 50 m</p>	<p>20952 35,00 € 20953 43,00 € 20954 55,00 €</p>
	<p>GF3 SLIM Repairing-kit Ø 3 mm – 8-parts</p> <p>1 x Special glue 3 g 5 x Ending joint with RTG Ø 3 mm thread 2 x Coupling joint Ø 3 mm</p>	<p>20951 19,90 €</p>
	<p>GF3 SLIM Ending joint-set</p> <p>stainless steel, RTG Ø 3 mm thread, PU = 5 pieces</p>	<p>20950 10,90 €</p>
	<p>GF3 SLIM Pulling eyelet-set Ø 4,5 mm</p> <p>stainless steel, RTG Ø 3 mm thread, PU = 3 pieces</p>	<p>20947 7,90 €</p>
	<p>GF3 SLIM Starting head-set Ø 4,5 mm</p> <p>stainless steel, RTG Ø 3 mm thread, PU = 3 pieces</p>	<p>20948 8,00 €</p>
	<p>GF3 SLIM Starting head-set Ø 6 mm</p> <p>stainless steel, RTG Ø 3 mm thread, PU = 3 pieces</p>	<p>20949 8,50 €</p>
	<p>GF3 SLIM Adapter thread-set</p> <p>RTG Ø 3 mm internal thread to RTG Ø 6 mm external thread stainless steel, PU = 3 pieces</p>	<p>20955 9,50 €</p>
<p>Combination options – from RTG Ø 3 mm internal thread to RTG Ø 6 mm external thread</p>  <ul style="list-style-type: none"> With the RC2 Inspection camera head With cable pulling grip – RTG Ø 6 mm thread With cable pulling loop for cable with plug With cable pulling loop for duplex cable With cable pulling loop for single cable 		
	<p>GF3 Coupling joint-set Ø 3 mm</p> <p>for GF3 and GF3 SLIM, stainless steel, PU = 3 pieces</p>	<p>20108 7,20 €</p>
 <p>Only Ø 4,5 mm</p>	<p>RG4.5 - Guiding head with front thread (RTG Ø 3 mm) incl. swivel</p> <p>stainless steel, RTG Ø 3 mm thread</p>	<p>20956 22,00 €</p>
	<p>Pulling grip</p> <p>for fiberglass rod Ø 3 – 6 mm</p>	<p>30070 6,40 €</p>
	<p>Special glue 3 g</p>	<p>30050 8,40 €</p>
 <p>NON-INFLAMMABLE</p> <p>Tip: Ask for the package price</p>	<p>Cable lubricant SPRAY 400 ml Cable lubricant FOAM SPRAY 400 ml (with folding spray tube) Non inflammable</p> <p>Cable lubricant GEL 1000 g Cable lubricant GEL 250 g</p>	<p>20523 8,00 € 20522 7,00 €</p> <p>30064 8,70 € 30467 4,30 €</p>

RT 2008 Mechanical cable pulling tool



RT 2008

The problem solver for low pipe cross section
Ø 13 – 32 mm



W-BOX | Sortimo COMPATIBLE

1. Induct



2. Fix



3. Pump



Item		Item no.	Rec. trade price
	RT 2008 - complete-set 1 x RT 2008 1 x RUNPOTEC system case, with RT 2008 case inlay 1 x MET4 metal spiral with RG6 - Guiding head – 15 m Plug-in attachments: 1 x Ø 20 mm, 1 x Ø 25 mm, 1 x Ø 32 mm, 1 x Ø 40 mm, 1 x socket flexible, 2 x plug in coupling, 1 x belt clip	10000	308,00 €
	RT 2008 incl. clamping element	20004	183,00 €
	Set plug in coupling + belt clip	20333	8,20 €
	Plug-in attachment Ø 20 mm	20020	9,30 €
	Plug-in attachment Ø 25 mm	20025	9,30 €
	Plug-in attachment Ø 32 mm	20032	9,30 €
	Plug-in attachment Ø 40 mm	20040	9,30 €
	Plug-in attachment socket flexible	20010	8,20 €
	Plug-in attachment 90° rigid socket (also for pipe Ø 16 and 20 mm)	20253	17,50 €
	RUNPOTEC system case with RT 2008 case inlay	20611	56,00 €

All prices are ex-works 5303 - Thalgau - AUSTRIA - plus statutory taxes and duties. All price information represents non-binding price recommendations. Pricelist 2024. All illustrations are symbol photos. Typing and printing errors reserved.

MET4 Steel fish tape Ø 4 mm



Beginning: RG7 - Guiding head with special eyelet Ø 6 mm, pressed onto strand.

Ending: Eyelet Ø 6 mm, pressed onto strand



Optimal in combination with the revolutionary RT 2008

 3 times offset wound metal spiral

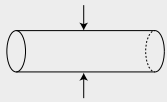
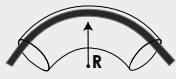

Application example / symbol image

MET4, metal spiral Ø 4 mm. Special eyelet: 1 x RG6 - Guiding head with special eyelet. Excellent bending and gliding behavior, large eyelet with hole up to 7 x 2.5 mm² cable, perfect fabrication, no hems and high breaking load. Ending: eyelet Ø 6 mm, pressed onto strand. Optimal pipe diameters: Tube Ø 16, 25 and 32 mm

Rod	Rec. pipe diameter	Bending radius rod	TBL - ending	Total breaking load - beginning
Ø				
4 mm	13 - 32 mm	25 mm	170 Kg	170 Kg

Item	Length	Item no.	Rec. trade price
	MET4 metal spiral Ø 4 mm Total breaking load: 170 Kg	30054	19,60 €
	5 m	30017	26,80 €
	10 m	30018	35,00 €
	15 m	30019	43,30 €
	20 m	30020	52,00 €
	25 m	30021	56,00 €
	30 m	30031	Price o. r.
Lengths up to 50 m possible			

ACCESSORIES – useful in combination with MET4

Item	Ø	Item no.	Rec. trade price
	Cable pulling grip with quick-release fastener incl. swivel, stainless steel	20272	26,80 €
	4 – 6 mm	20273	29,90 €
	6 – 9 mm	20274	34,00 €
Application: Quick-release fastener compatible with RG - RUNPOGLIDER guiding head			

CABLE PULLING LOOP with hook (quick connection) / RTG 6 thread



Cable pulling loop with hook or RTG Ø 6 mm thread, with protective cap and flexible loop made of stainless steel with Ø 1.5 mm. Optimal field of application: To pull pre-fabricated cables incl. plugs in a protected manner. For pipes with an inner diameter of 14 mm or more and non-guided lines.

Examples: pulling force transferred to the cable

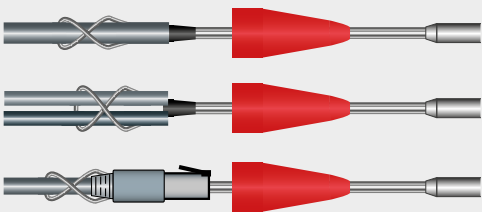

Use the protective cap to pull the plugs through pipes or other situations in a protected manner. 4 variants for different plug sizes.

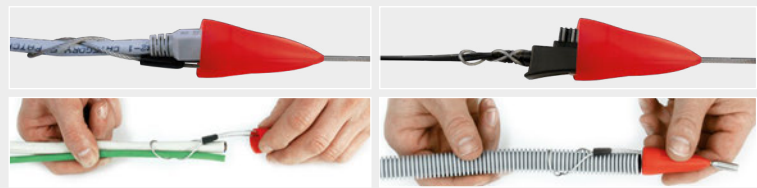

Connect: cable pulling loop with hook (compatible with all RUNPOTEC products with RG - guide heads)



Connect: pulling loop with RTG Ø 6 mm thread

Swivel allows the cable to rotate in the tube



Item		Caps inner Ø	Caps outside Ø	Item no.	Rec. trade price
	Cable pulling loop with hook (quick-release fastener) – set of 4 Total breaking load: 100 kg stainless steel PU = 4 pieces	12 mm	14 mm	10159	42,20 €
		15 mm	17 mm		
		20 mm	23 mm		
		27 mm	30 mm		
	Cable pulling loop with hook (quick-release fastener) – individually Total breaking load: 100 kg stainless steel	12 mm	14 mm	20628	14,40 €
		15 mm	17 mm	20629	14,90 €
		20 mm	23 mm	20630	15,50 €
		27 mm	30 mm	20631	16,00 €
	Cable pulling loop with RTG 6 thread – set of 4 Total breaking load: 100 kg stainless steel, RTG Ø 6 mm thread PU = 4 pieces	12 mm	14 mm	10154	42,20 €
		15 mm	17 mm		
		20 mm	23 mm		
		27 mm	30 mm		
	Cable pulling loop with RTG 6 thread – individually Total breaking load: 100 kg stainless steel, RTG Ø 6 mm thread	12 mm	14 mm	20624	14,40 €
		15 mm	17 mm	20625	14,90 €
		20 mm	23 mm	20626	15,50 €
		27 mm	30 mm	20627	16,00 €

All prices are ex-works 5303 - Thalgau - AUSTRIA - plus statutory taxes and duties. All price information represents non-binding price recommendations. Pricelist 2024. All illustrations are symbol photos. Typing and printing errors reserved.

CABLE PULLING GRIP with hook (quick connection) / RTG 6 thread / loop



For **cable diameter Ø 4 – 15 mm**. Compatible with RP5, RP1, GF3 / GF4.5 / GF6 Fiberglass rod, RUNPOSTICKS. Made of high quality stainless steel weave. Extremely long service life thanks to new connection technology.

Item	Total breaking load	Weave length	Ø	Item no.	Rec. trade price
Cable pulling grip with quick-release fastener incl. swivel, stainless steel	 200 kg	280 mm	Ø 4 – 6 mm	20272	26,80 €
		310 mm	Ø 6 – 9 mm	20273	29,90 €
		460 mm	Ø 9 – 15 mm	20274	34,00 €



For **cable diameter Ø 4 – 13 mm**. Compatible with GF3 / GF3 SLIM (incl. adapter thread) / GF4.5 / GF6 Fiberglass rod and RUNPOSTICKS. Made of high quality stainless steel weave. High-quality materials with a long service life! Advantages of swivel: Cable can rotate in the tube, prevents unintentional unscrewing from the thread.

Item	Total breaking load	Weave length	Ø	Item no.	Rec. trade price
Cable pulling grip with RTG Ø 6 mm thread incl. swivel stainless steel	 120 kg	200 mm	Ø 4 – 6 mm	20365	18,50 €
		220 mm	Ø 6 – 9 mm	20366	19,60 €
		320 mm	Ø 9 – 13 mm	20367	29,90 €

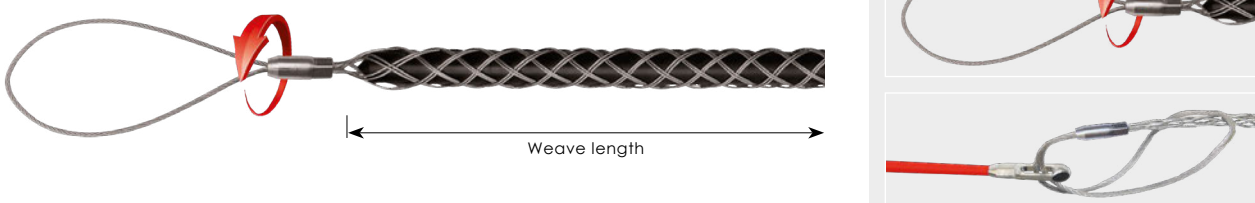

For **cable diameter Ø 4 – 13 mm**. Compatible with GF3 / GF3 SLIM / GF4.5 / GF6 Fiberglass rod and RUNPOSTICKS. Made of high quality stainless steel weave. High-quality materials with a long service life! Advantages of swivel: Cable can rotate in the tube, prevents unintentional unscrewing from the thread.

Item	Total breaking load	Weave length	Ø	Item no.	Rec. trade price
Cable pulling grip with loop incl. swivel loop length 100 mm, stainless steel	 200 kg	270 mm	Ø 4 – 6 mm	30039	21,60 €
		290 mm	Ø 6 – 9 mm	30040	23,70 €
		390 mm	Ø 9 – 13 mm	30041	36,10 €

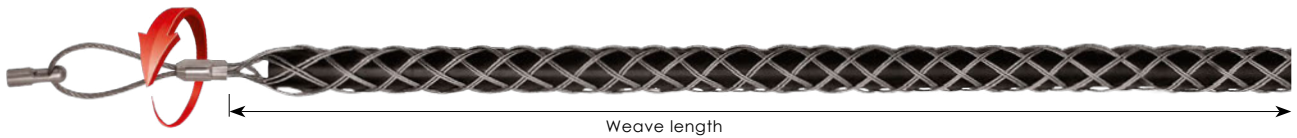

For **cable diameter Ø 9 – 31 mm**. Compatible with GF3 / GF4.5 / GF6 / GF7.5 / GF9 / GF11 fiberglass rod and RUNPOSTICKS. Made of high quality stainless steel weave. High-quality materials with a long service life!
 Advantages of swivel: Cable can rotate in the tube, prevents unintentional unscrewing from the thread.

Item	Total breaking load	Weave length	Ø	Item no.	Rec. trade price
Cable pulling grip with loop and RTG Ø 6 mm thread incl. swivel stainless steel Information: Not optimal in combination with CW 800 E Capstan winch	180 kg	430 mm	Ø 9 – 15 mm	20266	41,20 €
		480 mm	Ø 15 – 19 mm	20267	43,30 €
		480 mm	Ø 19 – 25 mm	20268	44,30 €
		530 mm	Ø 25 – 31 mm	20269	46,40 €
Quick-release fastener with RTG Ø 6 mm thread For connecting RUNPOTEC cable pulling grip with RTG Ø 6 mm thread to all RUNPOTEC products with the RG - RUNPOGLIDER guiding head				20388	22,70 €



For **cable diameter Ø 30 – 100 mm**. Preferably in combination with all fiberglass rods and RUNPOTEC products with RTG Ø 12 mm thread. Made of high quality stainless steel weave.
 Advantages of swivel: Cable can rotate in the tube, prevents unintentional unscrewing from the thread.

Item	Total breaking load	Weave length	Ø	Item no.	Rec. trade price
Cable pulling grip with loop and RTG Ø 12 mm thread incl. swivel With additional RTG Ø 6 mm thread stainless steel Information: Not optimal in combination with CW 800 E capstan winch	1000 kg	920 mm	Ø 30 – 40 mm	20436	64,00 €
		1020 mm	Ø 40 – 50 mm	20437	68,00 €
		1120 mm	Ø 50 – 60 mm	20438	72,00 €
		1220 mm	Ø 60 – 70 mm	20439	81,00 €
		1320 mm	Ø 70 – 85 mm	20440	96,00 €
		1420 mm	Ø 85 – 100 mm	20441	113,00 €



For **cable diameter Ø 10 – 100 mm**. Preferably combined with CW 800 E Capstan winch. Made of flexible, galvanized steel double weave. In the case of permanent tension, it is recommended to work in combination with the connection swirl with swivel (see accessories item no. 10176).

Item	Total breaking load	Weave length	Ø	Item no.	Rec. trade price
Cable pulling grip with loop Flexible, galvanized steel double weave Long lifetime  CW 800 E – capstan winch COMPATIBLE	1019 kg	600 mm	Ø 10 - 15 mm	20661	41,20 €
	2080 kg	600 mm	Ø 15 - 20 mm	20662	43,30 €
	2080 kg	600 mm	Ø 20 - 25 mm	20663	44,30 €
	2080 kg	1000 mm	Ø 25 - 30 mm	20664	48,40 €
	3059 kg	1250 mm	Ø 30 – 40 mm	20665	55,00 €
	4078 kg	1250 mm	Ø 40 – 50 mm	20666	60,00 €
	4996 kg	1500 mm	Ø 50 – 60 mm	20667	70,00 €
	4996 kg	1500 mm	Ø 60 – 70 mm	20668	82,00 €
	4996 kg	1500 mm	Ø 70 – 85 mm	20669	96,00 €
	5812 kg	1500 mm	Ø 85 – 100 mm	20670	109,00 €

ACCESSORIES – Optimal in combination with cable pulling grip, pull rope and CW 800 E Capstan winch

Item	Item no.	Rec. trade price
 Connection swirl with swivel Ø 30 mm L 144 mm, stainless steel	10176	196,00 €

All prices are ex-works 5303 - Thalgau - AUSTRIA - plus statutory taxes and duties. All price information represents non-binding price recommendations. Pricelist 2024. All illustrations are symbol photos. Typing and printing errors reserved.

Cabel examples with diameters

Cabel pulling grip

Cable-symbolphoto	Cable Ø	Cable section	Cable identification	Ø	Item no.
	5 mm	2 x 0,5 mm ²	Loudspeaker	4-6 mm	20272
	5,4 mm	-	Phone	4-6 mm	20365
				4-6 mm	30039
	7 mm	-	CAT5/6/7	6-9 mm	20273
	7 mm	1 x 6 mm ²	NYM-J	6-9 mm	20366
	8 mm	-	Coaxial	6-9 mm	30040
	9 mm	3 x 1,5 mm ²	NYM-O		
	10 mm	3 x 2,5 mm ²	NYM	9-13 mm	20367
	10 mm	1 x 10 mm ²	NYY-O	9-13 mm	30041
	10 mm	1 x 16 mm ²	NYM-O	9-15 mm	20274
	11 mm	7 x 1,5 mm ²	NYM-O	9-15 mm	20266
	11 mm	5 x 2,5 mm ²	NYM	10 - 15 mm	20661
	11 mm	5 x 1,5 mm ²	NYY		
	13 mm	3 x 2,5 mm ²	NYY		
	14 mm	1 x 35 mm ²	NYY-O		
	15 mm	12 x 1,5 mm ²	NYM-JZ		
	15 mm	7 x 2,5 mm ²	NYM		
	15 mm	3 x 6 mm ²	NYM-J		
	15 mm	-	CAT6 duplex		
	17 mm	16 x 1,5 mm ²	NYM-J	15-19 mm	20267
	17 mm	5 x 6 mm ²	NYM-J	15 - 20 mm	20662
	18 mm	4 x 10 mm ²	NYM-J		
	18 mm	1 x 95 mm ²	NYY-O		
	20 mm	10 x 2,5 mm ²	NYCY	19-25 mm	20268
	21 mm	5 x 10 mm ²	NYY-J	20 - 25 mm	20663
	22 mm	12 x 2,5 mm ²	NYCY		
	22 mm	4 x 16 mm ²	NYM-J		
	24 mm	7 x 6 mm ²	NYCY		
	25 mm	1 x 185 mm ²	NYY-O		
	28 mm	3 x 35 mm ²	NYCWY	25-31 mm	20269
	29 mm	24 x 2,5 mm ²	NYCY	25 - 30 mm	20664
	32 mm	1 x 300 mm ²	NYY-O	30-40 mm	20436
	33 mm	40 x 2,5 mm ²	NYY-JZ		20665
	34 mm	5 x 35 mm ²	NYM-J		
	40 mm	3 x 95 mm ²	NYCWY		
	45 mm	3 x 120 mm ²	NYCWY	40-50 mm	20437
	47 mm	3 x 150 mm ²	NYCWY		20666
	52 mm	5 x 95 mm ²	NYY-J	50-60 mm	20438
	54 mm	3 x 185 mm ²	NYCWY		20667
	60 mm	3 x 240 mm ²	NYCWY		
	63 mm	4 x 240 mm ²	NYY-J	60-70 mm	20439
					20668

GF4.5 Fiberglass rod Ø 4.5 mm – Cable pulling system



GF4.5



KG
220



PATENTED



RC2 –
Inspection camera
COMPATIBLE



Profi-Set

Ergonomic holding and carrying handle

Lateral parking brake

RG7 - Guiding head with front thread and eyelet

Double run-out system, quick outlet and automatic run-out brake

Extendable standing feet and storage compartment incl. accessories



Attention!
electric
conductive

Beginning: RG7 - Guiding head with swivel Ø 7 mm, RTG Ø 6 mm thread, screwed to strand



Ending: Ending joint, stainless steel, RTG Ø 6 mm thread





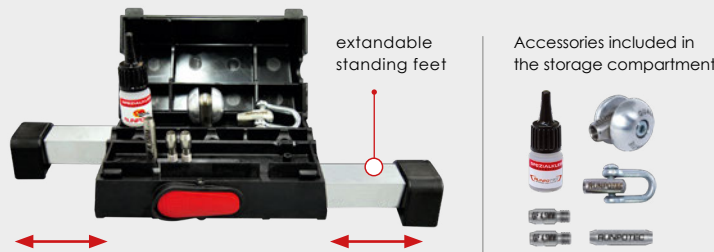



Included in the Profi-Set:
Extendable standing feet a. storage compartment incl. accessories

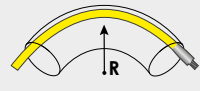

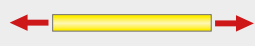
Included in the Profi-Set and Standard-Set:
Lateral parking brake and double run-out system (quick outlet and automatic run-out brake)



Rod	Rec. pipe diameter	Bending radius w. e. joint	Bending radius rod	Breaking load	Total breaking load
Ø					
4,5 mm	30 – 80 mm	120 mm	55 mm	1300 kg	220 kg

Item		Length	Item no.	Rec. trade price
	GF4.5 Fiberglass rod Ø 4.5 mm – Profi-Set	30 m	10052	260,00 €
	• Extendable standing feet	40 m	10055	287,00 €
	• Storage compartment on both sides incl. extensive accessories	50 m	10057	315,00 €
	• Double run-out system and lateral parking brake	60 m	10047	341,00 €
	• RG7 - Guiding head with front thread and eyelet incl. swivel	80 m	10050	396,00 €
	GF4.5 Fiberglass rod Ø 4.5 mm – Standard-Set	30 m	10054	192,00 €
	• Double run-out system and lateral parking brake	40 m	10056	218,00 €
	• RG7 - Guiding head with front thread and eyelet incl. swivel	50 m	10058	244,00 €
	• Robust CDP / powder-coated steel reel	60 m	10048	269,00 €
	Dimensions: L 365 mm W 260 mm H 435 mm	80 m	10051	325,00 €

All prices are ex-works 5303 - Thalgau - AUSTRIA - plus statutory taxes and duties. All price information represents non-binding price recommendations. Pricelist 2024. All illustrations are symbol photos. Typing and printing errors reserved.

Special offer / accessories / spare parts

30m + 60m

Accessories included in the storage compartment

SPECIAL OFFER

1 x RP5 without meter counter - 30 m, description page 22

1 x GF4.5 Fiberglass rod Ø 4,5 mm - 60 m incl. steel cage

INSTEAD OF € 503,00

€ 411,-
plus VAT.

RP5 - 30 m - GF4.5 - 60 m - offer
RUNPOTEC item no. 11120

50m + 50m

SPECIAL OFFER

1 x GF4.5 Fiberglass rod Ø 4,5 mm - 50 m,























1 x RC2 Inspection camera - 50 m, in the system case, description page 18

INSTEAD OF € 923,00

€ 789,-
plus VAT.

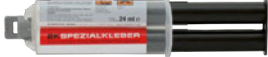
RC2 - 50 m - GF4.5 - 50 m - offer
RUNPOTEC item no. 11140

Item		Ø mm	Length	Item no.	Rec. trade price
	GF4.5 Replacement fiberglass rod Ø 4,5 mm with ending joints on both sides RTG Ø 6 mm thread		30 m	20311	82,00 €
			40 m	20312	97,00 €
			50 m	20313	113,00 €
			60 m	20314	131,00 €
			80 m	20315	162,00 €
<p>Video RG - RUNPOGLIDER guiding head</p>	RG7 - Guiding head with front thread and eyelet Ø 7 mm incl. swivel stainless steel, RTG Ø 6 mm thread			20460	29,00 €
<p>Symbol picture</p>	Flexible starting head stainless steel RTG Ø 6 mm thread	7	20116	8,00 €	
		10	20303	8,20 €	
		13	20119	8,20 €	
<p>Information: Cable pulling grip range see page 33</p>	Cable pulling grip with swivel stainless steel RTG Ø 6 mm thread	9 - 15	20266	41,20 €	
		15 - 19	20267	43,30 €	
		19 - 25	20268	44,30 €	
		25 - 31	20269	46,40 €	
<p>NON-INFLAMMABLE</p> <p>Tip: Ask for the package price</p>	Cable lubricant SPRAY 400 ml Cable lubricant FOAM 400 ml (with folding spray tube) Non inflammable		20523	8,20 €	
			20522	7,10 €	
	Cable lubricant GEL 1000 g Cable lubricant GEL 250 g		30064	8,90 €	
			30467	4,40 €	

Item	Item no.	Rec. trade price
	Roller Ø 25 mm stainless steel / aluminium RTG Ø 6 mm thread	20279 18,50 €
	Shackle stainless steel / galvanised steel RTG Ø 6 mm thread	20280 15,50 €
  Repair manual www.runpotec.com 	GF4.5 Repairing-kit for Ø 4,5 mm 1 x special glue 3 g, 1 x coupling joint, 2 x ending joint RTG Ø 6 mm	20250 22,70 €
 	GF4.5 Ending joint-set for Ø 4,5 mm stainless steel, RTG Ø 6 mm thread PU = 3 ending joint	20322 11,30 €
 	GF4.5 Coupling joint-set for Ø 4,5 mm stainless steel PU = 3 coupling joint	20323 14,40 €
 	Eyelet Ø 8 mm stainless steel, RTG Ø 6 mm thread	30208 4,90 €
 	Eyelet-set Ø 7 mm stainless steel, RTG Ø 6 mm thread	20487 9,40 €
 	Swivel joint Ø 11 mm stainless steel, RTG Ø 6 mm thread	20251 24,70 €
 	Pull loop , stainless steel rope RTG Ø 6 mm thread Ø 1,5 mm (loop length 75 mm) Ø 2 mm (loop length 35 mm)	20428 7,10 € 20427 7,10 €
	Special glue 3 g	30050 8,40 €
	2 components special glue 24 ml	30067 20,60 €
	Pulling grip for fiberglass rod Ø 3 – 12 mm	30070 6,40 €
	Extendable standing feet incl. storage compartment for reel Ø 330 mm and Ø 530 mm	20278 43,30 €
	GF4.5 Profi-set steel reel Ø 330 mm for Ø 4,5 mm incl. double run-out system with extendable standing feet and storage compartment for accessories CDP/powder coated	20402 183,00 €
	GF4.5 Standard-set steel reel Ø 330 mm for Ø 4,5 mm incl. double run-out system and parking brake CDP/powder coated	20002 133,00 €

GF6 Fiberglass rod Ø 6 mm – Cable pulling system

VIDEO



GF6

KG 320

PATENTED

RC2 – Inspection camera COMPATIBLE



Profi-Set

Ergonomic holding and carrying handle

Lateral parking brake

RG7 - Guiding head with front thread and eyelet

Double run-out system, quick outlet and automatic run-out brake

Extendable standing feet and storage compartment incl. accessories

Attention! electric conductive

Beginning: RG7 - Guiding head with swivel Ø 7 mm, RTG Ø 6 mm thread, screwed to strand



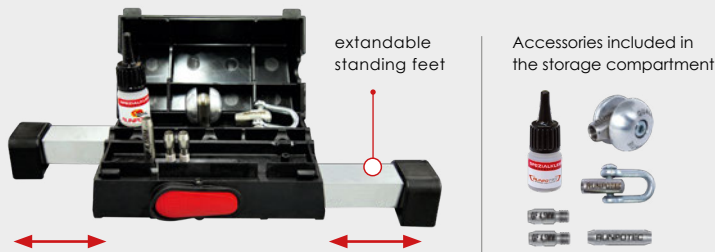

Ending: Ending joint, stainless steel, RTG Ø 6 mm thread



Included in the Profi-Set:
Extendable standing feet a. storage compartment incl. accessories

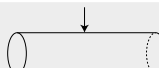

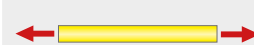























Included in the Profi-Set and Standard-Set:
Lateral parking brake and double run-out system (quick outlet and automatic run-out brake)















Rod	Rec. pipe diameter	Bending radius w. e. joint	Bending radius rod	Breaking load	Total breaking load
Ø					
6 mm	40 - 100 mm	168 mm	80 mm	2200 kg	320 kg

Item		Length	Item no.	Rec. trade price
	GF6 Fiberglass rod Ø 6 mm – Profi-Set	40 m	10059	321,00 €
	• Extendable standing feet	50 m	10061	349,00 €
	• Storage compartment on both sides incl. extensive accessories	60 m	10063	381,00 €
	• Double run-out system and lateral parking brake	80 m	10065	448,00 €
	GF6 Fiberglass rod Ø 6 mm – Standard-Set	40 m	10060	265,00 €
	• Double run-out system and lateral parking brake	50 m	10062	293,00 €
	• RG7 - Guiding head with front thread and eyelet incl. swivel	60 m	10064	325,00 €
	• Robust CDP / powder-coated steel reel	80 m	10066	390,00 €
Dimensions: L 550 mm W 210 mm H 660 mm				

Item	Item no.	Rec. trade price
	<p>GF6 Replacement fiberglass rod Ø 6 mm with ending joints on both sides RTG Ø 6 mm thread</p> <p>40 m 50 m 60 m 80 m</p>	<p>20317 106,00 € 20318 129,00 € 20319 148,00 € 20320 188,00 €</p>
 <p>Video RG - RUNPOGLIDER guiding head</p> 	<p>RG7 - Guiding head with front thread and eyelet Ø 7 mm incl. swivel stainless steel, RTG Ø 6 mm thread</p>	<p>20460 29,00 €</p>
 	<p>Flexible starting head Ø 7 mm stainless steel, RTG Ø 6 mm thread</p>	<p>20116 8,00 €</p>
 	<p>Flexible starting head Ø 10 mm stainless steel, RTG Ø 6 mm thread</p>	<p>20303 8,20 €</p>
 	<p>Flexible starting head Ø 13 mm stainless steel, RTG Ø 6 mm thread</p>	<p>20119 8,20 €</p>
 <p>Information: Cable pulling grip range see page 33</p>	<p>Cable pulling grip with swivel stainless steel, RTG Ø 6 mm thread</p> <p>Ø 9 – 15 mm Ø 15 – 19 mm Ø 19 – 25 mm Ø 25 – 31 mm</p>	<p>20266 41,20 € 20267 43,30 € 20268 44,30 € 20269 46,40 €</p>
	<p>Roller Ø 25 mm stainless steel / aluminium RTG Ø 6 mm thread</p>	<p>20279 18,50 €</p>
	<p>Shackle stainless steel / galvanised steel RTG Ø 6 mm thread</p>	<p>20280 15,50 €</p>
 <p>Repair manual, www.runpotec.com</p> 	<p>GF6 Repairing-kit for Ø 6 mm 1 x 2K-special glue 24 ml 2 x Ending joints, RTG Ø 6 mm thread 1 x Coupling joint</p>	<p>20252 40,20 €</p>
 	<p>GF6 Ending joint-set for Ø 6 mm stainless steel, RTG Ø 6 mm thread PU = 2 ending joint</p>	<p>20316 12,40 €</p>
 	<p>GF6 Coupling joint-set for Ø 6 mm stainless steel PU = 2 coupling joint</p>	<p>20321 14,40 €</p>
 	<p>Pulling eyelet Ø 8 mm stainless steel, RTG Ø 6 mm thread</p>	<p>30208 4,90 €</p>
 	<p>Pulling eyelet-set Ø 7 mm stainless steel, RTG Ø 6 mm thread</p>	<p>20487 9,40 €</p>
 	<p>Swivel joint Ø 11 mm stainless steel, RTG Ø 6 mm thread</p>	<p>20251 24,70 €</p>

All prices are ex-works 5303 - Thalgau - AUSTRIA - plus statutory taxes and duties. All price information represents non-binding price recommendations. Pricelist 2024. All illustrations are symbol photos. Typing and printing errors reserved.

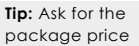
Item		Item no.	Rec. trade price
	 Pull loop , stainless steel rope Ø 1,5 mm (loop length 75 mm) RTG Ø 6 mm thread	20428	7,10 €
	 Pull loop 2 mm , stainless steel rope Ø 2 mm (loop length 35 mm) RTG Ø 6 mm thread	20427	7,10 €
	Special glue 3 g	30050	8,40 €
	2 components special glue 24 ml	30067	20,60 €
	Pulling grip for fiberglass rod Ø 3 – 12 mm	30070	6,40 €
	Extendable standing feet incl. storage compartment for reel Ø 330 mm and Ø 530 mm PU = 1 piece	20278	43,30 €
	GF6 Profi-set steel reel Ø 530 mm for Ø 6 mm incl. double run-out system with extendable standing feet and storage compartment for accessories CDP/powder coated	20403	231,00 €
	GF6 Standard-set steel reel Ø 530 mm for Ø 6 mm incl. double run-out system and parking brake CDP/powder coated	20300	171,00 €
	 Cable lubricant SPRAY 400 ml Cable lubricant FOAM 400 ml (with folding spray tube) Non inflammable Cable lubricant GEL 1000 g Cable lubricant GEL 250 g 	20523 20522 30064 30467	8,20 € 7,10 € 8,90 € 4,40 €

Information

GF4.5 and GF6 Fiberglass rods Ø 4,5 mm, Ø 6 mm, the RUNPOSTICKS and the entire accessories are compatible! s.p.24

FLEXIBLE LEADING HEAD-SET



Flexible leading head-set: can be adapted on roller, shackle and starting head Ø 20 mm and Ø 30 mm.



Connectivity options:

The sticks can each be extended by 1 m and adapted as flexible leading head-set on fiberglass rods Ø 7,5 mm / 9 mm and 11 mm to get around narrow bends. It is additionally possible to screw on accessories such as the roller or guiding head with swivel at the tip.

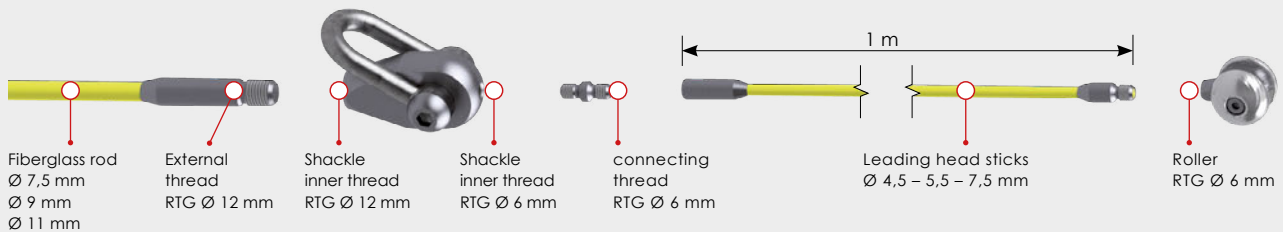

Application example: flexible leading head-set

The problem situation:

Fiberglass rod Ø 7,5 mm, Ø 9 mm or Ø 11 mm stops at to narrow radii from of the tube.

Solution:

With leading head-set, taper off through the flexible sticks Ø 4,5 mm (yellow), Ø 5,5 mm (black) oder Ø 7,5 mm (red). Thereby it makes it possible to get over the last bend or radii.

Tooltip:

Additional manual haul support possible.

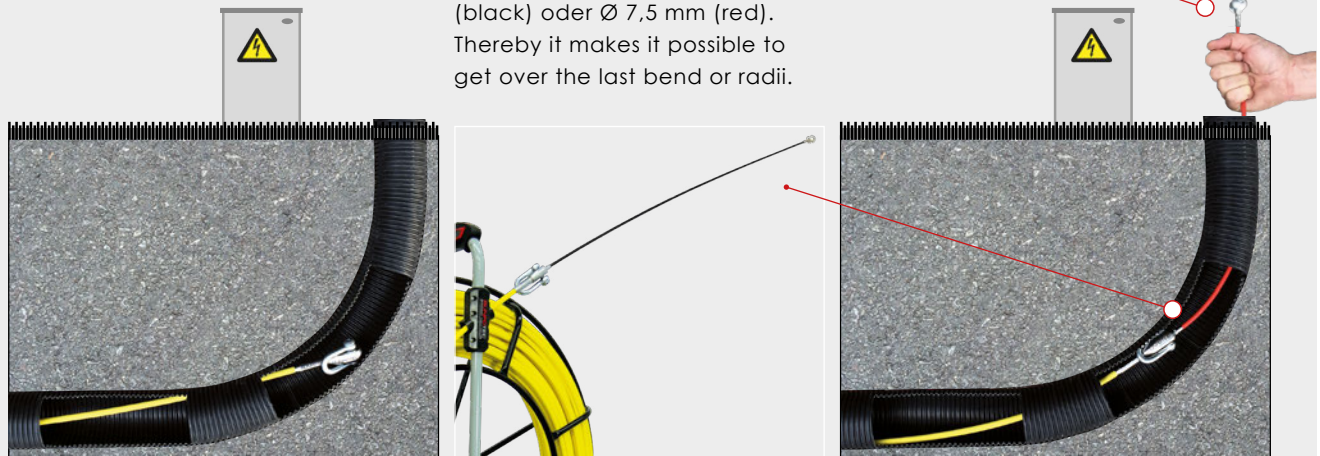

Item		Item. no.	Rec. trade price
	Flexible leading head-set – 13 parts Included accessories of flexible leading head-set with RTG Ø 6 mm thread: 2 x Sticks Ø 4,5 mm, 2 x Sticks Ø 5,5 mm, 2 x Sticks Ø 7,5 mm, 1 x RG7 - Guiding head with front thread, Roller Ø 24 mm, 3 x Coupling thread, 1 x Blindcap, 1 x Starting head Ø 20 mm	20442	102,00 €

GF7.5 / GF9 Fiberglass rod Ø 7,5 / 9 mm – Cable pulling system

VIDEO



GF7.5/GF9

KG 400
Ø 7,5 mm

KG 460
Ø 9 mm

RC2 –
Inspection camera
COMPATIBLE



- Ergonomic holding and carrying handle
- Autom. run-out brake
- Lateral parking brake
- Meter counter with hardened thumb wheel
- Quick run with mounted rollers
- Mobile reel
- CDP / powder-coated
- 2 x threaded bolts (for roller or starting head)



Rod tip: Shakel, stainless steel, RTG Ø 12 mm thread, screwed to strang



Rod end: Ending joint, stainless steel, RTG Ø 12 mm thread

Double run-out-system
(Quick run and automatic run-out brake)

Quick run with mounted rollers

Automatic run-out brake

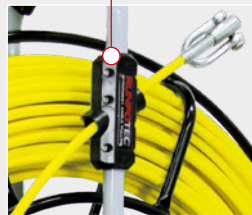
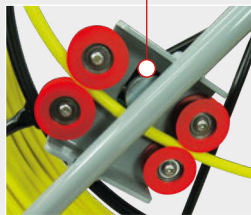

Meter counter with hardened thumb wheel

6-digit roller counter with meter and 10 cm steps







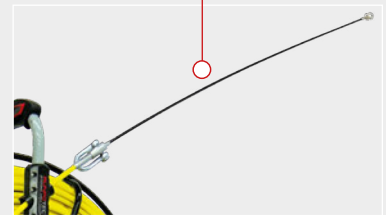

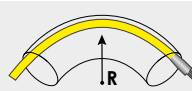
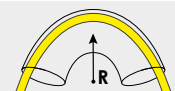
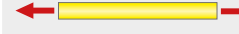
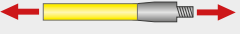

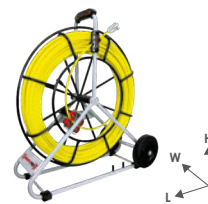
Additional option:
Adaptable leading heads

13-parts flexible leading head-set see page 42

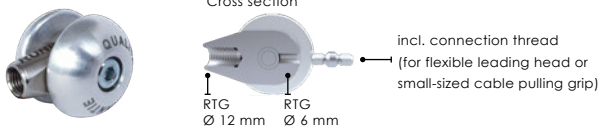
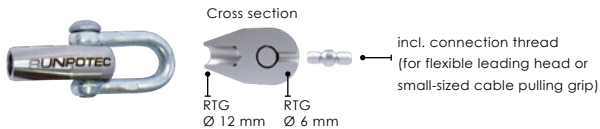
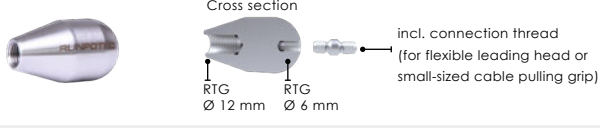
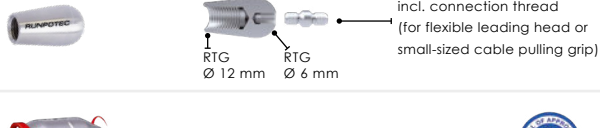













Rod	Rec. pipe diameter	Bending radius w. e. joint	Bending radius rod	Breaking load	Total breaking load
Ø					
7,5 mm	50 – 120 mm	500 mm	115 mm	3400 kg	400 kg
9 mm	60 – 200 mm	620 mm	140 mm	4500 kg	460 kg

Item		Length	Item. no.	Rec. trade price
	<p>GF7.5 Fiberglass rod Ø 7,5 mm, mobile, Ø 730 mm</p> <ul style="list-style-type: none"> Meter counter with hardened thumb wheel Double run-out-system with parking brake Rod tip with shackle Robust CDP / powder-coated steel reel <p>Dimensions: L 830 mm W 400 mm H 900 mm</p>	40 m	10076	455,00 €
		50 m	10077	477,00 €
		60 m	10078	497,00 €
		80 m	10079	539,00 €
		100 m	10080	576,00 €
		120 m	10091	610,00 €
	<p>GF9 Fiberglass rod Ø 9 mm, mobile, Ø 730 mm</p> <ul style="list-style-type: none"> Meter counter with hardened thumb wheel Double run-out-system with parking brake Rod tip with shackle Robust CDP / powder-coated steel reel <p>Dimensions: L 830 mm W 400 mm H 730 mm</p>	40 m	10081	458,00 €
		50 m	10082	489,00 €
		60 m	10083	519,00 €
		80 m	10084	576,00 €
		100 m	10085	624,00 €
		120 m	10086	656,00 €
150 m	10110	747,00 €		

Item	Item no.	Rec. trade price
	<p>GF7.5 Replacement fiberglass rod Ø 7.5 mm, ending joints on both sides RTG Ø 12 mm thread</p> <p>40 m 50 m 60 m 80 m 100 m 120 m</p>	<p>20368 130,00 € 20369 146,00 € 20370 166,00 € 20371 207,00 € 20372 244,00 € 20414 281,00 €</p>
	<p>GF9 Replacement fiberglass rod Ø 9 mm, ending joints on both sides RTG Ø 12 mm thread</p> <p>40 m 50 m 60 m 80 m 100 m 120 m 150 m</p>	<p>20373 144,00 € 20374 171,00 € 20375 199,00 € 20376 247,00 € 20377 309,00 € 20378 350,00 € 20562 416,00 €</p>
	<p>Roller Ø 50 mm stainless steel / aluminium RTG Ø 12 mm thread incl. connection thread</p>	<p>20382 40,20 €</p>
	<p>Shackle stainless steel, galvanised steel RTG Ø 12 mm thread incl. connection thread</p>	<p>20383 27,80 €</p>
	<p>Starting head Ø 30 mm stainless steel, RTG Ø 12 mm thread incl. connection thread</p>	<p>20404 25,80 €</p>
	<p>Starting head Ø 20 mm stainless steel, RTG Ø 12 mm thread incl. connection thread</p>	<p>20409 23,70 €</p>
 	<p>Swivel joint stainless steel, RTG Ø 12 mm thread</p>	<p>20387 36,10 €</p>
	<p>Meter counter for steel reel Ø 730 mm incl. mounting-set</p>	<p>20461 109,00 €</p>
	<p>Run-out rollers-set (set of 4) for reel Ø 730 mm and Ø 1000 mm incl. fixing-set</p>	<p>20646 31,90 €</p>
 <p>Repair manual, www.runpotec.com</p> 	<p>GF7.5 / GF9 Repairing-kit 1 x 2K-special glue 24 ml 2 x Ending joints, RTG Ø 12 mm 1 x Coupling joint for Ø 7,5 mm for Ø 9 mm</p>	<p>20384 47,40 € 20385 53,00 €</p>

All prices are ex-works 5303 - Thalgau - AUSTRIA - plus statutory taxes and duties. All price information represents non-binding price recommendations. Pricelist 2024. All illustrations are symbol photos. Typing and printing errors reserved.

Item	Item no.	Rec. trade price
  <p>GF7.5 / GF9 Ending joint stainless steel, RTG Ø 12 mm thread for Ø 7,5 mm for Ø 9 mm</p>	<p>20381 20379</p>	<p>10,30 € 10,30 €</p>
  <p>GF7.5 / GF9 Coupling joint stainless steel for Ø 7,5 mm for Ø 9 mm</p>	<p>20380 20412</p>	<p>14,40 € 14,40 €</p>
  <p>Blind cap-set stainless steel, RTG Ø 6 mm thread PU = 3 blind cap-set</p>	<p>20443</p>	<p>6,00 €</p>
 <p>2 components special glue 24 ml</p>	<p>30067</p>	<p>20,60 €</p>
 <p>GF7.5 / GF9 Steel reel Ø 730 mm, mobile for Ø 7,5 mm and 9 mm incl. double run-out system and meter counter CDP/powder coated</p>	<p>20405</p>	<p>330,00 €</p>
  <p>Cable pulling grip with swivel stainless steel, RTG Ø 12 mm thread Ø 9 – 15 mm Ø 15 – 19 mm Ø 19 – 25 mm Ø 25 – 31 mm</p> <p>Information: Cable pulling grip range see page 33</p>	<p>20266 20267 20268 20269</p>	<p>41,20 € 43,30 € 44,30 € 46,40 €</p>
 <p>Flexible leading head-set - 13 parts, RUNPOSTICKS including accessories stowed in storage bag</p> <p>Information: Flexible leading head-set see page 42</p>	<p>20442</p>	<p>102,00 €</p>
 <div style="border: 1px solid red; padding: 2px; display: inline-block;">NON-INFLAMMABLE</div> <p>Cable lubricant SPRAY 400 ml Cable lubricant FOAM 400 ml (with folding spray tube) Non inflammable</p> <p>Tip: Ask for the package price</p> <p>Cable lubricant GEL 1000 g Cable lubricant GEL 250 g</p>	<p>20523 20522 30064 30467</p>	<p>8,20 € 7,10 € 8,90 € 4,40 €</p>
 <p>Cable lubricant LIQUID 1000 ml</p>	<p>30063</p>	<p>7,40 €</p>

RC2 Inspection camera compatible

The RC2 Inspection camera – is also compatible with GF7.5, GF9, GF11 and GF15 Fiberglass rod Ø 7,5 mm, Ø 9 mm, Ø 11 mm and Ø 15 mm. This allows the coupling thread RTG Ø 12 mm to RTG Ø 6 mm thread. See page 18

GF11 Fiberglass rod Ø 11 mm – Cable pulling system



- Ergonomic holding and carrying handel
- Autom. Run-out brake
- Lateral parking brake
- Meter counter with hardened thumb wheel
- Quick run with mounted rollers
- Mobile reel CDP/ powder-coated
- 2 x threaded bolts (for roller or starting head)



Rod tip: Shakel, stainless steel, RTG Ø 12 mm thread, screwed to strang



Rod end: Ending joint, stainless steel, RTG Ø 12 mm thread

Double run-out-system (Quick run and automatic run-out brake)

Quick run with mounted rollers

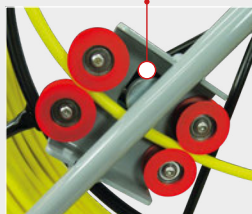

Automatic run-out brake



Meter counter with hardened thumb wheel

6-digit roller counter with meter and 10 cm steps



Additional option: Adaptable leading heads



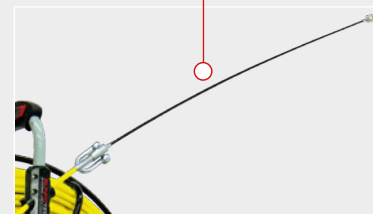







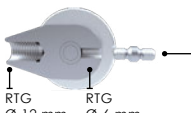

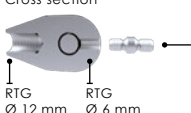

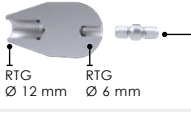

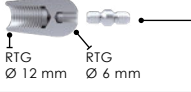





13-parts flexible leading head-set see page 42

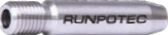

Rod	Rec. pipe diameter	Bending radius w. e. joint	Bending radius rod	Breaking load	Total breaking load
Ø					
11 mm	80 – 250 mm	770 mm	210 mm	6200 kg	580 kg

Item		Length	Item no.	Rec. trade price
	GF11 Fiberglass rod Ø 11 mm, mobile, Ø 1000 mm	100 m	10092	758,00 €
	• Meter counter with hardened thumb wheel	120 m	10093	831,00 €
	• Double run-out-system with parking brake	150 m	10094	936,00 €
	• Rod tip with shackle	200 m	10095	1118,00 €
	• Robust CDP / powder-coated steel reel	250 m	10096	1306,00 €
	Dimensions: L 1140 mm W 550 mm H 1200 mm	300 m	10097	1410,00 €
	GF11 Replacement fiberglass rod Ø 11 mm	100 m	20386	523,00 €
	with ending joints on both sides	120 m	20417	535,00 €
	RTG Ø 12 mm thread	150 m	20418	665,00 €
	Dimensions: Ø 1060 mm H 245 mm	200 m	20419	832,00 €
		250 m	20420	983,00 €
		300 m	20421	1144,00 €

All prices are ex-works 5303 - Thalgau - AUSTRIA - plus statutory taxes and duties. All price information represents non-binding price recommendations. Pricelist 2024. All illustrations are symbol photos. Typing and printing errors reserved.

Item	Item no.	Rec. trade price
 <p>Cross section</p>  <p>incl. connection thread (for flexible leading head or small-sized cable pulling grip)</p> <p>RTG Ø 12 mm RTG Ø 6 mm</p>	20382	40,20 €
 <p>Cross section</p>  <p>incl. connection thread (for flexible leading head or small-sized cable pulling grip)</p> <p>RTG Ø 12 mm RTG Ø 6 mm</p>	20383	27,80 €
 <p>Cross section</p>  <p>incl. connection thread (for flexible leading head or small-sized cable pulling grip)</p> <p>RTG Ø 12 mm RTG Ø 6 mm</p>	20404	25,80 €
 <p>Cross section</p>  <p>incl. connection thread (for flexible leading head or small-sized cable pulling grip)</p> <p>RTG Ø 12 mm RTG Ø 6 mm</p>	20409	23,70 €
 	20387	36,10 €
	20462	115,00 €
	20646	31,90 €
    <p>Repair manual, www.runpotec.com</p>	20424	61,00 €
 	20422	12,40 €
 	20423	17,50 €
 	20443	6,00 €
	30067	20,60 €
	20416	411,00 €

Information



Compatible cable pulling grip range see page 33.



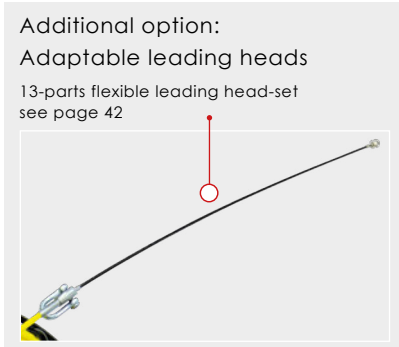
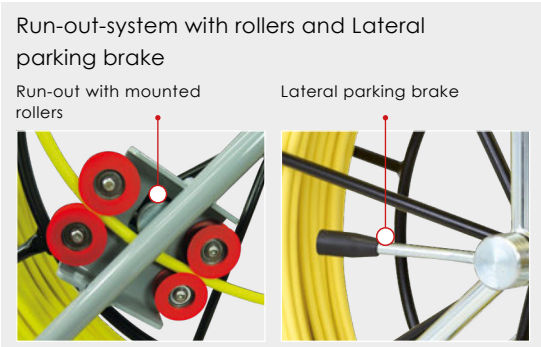
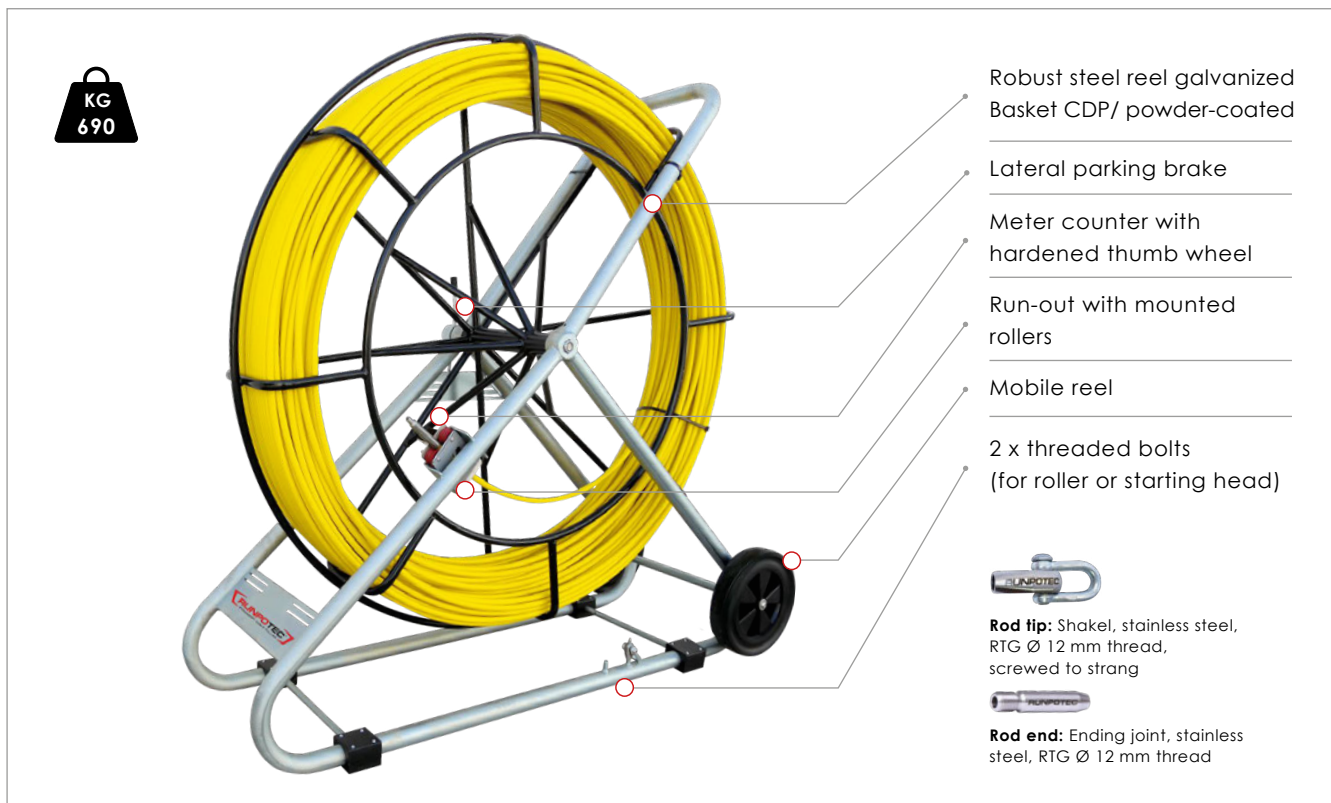









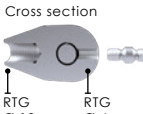

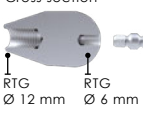



GF15 Fiberglass rod Ø 15 mm – Cable pulling system



Rod	Rec. pipe diameter	Bending radius w. e. joint	Bending radius rod	Breaking load	Total breaking load
Ø					
15 mm	180 – 450 mm	1200 mm	800 mm	14500 kg	690 kg

Item		Length	Item no.	Rec. trade price
	GF15 Fiberglass rod Ø 15 mm, mobile, Ø 1400 mm	150 m	10099	2547,00 €
	• Meter counter with hardened thumb wheel	200 m	10100	2808,00 €
	• Run-out-system with rollers and lateral parking brake	250 m	10101	3093,00 €
	• Rod tip with shackle	300 m	10102	3354,00 €
	• Robust steel reel - galvanized	350 m	10103	3639,00 €
	• Reel basket - CDP / powder-coated	400 m	10104	3933,00 €
Dimensions: L 1558 mm W 628 mm H 1593 mm				
	GF15 Replacement fiberglass rod Ø 15 mm	150 m	20491	1029,00 €
	with ending joints on both sides	200 m	20492	1272,00 €
	RTG Ø 12 mm thread	250 m	20493	1545,00 €
	Dimensions: Ø 1470 mm H 334 mm	300 m	20494	1815,00 €
		350 m	20495	2081,00 €
		400 m	20496	2394,00 €

All prices are ex-works 5303 - Thalgau - AUSTRIA - plus statutory taxes and duties. All price information represents non-binding price recommendations. Pricelist 2024. All illustrations are symbol photos. Typing and printing errors reserved.

Item	Item no.	Rec. trade price
 <p>Cross section</p>  <p>incl. Connection thread (for flexible leading head or small-sized cable pulling grip)</p> <p>RTG Ø 12 mm RTG Ø 6 mm</p>	20382	40,20 €
 <p>Cross section</p>  <p>incl. Connection thread (for flexible leading head or small-sized cable pulling grip)</p> <p>RTG Ø 12 mm RTG Ø 6 mm</p>	20383	27,80 €
 <p>Cross section</p>  <p>incl. Connection thread (for flexible leading head or small-sized cable pulling grip)</p> <p>RTG Ø 12 mm RTG Ø 6 mm</p>	20404	25,80 €
 <p>Cross section</p>  <p>incl. Connection thread (for flexible leading head or small-sized cable pulling grip)</p> <p>RTG Ø 12 mm RTG Ø 6 mm</p>	20409	23,70 €
 	20387	36,10 €
  <p>Repair manual, www.runpotec.com</p>	20489	177,00 €
 	20490	57,00 €
 	20498	58,00 €
	30067	20,60 €
	20497	1639,00 €
 <p>Information: Flexible leading head-set see page 42</p>	20442	102,00 €

Information



Compatible cable pulling grip range see page 33.

CW 800 E Capstan winch for horizontal cable pulling

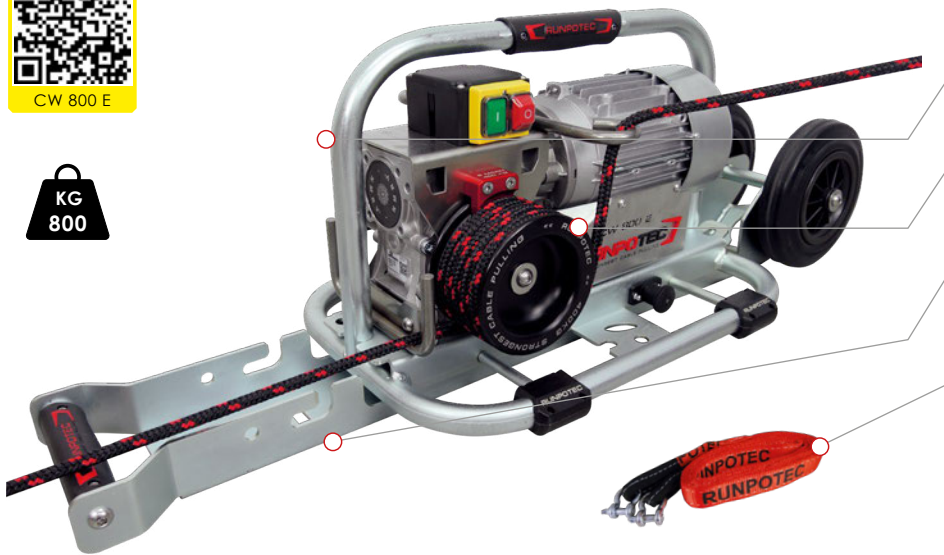

EXTRA STRONG, provides the pulling power of 8 – 10 people

Rope pulley (capstan) small
Ø 55 mm, 4 m/min., max. 800 kg

Rope pulley (capstan) large
Ø 110 mm, 8 m/min., max. 400 kg

Trolley mounting rail with
2 wheels and many mounting
options





Belt (3 m) with loops including
2 fastening shackles

SPECIAL OFFER

CW 800 E + 1x cable pulling grip + 1x cable guide roller – shaft for free! See page 64

The CW 800 E Capstan winch is ideal for pulling one or more cables horizontally. One person is enough to move at either 4 m/min | max. 800 kg or 8 m/min | max. 400 kg to pull the cables. The CW 800 E can be attached to objects using the mounting holes, with the strap, or on the trolley mounting rail using the two fixing bolts. The trolley mounting rail itself can be attached to the trailer hitch of cars through the special coupling opening, and mounted horizontally or vertically.

Safety notice: Not suitable for vertical cable pulling, must not be used to carry or lift loads or persons.

Item	Item no.	Rec. trade price
 <div style="display: flex; align-items: center;"> <div style="margin-right: 10px;"> <p>CW 800 E Capstan winch for horizontal cable pulling incl. steel trolley mounting rail and 3 m strap Total weight: 41,5 kg Motor connection: 230 V 50 Hz Motor power: 0,75 kWh 5,1 A Dimensions: L 990 mm W 375 mm H 360 mm</p> </div>  </div>	10138	2368,00 €
 <div style="display: flex; align-items: center;"> <div style="margin-right: 10px;"> <p>CW 800 E Capstan winch for horizontal cable pulling Total weight: 32 kg Motor connection: 230 V 50 Hz Motor power: 0,75 kWh 5,1 A Dimensions: L 510 mm W 375 mm H 350 mm</p> </div>  </div>	10148	2270,00 €
 <p>Trolley mounting rail for capstan winch CW 800 E - easy to transport due to wheels and ergonomic handle, versatile mounting options - steel galvanised</p>	20622	143,00 €
 <p>Capstan head Spare part for CW 800 E capstan winch Diameter Ø 55 mm – Tension load 800 kg Diameter Ø 110 mm – Tension load 400 kg</p>	20658 20657	162,00 € 196,00 €
 <p>Rope guide jaw-set Spare part for CW 800 E capstan winch Ø 55 mm / Ø 110 mm</p>	20683	114,00 €

The portable CW 800 E Capstan winch can be fastened in various ways:

The housing can be screwed to the floor **1**, or with a strap and suitable accessories through the attachment eye **2** fixed to a solid object (e.g., tree). You can also fix the housing on the trolley **3** by means of locking bolts **4** on the rail. The trolley itself can be screwed down, hung directly on a trailer hitch **5** or fixed with a strap through the attachment eye to a fixed object.

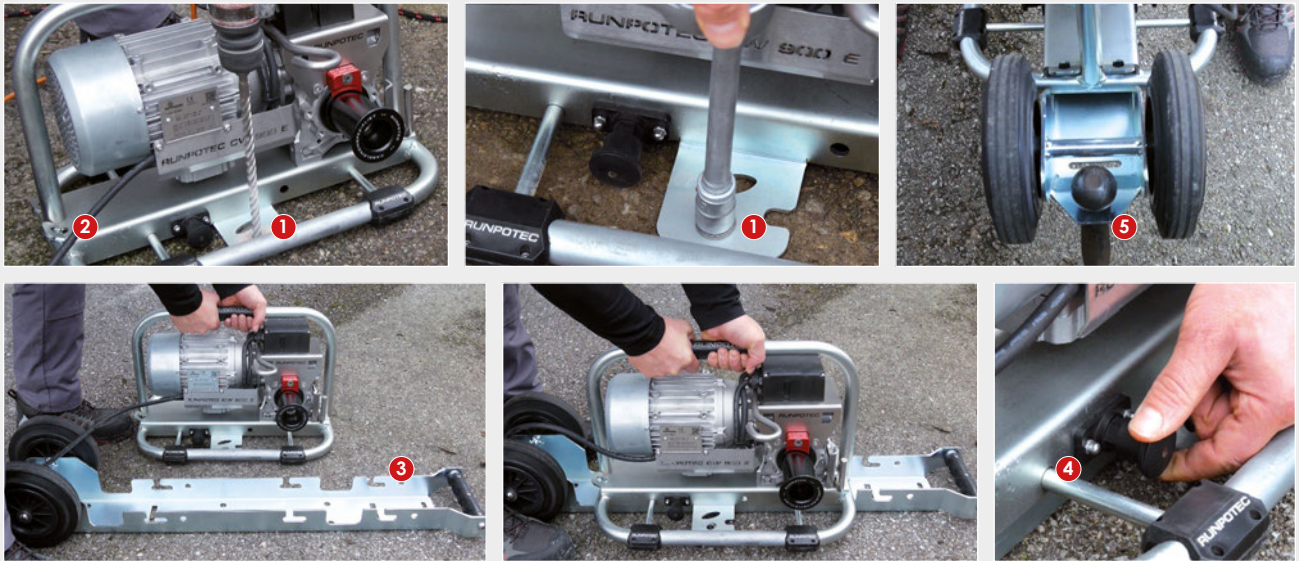

Application of the CW 800 E Capstan winch:

The cable to be pulled is connected, preferably with a connection swirl with swivel, with the pull rope.



The towing rope is guided past inside the rope guide pin **6**. Wrap the towing rope at least 3 times around the capstan winch (**7** or **8**) and then lead out through the rope guide **9**. Keep the towing rope tight, so that it does not get tangled up.



The operator stands next to the capstan winch with a sufficient safety distance and pulls with little effort at a 90° angle to the pulling direction on the pull rope. The effort should only be so strong until the feed rate is reached. Very strong pulling does not increase the pulling power of the capstan winch!



POLYESTER CABLE PULLING ROPE incl. steel reel



KG
1100

Steel reel 514/70



KG
1640

Steel reel 770/98



KG
2180

Steel reel 770/192

The **polyester pulling rope** Ø 10 mm and Ø 12 mm is suitable for horizontal cable pull with the CW 800 E Capstan winch. For the horizontal cable pull, the use of the connection swivel with twist compensation is recommended, it reduces the frictional resistance and thus protects the cable and pull-in system. The steel reel enables controlled winding and unwinding of the rope.



Safety notice: Not suitable for the vertical cable pull, must not be used to bear/lift loads or people.

*Pulling rope Ø 8 mm is not suitable for pulling the cable with the CW 800 E Capstan winch.

Item	Rope Ø	Total breaking load	Length	Reel basket Ø	Internal reel basket	Item no.	Rec. trade price
 <p>Pulling rope incl. steel reel and parking brake CDP / powder coated Spliced loops at the start and end of the rope</p>	* 8 mm	1100 kg	120 m	514 mm	70 mm	10169	380,00 €
	10 mm	1640 kg	120 m	514 mm	70 mm	10167	428,00 €
			200 m	770 mm	98 mm	10168	582,00 €
	12 mm	2180 kg	150 m	770 mm	98 mm	10120	606,00 €
			200 m	770 mm	98 mm	10121	677,00 €
			300 m	770 mm	192 mm	10122	821,00 €
350 m			770 mm	192 mm	10123	916,00 €	

Item	Rope Ø	Total breaking load	Length	Reel basket Ø	Drum height	Item no.	Rec. trade price
 <p>Pulling rope on drum Spliced loops at the start and end of the rope</p>	* 8 mm	1100 kg	120 m	230 mm	217 mm	20621	131,00 €
	10 mm	1640 kg	120 m	250 mm	300 mm	20619	178,00 €
			200 m	300 mm	300 mm	20620	262,00 €
	12 mm	2180 kg	150 m	300 mm	345 mm	20615	272,00 €
			200 m	350 mm	330 mm	20616	356,00 €
			300 m	400 mm	380 mm	20617	510,00 €
350 m			400 mm	430 mm	20618	595,00 €	

Item	Reel basket Ø	Internal reel basket	Item no.	Rec. trade price
 <p>Rope reel 514 Rope reel 770 small Rope reel 770 wide</p>	514 mm	70 mm	20527	259,00 €
	770 mm	98 mm	20526	335,00 €
	770 mm	192 mm	20525	340,00 €

Item	Weave length	Total breaking load	Ø	Item no.	Rec. trade price
 <p>← Weave length →</p> <p>Application example</p>  <p>Optimal combination: Pulling rope – connection swirl with swivel – cable pulling grip</p>	600 mm	1019 kg	Ø 10 – 15 mm	20661	41,20 €
	600 mm	2080 kg	Ø 15 – 20 mm	20662	43,30 €
	600 mm	2080 kg	Ø 20 – 25 mm	20663	44,30 €
	1000 mm	2080 kg	Ø 25 – 30 mm	20664	48,40 €
	1250 mm	3059 kg	Ø 30 – 40 mm	20665	55,00 €
	1250 mm	4078 kg	Ø 40 – 50 mm	20666	60,00 €
	1500 mm	4996 kg	Ø 50 – 60 mm	20667	70,00 €
	1500 mm	4996 kg	Ø 60 – 70 mm	20668	82,00 €
	1500 mm	4996 kg	Ø 70 – 85 mm	20669	96,00 €
	1500 mm	5812 kg	Ø 85 – 100 mm	20670	109,00 €

ACCESSORIES – Optimal in combination with pulling rope, cable pulling grip and CW 800 E Capstan winch

Item	Item no.	Rec. trade price
 <p>Connection swirl with swivel Ø 30 mm L 144 mm, stainless steel</p>	10176	196,00 €

All prices are ex-works 5303 - Thalgau - AUSTRIA - plus statutory taxes and duties. All price information represents non-binding price recommendations. Pricelist 2024. All illustrations are symbol photos. Typing and printing errors reserved.

CABLE GUIDE ROLLER

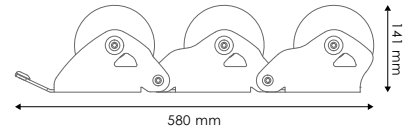
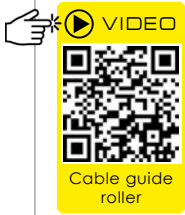

Cable guide roller can be used for shafts, cable trays, pillars, etc. to gently pull cables around corners with the least possible resistance. The high-quality aluminum heavy-duty rollers with integrated ball bearings and the stable powder-coated steel frame guarantee a long service life.

0 degrees



60 degrees



90 degrees



120 degrees



180 degrees



Item		Item no.	Rec. trade price
	Cable guide roller – chain – 3 roll links Universally applicable for shafts, cable routes, pillars etc., load capacity 4.500 kg Roller-Ø 130 mm, max. cable diameter: Ø 100 mm Aluminium heavy-duty rollers, frame: CDP and powder coated	10166	241,00 €
	Cable guide roller – chain – 4 roll links Description see 3 roll links	10199	321,00 €
	Cable guide roller – chain – 5 roll links Description see 3 roll links	10200	402,00 €
	Cable guide roller – chain – 6 roll links Description see 3 roll links	10201	481,00 €
 	Cable guide roller – shaft for shaft inlets or outlets , load capacity 4.500 kg Roller-Ø 130 mm, max. cable diameter: Ø 100 mm Aluminium heavy-duty rollers, frame: CDP and powder coated	10157	82,00 €
 	Cable guide roller – shaft inside edge for shafts, shoulders or steps, load capacity 4.500 kg Roller-Ø 130 mm, max. cable diameter: Ø 100 mm Aluminium heavy-duty rollers, frame: CDP and powder coated	10156	82,00 €
 	Cable guide roller – 90 degrees for corners and edges, load capacity 4.500 kg Roller-Ø 130 mm, max. cable diameter: Ø 100 mm Aluminium heavy-duty rollers, frame: CDP and powder coated, ergonomic aluminium carrying handle	10153	157,00 €
 	Cable guide roller – 90 degrees 3 R for corners and edges, load capacity 2.500 kg Roller-Ø 130 mm, max. cable diameter: Ø 100 mm Aluminium heavy-duty rollers, frame: CDP and powder coated, ergonomic aluminium carrying handle	10189	247,00 €

RUNPOTEC SYSTEM CASE

W-BOXX® | Sortimo® COMPATIBLE

Stackable with fast click system



RUNPOTEC system case with UNIVERSAL, RC2 Inspections camera, RT 2008 and RM35 case insert is perfect for storing and transporting of the previously mentioned RUNPOTEC products. One advantage is the fast click system, which allows the boxes to be connected to each other without effort and disconnected again at the push of a button. The boxes are easily stackable thanks to the quick click system. The W-BOXX can be seamlessly integrated into the Sortimo Globelyst system. The high-quality and lightweight W-BOXX made of PP plastic is impact and shock resistant and splash-proof.

UNIVERSAL case insert



symbol photo without content

RC2 Inspection camera case insert



symbol photo without content

RT 2008 case insert



symbol photo without content

RM35 case insert



symbol photo without content

Item		Item no.	Rec. trade price
		RUNPOTEC system case with case insert for RT 2008	20611 56,00 €
		RUNPOTEC system case with case insert for RC2 Inspection camera	20612 56,00 €
		RUNPOTEC system case with UNIVERSAL case insert For X BOARD XB 300 + multifunction mandrel + RP5 + small parts	20613 56,00 €
		RUNPOTEC system case with case insert for RM35 For RM35 including accessories	20708 56,00 €

All prices are ex-works 5303 - Thalgau - AUSTRIA - plus statutory taxes and duties. All price information represents non-binding price recommendations. Pricelist 2024. All illustrations are symbol photos. Typing and printing errors reserved.

RM80 Laser distance meter



POWERFUL LASER
up to 80 m



Front laser



Carrying loop



Protective case



Technical data

Measuring range	0,05 m – 80 m	IP rating	IP 54
Measuring tolerance	± 1,5 mm auf 80m	Laser type	620 – 690 nm, < 1mW
Laser class	II	Dimensions (mm)	121 x 45 x 25
Measure range of tilt sensor	360°	Battery	AAA 2 x 1,5 V
Accuracy of tilt sensor	± 0,3 ° *	Battery life	up to 5000 measurings

* This is the typical value. Depending on the enviornment the deviation can rise slightly.

Technical data

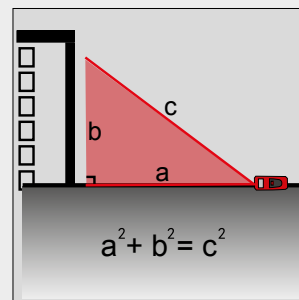
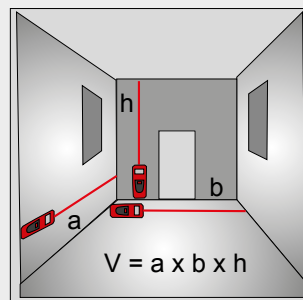
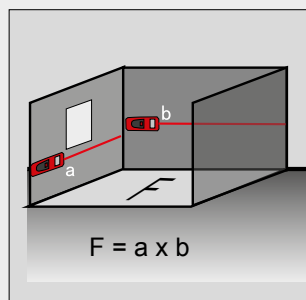
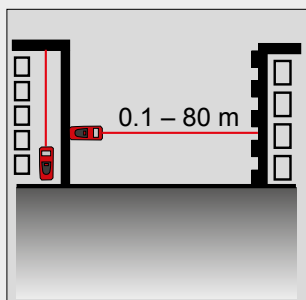

Item		Item no.	Rec. trade price
	<p>RM80 Laser distance meter</p> <ul style="list-style-type: none"> Measures up to 80 m distance Incl. angle- and inclination display Extensive calculation functions Storage of 99 measurings Incl. protective case with belt loop 	10108	118,00€

METAL SPIRAL with special eyelet









Beginning: Special eyelet Ø 6 mm, pressed onto strand



Ending: Special eyelet Ø 6 mm, pressed onto strand



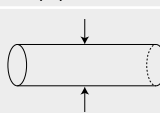
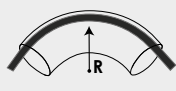

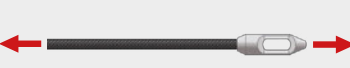
 3 times offset wound metal spiral

Rod	Rec. pipe diameter	Bending radius rod	Total breaking load - ending	Total breaking load - beginning
Ø				
4 mm	16 - 32 mm	25 mm	120 Kg	120 Kg

Item		Length	Item no.	Rec. trade price
	Metal spiral Ø 4 mm	10 m	30010	14,40 €
	with special eyelet	15 m	30011	21,60 €
	Total breaking load: 120 kg	20 m	30012	26,80 €
		25 m	30013	33,00 €
		30 m	30014	40,20 €

NYLON FISH TAPE









Beginning: starting spinner with eyelet Ø 6 mm, pressed onto strand



Ending: Special eyelet Ø 6 mm, pressed onto strand

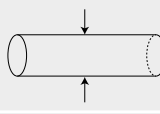

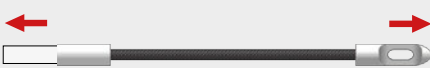
Rod	Rec. pipe diameter	Bending radius rod	TBL - ending	Total breaking load - beginning
Ø				
4 mm	16 - 25 mm	25 mm	110 Kg	110 Kg

Item		Length	Item no.	Rec. trade price
	Nylon fish tape Ø 4 mm	5 m	20060	7,80 €
	Total breaking load: 110 kg	10 m	20061	9,30 €
		15 m	20062	11,30 €
		20 m	20063	12,40 €
		25 m	20064	14,40 €
		30 m	20065	15,50 €

All prices are ex-works 5303 - Thalgau - AUSTRIA - plus statutory taxes and duties. All price information represents non-binding price recommendations. Pricelist 2024. All illustrations are symbol photos. Typing and printing errors reserved.

Page	EAN-Code	Item no.	Rec. trade price
30	9120045476163	10000	308,00 €
22	9120045472806	10013	140,00 €
22	9120045472813	10014	162,00 €
24	9120045473094	10016	119,00 €
24	9120045473100	10020	139,00 €
25	9120045473186	10042	24,70 €
25	9120045473179	10043	19,00 €
25	9120045473162	10044	20,00 €
25	9120045473155	10045	20,00 €
36	9120045473520	10047	341,00 €
36	9120045473537	10048	269,00 €
36	9120045473544	10050	396,00 €
36	9120045473551	10051	325,00 €
36	9120045473568	10052	260,00 €
36	9120045473575	10054	192,00 €
36	9120045473582	10055	287,00 €
36	9120045473599	10056	218,00 €
36	9120045473605	10057	315,00 €
34	9120045473612	10058	244,00 €
39	9120045473629	10059	321,00 €
39	9120045473636	10060	265,00 €
39	9120045473643	10061	349,00 €
39	9120045473650	10062	293,00 €
39	9120045473667	10063	381,00 €
39	9120045473674	10064	325,00 €
39	9120045473681	10065	448,00 €
39	9120045473704	10066	390,00 €
43	9120045473858	10076	455,00 €
43	9120045473865	10077	477,00 €
43	9120045473872	10078	497,00 €
43	9120045473889	10079	539,00 €
43	9120045473896	10080	576,00 €
43	9120045473902	10081	458,00 €
43	9120045473919	10082	489,00 €
43	9120045473926	10083	519,00 €
43	9120045473933	10084	576,00 €
43	9120045473940	10085	624,00 €
43	9120045473957	10086	656,00 €
43	9120045474428	10091	610,00 €
46	9120045474480	10092	758,00 €
46	9120045474497	10093	831,00 €
46	9120045474503	10094	936,00 €
46	9120045474510	10095	1 118,00 €
46	9120045474527	10096	1 306,00 €
46	9120045474534	10097	1 410,00 €
48	9120045474749	10099	2 547,00 €

Page	EAN-Code	Item no.	Rec. trade price
48	9120045474756	10100	2 808,00 €
48	9120045474763	10101	3 093,00 €
48	9120045474770	10102	3 354,00 €
48	9120045474787	10103	3 639,00 €
48	9120045474794	10104	3 933,00 €
55	9120045474893	10108	118,00 €
43	9120045475210	10110	747,00 €
52	9120045475364	10120	606,00 €
52	9120045475371	10121	677,00 €
52	9120045475388	10122	821,00 €
52	9120045475395	10123	916,00 €
13	9120045475647	10134	199,00 €
13	9120045475654	10135	230,00 €
3,10	9120045475616	10136	234,00 €
8	9120045475623	10137	114,40 €
50	9120045475630	10138	2 368,00 €
18	9120045475555	10139	524,00 €
18	9120045475562	10140	566,00 €
18	9120045475579	10141	608,00 €
16	9120045475609	10142	864,00 €
14	9120045475708	10147	139,00 €
50	9120045475715	10148	2 270,00 €
53	9120045476361	10153	157,00 €
32	9120045475777	10154	42,20 €
53	9120045476378	10156	82,00 €
53	9120045476385	10157	82,00 €
32	9120045475821	10159	42,20 €
14	9120045476439	10161	2 153,00 €
14	9120045476446	10162	2 688,00 €
14	9120045476453	10163	2 730,00 €
14	9120045476460	10164	2 771,00 €
53	9120045476521	10166	241,00 €
52	9120045475906	10167	428,00 €
52	9120045475913	10168	582,00 €
52	9120045475920	10169	380,00 €
9	9120045476545	10170	195,00 €
9,23	9120045476552	10171	314,00 €
6	9120045476583	10172	349,00 €
9	9120045475685	10174	152,00 €
34,52	9120045475999	10176	196,00 €
7	9120045476910	10184	489,00 €
3,11	9120045477009	10187	310,00 €
53	9120045477047	10189	247,00 €
26	9120045476729	10192	184,00 €
4,26	9120045477122	10193	169,00 €
26	9120045477139	10195	219,00 €

Page	EAN-Code	Item no.	Rec. trade price
26	9120045477146	10196	117,50 €
26	9120045477153	10197	131,00 €
26	9120045477160	10198	156,50 €
53	9120045477214	10199	321,00 €
53	9120045477221	10200	402,00 €
53	9120045477238	10201	481,00 €
22	9120045477573	10202	170,00 €
2,22	9120045477580	10203	189,00 €
28	9120045477511	10207	182,00 €
2,28	9120045477528	10208	167,00 €
28	9120045477535	10209	217,00 €
28	9120045477542	10210	115,50 €
28	9120045477559	10211	129,00 €
28	9120045477566	10212	154,50 €
62	9120045476224	11117	186,00 €
23,37	9120045473353	11120	411,00 €
4,19	9120045475586	11137	643,00 €
19,37	9120045476392	11140	789,00 €
62	9120045476651	11142	175,00 €
4	9120045476897	11143	390,00 €
63,19	9120045477177	11146	659,00 €
	9120045477443	11147	396,00 €
38	9120045473711	20002	133,00 €
30	9120045472585	20004	183,00 €
30	9120045470161	20010	8,20 €
30	9120045470253	20020	9,30 €
30	9120045470307	20025	9,30 €
30	9120045470376	20032	9,30 €
30	9120045470451	20040	9,30 €
24	9120045473049	20059	21,60 €
56	9120045472523	20060	7,80 €
56	9120045472530	20061	9,30 €
56	9120045472547	20062	11,30 €
56	9120045472554	20063	12,40 €
56	9120045472561	20064	14,40 €
56	9120045472578	20065	15,50 €
27,29	9120045474053	20108	7,20 €
37,40	9120045474077	20116	8,00 €
37,40	9120045474091	20119	8,20 €
25	9120045473209	20238	29,00 €
23	9120045472820	20240	110,00 €
23	9120045472837	20241	126,00 €
23	9120045472844	20242	144,00 €
38	9120045473384	20250	22,70 €
38,40	9120045473391	20251	24,70 €

Page	EAN-Code	Item no.	Rec. trade price
40	9120045473407	20252	40,20 €
30	9120045472868	20253	17,50 €
25	9120045473032	20260	9,30 €
20,25	9120045473018	20261	7,00 €
25	9120045473001	20262	10,30 €
37,40,45	9120045473728	20266	41,20 €
37,40,45	9120045473735	20267	43,30 €
37,40,45	9120045473742	20268	44,30 €
37,40,45	9120045473759	20269	46,40 €
21,23,33	9120045473292	20272	26,80 €
21,23,33	9120045473308	20273	29,90 €
21,23,33	9120045473315	20274	34,00 €
38,41	9120045474350	20278	43,30 €
38,40	9120045473230	20279	18,50 €
38,40	9120045474800	20280	15,50 €
41	9120045473766	20300	171,00 €
37,40	9120045474084	20303	8,20 €
37	9120045473438	20311	82,00 €
37	9120045473445	20312	97,00 €
37	9120045473452	20313	113,00 €
37	9120045473469	20314	131,00 €
37	9120045473476	20315	162,00 €
40	9120045473261	20316	12,40 €
40	9120045473483	20317	106,00 €
40	9120045473490	20318	129,00 €
40	9120045473506	20319	148,00 €
40	9120045473513	20320	188,00 €
40	9120045473414	20321	14,40 €
38	9120045473254	20322	11,30 €
38	9120045473421	20323	14,40 €
30	9120045473780	20333	8,20 €
27,33	9120045474114	20365	18,50 €
27,33	9120045474121	20366	19,60 €
27,33	9120045474138	20367	29,90 €
44	9120045474145	20368	130,00 €
44	9120045474152	20369	146,00 €
44	9120045474169	20370	166,00 €
44	9120045474176	20371	207,00 €
44	9120045474183	20372	244,00 €
44	9120045474190	20373	144,00 €
44	9120045474206	20374	171,00 €
44	9120045474213	20375	199,00 €
44	9120045474220	20376	247,00 €
44	9120045474237	20377	309,00 €
44	9120045474244	20378	350,00 €

Page	EAN-Code	Item no.	Rec. trade price
45	9120045474268	20379	10,30 €
45	9120045474275	20380	14,40 €
45	9120045474282	20381	10,30 €
44,47,49	9120045474299	20382	40,20 €
44,47,49	9120045474305	20383	27,80 €
44	9120045474312	20384	47,40 €
44	9120045474329	20385	53,00 €
46	9120045474541	20386	523,00 €
44,47,49	9120045474336	20387	36,10 €
34	9120045474343	20388	22,70 €
3,12	9120045477719	20401	148,00 €
38	9120045474374	20402	183,00 €
41	9120045474367	20403	231,00 €
44,47,49	9120045474398	20404	25,80 €
45	9120045474404	20405	330,00 €
44,47,49	9120045474411	20409	23,70 €
27	9120045474107	20411	7,20 €
45	9120045474251	20412	14,40 €
44	9120045474442	20414	281,00 €
47	9120045474473	20416	411,00 €
46	9120045474558	20417	535,00 €
46	9120045474565	20418	665,00 €
46	9120045474572	20419	832,00 €
46	9120045474589	20420	983,00 €
46	9120045474596	20421	1 144,00 €
47	9120045474602	20422	12,40 €
47	9120045474985	20423	17,50 €
47	9120045474626	20424	61,00 €
25,38,41	9120045474633	20427	7,10 €
25,38,41	9120045474640	20428	7,10 €
34	9120045474657	20436	64,00 €
34	9120045474664	20437	68,00 €
34	9120045474671	20438	72,00 €
34	9120045474688	20439	81,00 €
34	9120045474695	20440	96,00 €
34	9120045474701	20441	113,00 €
42,45,49	9120045474718	20442	102,00 €
45,47	9120045474725	20443	6,00 €
25	9120045474831	20455	17,50 €
25	9120045474848	20457	12,40 €
20,37,40	9120045474855	20460	29,00 €
44	9120045474879	20461	109,00 €
47	9120045474886	20462	115,00 €
20,24	9120045475081	20468	20,60 €
20,27	9120045475098	20475	23,70 €

Page	EAN-Code	Item no.	Rec. trade price
27	9120045475104	20476	47,40 €
20	9120045475180	20481	69,00 €
20	9120045475197	20483	6,80 €
20	9120045474930	20484	9,60 €
20,24	9120045474947	20485	47,40 €
21,27,38	9120045474954	20487	9,40 €
20	9120045474961	20488	141,00 €
49	9120045474978	20489	177,00 €
49	9120045474992	20490	57,00 €
48	9120045475005	20491	1 029,00 €
48	9120045475012	20492	1 272,00 €
48	9120045475029	20493	1 545,00 €
48	9120045475036	20494	1 815,00 €
48	9120045475043	20495	2 081,00 €
48	9120045475050	20496	2 394,00 €
49	9120045475067	20497	1 639,00 €
49	9120045475203	20498	58,00 €
20	9120045475241	20509	8,00 €
17	9120045475265	20522	7,10 €
17	9120045475272	20523	8,20 €
52	9120045475296	20525	340,00 €
52	9120045475302	20526	335,00 €
52	9120045475319	20527	259,00 €
20	9120045476156	20559	345,00 €
20	9120045476149	20560	300,00 €
44	9120045476194	20562	416,00 €
20	9120045476132	20593	214,00 €
20	9120045476088	20606	22,10 €
20	9120045476064	20607	17,00 €
20	9120045476019	20608	29,90 €
13	9120045475678	20609	29,90 €
13	9120045476095	20610	31,90 €
30,54	9120045476118	20611	56,00 €
20,54	9120045476026	20612	56,00 €
23,54	9120045476002	20613	56,00 €
25	9120045476101	20614	24,70 €
52	9120045475838	20615	272,00 €
52	9120045475845	20616	356,00 €
52	9120045475852	20617	510,00 €
52	9120045475869	20618	595,00 €
52	9120045475876	20619	178,00 €
52	9120045475883	20620	262,00 €
52	9120045475890	20621	131,00 €
50	9120045475722	20622	143,00 €
13	9120045475661	20623	75,00 €

Page	EAN-Code	Item no.	Rec. trade price
32	9120045475739	20624	14,40 €
32	9120045475746	20625	14,90 €
32	9120045475753	20626	15,50 €
32	9120045475760	20627	16,00 €
32	9120045475784	20628	14,40 €
32	9120045475791	20629	14,90 €
32	9120045475807	20630	15,50 €
32	9120045475814	20631	16,00 €
9,10	9120045476071	20632	10,30 €
44,47	9120045476187	20646	31,90 €
50	9120045476613	20657	196,00 €
50	9120045476620	20658	162,00 €
34,52	9120045476248	20661	41,20 €
34,52	9120045476255	20662	43,30 €
34,52	9120045476262	20663	44,30 €
34,52	9120045476279	20664	48,40 €
34,52	9120045476286	20665	55,00 €
34,52	9120045476293	20666	60,00 €
34,52	9120045476309	20667	70,00 €
34,52	9120045476316	20668	82,00 €
34,52	9120045476323	20669	96,00 €
34,52	9120045476330	20670	109,00 €
50	9120045476415	20683	114,00 €
14	9120045476484	20692	519,00 €
14	9120045476491	20693	562,00 €
14	9120045476507	20694	606,00 €
9	9120045476538	20696	55,00 €
7	9120045475326	20706	34,00 €
7	9120045475333	20707	13,40 €
7,54	9120045475340	20708	56,00 €
14	9120045476644	20711	139,00 €
7	9120045476637	20714	39,10 €
7	9120045476705	20738	17,50 €
7	9120045476712	20739	40,20 €
27	9120045477184	20816	46,50 €
27	9120045477191	20817	54,60 €
27	9120045477207	20818	66,00 €
27	9120045477276	20819	36,80 €
27	9120045477269	20824	6,00 €
27	9120045477252	20825	4,20 €
27	9120045477283	20826	30,50 €
27	9120045477290	20829	4,10 €
7	9120045477337	20849	20,50 €
7	9120045477344	20850	22,70 €
7	9120045477351	20851	22,70 €

Page	EAN-Code	Item no.	Rec. trade price
10,11	9120045477405	20881	16,00 €
29	9120045477627	20947	7,90 €
29	9120045477634	20948	8,00 €
29	9120045477641	20949	8,50 €
29	9120045477658	20950	10,90 €
29	9120045477665	20951	19,90 €
29	9120045477610	20952	35,00 €
29	9120045477672	20953	43,00 €
29	9120045477689	20954	55,00 €
29	9120045477733	20955	9,50 €
29	9120045477740	20956	22,00 €
3,12	9120045477726	20957	148,00 €
25	9120045473193	30009	22,70 €
56	9120045471977	30010	14,40 €
56	9120045471984	30011	21,60 €
56	9120045471991	30012	26,80 €
56	9120045472004	30013	33,00 €
56	9120045472011	30014	40,20 €
31	9120045472028	30017	26,80 €
31	9120045472035	30018	35,00 €
31	9120045472042	30019	43,30 €
31	9120045472059	30020	52,00 €
31	9120045472066	30021	56,00 €
21	9120045472073	30027	17,10 €
21	9120045472080	30028	18,40 €
21	9120045472097	30029	22,10 €
21	9120045472103	30030	25,80 €
33	9120045472158	30039	21,60 €
33	9120045472165	30040	23,70 €
33	9120045472172	30041	36,10 €
21	9120045472189	30042	30,50 €
21	9120045472196	30043	35,30 €
29,38,41	9120045472240	30050	8,40 €
31	9120045474466	30054	19,60 €
17	9120045472301	30063	7,40 €
17	9120045472318	30064	8,90 €
38,41,45	9120045472356	30067	20,60 €
29,38,41	9120045472387	30070	6,40 €
23	9120045473841	30146	36,10 €
38,40	9120045473025	30208	4,90 €
25	9120045473124	30210	4,30 €
25	9120045473056	30236	5,50 €
24	9120045472998	30239	20,80 €
17	9120045474862	30467	4,40 €

All prices are ex-works 5303 - Thalgau - AUSTRIA - plus statutory taxes and duties. All price information represents non-binding price recommendations. Pricelist 2024. All illustrations are symbol photos. Typing and printing errors reserved.

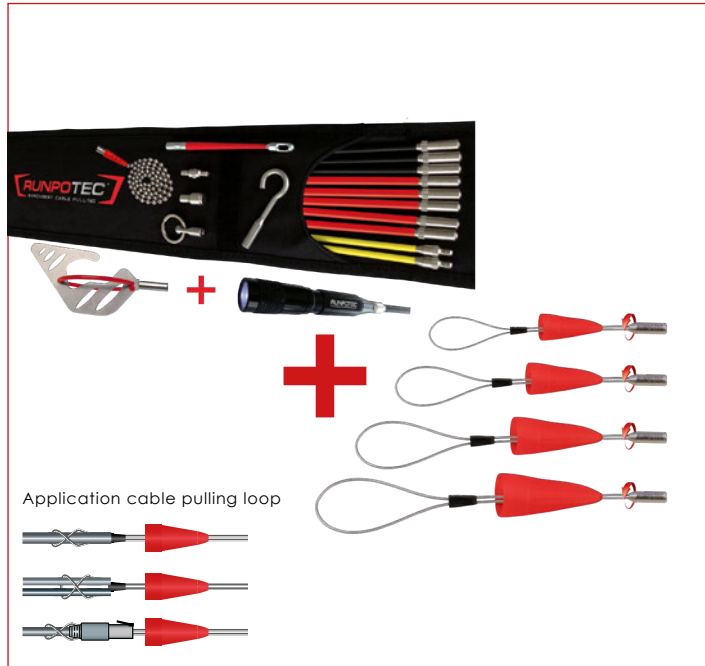

PROMOTION DESCRIPTION

RUNPOSTICKS - Comfort package + Cable pulling loop with thread - Set of 4

- 1 x RUNPOSTICKS - Comfort package 19-parts
Field of application: suspended ceilings, cable ducts, hollow walls usw...
- 1 x Cable pulling loop with thread RTG Ø 6 mm - set of 4
Field of application: to protect pre-assembled cables incl. plugs or to protect several cables at the same time.

For more information see product videos.

€ **186,-**
plus tax

RUNPOSTICKS - Cable pulling loop - offer
RUNPOTEC Item no. 11117

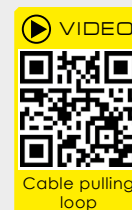

PROMOTION DESCRIPTION

RP5 without meter counter - 30 m + Cable pulling loop with hook - Set of 4

- 1 x RP5 without meter counter - 30 m
incl. 2 x RG7 - Guiding head with swivel
- 1 x Cable pulling loop with hook - set of 4
Field of application: To pull pre-fabricated cables incl. plugs in a protected manner. For pipes with an inner diameter of 14 mm or more and non-guided lines.

For more information see product videos.

INSTEAD OF € 204,20
€ **175,-**
plus tax

RP5 - Cable pulling loop - offer
RUNPOTEC Item no. 11142



RUNPOLIFTER 4500 Cable drum lifter

The RUNPOLIFTER 4500 is a foldable cable drum lifter that is capable of lifting drums with a maximum diameter of 1600 mm and a maximum weight of 4500 kg and a max. width of 1250 mm. For more information see product videos

Scope of supply:

- 1 x Lifting support right, 1 x Lifting support left
- 1 x Drum shaft, 2 x centring cones



Lifter Sets	Shaft length	Item no.	Rec. trade price
Lifter 1150	1150 mm	10162	2688,00 €
Lifter 1350	1350 mm	10163	2730,00 €
Lifter 1600	1600 mm	10164	2771,00 €



PROMOTION -DESCRIPTION

GF3 Glass Fiber Ø 3 mm - 30 m + RC2 Inspection camera - 30 m

- 1 x GF3 - 30 m, with integrated digital meter counter - m/ft., cable pulling system, optimal for pipe diameter Ø 10 - 50 mm
- Total breaking load 130 kg (fiberglass rod incl. kink protection)
- 1 x RC2 Inspection camera with 30 m cable
- Field of application in combination with GF3: pipe inspections over long distances up to 50 m - as of 14 mm inner diameter

For more information see product videos

INSTEAD OF € 725,00

€ **659,-**
plus tax

GF3 - 30 m - RC2 - 30 m - offer
RUNPOTEC Item no. 11146



PROMOTION-DESCRIPTION

GF4.5 Fiberglass rod Ø 4,5 mm - 50 m + RC2 Inspection camera - 50 m

- 1 x GF4.5 Fiberglass rod Ø 4,5 mm - Profi-Set - 50 m
- Field of application: optimal for pipe-Ø 30 - 80 mm
- 1 x RC2 Inspection camera with 50 m cable
- Field of application: See description above
- Including accessories, see page 18

For more information see product videos

INSTEAD OF € 923,00

€ **789,-**
plus tax

GF4.5 - 50 m - RC2 - 50 m - offer
RUNPOTEC Item no. 11140



Quality check



RUNPOTEC products are checked at several stages for

- Breaking load
- Material quality
- Material fatigue
- Mechanical stress
- Functional ability



A large part of the RUNPOTEC products are made of stainless steel

- High stainless steel quality
- Precise processing
- High load capacity

EXTRA STRONG, up to max. 800 kg, has the pulling power of approx. 10 people

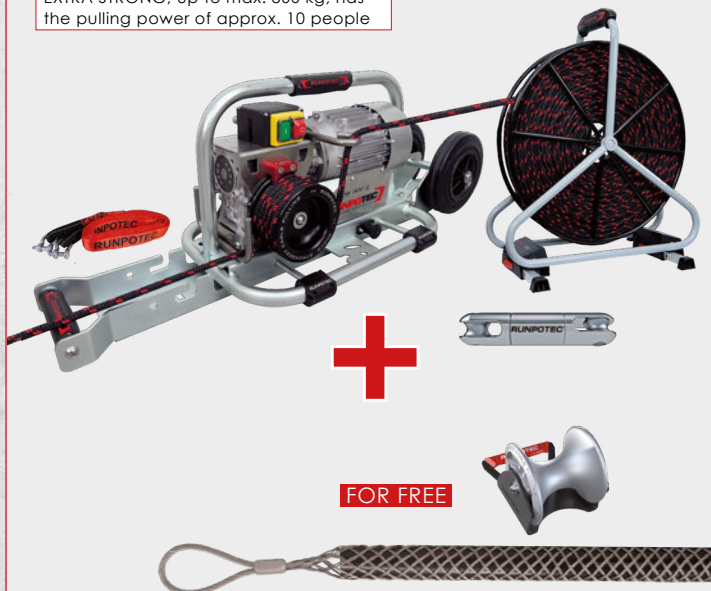

FOR FREE

PROMOTION OFFER!

Buy **1x capstan winch + 1x pulling rope + 1x connection swirl**, get **1x cable pulling grip + 1x cable guide roller – shaft** for free!

- CW 800 E Capstan winch incl. trolley mounting rail and strap for horizontal cable pulling (230 V / 50 Hz - 0,75 kWh / 5,1 A)
- Polyester cable pulling rope incl. steel reel
- Connection swirl with swivel Ø 30 mm
- Cable pulling grip with loop, made of high quality, galvanised steel double weave

See page 48 – 50 for details

Further information is available at www.runpotec.com or in the product video



VIDEO Cable guide roller Shaft

Cable guide roller Shaft inside edge



Cable guide roller 90 degrees - 3 R

Cable guide roller 90 degrees



Cable guide roller - chain - 3 to 6 roll links



Cable guide roller

High performance guide roller with integrated ball bearings. Heavy duty rollers made from aluminium, CDP/ powder coated frame, Roller-Ø 130 mm, max. cable-Ø 100 mm
Load capacity 4.500 kg - Item No. 10166, 10157, 10156 and 10153
Load capacity 2.500 kg - Item No. 10189



Cable guide roller	Item no.	Rec. trade price
Shaft (for insert cables into or out of shafts)	10157	82,00 €
Shaft inside edge (for shafts or stages)	10156	82,00 €
90 degrees (for shafts or stages)	10153	157,00 €
90 degrees 3R (for corners and edges)	10189	247,00 €
Chain 3-parts (universally applicable)	10166	241,00 €
Chain 4-parts (universally applicable)	10199	321,00 €
Chain 5-parts (universally applicable)	10200	402,00 €
Chain 6-parts (universally applicable)	10201	481,00 €



Cesta na Brdo 85, 1000 Ljubljana
tel: +386 1 256 10 56, fax: +386 1 256 10 55
mailto: info@energie.si, <http://www.energie.si>



Newsletter Sign up



Scan the QR code, subscribe and be informed immediately about new products and promotions.

