

# REMS

[www.rems.de](http://www.rems.de)



Innovative  
manufacturer of  
machines and tools  
for pipe working

**2024**

Catalogue



Product information

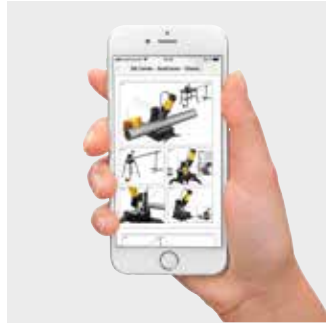

Operating instructions

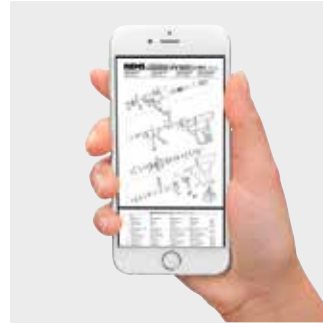

Parts lists

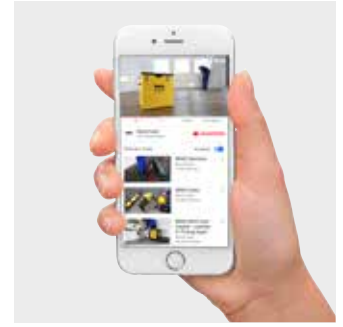

Product films

## REMS App – All product information available any time, anywhere – quickly and easily.

On the building site or at your dealer: All operating instructions, parts lists, product information, product films and more can be called upon immediately\*. Many other functions are also available to you.



### Scan product logo

Are you standing in front of a REMS product? Just scan the product logo and you will get all the product details.



### Scan product illustration

You can scan the product illustrations in our offer brochures and get all the details about the product.



### Scan QR code

You can scan the REMS QR code and get all the details about the product.



### REMS App

Free application software from the Apple App Store or Android App at Google Play.



\*Only with an existing data link via network operator or wifi.

# Contents















We deliver exclusively on the basis of our general conditions of sale and delivery.

The prices stated in this catalogue are valid for one piece respectively for one set (e.g. dies) or one pack (e.g. saw blades). Prices do not include any value added tax (VAT) and are subject to change without notice. We reserve the right to increase prices. These prices supersede all previous prices.

Drawings, illustrations, dimensions, weights, standards and other data stated in this catalogue are not binding and are subject to alteration. All power data stated to be understood as the rated power input. Subject to alternation. All rights reserved, particularly for translations, reproductions, illustrations, radio transmission, photomechanic reproductions or similar and storage of data in computers, including utilization in extracts.

© Copyright 2024  
REMS GmbH & Co KG, Waiblingen.

**Sale through specialist dealers.**

	<b>Threading Roll Grooving</b>	<b>20</b>
	<b>Sawing</b>	<b>54</b>
	<b>Cutting, chamfering, deburring, calibrating</b>	<b>72</b>
	<b>Assembling</b>	<b>102</b>
	<b>Testing, cleaning, disinfecting, preserving, flushing, filling</b>	<b>112</b>
	<b>Bending</b>	<b>126</b>
	<b>Radial Press Jointing</b>	<b>144</b>
	<b>Axial Press Jointing</b>	<b>242</b>
	<b>Expanding, Extracting</b>	<b>250</b>
	<b>Soldering</b>	<b>262</b>
	<b>Freezing</b>	<b>268</b>
	<b>Pipe and Drain Inspection / Pipe and Drain Cleaning</b>	<b>272</b>
	<b>Plastic Pipe Welding</b>	<b>290</b>
	<b>Diamond Core Drilling Diamond chasing saws</b>	<b>300</b>
	<b>Drying, dehumidifying, aeration and deaeration</b>	<b>326</b>



They are creative and have plenty of practical experience, they continuously find possibilities for improvement of the work of the installation professional: REMS development engineers are innovative and therefore important factors in the success of the company.

# REMS – heading technical progress for more than 110 years. Development is never finished.

Since its foundation in 1909 REMS has been developing products for the pipe working, especially for sanitary and heating installers. At first, hand tools and then subsequently machines and electric power tools. The stipulation of the company founder Christian Föll "REMS must be superior" has always been the benchmark for our actions. Today REMS is a leading manufacturer of machines and tools for the pipe working.

REMS development engineers have persuasive, groundbreaking ideas which ease the daily routines of the installations professional. They have all the significant requirements in their focus and use all their comprehensive practical experience. Experts from all areas of industry ensure that every possibility for improvement is integrated in the new development. In this way the perfect tools for the tough demands of the building site are created. The REMS products are highly valued because of their innovative technology as well as their high standards of quality and are being used everywhere in the world. Both trade and user profit in this way.

Again and again REMS is able to maintain its position at the forefront of technical progress as a result of its innovative products. Many valid national and international patents prove this.

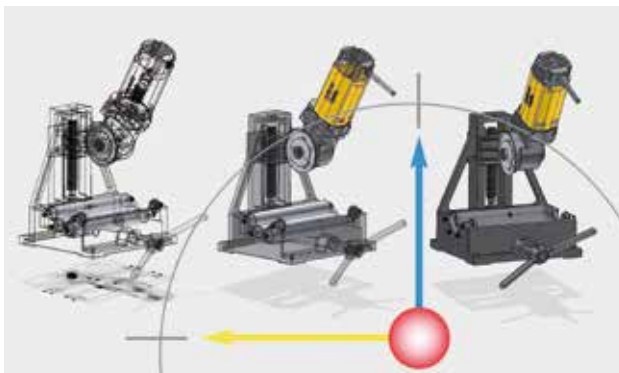

Through the application of modern construction and development techniques, the quality of REMS products has been to the fore from the beginning: Safe use, robust design, simple operation, durability.



New ideas, technical progress and REMS belong together: e.g. REMS Amigo, REMS Tiger, REMS Curvo, REMS Akku-Press 22V Connected, REMS Multi-Push – products, which have revolutionised the application technology.



Fully automatic 3D measuring machines are a part of the comprehensive quality control system at REMS. The accuracy of measurements at 0.001 mm guarantees the highest precision.

# Highly modern production – guarantor for REMS quality products.

Made in Germany. Our own production plant is located in Waiblingen near Stuttgart, in the centre of Germany's high-tech industrial region. There highly modern equipment and facilities are available for research and development, for production and quality control. In addition to this there is a permanent staff of highly-qualified employees, who in part represent the 4th generation of service at REMS. They have the special level of knowledge and experience that is essential for the manufacture of quality products.

Quality means much more to REMS than simply dimensional accuracy and function. It is backed up by a comprehensive quality control system, which begins as early as the assessment of market needs and which is ever present during the product development and manufacture and continues with systematic quality analysis in the market. Furthermore the quality of the production processes is regularly monitored and affirmed by the testing agency that awards the GS safety sign.

All REMS products correspond with safety and accident prevention regulations and fulfil the respective appropriate European standards according to the terms of the EU directives. Additionally, with the exception of a few hand tools which are not safety relevant, all REMS products are checked and approved by independent testing agencies. All REMS products thereby meet an especially high standard with regard to work safety, functional safety and operational safety.



Permanent innovations in processes as well as investments in efficient CNC manufacturing systems engineering ensure that REMS products are amongst the best in the world.



Flexible assembly lines allow adjustment to the requirements of the customer at any time.

REMS is evaluated as having the largest number of training staff in the region. So it is able to maintain its own know-how at a high level.



Tightly defined test intervals during the whole manufacturing process as well as comprehensive function and safety checks after completion of the assembly ensure that no faulty product leaves the plant.



Reliable staff with many years experience are responsible for ensuring that the optimum progression of the hardening process in the material for each component is realised exactly.



# Nobody hardens metal better than us. Therefore, we do it ourselves.

Highly durable, safe in application and extremely resilient – a tool can only meet such demands if the components are perfectly hardened.

An important cornerstone for the quality of REMS tools is laid in our own heat treatment shop. The decades of experience has provided important know-how and is the secret of REMS quality tools. The special heat treatment leads to an ideal combination of solidity and robustness and to an especially long durability, as, for example for threading dies, cutter wheels and pressing tongs. The heat treatment process is automatically monitored and permanently recorded by efficient computer technology. This allows a uniformly high product quality.



Our own heat treatment shop – an important aspect of the know-how and the secret of REMS quality tools.



The proven, indestructible REMS quality threading dies. Of robust, especially hardened special steel.



REMS cutter wheels complement the special demands of the various materials. In particular the special hardening process determines the durability of the REMS cutter wheels.



The art of hardening:  
It creates extremely resilient components for the highest demands.



**REMS**  
for Professionals

**REMS**  
for Professionals

**REMS**  
for Professionals

5

10

11

12

**REMS**

Only two from every 45 employees in the logistics industry know that time is money. Speed and absolute reliability are the most important factors for delivery and service.

# REMS – for professionals.

## Excellent service. On location everywhere.

REMS produces machines and tools for professionals – the demands required are high. REMS fulfils its tasks with competence, responsibility and a first-rate service. This also includes the swift delivery as well as maintenance and repair work. A high degree of flexibility and absolute reliability are the basis for the excellent service.

The whole logistics organisation is oriented towards the needs of our customers. In order to be able deliver promptly REMS keeps more than 10,000 items ready in the central storage facility. All wear and replacement parts are always available. A service that keeps down-times to a minimum.

In the case of a repair the area-wide network of contracted customer service workshops is available for a rapid and professional repair. Highly-qualified and well-trained staff repair and maintain the machines and tools for our customers. After completion of the repair or inspection the products are returned again to the customer by the fastest means.



Speed is a question of logistics. REMS keeps wear and replacement parts in stock in a 14,000 m<sup>2</sup> storage facility.



The demands at the building site are extreme – wear parts are worn, the need for repairs arises. The REMS customer services department is ready and flexible. There is an extensive service organisation in more than 25 countries.



Service is extremely important for REMS: All demonstration vehicles for the more than 200 REMS specialist advisors are fitted with testing equipment with which the function test and force of pressure measurement for REMS radial presses can be carried out on location everywhere.



Product training in the  
REMS training centre:  
Become familiar with,  
compare, evaluate.

## **REMS – business partner to the trade. Excellent advice for contented customers.**

Only those who receive competent advice when purchasing find the individually best, economic solution for the tasks ahead. For this reason REMS assigns great significance to the product training of its own REMS specialist advisors and also the staff in the specialist stores.

In the REMS training centre, modern and fully-fitted demonstration, training and conference rooms are available in an area of 1,600 m<sup>2</sup>. The practical-oriented training gives the staff of the specialist stores, in an understandable form, a broad basis and high specialist competence for product advice and successful sale. The detailed sales documentation with information relating to all necessary product specifications facilitate a swift product selection and are the basis for the simple and time-saving generation of offers.

This partnership with the specialist store also guarantees the user qualified, comprehensive product advice and excellent service.



REMS training centre in Waiblingen near Stuttgart.



Modern and fully-fitted demonstration rooms:  
REMS creates many opportunities for the specialist-store staff to become familiar with the products.



Dennis Maaß, Christian Heipter, Ralf Bähler and Florian Zorn, four of more than 200 qualified REMS specialist advisors are flexible and, when needed, swiftly on location for training courses and presentations.

# REMS – Market strength through a consistent product and sales philosophy.

REMS' basis for market strength is technically-advanced and high-quality products as well as a product range tightly concentrated on high turnover units and highly competitive prices thanks to the rational, economical in-house production.

At the centre of the sales philosophy the principle has always been that REMS products are sold exclusively via specialist dealers. These are supported by REMS in many ways. REMS specialist advisors equipped with demonstration vehicles carry out product training on location and demonstrate the REMS products at on-site visits, counter demonstrations and at in-house exhibitions. They advise in the selection of the tools and find the most comfortable, reliable and economical solution in each individual situation.



The consistent sales philosophy is designed for long-term results, trust and predictability.



This is how installation professionals become familiar with the product range in practice: The REMS specialist advisors are on the road with demonstration vehicles and demonstrate the machines and tools in real situations, directly on the building site.

The REMS product presentation system – the ideal opportunity for the specialist stores to optimally present the REMS products: touch – compare – select.

REMS

REMS

REMS

REMS

REMS

REMS

REMS

REMS



REMS

REMS





# Touch. Compare. Select.

## Promoting the mutual sale.

The participation at many national and international trade fairs, the advertising in trade magazines and the direct mail marketing to the user is highly valued by trade outlets as sales-promotion measures.

The attractive REMS product presentation system provides the trade outlet with an optimal presentation of the REMS products: Touch, compare, select. The individual stocking with REMS products is carried out with close cooperation between the REMS specialist advisors and the trade outlet.

The online information system at [www.rems.de](http://www.rems.de) offers extensive opportunities to find out information about the REMS group, the REMS products and their application possibilities and operation. Furthermore, the user has access to the complete online catalogue and detailed technical documentation, information about current trade fair appearances and addresses of REMS contracted customer service workshops, download opportunities of sales documentation, operating instructions, parts lists, product illustrations and product films, opportunities to order sales documentation in various languages for postal dispatch, e-mail addresses for REMS contacts and much more.



The REMS products are exhibited and demonstrated at many national and international trade fairs.



Practical for the trade, clear for the customers – the REMS product presentation system.



The online information system at [www.rems.de](http://www.rems.de)



REMS App



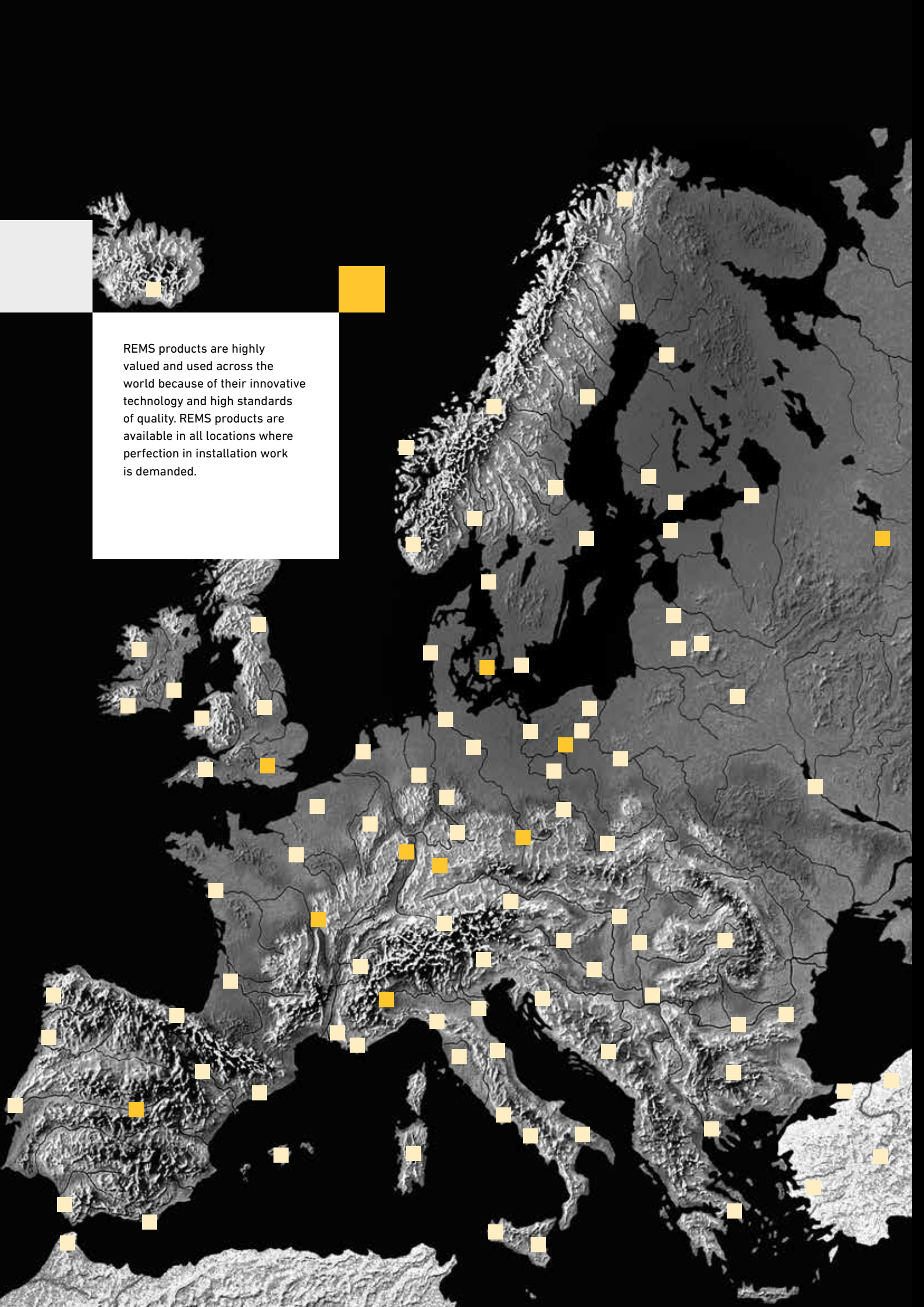

REMS products are highly valued and used across the world because of their innovative technology and high standards of quality. REMS products are available in all locations where perfection in installation work is demanded.

# More than 20,000 trade partners in Europe: REMS products are available locally everywhere.

Innovative products and a high standard of quality open new markets for REMS. In the last years the market area has been continuously build-up and extended. Reliable trade partners throughout Europe and beyond guarantee that ever more customers can be persuaded of the quality of REMS.





REMS sets benchmarks for quality throughout Europe – the sales are carried out through the tight network of reliable trade partners in the whole of Europe which are in turn supported by more than 200 well trained REMS specialist advisors.



Sales subsidiaries in many countries deliver optimum conditions for users and trade outlets.



# Threading Roll Grooving

	<b>Hand die stocks</b>	<b>22</b>
	<b>Quick-change die heads S</b>	<b>23</b>
	<b>Electric die stocks</b>	<b>24</b>
	<b>Cordless die stock</b>	<b>28</b>
	<b>Threading machines</b>	<b>32</b>
	<b>Semi-automatic threading machines</b>	<b>42</b>
	<b>Pipe nipple chucks</b>	<b>46</b>
	<b>Thread-cutting oil</b>	<b>47</b>
	<b>Roll grooving attachments</b>	<b>48</b>
	<b>Roll grooving machine</b>	<b>49</b>
	<b>Cordless roll grooving machine</b>	<b>50</b>
	<b>Roll grooving machines</b>	<b>52</b>

Proven quality die stock with excellent threading capabilities.

Pipe threads	1/8" – 2", 16 – 50 mm
Bolt threads	6 – 30 mm, 1/4" – 1"

Thread types see page 30, 31.

**REMS eva – the plumber's die stock.**  
**Excellent start-cutting and threading.**  
**Steel ratchet lever, thickly plastic coated.**  
**Only one type of quick-change die heads.**  
**Indestructible quality dies.**

### System advantage

Large working range up to 1 1/4" and up to 2" with only **one** ratchet lever. Only **one** type of small, compact quick-change die heads and only **one** type of dies. The same quick-change die heads fit all REMS die stocks and other suitable makes of die stocks. Efficient and easy stocking. No confusion possible.

### Ratchet lever

Robust. Ratchet lever in steel, thickly plastic coated, for convenient operation. Serrated plastic handle for secure grip. Easy adjustment of ratchet rotation. Perfect, secure seating of quick-change die heads, fast and easy change.

### Quick-change die heads

Proven technology, high-grade material and precise machining of die head, dies and cover form a unit and ensure an excellent start-cutting performance and easy threading. No stalling of dies. Long, precise pipe guidance for perfect pipe centering. The chip holes which become wider at the outside enable good chip flow and clean threads. Quick-change die heads S for cutting pipe threads in hard-to-reach areas (page 23).

### Dies

The proven, indestructible REMS quality dies with precise cutting geometry ensure an excellent start-cutting performance, easy threading and clean threads. Dies in a high-quality special-grade steel, fully tempered and hardened, for extremely long die life.

### Thread-cutting oil

REMS Sanitol and REMS Spezial (page 47). Specially developed for threading. High cooling and lubricating effect. Essential for clean threads and longer service life of dies, tools and machines.

### Nipple-threading

Efficient with REMS Nippelspanner 3/8" – 2" (page 46).



German Quality Product



Info

### Supply format

**REMS eva Set.** Hand die stock with quick-change die heads. For pipe threads 1/8" – 2", 16 – 50 mm, bolt threads 6 – 30 mm, 1/4" – 1". For right and left-hand threads. 1 ratchet lever for the complete work range. Quick-change die heads with dies for pipe threads, tapered, ISO 7-1, EN 10226 (DIN 2999, BSPT) R right-hand respectively for threading electric conduit according to EN 60423 M. In sturdy steel case or in a cardboard box.

Description/Size	Art.-No.	€
<b>REMS eva Set in steel case</b>		
R 1/2 + 3/4 + 1	520014	415,20
R 1/2 + 3/4 + 1 + 1 1/4	520015	493,05
R 3/8 + 1/2 + 3/4 + 1 + 1 1/4	520013	560,52
R 1/2 + 3/4 + 1 + 1 1/4 + 1 1/2 + 2	520017	685,08
R 3/8 + 1/2 + 3/4 + 1 + 1 1/4 + 1 1/2 + 2	520016	757,74
M 16 + 20 + 25 + 32 (M x 1,5)	520010	581,28
M 20 + 25 + 32 + 40 (M x 1,5)	520009	622,80
<b>REMS eva Set in cardboard box</b>		
R 1/2 + 3/4	520008	259,50
R 1/2 + 3/4 + 1	520004	332,16
R 3/8 + 1/2 + 3/4 + 1 + 1 1/4	520003	477,48

REMS eva sets available for left-handed threads and NPT threads.

### Accessories

Description	Art.-No.	€
<b>Ratchet lever</b> for complete work range	522000	168,16
<b>Quick-change die heads S</b> see page 23.		
<b>Quick-change die heads, dies, attachment heads for button dies</b> , see page 30 – 31.		
<b>Steel case</b> with inlay, for REMS eva 3/8" – 2"	526050	110,03
<b>Thread-cutting oil</b> see page 47.		
<b>REMS Nippelspanner</b> 3/8" – 2" see page 46.		
<b>REMS Aquila 3B</b> , pipe workstation with chain pipe vice on folding tripod stand, see page 105.		
<b>REMS Aquila WB</b> , chain pipe vice for workbench, see page 105.		



# REMS quick-change die heads S

Accessories for REMS eva and other makes

For cutting pipe threads in hard-to-reach areas, e.g. caved wall, lay bare pipes, trench. Ideal for repair and renovation.

Pipe threads 3/8 – 1 1/4"

## REMS quick-change die heads S – the trouble shooter for hard-to-reach areas.

Quick-change die heads S with specially mounted dies.

Additional, precise pipe guidance at the cover side ensure perfect pipe centering and easy start-cutting.

Extension of ratchet drive REMS eva for threading in caved areas.

Quick-change die heads S and extension fit into the ratchet lever REMS eva and other suitable die stocks.



German Quality Product



Info

### Supply format

**Die heads S Set.** choice of quick-change die heads S for pipe threads tapered, right-hand ISO 7-1, EN 10226 (DIN 2999, BSPT) respectively Taper Pipe Thread ASME B1.20.1, Extension 300 mm. In sturdy steel case.

Description	Art.-No.	€
Set R 3/8 + 1/2 + 3/4	520025R	560,52
Set R 1/2 + 3/4 + 1	520026R	570,90
Set NPT 1/2 + 3/4 + 1	520056R	570,90



### Accessories

Description	Size	Art.-No.	€
<b>Ratchet lever</b> for complete work range		522000	168,16
<b>Quick-change die heads S</b>			
Pipe threads tapered, right ISO 7-1, EN 10226 (DIN 2999, BSPT)	R 3/8	521026	155,70
	R 1/2	521036	161,93
	R 3/4	521046	169,19
	R 1	521056	175,42
	R 1 1/4	521066	182,69
<b>Extension</b> 300 mm		522051	168,16
<b>Steel case</b> with inlay for ratchet lever, 4 quick-change die heads S and extension.		526052R	110,03



Powerful, super handy electric tools for threading with unique support bracket. Ready to use anywhere, without vice. Ideal for repair, renovation, job site.

Pipe threads	1/8 – 1", 16 – 32 mm
Bolt threads	6 – 30 mm, 1/4 – 1"

Thread types see page 30, 31.

## REMS Amigo E – the fastest, strongest and lightest up to 1".

### System advantage

Only **one** type of small, compact quick-change die heads and only **one** type of dies for all REMS die stocks. Thus efficient and easy stocking. No confusion possible.

### Support bracket

Solid, easy to use, supports the die stock against torque in both directions. Secure clamping through angular clamping spindle with self-supporting effect. Very simple mounting of die stock onto support bracket and pipe.

### Design

Compact, robust, job site-proven. Can be used anywhere, even without vice. Slender design for working in confined areas. Drive unit only 3.4 kg, without die head. No heavy top, therefore single-hand operation possible. Perfect, secure seating of quick-change die heads.

### Drive

Solid, compact, maintenance-free gear. Robust, powerful 950 W universal motor with 30 % power increase thanks to automatic carbon brush adjustment while changing the direction of rotation. Peak power input up to 1500 W. Fast threading time 35 – 27 rpm. Safety tip switch.

### Quick-change die heads

Proven technology, high-grade material and precise machining of die head, dies and cover form a unit and ensure an excellent start-cutting performance and easy threading. No stalling of dies. Long, precise pipe guidance for perfect pipe centering. The chip holes which become wider at the outside enable good chip flow and clean threads.

### Dies

The proven, indestructible REMS quality dies with precise cutting geometry ensure an excellent start-cutting performance, easy threading and clean threads. Dies in a high-quality special-grade steel, fully tempered and hardened, for extremely long die life.

### Thread-cutting oil

REMS Sanitol and REMS Spezial (page 47). Specially developed for threading. High cooling and lubricating effect. Essential for clean threads and longer service life of dies, tools and machines.

### Nipple-threading

Efficient with REMS Nippelspanner 3/8 – 1" (2") (page 46).



German Quality Product



Info

## Supply format

**REMS Amigo E Set.** Electric die stock with quick-change die heads. For pipe threads 1/8 – 1", 16 – 32 mm, bolt threads 6 – 30 mm, 1/4 – 1". For right and left-hand threads. Drive unit with maintenance-free gear, powerful universal motor 230 V or 110 V, 50 – 60 Hz, 950 W, safety tip switch, power increase thanks to automatic carbon brush adjustment. Peak power input up to 1500 W. Right and left-hand rotation. Support bracket for both directions. REMS eva quick-change die heads for pipe threads, tapered, ISO 7-1, EN 10226 (DIN 2999, BSPT) R right-hand respectively for threading electric conduit according to EN 60423 M. In sturdy steel case.

Description	Art.-No.	€
<b>Set R 1/2 + 3/4 + 1</b>	530013R220	<b>913,44</b>
<b>Set M 20 + 25 + 32</b>	530014R220	<b>975,72</b>

REMS Amigo E Set for NPT threads available.

## Accessories

Description	Art.-No.	€
<b>Quick-change die heads, dies, attachment heads for button dies, see page 30 – 31.</b>		
<b>REMS Amigo E drive unit</b>	530003R220	<b>517,96</b>
<b>Support bracket</b>	533000R	<b>165,04</b>
<b>REMS REG St 1/2 – 2"</b> , pipe deburrer, see page 97.	731700	<b>150,51</b>
<b>Dual purpose holder</b> for threading and sawing with REMS Amigo E, Amigo, Amigo 2 and REMS Tiger	543100	<b>264,69</b>
<b>Ratchet lever</b> see page 22.	522000	<b>168,16</b>
<b>Thread-cutting oil</b> see page 47.		
<b>REMS Nippelspanner 3/8 – 2"</b> see page 46.		
<b>Steel case with inlay</b>	536000	<b>110,03</b>





Powerful, easy-to-operate electric tool for threading with unique support bracket. Ready for use anywhere, without vice. Ideal for repair, renovation, job site.

Pipe threads  $\frac{1}{8}$  –  $1\frac{1}{4}$ " , 16 – 40 mm  
Bolt threads 6 – 30 mm,  $\frac{1}{4}$  – 1"

Thread types see page 30, 31.

## REMS Amigo – the smallest, lightest, strongest and fastest up to $1\frac{1}{4}$ ".

### System advantage

Only **one** type of small, compact quick-change die heads and only **one** type of dies for all REMS die stocks. Thus efficient and easy stocking. No confusion possible.

### Support bracket

Solid, easy to use, supports the die stock against torque in both directions. Secure clamping through angular clamping spindle with self-supporting effect. Very simple mounting of die stock onto support bracket and pipe.

### Design

Compact, robust, job site-proven. Can be used anywhere, even without vice. Slender design for working in confined areas. Drive unit only 3.5 kg, without die head. No heavy top, therefore single-hand operation possible. Perfect, secure seating of quick-change die heads.

### Drive

Solid, compact, maintenance-free gear. Robust, powerful 1200 W universal motor with 30 % power increase thanks to automatic carbon brush adjustment while changing the direction of rotation. Peak power input up to 1800 W. Fast threading time 35 – 27 rpm. Safety tip switch.

### Quick-change die heads

Proven technology, high-grade material and precise machining of die head, dies and cover form a unit and ensure an excellent start-cutting performance and easy threading. No stalling of dies. Long, precise pipe guidance for perfect pipe centering. The chip holes which become wider at the outside enable good chip flow and clean threads.

### Dies

The proven, indestructible REMS quality dies with precise cutting geometry ensure an excellent start-cutting performance, easy threading and clean threads. Dies in a high-quality special-grade steel, fully tempered and hardened, for extremely long die life.

### Thread-cutting oil

REMS Sanitol and REMS Spezial (page 47). Specially developed for threading. High cooling and lubricating effect. Essential for clean threads and longer service life of dies, tools and machines.

### Nipple-threading

Efficient with REMS Nippelspanner  $\frac{3}{8}$  –  $1\frac{1}{4}$ " (2") (page 46).



German Quality Product



Info

## Supply format

**REMS Amigo Set.** Electric die stock with quick-change die heads. For pipe threads  $\frac{1}{8}$  –  $1\frac{1}{4}$ " , 16 – 40 mm, bolt threads 6 – 30 mm,  $\frac{1}{4}$  – 1". For right and left-hand threads. Drive unit with maintenance-free gear, powerful universal motor 230 V or 110 V, 50 – 60 Hz, 1200 W, safety tip switch, power increase thanks to automatic carbon brush adjustment. Peak power input up to 1800 W. Right and left-hand rotation, overload protection switch. Support bracket for both directions. REMS eva quick-change die heads for pipe threads, tapered, ISO 7-1, EN 10226 (DIN 2999, BSPT) R right-hand respectively for threading electric conduit according to EN 60423 M. In sturdy steel case.

Description	Art.-No.	€
<b>Set R <math>\frac{1}{2}</math> + <math>\frac{3}{4}</math> + 1 + <math>1\frac{1}{4}</math></b>	530020R220	<b>1.100,28</b>
<b>Set M 16 + 20 + 25 + 32 (M x 1,5)</b>	530022R220	<b>1.162,56</b>
<b>Set M 20 + 25 + 32 + 40 (M x 1,5)</b>	530023R220	<b>1.245,60</b>

REMS Amigo Set for NPT threads available.

## Accessories

Description	Art.-No.	€
<b>Quick-change die heads, dies, attachment heads for button dies, see page 30 – 31.</b>		
<b>REMS Amigo drive unit</b>	530000R220	<b>621,76</b>
<b>Support bracket</b>	533000R	<b>165,04</b>
<b>REMS REG St <math>\frac{1}{4}</math> – 2"</b> , pipe deburrer, see page 97.	731700	<b>150,51</b>
<b>Dual purpose holder</b> for threading and sawing with REMS Amigo E, Amigo, Amigo 2 and REMS Tiger	543100	<b>264,69</b>
<b>Ratchet lever</b> see page 22.	522000	<b>168,16</b>
<b>Thread-cutting oil</b> see page 47.		
<b>REMS Nippelspanner <math>\frac{3}{8}</math> – 2"</b> see page 46.		
<b>Steel case</b> with inlay	536000	<b>110,03</b>



# REMS Amigo 2

Electric die stock with quick-change die heads

Powerful, easy-to-operate electric tool for threading with unique support bracket. Ready for use any-where, without vice. Ideal for repair, renovation, job site.

Pipe threads  $\frac{1}{8}$  – 2", 16 – 50 mm  
Bolt threads 6 – 30 mm,  $\frac{1}{4}$  – 1"

Thread types see page 30, 31.

## REMS Amigo 2 – extremely strong up to 2".

### System advantage

Only **one** type of small, compact quick-change die heads and only **one** type of dies for all REMS die stocks. Thus efficient and easy stocking. No confusion possible.

### Support bracket

Solid, easy to use, supports the die stock against torque in both directions. Secure clamping through angular clamping spindle with self-supporting effect. Very simple mounting of die stock onto support bracket and pipe.

### Design

Compact, robust, job site-proven. Can be used anywhere, even without vice. Slender design for working in confined areas. Drive unit only 6.5 kg, without die head.

### Drive

Solid, maintenance-free gear. Robust 1700 W universal motor with 30 % power increase thanks to automatic carbon brush adjustment while changing the direction of rotation. Fast threading time 30 – 18 rpm. Safety tip switch.

### Quick-change die heads

Proven technology, high-grade material and precise machining of die head, dies and cover form a unit and ensure an excellent start-cutting performance and easy threading. No stalling of dies. Long, precise pipe guidance for perfect pipe centering. The chip holes which become wider at the outside enable good chip flow and clean threads.

### Dies

The proven, indestructible REMS quality dies with precise cutting geometry ensure an excellent start-cutting performance, easy threading and clean threads. Dies in a high-quality special-grade steel, fully tempered and hardened, for extremely long die life.

### Thread-cutting oil

REMS Sanitol and REMS Spezial (page 47). Specially developed for threading. High cooling and lubricating effect. Essential for clean threads and longer service life of dies, tools and machines.

### Nipple-threading

Efficient with REMS Nippelspanner  $\frac{3}{8}$  – 1" (2") (page 46).



German Quality Product



Info



## Supply format

**REMS Amigo 2 Set.** Electric die stock with quick-change die heads. For pipe threads  $\frac{1}{8}$  – 2", 16 – 50 mm, bolt threads 6 – 30 mm,  $\frac{1}{4}$  – 1". For right and left-hand threads. Drive unit with maintenance-free gear, powerful universal motor 230 V or 110 V, 50 – 60 Hz, 1700 W, safety tip switch, power increase thanks to automatic carbon brush adjustment, right and left-hand rotation. Support bracket for both directions. REMS eva quick-change die heads for pipe threads, tapered, ISO 7-1, EN 10226 (DIN 2999, BSPT) R right-hand respectively for threading electric conduit according to EN 60423 M. In sturdy steel case.

Description	Art.-No.	€
<b>Set R <math>\frac{1}{2}</math> + <math>\frac{3}{4}</math> + 1 + 1<math>\frac{1}{4}</math> + 1<math>\frac{1}{2}</math> + 2</b>	540020R220	<b>1.743,84</b>
<b>Set M 20 + 25 + 32 + 40 + 50 (M x 1,5)</b>	540022R220	<b>1.889,16</b>

REMS Amigo 2 Set for NPT threads available.  
Other voltages on request.



## Accessories

Description	Art.-No.	€
<b>Quick-change die heads, dies, attachment heads for button dies, see page 30 – 31.</b>		
<b>REMS Amigo 2 drive unit</b>	540000R220	<b>1.100,28</b>
<b>Support bracket Amigo 2</b>	543000	<b>227,32</b>
<b>REMS REG St <math>\frac{1}{4}</math> – 2"</b> , pipe deburrer, see page 97.	731700	<b>150,51</b>
<b>Dual purpose holder</b> for threading and sawing with REMS Amigo E, Amigo, Amigo 2 and REMS Tiger	543100	<b>264,69</b>
<b>Ratchet lever</b> see page 22.	522000	<b>168,16</b>
<b>Thread-cutting oil</b> see page 47.		
<b>REMS Nippelspanner <math>\frac{3}{8}</math> – 2"</b> see page 46.		
<b>Steel case with inlay</b>	546000	<b>128,71</b>



# REMS Amigo 2 Compact

Electric die stock with quick-change die heads

Powerful, easy-to-operate electric tool for threading with unique support bracket. Ready for use any-where, without vice. Ideal for repair, renovation, job site.

Pipe threads  $\frac{1}{8}$  – 2", 16 – 50 mm  
Bolt threads 6 – 30 mm,  $\frac{1}{4}$  – 1"

Thread types see page 30, 31.

## REMS Amigo 2 Compact – The smallest and lightest up to 2".

### System advantage

Only **one** type of small, compact quick-change die heads and only **one** type of dies for all REMS die stocks. Thus efficient and easy stocking. No confusion possible.

### Support bracket

Solid, easy to use, supports the die stock against torque in both directions. Secure clamping through angular clamping spindle with self-supporting effect. Very simple mounting of die stock onto support bracket and pipe.

### Design

Compact, robust, job site-proven. Can be used anywhere, even without vice. Slender design for working in confined areas. Drive unit only 4.9 kg, without die head. Perfect seating of quick-change die heads.

### Drive

Solid, maintenance-free gear. Robust 1200 W universal motor with 30 % power increase thanks to automatic carbon brush adjustment while changing the direction of rotation. Peak power input up to 1800 W. Fast threading time 30 – 18 rpm. Safety tip switch.

### Quick-change die heads

Proven technology, high-grade material and precise machining of die head, dies and cover form a unit and ensure an excellent start-cutting performance and easy threading. No stalling of dies. Long, precise pipe guidance for perfect pipe centering. The chip holes which become wider at the outside enable good chip flow and clean threads.

### Dies

The proven, indestructible REMS quality dies with precise cutting geometry ensure an excellent start-cutting performance, easy threading and clean threads. Dies in a high-quality special-grade steel, fully tempered and hardened, for extremely long die life.

### Thread-cutting oil

REMS Sanitol and REMS Spezial (page 47). Specially developed for threading. High cooling and lubricating effect. Essential for clean threads and longer service life of dies, tools and machines.

### Nipple-threading

Efficient with REMS Nippelspanner  $\frac{3}{8}$  – 1" (2") (page 46).



German Quality Product



Info



## Supply format

**REMS Amigo 2 Compact Set.** Electric die stock with quick-change die heads. For pipe threads  $\frac{1}{8}$  – 2", 16 – 50 mm, bolt threads 6 – 30 mm,  $\frac{1}{4}$  – 1". For right and left-hand threads. Drive unit with maintenance-free gear, powerful universal motor 230 V or 110 V, 50 – 60 Hz, 1200 W, safety tip switch, power increase thanks to automatic carbon brush adjustment. Peak power input up to 1800 W. Right and left-hand rotation. Overload protection. Support bracket for both directions. REMS eva quick-change die heads for pipe threads, tapered, ISO 7-1, EN 10226 (DIN 2999, BSPT) R right-hand respectively for threading electric conduit according to DIN DN 60423 M. In sturdy steel case.

Description	Art.-No.	€
Set R $\frac{1}{2}$ + $\frac{3}{4}$ + 1 + 1 $\frac{1}{4}$	540023R220	1.598,52
Set R $\frac{1}{2}$ + $\frac{3}{4}$ + 1 + 1 $\frac{1}{4}$ + 1 $\frac{1}{2}$ + 2	540024R220	1.743,84
Set M 20 + 25 + 32 + 40 + 50 (M x 1,5)	540025R220	1.889,16

REMS Amigo 2 Compact Set for NPT threads available.

Other voltages on request.



## Accessories

Description	Art.-No.	€
<b>Quick-change die heads, dies, attachment heads for button dies, see page 30 – 31.</b>		
<b>REMS Amigo 2 Compact drive unit</b>	540001R220	1.100,28
<b>Support bracket Amigo 2 Compact</b>	543010	227,32
<b>REMS REG St <math>\frac{1}{4}</math> – 2"</b> , pipe deburrer, see page 97.	731700	150,51
<b>Ratchet lever</b> see page 22.	522000	168,16
<b>Thread-cutting oil</b> see page 47.		
<b>REMS Nippelspanner <math>\frac{3}{8}</math> – 2"</b> see page 46.		
<b>Steel case with inlay</b>	546000	128,71



# REMS Amigo 22V

Cordless die stock with quick-change die heads

Powerful, mobile, handy electric tool for threading with unique support bracket. Ready for use any-where, without vice. Ideal for repair, renovation, job site. Li-Ion 22V Technology. For battery and corded operation.

Pipe threads	1/8 – 1", 16 – 32 mm
Bolt threads	6 – 30 mm, 1/4 – 1"

Thread types see page 30, 31.

**REMS Amigo 22V – mobile, handy, light.**

**Li-Ion 21.6V, 9.0 Ah battery, for approx. 52 3/4" threads with one battery charge\*.**

## System advantage

Only **one** type of small, compact quick-change die heads and only **one** type of dies for all REMS die stocks. Thus efficient and easy stocking. No confusion possible.

## Support bracket

Solid, easy to use, supports the die stock against torque in both directions. Secure clamping through angular clamping spindle with self-supporting effect. Very simple mounting of die stock onto support bracket and pipe.

## Design

Compact, robust, job site-proven. Can be used anywhere, even without vice. Slender design for working in confined areas. Mobile, handy, light. Drive unit with battery pack weighs only 5.6 kg. Practical D-shaped handle with soft grip. Perfect seating of quick-change die heads. Machine status check with overload protection of the drive unit against too high currents, with overheating protection by motor temperature monitoring (NTC), with electronic battery charging status check by a 2-coloured green/red LED.

## Drive

Solid, maintenance-free gear. Powerful battery motor 21.6V, with large power reserve, 500W output. High cutting speed 27 – 20 rpm. Safety tip switch.

## Battery or mains operation

Li-Ion 22V Technology. Highly resistant Li-Ion 21.6V batteries with 9.0Ah capacity for long service life. Light and powerful, for 52 3/4" threads with one battery charge\*. Graduated charging status check by coloured LEDs. Operating temperature range –10 to +60 °C. No memory effect for maximum battery power. Rapid charger 100 – 240V, 90 W. Rapid charger 100 – 240V, 290 W, for shorter charging times, as accessory. Voltage supply 220 – 240V/21.6V, 40 A output, for mains operation instead of Li-Ion battery 21.6 V, as accessory.

## Quick-change die heads

Proven technology, high-grade material and precise machining of die head, dies and cover form a unit and ensure an excellent start-cutting performance and easy threading. No stalling of dies. Long, precise pipe guidance for perfect pipe centering. The chip holes which become wider at the outside enable good chip flow and clean threads.

## Dies

The proven, indestructible REMS quality dies with precise cutting geometry ensure an excellent start-cutting performance, easy threading and clean threads. Dies in a high-quality special-grade steel, fully tempered and hardened, for extremely long die life.

## Thread-cutting oil

REMS Sanitol and REMS Spezial (page 47). Specially developed for threading. High cooling and lubricating effect. Essential for clean threads and longer service life of dies, tools and machines.

## Nipple-threading

Efficient with REMS Nippelspanner 3/8 – 1" (2") (page 46).



German Quality Product



Info



## Supply format

**REMS Amigo 22V Set.** Cordless die stock with quick-change die heads. For pipe threads  $\frac{1}{8}$ –1", 16–32 mm, bolt threads 6–30 mm,  $\frac{1}{4}$ –1". For right and left-hand threads. Drive unit with maintenance-free gear, powerful battery motor 21.6V, 500 W. Safety switch. Right and left-hand rotation, machine status check with overload protection, temperature monitoring, battery charging status check. Li-Ion 21.6V, 9.0Ah battery, 100–240V, 50–60 Hz, 90 W rapid charger. Support bracket for both directions. REMS eva quick-change die heads for pipe threads, tapered, ISO 7-1, EN 10226 (DIN 2999, BSPT) R right-hand respectively for threading electric conduit according to DIN DN 60423 M. In sturdy steel case.

Description	Art.-No.	€
<b>Set R <math>\frac{1}{2}</math> + <math>\frac{3}{4}</math> + 1</b>	530015R220	<b>1.920,30</b>
<b>Set M 20 + 25 + 32</b>	530016R220	<b>1.992,96</b>

REMS Amigo 22V Set for NPT threads available.  
Other voltages on request.



## Accessories

Description	Art.-No.	€
<b>Quick-change die heads, dies, attachment heads for button dies, see page 30–31.</b>		
<b>REMS Akku-Amigo 22V drive unit, without battery</b>	530004R22	<b>1.162,56</b>
<b>Support bracket Amigo 2 Compact</b>	543010	<b>227,32</b>
<b>Battery Li-Ion 21.6V, 9.0 Ah</b>	571583R22	<b>414,16</b>
<b>Rapid charger 100–240V, 50–60 Hz, 90W</b>	571585R220	<b>175,42</b>
<b>Rapid charger 100–240V, 50–60 Hz, 290W</b>	571587R220	<b>414,16</b>
<b>Voltage supply 220–240V/21.6V, 50–60 Hz, 40 A, for mains operation instead of battery Li-Ion 21.6V</b>	571578R220	<b>517,96</b>
<b>REMS REG St <math>\frac{1}{4}</math>–2"</b> , pipe deburrer, see page 97.	731700	<b>150,51</b>
<b>Ratchet lever</b> see page 22.	522000	<b>168,16</b>
<b>Thread-cutting oil</b> see page 47.		
<b>REMS Nippelspanner <math>\frac{3}{8}</math>–2"</b> see page 46.		
<b>Steel case with inlay</b>	566030R	<b>128,71</b>
<b>REMS Lumen 2800 22V</b> , cordless LED flood light, see page 111		



# REMS quick-change die heads

Accessories for REMS die stocks and other makes

## REMS quick-change die heads

Proven technology, high-grade material and precise machining of die head, dies and cover form a unit and ensure an excellent start-cutting performance and easy threading. No stalling of dies. Long, precise pipe guidance for perfect pipe centering. The chip holes which become wider at the outside enable good chip flow and clean threads.

Thread type	Size	Art.-No.	€
Pipe threads R tapered, right-hand ISO 7-1, EN 10226 (DIN 2999, BSPT)	R 1/8	521000	<b>202,41</b>
	R 1/4	521010	<b>176,46</b>
	R 3/8	521020	<b>119,37</b>
	R 1/2	521030	<b>124,56</b>
	R 3/4	521040	<b>129,75</b>
	R 1	521050	<b>134,94</b>
	R 1 1/4	521060	<b>140,13</b>
	R 1 1/2	521070	<b>166,08</b>
	R 2	521080	<b>176,46</b>
Pipe threads R tapered, left-hand ISO 7-1, EN 10226 (DIN 2999, BSPT)	R 1/8 LH	521100	<b>242,89</b>
	R 1/4 LH	521110	<b>211,75</b>
	R 3/8 LH	521120	<b>143,24</b>
	R 1/2 LH	521130	<b>149,47</b>
	R 3/4 LH	521140	<b>155,70</b>
	R 1 LH	521150	<b>161,93</b>
	R 1 1/4 LH	521160	<b>168,16</b>
	R 1 1/2 LH	521170	<b>199,30</b>
Pipe threads NPT tapered, right-hand Taper Pipe Thread ASME B1.20.1	NPT 1/8	521200	<b>202,41</b>
NPT 1/4	521210	<b>176,46</b>	
NPT 3/8	521220	<b>119,37</b>	
NPT 1/2	521230	<b>124,56</b>	
NPT 3/4	521240	<b>129,75</b>	
NPT 1	521250	<b>134,94</b>	
NPT 1 1/4	521260	<b>140,13</b>	
NPT 1 1/2	521270	<b>166,08</b>	
NPT 2	521280	<b>176,46</b>	
Threads M for electric conduit EN 60423	M 16 x 1.5	521300	<b>155,70</b>
	M 20 x 1.5	521310	<b>155,70</b>
	M 25 x 1.5	521320	<b>161,93</b>
	M 32 x 1.5	521330	<b>168,16</b>
	M 40 x 1.5	521340	<b>199,30</b>
	M 50 x 1.5	521350	<b>211,75</b>



Right-hand pipe thread



Left-hand pipe thread

German Quality Product

# REMS dies

Accessories for REMS die stocks

## REMS dies

The proven, indestructible REMS quality dies with precise cutting geometry ensure an excellent start-cutting performance, easy threading and clean threads. Dies in a high-quality special-grade steel, fully tempered and hardened, for extremely long die life.

Thread type	Size	Art.-No.	€
Pipe threads R tapered, right-hand ISO 7-1, EN 10226 (DIN 2999, BSPT)	R 1/8	521002RWS	<b>92,38</b>
	R 1/4	521012RWS	<b>87,19</b>
	R 3/8	521022RWS	<b>87,19</b>
	R 1/2	521032RWS	<b>87,19</b>
	R 3/4	521042RWS	<b>95,50</b>
	R 1	521052RWS	<b>95,50</b>
	R 1 1/4	521062RWS	<b>95,50</b>
	R 1 1/2	521072RWS	<b>95,50</b>
	R 2	521082RWS	<b>95,50</b>
Pipe threads R tapered, left-hand ISO 7-1, EN 10226 (DIN 2999, BSPT)	R 1/8 LH	521102RWS	<b>111,07</b>
	R 1/4 LH	521112RWS	<b>104,84</b>
	R 3/8 LH	521122RWS	<b>104,84</b>
	R 1/2 LH	521132RWS	<b>104,84</b>
	R 3/4 LH	521142RWS	<b>115,22</b>
	R 1 LH	521152RWS	<b>115,22</b>
	R 1 1/4 LH	521162RWS	<b>115,22</b>
	R 1 1/2 LH	521172RWS	<b>115,22</b>
	R 2 LH	521182RWS	<b>114,18</b>
Pipe threads NPT tapered, right-hand Taper Pipe Thread ASME B1.20.1	NPT 1/8	521202RWS	<b>92,38</b>
	NPT 1/4	521212RWS	<b>87,19</b>
	NPT 3/8	521222RWS	<b>87,19</b>
	NPT 1/2	521232RWS	<b>87,19</b>
	NPT 3/4	521242RWS	<b>95,50</b>
	NPT 1	521252RWS	<b>95,50</b>
	NPT 1 1/4	521262RWS	<b>95,50</b>
	NPT 1 1/2	521272RWS	<b>95,50</b>
	NPT 2	521282RWS	<b>95,50</b>
Threads M for electric conduit EN 60423	M 16 x 1.5	521302RWS	<b>115,22</b>
	M 20 x 1.5	521312RWS	<b>115,22</b>
	M 25 x 1.5	521322RWS	<b>115,22</b>
	M 32 x 1.5	521332RWS	<b>115,22</b>
	M 40 x 1.5	521342RWS	<b>115,22</b>
	M 50 x 1.5	521352RWS	<b>114,60</b>



German Quality Product

## Attachment heads for button dies / intermediate rings / guide bushings

Accessories for REMS die stocks and other makes

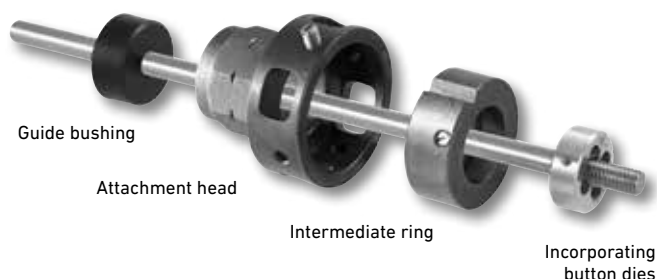

### Attachment heads

Attachment heads for incorporating standard, round button dies of all thread types. Locking of button dies to the attachment head with stud bolt.

Description	Size	Art.-No.	€
Attachment head for button dies	Ø 65 mm	731200	<b>152,59</b>
Attachment head for button dies	G 1¼	731250	<b>158,81</b>
Attachment head for button dies	Ø 105 mm	541401	<b>196,18</b>

### Intermediate rings

Intermediate rings for different outside diameters of button dies.

Description	Size	I.D. mm	Art.-No.	€
Intermediate rings to attachment head 731200	M 6-9	20/25	731205	<b>85,12</b>
	M 10-11	30	731210	<b>85,12</b>
	M 12-14 (Pg 7-9)	38	731220	<b>85,12</b>
	M 16-20 (Pg 11-13,5)	45	731230	<b>85,12</b>
	M 22-24 (Pg 16)	55	731240	<b>85,12</b>
without intermediate ring	M 27-30 (Pg 21-29)	65		
Intermediate rings to attachment head 541401	Ø 65/105 (Pg 21-29)	65	541404	<b>96,53</b>
	Ø 75/105	75	541406	<b>96,53</b>
	Ø 90/105 (Pg 36)	90	541410	<b>96,53</b>
without intermediate ring	Pg 42-48	105		

### Guide bushings

Guide bushings for easy and concentric start-cutting.

Description	Size	Art.-No.	€
Guide bushings to attachment head 731200	Ø 6	731301	<b>26,99</b>
	Ø 8	731302	<b>26,99</b>
	Ø 10	731303	<b>26,99</b>
	Ø 12	731304	<b>26,99</b>
	Ø 14	731305	<b>26,99</b>
	Ø 16	731306	<b>26,99</b>
	Ø 18	731307	<b>26,99</b>
	Ø 20	731308	<b>26,99</b>
	Ø 22	731309	<b>26,99</b>
	Ø 24	731310	<b>26,99</b>
	Ø 27	731311	<b>26,99</b>
	Ø 30	731312	<b>26,99</b>
	Ø 12.8 (Pg 7)	731320	<b>26,99</b>
	Ø 15.5 (Pg 9)	731321	<b>26,99</b>
	Ø 18.9 (Pg 11)	731322	<b>26,99</b>
	Ø 20.7 (Pg 13.5)	731323	<b>26,99</b>
	Ø 22.8 (Pg 16)	731324	<b>26,99</b>
Ø 28.6 (Pg 21)	731325	<b>26,99</b>	
Ø 37.3 (Pg 29)	731326	<b>26,99</b>	
Guide bushings to attachment head 541401	Ø 28.6 (Pg 21)	541413	<b>31,14</b>
	Ø 37.3 (Pg 29)	541414	<b>31,14</b>
	Ø 47.3 (Pg 36)	541415	<b>31,14</b>
	Ø 54.3 (Pg 42)	541416	<b>31,14</b>

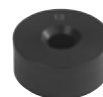

German Quality Product

Proven high performance machine for threading, cutting, deburring, threading of nipples, roll grooving.  
For installation, metalworking, industry.  
For job site and workshop.

Pipe threads	(1/16) 1/8–2", 16–63 mm
Bolt threads	(6) 10–60 mm, 1/4–2"

Thread types see page 40.

Pipe grooving with REMS roll grooving attachment	DN 25–200 1–8"
---	-------------------

### REMS Tornado – a class of its own.

**Automatic chuck. Universal automatic die head.**

**Automatic lubrication and cooling.**

#### Operating principle

Rotating material - stationary tools.

#### Design

Robust, job site-proven. Favourable size and weight, e.g. REMS Tornado 2000 complete only 50 kg. Large work and chip compartment. Easy handling of chip tray. Adjustable height material support.

#### 2 versions:

- Portable version with 3 tubular legs, with removable large oil basin and chip tray.
- Version T with integrated, even larger oil basin and chip tray. For workbench. Stand, collapsible wheel stand or wheel stand with material shelf, as an accessory, for easy transport, optimum working height and stable positioning.

#### Drive

Extremely powerful and fast, e.g. R 2" thread in only 15 s. Completely maintenance-free gear which runs in a sealed oil bath.

#### Choice of 3 powerful motors:

- Strong universal motor, 1700 W. overload protection. Spindle speed 53 rpm.
- Pole-reversible capacitor motor, 2100 W. Overload protection. 2 spindle speeds 52 and 26 rpm, also under full load. **Extremely quiet running.**
- Pole-reversible 3~induction motor, 2000 W. Overload protection. 2 spindle speeds 52 and 26 rpm, also under full load. **Extremely quiet running.**

Operator-friendly safety foot switch with emergency-stop, 2-step. Foot switch, can be loaded with the full body weight during operation.

#### Automatic chuck

2 automatic chucks with self-centering clamping jaws for easy and fast clamping and release of the material. Self-tightening, hence maximum clamping force. No slipping of pipes. Collets are available for clamping pipes <math>\varnothing 1/8''</math> and bolts <math>< \varnothing 10\text{ mm}</math>.

#### Automatic lubrication and cooling

Robust, proven oil pump with high pumping volume. Optimized oil distribution directly onto the threading point through the die head ensures clean threads and long service life of dies, gear and motor.

#### Universal automatic die head

Only **one** universal automatic die head for all threads, including long threads; automatic opening with automatic thread-length-stop for tapered threads. Fast and easy adjustment of thread size. Easy-to-read thread-size scale. Simple and fast change of dies through lock-in positioning in die holder.

#### Dies

The proven, indestructible REMS quality dies with precise cutting geometry ensure an excellent start-cutting performance, easy threading and clean threads. Dies in a high-quality special-grade steel, fully tempered and hardened, for extremely long die life.

#### Pipe cutter

Self centering. Robust body made of forged steel. Ergonomic, wide handle for powerful infeed of spindle. Specially hardened cutter wheel in tough-hard REMS die-steel ensures long service life.

#### Inner pipe deburrer

Robust, easy-to-handle deburring device with adjustable deburring positioning. Specially hardened and designed deburring blade ensures easy deburring and extremely long service life. Two cutting edges for optimum chip flow, specially for small diameters.

#### Thread-cutting oil

REMS Sanitol and REMS Spezial (page 47). Specially developed for threading. High cooling and lubricating effect. Essential for clean threads and longer service life of dies, tools and machines.

#### Nipple-threading

Efficient with the automatic internal clamping REMS Nippelfix 1/2–2" (4") or with the manual internal clamping REMS Nippelspanner 3/8–2" (page 46).

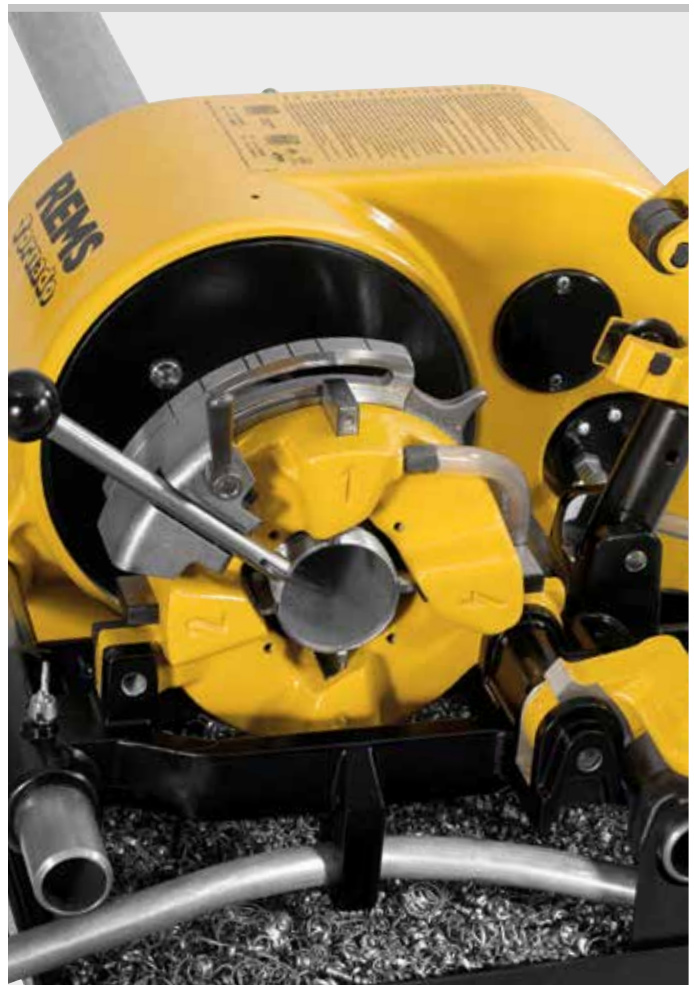

German Quality Product



Info



Choice of 3 powerful motors.





### REMS roll grooving attachment

Robust, compact roll grooving attachment with oil hydraulic in-feed for pipe grooving of grooved coupling systems DN 25–300, 1–12" (page 48).  
Roll grooving with REMS Tornado up to DN 200, 8".



Version T

Wheel stand (accessory)



Version T

Collapsible wheel stand (Accessory)

### Supply format

**REMS Tornado.** Threading machine for pipe threads ( $\frac{1}{16}$ – $\frac{1}{8}$ –2", 16–63 mm, bolt threads (6) 10–60 mm,  $\frac{1}{4}$ –2". With maintenance-free gear, safety foot switch with emergency-stop, 2 automatic chucks, automatic lubrication and cooling. With tool set consisting of one universal automatic die head for all threads, also long threads, automatic opening, with automatic thread-length-stop for tapered threads. Dies for pipe threads, tapered, ISO 7-1, EN 10226 (DIN 2999, BSPT) R  $\frac{1}{2}$ – $\frac{3}{4}$ " and R 1–2" right-hand, pipe cutter, inner pipe deburrer, pressing lever, adjustable height material support. Choice of 3 motors. Portable version with 3 tubular legs, with removable, large oil and chip tray. Version T with integrated, even bigger oil tray and chip tray, for workbench, stand, collapsible wheel stand or wheel stand with material shelf. In a carton.

Description	Version	Art.-No.	€
<b>2000</b>	Universal motor 230 V or 110 V, 50–60 Hz, 1700 W. 53 rpm. Portable, 3 legs.	340200R220	<b>4.660,62</b>
<b>2010</b>	Pole-reversible capacitor, motor 230 V, 50 Hz, 2100 W. 52/26 rpm, also under full load. Extremely quiet running. Portable, 3 legs.	340201R220	<b>4.795,56</b>
<b>2020</b>	Pole-reversible 3~ induction motor 400 V, 50 Hz, 2000 W. 52/26 rpm, also under full load. Extremely quiet running. Portable, 3 legs.	340202R380	<b>5.023,92</b>
<b>2000 T</b>	Universal motor 230 V or 110 V, 50–60 Hz, 1700 W. 53 rpm For work bench, stand or wheel stand.	340206R220	<b>5.646,72</b>
<b>2010 T</b>	Pole-reversible capacitor motor 230 V, 50 Hz, 2100 W. 52/26 rpm, also under full load. Extremely quiet running. For work bench, stand or wheel stand.	340207R220	<b>5.781,66</b>
<b>2020 T</b>	Pole-reversible 3~ induction motor 400 V, 50 Hz, 2000 W. 52/26 rpm, also under full load. Extremely quiet running. For work bench, stand or wheel stand.	340208R380	<b>6.010,02</b>

Other voltages and NPT versions on request.

### Accessories

Description	Art.-No.	€
<b>Stand</b>	344105R	<b>290,64</b>
<b>Wheel stand with material shelf</b>	344100R	<b>493,05</b>
<b>Collapsible wheel stand</b>	344150R	<b>705,84</b>
<b>Dies</b> see page 40.		
<b>Universal automatic die head <math>\frac{1}{16}</math>–2"</b> quick-change die head instead of changing the dies	341000RR	<b>778,50</b>
<b>REMS cutter wheel St <math>\frac{1}{8}</math>–4", s 8</b>	341614R	<b>15,47</b>
<b>Thread-cutting oil</b> see page 47.		
<b>Nipple holder</b> see page 46.		
<b>REMS Herkules material supports</b> , see page 107.		
<b>REMS roll grooving attachment</b> for pipe grooving, see page 48.	347000R	<b>2.242,08</b>



Robust, compact high performance machine for threading, cutting, deburring, threading of nipples, roll grooving. For installation, metalworking, industry. For job site and workshop.

Pipe threads (1/16) 1/8–2", 16–63 mm

Bolt threads (6) 8–60 mm, 1/4–2"

Thread types see page 40.

Grooving of pipes with

REMS roll grooving attachment DN 25–300  
1–12"

### REMS Magnum – the compact up to 2".

#### Operating principle

Rotating material – stationary tools.

#### Design

Robust, compact, job site-proven design. Favorable size and weight, e.g. REMS Magnum 2000 L-T only 62 kg. Large work and chip compartment. Tool support.

#### 2 versions:

- Light version L-T with removable large oil basin and chip tray.
  - Version T with integrated, even larger oil basin and chip tray.
- For workbench. Stand, collapsible wheel stand or wheel stand with material shelf, as an accessory, for easy transport, optimum working height and stable positioning.

#### Drive

Extremely powerful and fast, e.g. thread R 2" in only 15 s. Completely maintenance-free gear which runs in a sealed oil bath.

#### Choice of 3 powerful motors:

- Strong universal motor, 1700 W.  
Overload protection. Spindle speed 53 rpm.
- Pole-reversible capacitor motor, 2100 W.  
Overload protection. 2 spindle speeds 52 and 26 rpm, also under full load. **Extremely quiet running.**
- Pole-reversible 3~ induction motor, 2000 W.  
Overload protection. 2 spindle speeds 52 and 26 rpm, also under full load. **Extremely quiet running.**

Operator-friendly safety foot switch with emergency-stop, 2-step. Foot switch, can be loaded with the full body weight during operation.

#### Chuck

Proven quick-action hammer chuck, self-tightening. No slipping of pipes. Large space between chuck and centering device ensures secure clamping of long pipes. Rear centering device for alignment of the material. Collets are available for clamping pipes <math>\lt; \varnothing 1/2''</math> and bolts <math>\lt; \varnothing 8\text{ mm}</math>.

#### Automatic lubrication and cooling

Robust, proven oil pump with high pumping volume. Optimized oil distribution directly onto the threading point through the die head ensures clean threads and long service life of dies, gear and motor.

#### Universal automatic die head

Only **one** universal automatic die head for all threads, including long threads; automatic opening with automatic thread-length-stop for tapered threads. Fast and easy adjustment of thread size. Simple and fast change of dies through lock-in positioning in die holder.

#### Dies

The proven, indestructible REMS quality dies with precise cutting geometry ensure an excellent start-cutting performance, easy threading and clean threads. Dies in a high-quality special-grade steel, fully tempered and hardened, for extremely long die life.

#### Pipe cutter

Self centering. Robust body made of forged steel. Ergonomic, wide handle for powerful infeed of spindle. Specially hardened cutter wheel in tough-hard REMS die-steel ensures long service life.

#### Inner pipe deburrer

Robust, easy-to-handle deburring device for adjustable deburring positioning. Specially hardened and designed deburring blade ensures easy deburring and extremely long service life. Two cutting edges for optimum chip flow, specially for small diameters.

#### Thread-cutting oil

REMS Sanitol and REMS Spezial (page 47). Specially developed for threading. High cooling and lubricating effect. Essential for clean threads and longer service life of dies, tools and machines.

#### Nipple-threading

Efficient with automatic internal clamping REMS Nippelfix 1/2–2" (4") or with manual internal clamping REMS Nippelspanner 3/8–2" (page 46).

#### REMS roll grooving attachment

Robust, compact roll grooving attachment with oil hydraulic in-feed for pipe grooving of grooved coupling systems DN 25–300, 1–12" (page 48).



German Quality Product



Info



Choice of 3 powerful motors.





### Supply format

**REMS Magnum.** Threading machine for pipe threads ( $\frac{1}{16}$ )  $\frac{1}{8}$ –2", 16–63 mm, bolt thread (6) 8–60 mm,  $\frac{1}{4}$ –2". With maintenance-free gear, safety foot switch with emergency-stop, self-tightening quick-action hammer chuck, rear centering device, automatic lubrication and cooling. With complete tool set consisting of one universal automatic die head for all threads, also long threads; automatic opening, with automatic thread-length-stop for tapered threads, dies for pipe threads, tapered, ISO 7-1, EN 10226 (DIN 2999, BSPT) R  $\frac{1}{2}$ – $\frac{3}{4}$ " and R 1–2" right-hand, pipe cutter, inner pipe deburrer, pressing lever. Tool support. Choice of 3 motors. Version L-T with removable large oil basin and chip tray. Version T with integrated, even bigger oil tray and chip tray. For workbench, stand, collapsible wheel stand or wheel stand with material shelf. In a carton.

Description	Version	Art.-No.	€
<b>2000 L-T</b>	Universal motor 230 V or 110 V, 50–60 Hz, 1700 W. 53 rpm.	340226R220	<b>4.712,52</b>
<b>2010 L-T</b>	Pole-reversible capacitor motor 230 V, 50 Hz, 2100 W. 52/26 rpm, also under full load. Extremely quiet running.	340227R220	<b>5.117,34</b>
<b>2020 L-T</b>	Pole-reversible 3~ induction motor 400 V, 50 Hz, 2000 W. 52/26 rpm, also under full load. Extremely quiet running.	340228R380	<b>5.273,04</b>
<b>2000 T*</b>	Universal motor 230 V or 110 V, 50–60 Hz, 1700 W. 53 rpm.	340220R220	<b>5.646,72</b>
<b>2010 T*</b>	Pole-reversible capacitor motor 230 V, 50 Hz, 2100 W. 52/26 rpm, also under full load. Extremely quiet running.	340221R220	<b>6.051,54</b>
<b>2020 T*</b>	Pole-reversible 3~ induction motor 400 V, 50 Hz, 2000 W. 52/26 rpm, also under full load. Extremely quiet running.	340222R380	<b>6.207,24</b>

Other voltages and NPT versions on request.

\*T versions with REMS roll grooving device for roll grooving can only be used up to DN 200, 8".

### Accessories

Description	Art.-No.	€
<b>Stand</b>	344105R	<b>290,64</b>
<b>Wheel stand with material shelf</b>	344100R	<b>493,05</b>
<b>Collapsible wheel stand</b>	344150R	<b>705,84</b>
<b>Dies</b> see page 40.		
<b>Universal automatic die head <math>\frac{1}{16}</math>–2"</b> quick-change die head instead of changing the dies	341000RR	<b>778,50</b>
<b>Changeover valve</b> , for reversing flow direction of the coolant-lubricant pump for cutting left-handed threads with REMS Magnum 2010, 2020, 3010, 3020, 4010 and 4020	342080RX	<b>143,24</b>
<b>REMS cutter wheel St <math>\frac{1}{8}</math>–4", s 8</b>	341614R	<b>15,47</b>
<b>Thread-cutting oil</b> see page 47.		
<b>Nipple holder</b> see page 46.		
<b>REMS Herkules material supports</b> , see page 107.		
<b>REMS roll grooving attachment</b> for pipe grooving, see page 48.	347000R	<b>2.242,08</b>



Robust, compact high performance machine for threading, cutting, deburring, threading of nipples, roll grooving. For installation, metalworking, industry. For job site and workshop.

Pipe threads (1/16) 1/2–3", 16–63 mm  
Bolt threads (6) 18–60 mm, 1/2–2"

Thread types see page 40.

Pipe grooving with REMS roll grooving attachment DN 25–300  
1–12"

**REMS Magnum – the super machine up to 3". Exceptionally round and clean threads up to 3" by using 5 threading dies.**

### Operating principle

Rotating material – stationary tools.

### Design

Robust, compact, job site-proven design. Favorable size and weight, e.g. REMS Magnum 3000 L-T only 79 kg. Large work and chip compartment. Tool support.

#### 2 versions:

- Light version L-T with removable large oil basin and chip tray.
  - Version T with integrated, even larger oil basin and chip tray.
- For workbench. Stand, collapsible wheel stand or wheel stand with material shelf, as an accessory, for easy transport, optimum working height and stable positioning.

### Drive

Extremely powerful and fast. Completely maintenance-free gear which runs in a sealed oil bath.

#### Choice of 3 powerful motors:

- Strong universal motor, 1700 W.  
Overload protection. Spindle speed 23 rpm.
- Pole-reversible capacitor motor, 2100 W.  
Overload protection. 2 spindle speeds 20 and 10 rpm, also under full load. **Extremely quiet running.**
- Pole-reversible 3~ induction motor, 2000 W.  
Overload protection. 2 spindle speeds 20 and 10 rpm, also under full load. **Extremely quiet running.**

Operator-friendly safety foot switch with emergency-stop, 2-step. Foot switch, can be loaded with the full body weight during operation.

### Chuck

Proven quick-action hammer chuck, self-tightening. No slipping of pipes. Large space between chuck and centering device ensures secure clamping of long pipes. Rear centering device for alignment of the material. Collets are available for clamping pipes <math>\varnothing</math> 1/2" and bolts <math>\varnothing</math> 18 mm.

### Automatic lubrication and cooling

Robust, proven oil pump with high pumping volume. Optimized oil distribution directly onto the threading point through the die head ensures clean threads and long service life of dies, gear and motor.

### Universal automatic die head

Only 1 universal automatic die head each for the sizes 1/16–2" and 2 1/2–3" for all threads, including long threads; automatic opening with automatic thread-length-stop for tapered threads. 5 dies 2 1/2–3" ensure a favourable distribution of the cutting force onto the pipe, hence round and clean threads. Fast and easy adjustment of thread size. Simple and fast change of dies through lock-in positioning in die holder.

### Dies

The proven, indestructible REMS quality dies with precise cutting geometry ensure an excellent start-cutting performance, easy threading and clean threads. Dies in a high-quality special-grade steel, fully tempered and hardened, for extremely long die life.

### Pipe cutter

Self centering. Robust body made of forged steel. Ergonomic, wide handle for powerful infeed of spindle. Specially hardened cutter wheel in tough-hard REMS die-steel ensures long service life.

### Inner pipe deburrer

Robust, easy-to-handle deburring device for adjustable deburring positioning. Specially hardened and designed deburring blade ensures easy deburring and extremely long service life. Two cutting edges for optimum chip flow, specially for small diameters.

### Tool sets

For 2 1/2–3" and 1/2–2" one complete tool set each adapted to the work range with universal die head, pipe cutter, inner-pipe-deburring device, pressing lever, dies.



German Quality Product



Choice of 3 powerful motors.



### Thread-cutting oil

REMS Sanitol and REMS Spezial (page 47). Specially developed for threading. High cooling and lubricating effect. Essential for clean threads and longer service life of dies, tools and machines.

### Nipple-threading

Efficient with automatic internal clamping REMS Nippelfix ½–3" (4") or with manual internal clamping REMS Nippelspanner (page 46).

### REMS roll grooving attachment

Robust, compact roll grooving attachment with oil hydraulic in-feed for pipe grooving of grooved coupling systems DN 25–300, 1–12" (page 48).

### Supply format

**REMS Magnum.** Threading machine for pipe threads (1/16) ½–3", 16–63 mm, bolt threads (6) 18–60 mm, ½–2". With maintenance-free gear, safety foot switch with emergency-stop, self-tightening quick-action hammer chuck, rear centering device, automatic lubrication and cooling. With tool sets 1/16–2" and/or 2½–3", each consisting of universal automatic die head for all threads, also long threads; automatic opening, with automatic thread-length-stop for tapered threads, dies for pipe threads, tapered, ISO 7-1, EN 10226 (DIN 2999, BSPT) R right-hand, pipe cutter, inner pipe deburrer, pressing lever. Tool support. Choice of 3 motors. Version L-T with removable large oil basin and chip tray. Version T with integrated, even larger oil basin and chip tray. For workbench, stand, collapsible wheel stand or wheel stand with material shelf. In a carton.

Description	Version/Equipment	Art.-No.	€
<b>3000 L-T</b>	Universal motor 230 V or 110 V, 50–60 Hz, 1700 W. 23 rpm.	380303R220	<b>5.625,96</b>
	<b>Equipment R 2½–3</b> <b>Equipment R ½–3</b>	380309R220	<b>6.923,46</b>
<b>3010 L-T</b>	Pole-reversible capacitor motor 230 V, 50 Hz, 2100 W. 20/10 rpm, also under full load. Extremely quiet running.	380304R220	<b>5.926,98</b>
	<b>Equipment R 2½–3</b> <b>Equipment R ½–3</b>	380310R220	<b>7.224,48</b>
<b>3020 L-T</b>	Pole-reversible 3~ induction motor 400 V, 50 Hz, 2000 W. 20/10 rpm, also under full load. Extremely quiet running.	380305R380	<b>6.144,96</b>
	<b>Equipment R 2½–3</b> <b>Equipment R ½–3</b>	380311R380	<b>7.442,46</b>
<b>3000 T*</b>	Universal motor 230 V or 110 V, 50–60 Hz, 1700 W. 23 rpm.	380306R220	<b>6.560,16</b>
	<b>Equipment R 2½–3</b> <b>Equipment R ½–3</b>	380312R220	<b>7.857,66</b>
<b>3010 T*</b>	Pole-reversible capacitor motor 230 V, 50 Hz, 2100 W. 20/10 rpm, also under full load. Extremely quiet running.	380307R220	<b>6.861,18</b>
	<b>Equipment R 2½–3</b> <b>Equipment R ½–3</b>	380313R220	<b>8.158,68</b>
<b>3020 T*</b>	Pole-reversible 3~ induction motor 400 V, 50 Hz, 2000 W. 20/10 rpm, also under full load. Extremely quiet running.	380308R380	<b>7.079,16</b>
	<b>Equipment R 2½–3</b> <b>Equipment R ½–3</b>	380314R380	<b>8.376,66</b>

Other voltages and NPT versions on request.

\*T versions with REMS roll grooving device for roll grooving can only be used up to DN 200, 8".

### Accessories

Description	Art.-No.	€
<b>Stand</b>	344105R	<b>290,64</b>
<b>Wheel stand with material shelf</b>	344100R	<b>493,05</b>
<b>Collapsible wheel stand</b>	344150R	<b>705,84</b>
<b>Dies see page 40.</b>		
<b>Tool set R ½–2" complete</b> with universal automatic die head 1/16–2", dies for pipe threads, tapered, ISO 7-1, EN 10226 (DIN 2999, BSPT) R ½–¾" and R 1–2" right-hand, pipe cutter, inner pipe deburrer, pressing lever.	340100RR	<b>1.297,50</b>
<b>Universal automatic die head 1/16–2" and others</b>	341000RR	<b>778,50</b>
<b>Universal automatic die head 2½–3"</b>	381050R	<b>1.027,62</b>
<b>Universal automatic die head 2½–4"</b>	381000R	<b>1.816,50</b>
<b>Changeover valve</b> , for reversing flow direction of the coolant-lubricant pump for cutting left-handed threads with REMS Magnum 2010, 2020, 3010, 3020, 4010 and 4020	342080RX	<b>143,24</b>
<b>REMS cutter wheel St 1/8–4", s 8</b>	341614R	<b>15,47</b>
<b>REMS cutter wheel St 1–4", s 12</b>	381622R	<b>35,60</b>
<b>Thread-cutting oil see page 47.</b>		
<b>Nipple holder see page 46.</b>		
<b>REMS Herkules material supports, see page 107.</b>		
<b>REMS roll grooving attachment</b> for pipe grooving, see page 48.	347000R	<b>2.242,08</b>

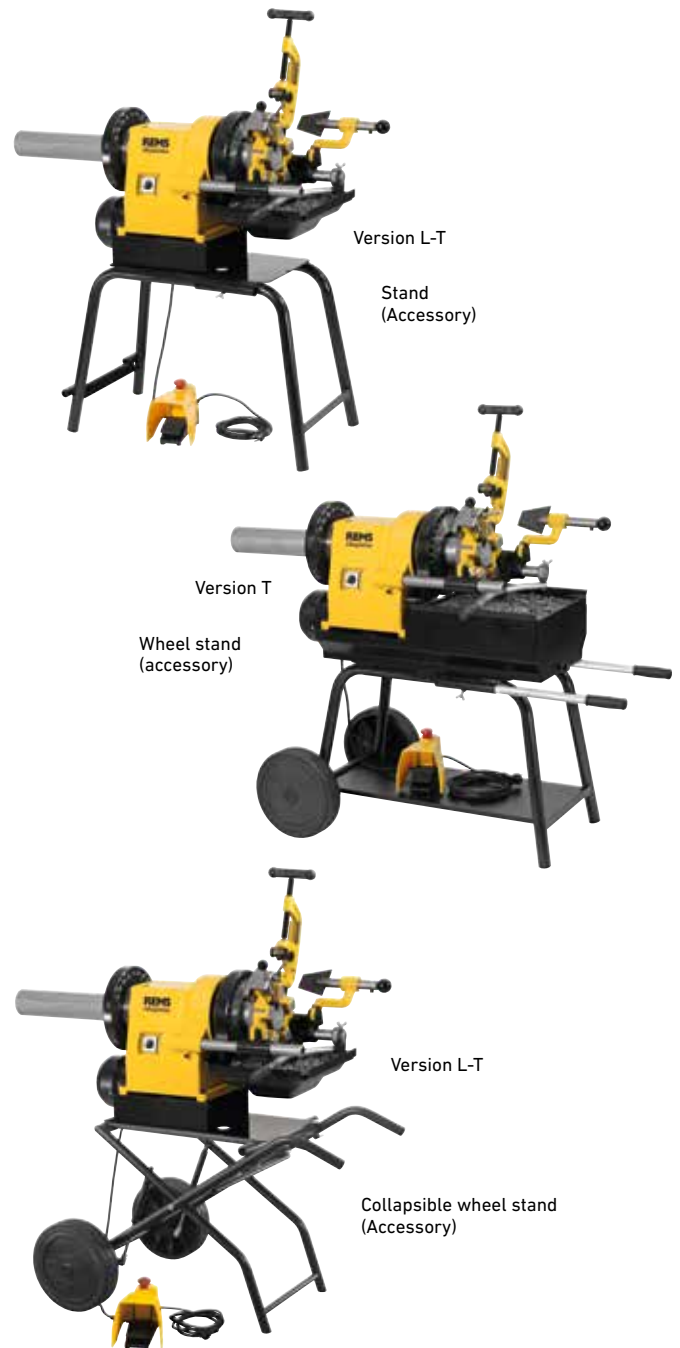

Robust, compact high performance machine for threading, cutting, deburring, threading of nipples, roll grooving. For installation, metalworking, industry. For job site and workshop.

Pipe threads (1/16) 1/2–4", 18–63 mm  
Bolt threads (6) 20–60 mm, 1/2–2"

Thread types see page 40.

Pipe grooving with REMS roll grooving attachment DN 25–300  
1–12"

**REMS Magnum – the super machine up to 4". Exceptionally round and clean threads up to 4" by using 6 threading dies.**

### Operating principle

Rotating material - stationary tools.

### Design

Robust, compact, job site-proven design. Favorable size and weight, e.g. REMS Magnum 4000 L-T only 81 kg. Large work and chip compartment. Tool support.

#### 2 versions:

- Light version L-T with removable large oil basin and chip tray.
  - Version T with integrated, even larger oil basin and chip tray.
- For workbench. Stand, collapsible wheel stand or wheel stand with material shelf, as an accessory, for easy transport, optimum working height and stable positioning.

### Drive

Extremely powerful and fast. Completely maintenance-free gear which runs in a sealed oil bath.

#### Choice of 3 powerful motors:

- Strong universal motor, 1700 W. Overload protection. Spindle speed 23 rpm.
- Pole-reversible capacitor motor, 2100 W. Overload protection. 2 spindle speeds 20 and 10 rpm, also under full load. **Extremely quiet running.**
- Pole-reversible 3~ induction motor, 2000 W. Overload protection. 2 spindle speeds 20 and 10 rpm, also under full load. **Extremely quiet running.**

Operator-friendly safety foot switch with emergency-stop, 2-step. Foot switch, can be loaded with the full body weight during operation.

### Chuck

Proven quick-action hammer chuck, self-tightening. No slipping of pipes. Large space between chuck and centering device ensures secure clamping of long pipes. Rear centering device for alignment of the material. Collets are available for clamping pipes <math>\varnothing 1/2''</math> and bolts <math>\varnothing 18\text{ mm}</math>.

### Automatic lubrication and cooling

Robust, proven oil pump with high pumping volume. Optimized oil distribution directly onto the threading point through the die head ensures clean threads and long service life of dies, gear and motor.

### Universal automatic die head

Only 1 universal automatic die head each for the sizes 1/16–2" and 2 1/2–4" for all threads, including long threads; automatic opening with automatic thread-length-stop for tapered threads. 6 dies 2 1/2–4" ensure a favourable distribution of the cutting force onto the pipe, hence round and clean threads. Fast and easy adjustment of thread size. Simple and fast change of dies through lock-in positioning in die holder.

### Dies

The proven, indestructible REMS quality dies with precise cutting geometry ensure an excellent start-cutting performance, easy threading and clean threads. Dies in a high-quality special-grade steel, fully tempered and hardened, for extremely long die life.

### Pipe cutter

Self centering. Robust body made of forged steel. Ergonomic, wide handle for powerful infeed of spindle. Specially hardened cutter wheel in tough-hard REMS die-steel ensures long service life.

### Inner pipe deburrer

Robust, easy-to-handle deburring device for adjustable deburring positioning. Specially hardened and designed deburring blade ensures easy deburring and extremely long service life. Two cutting edges for optimum chip flow, specially for small diameters.

### Tool sets

For 2 1/2–4" and 1/2–2" one complete tool set each adapted to the work range with universal die head, pipe cutter, inner-pipe-deburring device, pressing lever, dies.



German Quality Product



Info



Choice of 3 powerful motors.



### Thread-cutting oil

REMS Sanitol and REMS Spezial (page 47). Specially developed for threading. High cooling and lubricating effect. Essential for clean threads and longer service life of dies, tools and machines.

### Nipple-threading

Efficient with automatic internal clamping REMS Nippelfix ½–4" or with manual internal clamping REMS Nippelspanner ¾–2" (page 46).

### REMS roll grooving attachment

Robust, compact roll grooving attachment with oil hydraulic in-feed for pipe grooving of grooved coupling systems DN 25–300, 1–12" (page 48).

### Supply format

**REMS Magnum.** Threading machine for pipe threads (1/16) ½–4", 16–63 mm, bolt threads (6) 18–60 mm, ½–2". With maintenance-free gear, safety foot switch with emergency-stop, self-tightening quick-action hammer chuck, rear centering device, automatic lubrication and cooling. With tool sets 1/16–2" and/or 2 1/2–4", each consisting of universal automatic die head for all threads, also long threads; automatic opening, with automatic thread-length-stop for tapered threads, dies for pipe threads, tapered, ISO 7-1, EN 10226 (DIN 2999, BSPT) R right-hand, pipe cutter, inner pipe deburrer, pressing lever. Tool support. Choice of 3 motors. Version L-T with removable large oil basin and chip tray. Version T with integrated, even larger oil basin and chip tray. For workbench, stand, collapsible wheel stand or wheel stand with material shelf. In a carton.

Description	Version/Equipment	Art.-No.	€
<b>4000 L-T</b>	Universal motor 230 V or 110 V, 50–60 Hz, 1700 W. 23 rpm.		
	<b>Equipment R ½–2</b>	380447 R220	<b>5.397,60</b>
	<b>Equipment R 2 1/2–4</b>	380441 R220	<b>6.466,74</b>
	<b>Equipment R ½–4</b>	380444 R220	<b>7.764,24</b>
<b>4010 L-T</b>	Pole-reversible capacitor motor 230 V, 50 Hz, 2100 W. 20/10 rpm, also under full load. Extremely quiet running.		
	<b>Equipment R ½–2</b>	380448 R220	<b>5.698,62</b>
	<b>Equipment R 2 1/2–4</b>	380442 R220	<b>6.767,76</b>
	<b>Equipment R ½–4</b>	380445 R220	<b>8.065,26</b>
<b>4020 L-T</b>	Pole-reversible 3~ induction motor 400 V, 50 Hz, 2000 W. 20/10 rpm, also under full load. Extremely quiet running.		
	<b>Equipment R 2 1/2–4</b>	380443 R380	<b>6.985,74</b>
	<b>Equipment R ½–4</b>	380446 R380	<b>8.283,24</b>
<b>4000 T*</b>	Universal motor 230 V or 110 V, 50–60 Hz, 1700 W. 23 rpm.		
	<b>Equipment R 2 1/2–4</b>	380426 R220	<b>7.400,94</b>
	<b>Equipment R ½–4</b>	380429 R220	<b>8.698,44</b>
<b>4010 T*</b>	Pole-reversible capacitor motor 230 V, 50 Hz, 2100 W. 20/10 rpm, also under full load. Extremely quiet running.		
	<b>Equipment R 2 1/2–4</b>	380427 R220	<b>7.701,96</b>
	<b>Equipment R ½–4</b>	380430 R220	<b>8.999,46</b>
<b>4020 T*</b>	Pole-reversible 3~ induction motor 400 V, 50 Hz, 2000 W. 20/10 rpm, also under full load. Extremely quiet running.		
	<b>Equipment R 2 1/2–4</b>	380428 R380	<b>7.919,94</b>
	<b>Equipment R ½–4</b>	380431 R380	<b>9.217,44</b>

Other voltages and NPT versions on request.

\*T versions with REMS roll grooving device for roll grooving can only be used up to DN 200, 8".

### Accessories

Description	Art.-No.	€
<b>Stand</b>	344105R	<b>290,64</b>
<b>Wheel stand with material shelf</b>	344100R	<b>493,05</b>
<b>Collapsible wheel stand</b>	344150R	<b>705,84</b>
<b>Dies see page 40.</b>		
<b>Tool set R ½–2" complete</b> with universal automatic die head 1/16–2", dies for pipe threads, tapered, ISO 7-1, EN 10226 (DIN 2999, BSPT) R ½–¾" and R 1–2" right-hand, pipe cutter, inner pipe deburrer, pressing lever.	340100RR	<b>1.297,50</b>
<b>Universal automatic die head 1/16–2" and others</b>	341000RR	<b>778,50</b>
<b>Universal automatic die head 2 1/2–4"</b>	381000R	<b>1.816,50</b>
<b>Changeover valve</b> , for reversing flow direction of the coolant-lubricant pump for cutting left-handed threads with REMS Magnum 2010, 2020, 3010, 3020, 4010 and 4020	342080RX	<b>143,24</b>
<b>REMS cutter wheel St 1/8–4", s 8</b>	341614R	<b>15,47</b>
<b>REMS cutter wheel St 1–4", s 12</b>	381622R	<b>35,60</b>
<b>Thread-cutting oil</b> see page 47.		
<b>Nipple holder</b> see page 46.		
<b>REMS Herkules material supports</b> , see page 107.		
<b>REMS roll grooving attachment</b> for pipe grooving, see page 48.	347000R	<b>2.242,08</b>



## REMS dies (set)

The proven REMS quality dies with precise cutting geometry ensure an excellent start-cutting performance, easy threading and clean threads. Dies in a high-quality special-grade steel, fully tempered and hardened, for materials < 500 N/mm<sup>2</sup> (MPa) for extremely long die life.

Dies for other threads (e.g. BSW) on request. HSS dies for materials that are difficult to cut ≥ 500 N/mm<sup>2</sup> (MPa) 50 % surcharge.

<sup>1)</sup> Some dies only available in HSS.

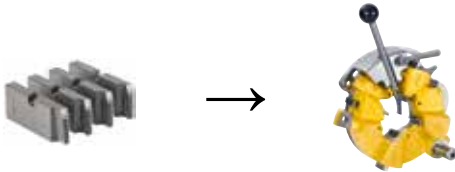

### For universal automatic die head 1/16 – 2"

Thread type	Size	Art.-No.	€
Pipe threads R tapered, right-hand ISO 7-1, EN 10226 (DIN 2999, BSPT)	R 1/16 – 1/8 HSS <sup>1)</sup>	341401RHSS	<b>492,01</b>
	R 1/4 – 3/8	341402RWS	<b>328,01</b>
	R 1/2 – 3/4	341403RWS	<b>328,01</b>
	R 1 – 2	341404RWS	<b>328,01</b>
Pipe threads G parallel, right-hand ISO 228-1 (DIN 259, BSPP)	G 1/16 – 1/8	341406RWS	<b>373,68</b>
	G 1/4 – 3/8	341407RWS	<b>373,68</b>
	G 1/2 – 3/4	341408RWS	<b>373,68</b>
	G 1 – 2	341409RWS	<b>373,68</b>
Pipe threads NPT tapered, right-hand Taper Pipe Thread ASME B1.20.1	NPT 1/16 – 1/8 HSS <sup>1)</sup>	341411RHSS	<b>492,01</b>
	NPT 1/4 – 3/8	341412RWS	<b>328,01</b>
	NPT 1/2 – 3/4	341413RWS	<b>328,01</b>
	NPT 1 – 2	341414RWS	<b>328,01</b>
Pipe threads NPSM parallel, right-hand Straight Pipe Thread ASME B1.20.1	NPSM 1/8	341416RWS	<b>373,68</b>
	NPSM 1/4 – 3/8	341417RWS	<b>373,68</b>
	NPSM 1/2 – 3/4 HSS <sup>1)</sup>	341418RHSS	<b>560,52</b>
	NPSM 1 – 2 HSS <sup>1)</sup>	341419RHSS	<b>560,52</b>
Conduit threads Pg DIN 40430	Pg 7	341466RWS	<b>373,68</b>
	Pg 9	341467RWS	<b>373,68</b>
	Pg 11	341468RWS	<b>373,68</b>
	Pg 13.5	341469RWS	<b>373,68</b>
	Pg 16	341470RWS	<b>373,68</b>
	Pg 21	341471RWS	<b>373,68</b>
	Pg 29	341472RWS	<b>373,68</b>
	Pg 36	341473RWS	<b>373,68</b>
	Pg 42	341474RWS	<b>373,68</b>
Conduit threads M EN 60423	M 16 x 1.5	341493RWS	<b>373,68</b>
	M 20 x 1.5	341494RWS	<b>373,68</b>
	M 25 x 1.5	341495RWS	<b>373,68</b>
	M 32 x 1.5	341496RWS	<b>373,68</b>
	M 40 x 1.5	341497RWS	<b>373,68</b>
	M 50 x 1.5	341498RWS	<b>373,68</b>
Metric bolt threads M ISO 261 (DIN 13)	M 6	341426RWS	<b>373,68</b>
	M 8	341427RWS	<b>373,68</b>
	M 10	341428RWS	<b>373,68</b>
	M 12	341429RWS	<b>373,68</b>
	M 14	341430RWS	<b>373,68</b>
	M 16	341431RWS	<b>373,68</b>
	M 18	341432RWS	<b>373,68</b>
	M 20	341433RWS	<b>373,68</b>
	M 22	341434RWS	<b>373,68</b>
	M 24	341435RWS	<b>373,68</b>
	M 27	341436RWS	<b>373,68</b>
	M 30	341437RWS	<b>373,68</b>
	M 33	341438RWS	<b>404,82</b>
	M 36	341439RWS	<b>404,82</b>
	M 39	341440RWS	<b>404,82</b>
	M 42	341441RWS	<b>404,82</b>
	M 45	341442RWS	<b>404,82</b>
	M 48	341443RWS	<b>404,82</b>
	M 52	341444RWS	<b>404,82</b>
	M 56 HSS <sup>1)</sup>	341445RHSS	<b>607,23</b>
M 60 HSS <sup>1)</sup>	341446RHSS	<b>607,23</b>	
Bolt threads UNC Unified Inch Screw Thread ASME B1.1	UNC 1/4 – 20 HSS <sup>1)</sup>	341476RHSS	<b>560,52</b>
	UNC 5/16 – 18	341477RWS	<b>373,68</b>
	UNC 3/8 – 16 HSS <sup>1)</sup>	341478RHSS	<b>560,52</b>
	UNC 7/16 – 14	341479RWS	<b>373,68</b>
	UNC 1/2 – 13 HSS <sup>1)</sup>	341480RHSS	<b>560,52</b>
	UNC 9/16 – 12	341481RWS	<b>373,68</b>
	UNC 5/8 – 11 HSS <sup>1)</sup>	341482RHSS	<b>492,01</b>
	UNC 3/4 – 10 HSS <sup>1)</sup>	341483RHSS	<b>492,01</b>
	UNC 7/8 – 9 HSS <sup>1)</sup>	341484RHSS	<b>492,01</b>
	UNC 1 – 8 HSS <sup>1)</sup>	341485RHSS	<b>492,01</b>
	UNC 1 1/8 – 7	341486RWS	<b>328,01</b>
	UNC 1 1/4 – 7 HSS <sup>1)</sup>	341487RHSS	<b>492,01</b>
	UNC 1 3/8 – 6	341488RWS	<b>404,82</b>
	UNC 1 1/2 – 6 HSS <sup>1)</sup>	341489RHSS	<b>607,23</b>
UNC 1 3/4 – 5	341490RWS	<b>328,01</b>	
UNC 2 – 4.5	341491RWS	<b>328,01</b>	

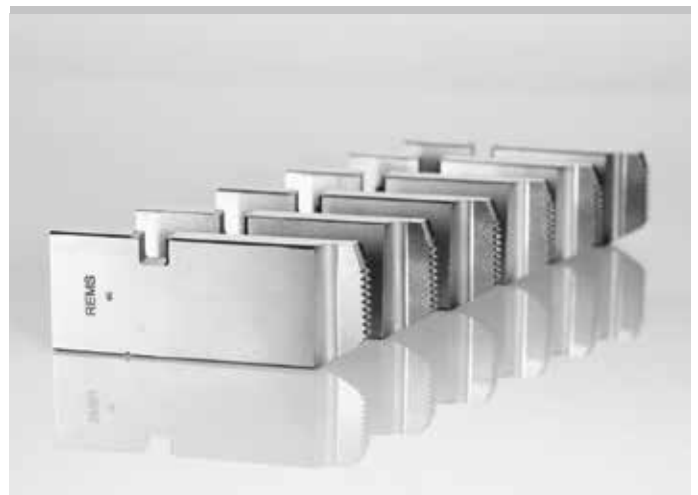

German Quality Product

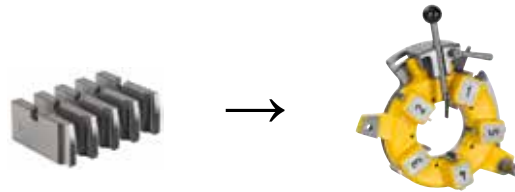

### For universal automatic die head 2 1/2 – 3"

Thread type	Size	Art.-No.	€
Pipe threads R tapered, right-hand ISO 7-1, EN 10226 (DIN 2999, BSPT)	R 2 1/2 – 3	381430RWS	<b>456,72</b>
Pipe threads G parallel, right-hand ISO 228-1 (DIN 259, BSPP)	G 2 1/2 – 3 HSS <sup>1)</sup>	381431RHSS	<b>739,06</b>
Pipe threads NPT tapered, right-hand Taper Pipe Thread ASME B1.20.1	NPT 2 1/2 – 3 HSS <sup>1)</sup>	381432RHSS	<b>685,08</b>
Pipe threads NPSM parallel, right-hand Straight Pipe Thread ASME B1.20.1	NPSM 2 1/2 – 3 HSS <sup>1)</sup>	381433RHSS	<b>739,06</b>

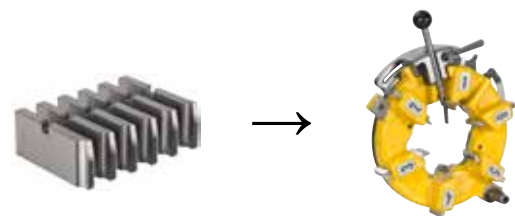

### For universal automatic die head 2 1/2 – 4"

Thread type	Size	Art.-No.	€
Pipe threads R tapered, right-hand ISO 7-1, EN 10226 (DIN 2999, BSPT)	R 2 1/2 – 4	381401RWS	<b>689,23</b>
Pipe threads G parallel, right-hand ISO 228-1 (DIN 259, BSPP)	G 2 1/2 – 4 HSS <sup>1)</sup>	381405RHSS	<b>1.098,20</b>
Pipe threads NPT tapered, right-hand Taper Pipe Thread ASME B1.20.1	NPT 2 1/2 – 4 HSS <sup>1)</sup>	381410RHSS	<b>1.033,85</b>
Pipe threads NPSM parallel, right-hand Straight Pipe Thread ASME B1.20.1	NPSM 2 1/2 – 4 HSS <sup>1)</sup>	381415RHSS	<b>1.098,20</b>





**REMS**  
Unimat 75

Semi-automatic high-performance machine for efficient cutting of bolt and pipe threads. For industry, metalworking, installation.

Bolt threads	6 – 72 mm 1/4 – 2 3/4"	
Pipe threads	1/16 – 2 1/2", 16 – 63 mm	
Tolerance class corresponding to ISO 261 (DIN 13)	"medium" (6 g)	
Thread length	≤ Ø 30 mm	unlimited
	≤ Ø 72 mm	≤ 200 mm
Chamfering	Range	7 – 62 mm
	Chamfered Ø	≥ 7 mm
	Maximum chamfer	7 mm
	Chamfer angle	45°
Peeling	Range	7 – 62 mm
	Peeled Ø	≥ 7 mm

Thread types see page 44.

**REMS Unimat 75 – high efficiency. Tangential-chaser-threading-system. Large threading range. Fast working, short resetting time. For single and series production. Low hourly rate for the machine. Simple operation. Relieves expensive turning machines and specialists.**

### Operating principle

Stationary material – rotating die head.

### Design

Compact, rugged design for continuous use. Die head with regrindable tangential chasers in self centering holder system. After start-cutting with feed lever and rack mechanism self feeding action of die head (no guide thread). Welded, sturdy machine stand with large oil compartment and removeable chip drawer.

### Drive

Indestructible planetary gear with annulus gear for long threads up to Ø 30 mm. Proven and powerful pole-reversible three-phase motor, specially designed for threading, with hollow shaft, 2000/2300 W. Overload protection. Reverse switch for cutting right and left-hand threads. High operating speed, 2 spindle speeds 70 and 35 rpm.

### Clamping device

Self-centering universal vice for the complete range with specially toothed and hardened clamping jaws. Choice of manual or hydraulic clamping with operation by foot switch (working pressure 6 bar).

### Special clamping jaws

For drawn material, stud bolts, hex screws and pipe nipples, as accessory.

### Automatic lubrication and cooling

Robust, proven oil pump with high pumping volume. Ample oil volume ensures longer service life of chasers, gear and motor.

### Universal automatic die head

Only **one** universal automatic die head for all threads. Fine adjustment of thread diameter with spindle and scale. Die head closes automatically and opens automatically when the required thread length is reached. After starting the thread via feed lever and rack the chaser-system initiates an automatic feed-forward of the die head. All threads can be cut in a single pass. Copying unit for tapered threads. Instead of changing the dies, additional quick-change die heads ensure shorter resetting time.

### Chasers

The proven regrindable REMS tangential chasers with precise cutting geometry ensure an excellent start-cutting performance and clean threads. Tool steel chasers made of special hardened steel for material < 500 N/mm<sup>2</sup> (MPa). HSS chasers for hard-to-machine material ≥ 500 N/mm<sup>2</sup> (MPa). The chasers sit in a special holder system. Chasers and holders together form a threading set.

### Thread cutting on rebar

Special chaser dies M with additional, ground cut for cutting threads on rebar in a single pass. Driven by REMS Unimat 75 with oil-hydraulic/pneumatic vice, for high clamping pressure.



German Quality Product

Machining examples



Info



### Thread-cutting oil

REMS Sanitol and REMS Spezial (page 47). Specially developed for threading. High cooling and lubricating effect. Essential for clean threads and longer service life of dies, tools and machines.

### Nipple-threading

Efficient with special clamping jaws  $\frac{1}{16}$ – $1\frac{1}{4}$ " or with the automatic internal clamping REMS Nippelfix  $\frac{1}{2}$ – $2\frac{1}{2}$ " or with the manual internal clamping REMS Nippelspanner  $\frac{3}{8}$ – $2$ " (page 46).



### Supply format

**REMS Unimat 75 Basic.** Semi-automatic threading machine for bolt threads 6–72 mm,  $\frac{1}{4}$ – $2\frac{3}{4}$ ", pipe threads  $\frac{1}{16}$ – $2\frac{1}{2}$ ", 16–63 mm. Machine on stand. Pole-reversible 3~ induction motor with hollow shaft, 400 V, 50 Hz, 2000/2300 W, right and left-hand rotation. Die head speed 70 and 35 rpm. Self-centering universal chuck for the complete clamping range, choice of manual or oil-hydraulic/pneumatic operation. Automatic lubrication and cooling. 1 universal automatic die head for all threads, opens and closes automatically. Without threading sets, without closing lever. Electric locking system of safety cover. Adjustment gauge. Wrench. In transport case.

Description	Version	Art.-No.	€
<b>REMS Unimat 75 Basic mS</b>	manual clamping device	750003R380	<b>21.964,08</b>
<b>REMS Unimat 75 Basic pS</b>	oil-hydraulic/pneumatic vice clamping device	750004R380	<b>25.794,30</b>

Other voltages on request.

### Accessories

Description	Art.-No.	€
<b>Chasers and holders (threading sets) and chasers</b> see page 44.		
<b>Universal automatic die head,</b> without threading sets, without closing lever	751000	<b>1.348,36</b>
<b>Closing lever</b> for closing and opening the chasers		
<b>R</b> for taper pipe threads, right-hand	751040R90	<b>176,46</b>
<b>R-L</b> for taper pipe threads, left-hand	751050R90	<b>176,46</b>
<b>G</b> for cylindrical pipe threads, right-hand	751060R90	<b>176,46</b>
<b>G-L</b> for cylindrical pipe threads, left-hand	751070R90	<b>176,46</b>
<b>M</b> for all bolt threads, right-hand	751080R90	<b>176,46</b>
<b>M-L</b> for all bolt threads, left-hand	751090R90	<b>176,46</b>
<b>Chamfering/peeling die head 45°, Ø 7–62 mm,</b> with chamfering/peeling chasers 45°, Ø 7–62 mm, HSS, with holder	751100	<b>3.316,41</b>
<b>Chamfering/peeling die head 45°, Ø 7–62 mm,</b> without threading sets	751102	<b>1.404,41</b>
<b>Chamfering/peeling chasers 45°, Ø 7–46 mm,</b> HSS, with holder	751096	<b>956,00</b>
<b>Chamfering/peeling chasers 45°, Ø 40–62 mm,</b> HSS, with holder	751098	<b>956,00</b>
<b>Chamfering/peeling chasers 45°, Ø 7–62 mm,</b> pack of 4, with holder	751097	<b>552,63</b>
<b>Special clamping jaws, pair,</b> for drawn material, stud bolts and hex screws. Workpiece length protrude from vice without thread, minimum 15 mm, Ø 6–42 mm	753240	<b>1.432,44</b>

**Thread-cutting oil** see page 47.

**Nipple holder** see page 46.

**REMS Herkules material supports,** see page 107.





German Quality Product



German Quality Product

### Chasers and holders (threading set)

The proven regrindable REMS tangential chasers with precise cutting geometry ensure an excellent start-cutting performance and clean threads. Tool steel chasers made of special hardened steel for material < 500 N/mm<sup>2</sup> (MPa).

HSS chasers for hard-to-machine material ≥ 500 N/mm<sup>2</sup> (MPa). The chasers sit in a special holder system. Chasers and holders together form a threading set.

Thread type	Size	Art.-No.	€
Pipe threads R tapered, right-hand ISO 7-1, EN 10226 (DIN 2999, BSPT)	R 1/16 - 1/8	759250RWS	<b>817,94</b>
	R 1/4 - 3/8	759251RWS	<b>817,94</b>
	R 1/2 - 3/4	759252RWS	<b>817,94</b>
	R 1 - 2	759253RWS	<b>817,94</b>
	R 2 1/2	759254RWS	<b>817,94</b>
Pipe threads G parallel, right-hand ISO 228-1 (DIN 259, BSPP)	G 1/16 - 1/8	759255RWS	<b>817,94</b>
	G 1/4 - 3/8 HSS <sup>1)</sup>	759256RHSS	<b>1.004,78</b>
	G 1/2 - 3/4 HSS <sup>1)</sup>	759257RHSS	<b>1.004,78</b>
	G 1 - 2 HSS <sup>1)</sup>	759258RHSS	<b>1.004,78</b>
Pipe threads NPT tapered, right-hand Taper Pipe Thread ASME B1. 20.1	NPT 1/16 - 1/8	759360RWS	<b>817,94</b>
	NPT 1/4 - 3/8 HSS <sup>1)</sup>	759361RHSS	<b>1.004,78</b>
	NPT 1/2 - 3/4 HSS <sup>1)</sup>	759362RHSS	<b>1.004,78</b>
	NPT 1 - 2 HSS <sup>1)</sup>	759363RHSS	<b>1.004,78</b>
Pipe threads NPSM parallel, right-hand Straight Pipe Thread ASME B1. 20.1	NPSM 1/16 - 1/8	759365RWS	<b>817,94</b>
	NPSM 1/4 - 3/8	759366RWS	<b>817,94</b>
	NPSM 1/2 - 3/4 HSS <sup>1)</sup>	759367RHSS	<b>1.004,78</b>
	NPSM 1 - 2 HSS <sup>1)</sup>	759368RHSS	<b>1.004,78</b>
Conduit threads Pg DIN 40430	Pg 7	759260RWS	<b>817,94</b>
	Pg 9 - 16	759261RWS	<b>817,94</b>
	Pg 21 - 48	759262RWS	<b>817,94</b>
Conduit threads M EN 60423	M 16 - 20 x 1.5	759263RWS	<b>817,94</b>
	M 25 - 32 x 1.5	759264RWS	<b>817,94</b>
	M 40 - 50 x 1.5	759265RWS	<b>817,94</b>
	M 63 x 1.5 HSS <sup>1)</sup>	759330RHSS	<b>1.004,78</b>
Threads M for rebar ISO 261 (DIN 13)	M 14 - 16 HSS	759274RHSSZ	<b>1.004,78</b>
	M 18 - 22 HSS	759275RHSSZ	<b>1.004,78</b>
	M 24 - 27 HSS	759276RHSSZ	<b>1.004,78</b>
	M 30 - 33 HSS	759277RHSSZ	<b>1.004,78</b>
	M 36 - 39 HSS	759278RHSSZ	<b>1.126,23</b>
	M 42 - 45 HSS	759279RHSSZ	<b>1.126,23</b>
Metric bolt threads M ISO 261 (DIN 13)	M 6 HSS <sup>1)</sup>	759270RHSS	<b>1.004,78</b>
	M 8	759271RWS	<b>817,94</b>
	M 10	759272RWS	<b>817,94</b>
	M 12	759273RWS	<b>817,94</b>
	M 14 - 16	759274RWS	<b>817,94</b>
	M 18 - 22	759275RWS	<b>817,94</b>
	M 24 - 27	759276RWS	<b>817,94</b>
	M 30 - 33	759277RWS	<b>817,94</b>
	M 36 - 39	759278RWS	<b>903,06</b>
	M 42 - 45	759279RWS	<b>903,06</b>
	M 48 - 52 HSS <sup>1)</sup>	759280RHSS	<b>1.126,23</b>
	M 56 - 60 HSS <sup>1)</sup>	759281RHSS	<b>1.126,23</b>
	M 64 - 72 HSS <sup>1)</sup>	759282RHSS	<b>1.126,23</b>
	Bolt threads UNC Unified Inch Screw Thread ASME B1.1	UNC 1/4 - 20	759370RWS
UNC 5/16 - 18		759371RWS	<b>817,94</b>
UNC 3/8 - 16		759372RWS	<b>817,94</b>
UNC 7/16 - 14		759373RWS	<b>817,94</b>
UNC 1/2 - 13		759374RWS	<b>817,94</b>
UNC 5/8 - 12		759375RWS	<b>817,94</b>
UNC 3/4 - 11		759376RWS	<b>817,94</b>
UNC 7/8 - 10		759377RWS	<b>817,94</b>
UNC 1 - 8		759378RWS	<b>817,94</b>
UNC 1 - 8 HSS <sup>1)</sup>		759379RHSS	<b>1.004,78</b>
UNC 1 1/8 - 7		759380RWS	<b>817,94</b>
UNC 1 1/4 - 6		759381RWS	<b>903,06</b>
UNC 1 3/8 - 5		759382RWS	<b>903,06</b>
UNC 2 - 2 1/4 - 4.5		759383RWS	<b>903,06</b>
UNC 2 1/2 - 2 3/4 - 4		759384RWS	<b>903,06</b>

Dies for other threads (e.g. bicycle threads, fine threads, BSW) and HSS chaser dies for materials above 500 N/mm<sup>2</sup> (MPa) that are difficult to cut on request. Dies with HSS chaser dies with 50% surcharge on chaser dies. <sup>1)</sup> Some chasers only available in HSS. Threading sets for left-hand threads 50% extra charge on chasers.

### Chasers (set)

The proven regrindable REMS tangential chasers with precise cutting geometry ensure an excellent start-cutting performance and clean threads. Tool steel chasers made of special hardened steel for material < 500 N/mm<sup>2</sup> (MPa).

HSS chasers for hard-to-machine material ≥ 500 N/mm<sup>2</sup> (MPa).

Thread type	Size	Art.-No.	€	
Pipe threads R tapered, right-hand ISO 7-1, EN 10226 (DIN 2999, BSPT)	R 1/16 - 1/8	751501RWS	<b>373,68</b>	
	R 1/4 - 3/8	751502RWS	<b>373,68</b>	
	R 1/2 - 3/4	751503RWS	<b>373,68</b>	
	R 1 - 2 1/2	751504RWS	<b>373,68</b>	
Pipe threads G parallel, right-hand ISO 228-1 (DIN 259, BSPP)	G 1/16 - 1/8 HSS <sup>1)</sup>	751505RHSS	<b>560,52</b>	
	G 1/4 - 3/8	751506RHSS	<b>560,52</b>	
	G 1/2 - 3/4 HSS <sup>1)</sup>	751507RHSS	<b>560,52</b>	
Pipe threads NPT tapered, right-hand Taper Pipe Thread ASME B1. 20.1	NPT 1/16 - 1/8	751544RWS	<b>373,68</b>	
	NPT 1/4 - 3/8 HSS <sup>1)</sup>	751545RHSS	<b>560,52</b>	
	NPT 1/2 - 3/4 HSS <sup>1)</sup>	751546RHSS	<b>560,52</b>	
Pipe threads NPSM parallel, right-hand Straight Pipe Thread ASME B1. 20.1	NPSM 1/16 - 1/8	751549RWS	<b>373,68</b>	
	NPSM 1/4 - 3/8	751550RWS	<b>373,68</b>	
	NPSM 1/2 - 3/4 HSS <sup>1)</sup>	751551RHSS	<b>560,52</b>	
Conduit threads Pg DIN 40430	Pg 7	751509RWS	<b>373,68</b>	
	Pg 9 - 16	751510RWS	<b>373,68</b>	
	Pg 21 - 48	751511RWS	<b>373,68</b>	
Conduit threads M EN 60423	M 16 - 63 x 1.5 (M 10)	751518RWS	<b>373,68</b>	
	Threads M for rebar ISO 261 (DIN 13)	M 14 - 16 HSS	751520RHSSZ	<b>560,52</b>
Threads M for rebar ISO 261 (DIN 13)	M 18 - 22 HSS	751521RHSSZ	<b>560,52</b>	
	M 24 - 27 HSS	751522RHSSZ	<b>560,52</b>	
	M 30 - 33 HSS	751523RHSSZ	<b>560,52</b>	
	M 36 - 39 HSS	751524RHSSZ	<b>669,51</b>	
	M 42 - 45 HSS	751525RHSSZ	<b>669,51</b>	
	Metric bolt threads M ISO 261 (DIN 13)	M 6	751516RHSS	<b>560,52</b>
Bolt threads UNC Unified Inch Screw Thread ASME B1.1	M 8	751517RWS	<b>373,68</b>	
	M 10 (M 16 - 63 x 1.5)	751518RWS	<b>373,68</b>	
	M 12	751519RWS	<b>373,68</b>	
	M 14 - 16	751520RWS	<b>373,68</b>	
	M 18 - 22	751521RWS	<b>373,68</b>	
	M 24 - 27	751522RWS	<b>373,68</b>	
	M 30 - 33	751523RWS	<b>373,68</b>	
	M 36 - 39	751524RWS	<b>446,34</b>	
	M 42 - 45	751525RWS	<b>446,34</b>	
	M 48 - 52	751526RWS	<b>446,34</b>	
	M 56 - 60	751527RWS	<b>446,34</b>	
	M 64 - 72	751528RWS	<b>446,34</b>	
	Bolt threads UNC Unified Inch Screw Thread ASME B1.1	UNC 1/4 - 20	751557RWS	<b>373,68</b>
		UNC 5/16 - 18	751558RWS	<b>373,68</b>
UNC 3/8 - 16		751559RWS	<b>373,68</b>	
UNC 7/16 - 14		751560RWS	<b>373,68</b>	
UNC 1/2 - 13		751561RWS	<b>373,68</b>	
UNC 5/8 - 12		751562RWS	<b>373,68</b>	
UNC 3/4 - 11		751563RWS	<b>373,68</b>	
UNC 7/8 - 10		751564RWS	<b>373,68</b>	
UNC 1 - 8		751565RWS	<b>373,68</b>	
UNC 1 - 8 HSS <sup>1)</sup>		751566RHSSZ	<b>560,52</b>	
UNC 1 1/8 - 7		751567RWS	<b>373,68</b>	
UNC 1 1/4 - 6		751568RWS	<b>446,34</b>	
UNC 1 3/8 - 5		751569RWS	<b>446,34</b>	
UNC 2 - 2 1/4 - 4.5		751570RWS	<b>446,34</b>	
UNC 2 1/2 - 2 3/4 - 4	751571RWS	<b>446,34</b>		

Chaser dies for other threads (e.g. bicycle threads, fine threads, BSW) and HSS chaser dies for materials above 500 N/mm<sup>2</sup> (MPa) that are difficult to cut on request. HSS chaser dies with 50% surcharge. <sup>1)</sup> Some chasers only available in HSS. Chasers for left-hand threads 50% extra charge.

# Thread tables

## Taper Pipe Threads

Whitworth Pipe Thread ISO 7-1, EN 10226 (DIN 2999, BSPT) External thread taper 1:16 Flank angle 55°		
Nominal Size <b>R</b> <b>BSPT</b>	Outside Ø of thread mm	T.P.I.
1/16	7.723	28
1/8	9.728	28
1/4	13.157	19
3/8	16.662	19
1/2	20.955	14
3/4	26.441	14
1	33.249	11
1 1/4	41.910	11
1 1/2	47.803	11
2	59.614	11
2 1/2	75.184	11
3	87.884	11
4	113.030	11

Standard Taper Pipe Thread NPT, ASME B 1.20.1 External thread taper 1:16 Flank angle 60°		
Nominal Size <b>NPT</b>	Outside Ø of thread mm	T.P.I.
1/16	7.938	27
1/8	10.287	27
1/4	13.716	18
3/8	17.145	18
1/2	21.336	14
3/4	26.670	14
1	33.401	11.5
1 1/4	42.164	11.5
1 1/2	48.260	11.5
2	60.325	11.5
2 1/2	73.025	8
3	88.900	8
3 1/2	101.600	8
4	114.300	8

## Parallel Pipe Threads

Whitworth Pipe Thread ISO 228-1 (DIN 259, BSPP) External thread parallel Flank angle 55°		
Nominal Size <b>G</b> <b>BSPP</b>	Outside Ø of thread mm	T.P.I.
1/16	7.723	28
1/8	9.728	28
1/4	13.157	19
3/8	16.662	19
1/2	20.955	14
3/4	26.441	14
1	33.249	11
1 1/4	41.910	11
1 1/2	47.803	11
2	59.614	11
2 1/2	75.184	11
3	87.884	11
3 1/2	100.330	11
4	113.030	11

Straight Pipe Thread for Fixtures NPSM, ASME B 1.20.1 External thread parallel Flank angle 60°		
Nominal Size <b>NPSM</b>	Outside Ø of thread mm	T.P.I.
1/8	10.083	27
1/4	13.360	18
3/8	16.815	18
1/2	20.904	14
3/4	26.264	14
1	32.842	11.5
1 1/4	41.605	11.5
1 1/2	47.676	11.5
2	59.715	11.5
2 1/2	72.161	8
3	88.062	8
3 1/2	100.787	8
4	113.436	8

## Metric Bolt Thread

Metric ISO Thread ISO 261 (DIN 13) External thread Flank angle 60°		
Nominal Size <b>M</b>	Outside Ø of thread mm	Pitch mm
6	5.974	1
8	7.972	1.25
10	9.968	1.5
12	11.966	1.75
14	13.962	2
16	15.962	2
18	17.958	2.5
20	19.958	2.5
22	21.958	2.5
24	23.952	3
27	26.952	3
30	29.947	3.5
33	32.947	3.5
36	35.940	4
39	38.940	4
42	41.937	4.5
45	44.937	4.5
48	47.929	5
52	51.929	5
56	55.925	5.5
60	59.925	5.5
64	63.920	6
68	67.920	6
72	71.920	6

## American and British Bolt Threads

Unified Inch Screw Thread UNC, ASME B 1.1 External thread Flank angle 60°		
Nominal Size <b>UNC</b>	Outside Ø of thread mm	T.P.I.
1/4	6.322	20
5/16	7.907	18
3/8	9.491	16
7/16	11.076	14
1/2	12.661	13
9/16	14.246	12
5/8	15.834	11
3/4	19.004	10
7/8	22.176	9
1	25.349	8
1 1/8	28.519	7
1 1/4	31.694	7
1 3/8	34.864	6
1 1/2	38.039	6
1 3/4	44.381	5
2	50.726	4.5
2 1/4	57.076	4.5
2 1/2	63.421	4
2 3/4	69.768	4

British Standard Parallel Screw Thread of Whitworth Form <b>B.S.W.</b> BS 84 (obsolete): External thread Flank angle 55°		
Nominal Size <b>BSW</b>	Outside Ø of thread mm	T.P.I.
1/4	6.350	20
5/16	7.937	18
3/8	9.525	16
7/16	11.112	14
1/2	12.700	12
5/8	15.875	11
3/4	19.050	10
7/8	22.225	9
1	25.400	8
1 1/8	28.575	7
1 1/4	31.750	7
1 1/2	38.100	6
1 3/4	44.450	5
2	50.800	4.5
2 1/4	57.150	4
2 1/2	63.500	4
2 3/4	69.850	3.5

## Threads for Electric Conduit

Conduit Thread DIN 40 430 External thread parallel Flank angle 80°		
Nominal Size <b>Pg</b>	Outside Ø of thread mm	T.P.I.
7	12.5	20
9	15.2	18
11	18.6	18
13.5	20.4	18
16	22.5	18
21	28.3	16
29	37	16
36	47	16
42	54	16
48	59.3	16

Conduit Thread EN 60423 External thread parallel Flank angle 60°		
Nominal Size <b>M</b>	Outside Ø of thread mm	Pitch mm
16	15.968	1.5
20	19.968	1.5
25	24.968	1.5
32	31.968	1.5
40	39.968	1.5
50	49.968	1.5
63	62.968	1.5

Outside diameter of thread is always the maximum diameter, for taper pipe threads this is measured at the scale line.

# REMS Nippelspanner

Accessories for threading machines and hand die stocks of all types and makes

Manual pipe nipple chuck for internal clamping of short pipe pieces. For universal use.

Nipples and double nipples in standard and special lengths 3/8 – 2"

## REMS Nippelspanner – efficient nipple-threading. Any length. Anywhere.

To be used universally for threading machines and for hand die stocks of all types and makes. For opening and non-opening die heads. Ideal accessory for REMS Amigo E, REMS Amigo, REMS Amigo 2, REMS Amigo 2 Compact, REMS Amigo 22V, REMS eva and other makes.

Ideal tool for using up short pipe pieces. Saves time and money.

Chucking and centering of pipe pieces by expanding of specially hardened spring steel segments.

Internal clamping, so no thread required for clamping.

### Supply format

**REMS Nippelspanner.** Manual pipe nipple chuck for internal clamping of short pipe pieces.

Description	Size	Art.-No.	€
<b>REMS Nippelspanner</b>	3/8"	110000R	<b>126,64</b>
	1/2"	110100R	<b>146,36</b>
	3/4"	110200R	<b>167,12</b>
	1"	110300R	<b>229,40</b>
	1 1/4"	110400R	<b>271,96</b>
	1 1/2"	110500R	<b>323,86</b>
	2"	110600R	<b>396,52</b>

### Supply format

**REMS Nippelspanner Set.** Manual pipe nipple chuck for internal clamping of short pieces of pipe. In sturdy steel case.

Description	Art.-No.	€
<b>Set 1/2 + 3/4 + 1 + 1 1/4"</b>	110620R	<b>761,89</b>
<b>Set 1/2 + 3/4 + 1 + 1 1/4 + 1 1/2 + 2"</b>	110621R	<b>1.375,35</b>

# REMS Nippelfix

Automatic pipe nipple chuck for internal clamping of short pipe pieces.

Nipples and double nipples in standard and special lengths 1/2 – 4"

## REMS Nippelfix – efficient nipple-threading up to 4". Any length. Anywhere. Automatic internal clamping. Super fast and simple.

For threading machines with opening die head: Pipe turning machines, machines with rotating die head, threading devices.

Ideal tool for using up short pipe pieces. Saves time and money.

Automatic quick-chuck and centering of pipe piece. No tools.

Automatic release after completion of nipple. Production of nipples possible without taking the Nippelfix out of the clamping device.

Internal clamping, so no thread required for clamping.

Specially hardened and ground clamping jaws for fast and safe clamping.

### Supply format

**REMS Nippelfix.** Automatic pipe nipple chuck for internal clamping of short pipe pieces.

Description	Size	Art.-No.	€
<b>REMS Nippelfix</b>	1/2"	111000R	<b>106,91</b>
	3/4"	111100R	<b>127,67</b>
	1"	111200R	<b>165,04</b>
	1 1/4"	111300R	<b>200,33</b>
	1 1/2"	111400R	<b>231,47</b>
	2"	111500R	<b>270,92</b>
	2 1/2"	111700R	<b>373,68</b>
	3"	111800R	<b>482,67</b>
	4"	111900R	<b>517,96</b>

### Supply format

**REMS Nippelfix Set.** Automatic pipe nipple chuck for internal clamping of short pieces of pipe. In sturdy steel case.

Description	Art.-No.	€
<b>Set 1/2 + 3/4 + 1 + 1 1/4"</b>	111620R	<b>666,40</b>
<b>Set 1/2 + 3/4 + 1 + 1 1/4 + 1 1/2 + 2"</b>	111621R	<b>1.094,05</b>



German Quality Product



Accessories for threading machines with opening die head



German Quality Product



# REMS Spezial

Thread-cutting oil

High-alloyed mineral oil based thread-cutting oil.  
For all materials.

For drinking water supplies, comply with local regulations! Mineral oil based thread cutting materials are not permitted for drinking water pipes in AUT, CHE, DEU, DNK and FRA for example.

## REMS Spezial – high-alloyed mineral based thread-cutting oil, can be washed out with water. High lubricating and cooling effect.

Specially developed for threading. High lubricating and cooling effect. Essential for clean threads, long service life of dies, tools and machines.

Can be washed out with water, approved by experts.

Also well suited as a cooling lubricant for sawing metals.

REMS Spezial spray without CFC's, so ozone-harmless.

REMS Spezial squirt bottle without propellants. Refillable.



German Quality Product

### Supply format

REMS Spezial. High-alloyed mineral based thread-cutting oil.

Description	Packing	Art.-No.	€
REMS Spezial	5 l can	140100R	74,74
	10 l can	140101R	149,47
	50 l barrel	140103R	724,52
	600 ml spray	140105R	23,36
	500 ml squirt bottle	140106R	25,74

# REMS Sanitol

Thread-cutting oil

Synthetic, mineral oil-free thread-cutting oil.  
Specially for drinking water supplies. For all materials.

## REMS Sanitol – mineral oil-free, ethanol-free. Completely water soluble. High lubricating and cooling effect.

Developed especially for drinking water pipes but also excellently suitable for universal thread cutting. High lubricating and cooling effect. Essential for clean threads, long service life of dies, tools and machines.

Completely water soluble. Mineral oil-free, ethanol-free. Therefore no negative influence on the drinking water in terms of appearance, smell and taste.

Red in colour for flushing control. Perfect corrosion protector.

Viscosity at -10°C: ≤ 250 mPa s (cP). Pumpable to -28°C.

Also well suited as a cooling lubricant for sawing metals.

REMS Sanitol spray without CFC's, so ozone-harmless.

REMS Sanitol squirt bottle without propellants. Refillable.



German Quality Product

### Supply format

REMS Sanitol. Synthetic, mineral oil free thread-cutting oil specially for drinking water supplies and for universal use.

Description	Packing	Art.-No.	€
REMS Sanitol	5 l can	140110R	174,38
	50 l barrel	140113R	1.656,65
	600 ml spray	140115R	33,94
	500 ml squirt bottle	140116R	37,37



W1.303



7808-649

# REMS roll grooving attachment

Roll grooving attachment

Robust, compact roll grooving attachment with oil hydraulic forward feed for grooving pipes of pipe coupling systems. For installation, sprinkler lines, commercial heating, industry and mining. For job site and workshop.

Steel pipes DN 25 – 300  
1 – 12"  
s ≤ 7.2 mm

Stainless steel pipes, copper, aluminium, PVC pipes

**REMS roll grooving attachment – compact – universal. Oil hydraulic pressure cylinder for powerful in-feed of pressure roller.**

## Design

Compact, job site-proven. Robust metal housing for tough use. Handy, easy to transport, only 26 kg. Oil hydraulic pressure cylinder for powerful in-feed of pressure roller. Pressure build-up with hydraulic hand pump. Individually adjustable groove-depth-stop with fine adjustment, for automatic limitation of groove depth. Built-in ring gauge for automatic groove-depth-stop.

## Grooving rollers

The proven REMS grooving rollers with perfectly size-adjusted pressure rollers and counterpressure rollers with well gripping axial knurls guarantee a secure rotation of the pipe and precise grooving. Grooving rollers machined from hardened special steel ensure extremely long service life. 3 pairs of groove rollers (pressure roller, counter-pressure roller) for the whole working range DN 25 – 300, 1 – 12", easy change. Grooving rollers Cu (pressure roller, counterpressure roller) for copper pipe 54 – 159 mm. Groove rollers INOX (pressure roller made of stainless steel, counter-pressure roller made of toughened, specially hardened steel, nickel-plated) for stainless steel pipes 1 – 1½", 2 – 6" and 8 – 12". Grooving rollers for aluminium, PVC pipes on request.

## Drive

Only one roll grooving device for REMS Amigo, REMS Amigo 2, REMS Amigo 2 Compact, REMS Tornado and REMS Magnum. Fast, simple assembly. 3-face drive shaft of roll grooving attachment for secure clamping and optimum power transmission. Roll grooving attachments for threading machines of other makes, adjusted to support arm distance, diameter of support arm and spindle axis of the corresponding drive machine, on request.



German Quality Product



Info



## Supply format

**REMS roll grooving attachment.** Roll grooving attachment for grooving pipes of pipe coupling systems DN 25 – 300, 1 – 12". Roll grooving attachment, hydraulic hand pump, built-in ring gauge for automatic groove-depth-stop, 1 pair of groove rollers (pressure roller, counter-pressure roller) 2 – 6", Allen key. For REMS Amigo, REMS Amigo 2, REMS Amigo 2 Compact, REMS Tornado and REMS Magnum or for other thread cutting machine makes. In a carton.

Description	fit onto	Art.-No.	€
<b>REMS roll grooving attachment</b>	REMS Amigo/ Amigo 2 Compact <sup>1)</sup> REMS Amigo 2 <sup>1)</sup> REMS Tornado <sup>2)</sup> REMS Magnum <sup>2)</sup>	347000R	<b>2.242,08</b>
<b>Roll grooving attachment R 300</b>	Ridgid 300	347001R	<b>2.242,08</b>

<sup>1)</sup> Conversion kit Amigo/Amigo 2/Amigo 2 Compact (Art. No. 347007) required.

Can be used for roll grooving devices manufactured from 2014 onwards.

<sup>2)</sup> Can only be used for roll grooving up to DN 200, 8" on T versions.

Roll grooving attachments for other makes on request.

## Accessories

Description	Art.-No.	€
<b>Grooving rollers 1 – 1½" (pair), for steel pipes</b>	347030	<b>310,36</b>
<b>Grooving rollers INOX 1 – 1½" (pair), for stainless steel pipes</b>	347053	<b>747,36</b>
<b>Grooving rollers 2 – 6" (pair), for steel pipes</b>	347035	<b>310,36</b>
<b>Grooving rollers INOX 2 – 6" (pair), for stainless steel pipes</b>	347046	<b>840,78</b>
<b>Grooving rollers 8 – 12" (set), for steel pipes</b>	347040	<b>507,58</b>
<b>Grooving rollers INOX 8 – 12" (pair), for stainless steel pipes</b>	347047	<b>851,16</b>
<b>Grooving rollers Cu 54 – 159 (pair) for Cu pipes</b>	347034	<b>310,36</b>
<b>Conversion kit Amigo / Amigo 2 / Amigo 2 Compact / Amigo 22V</b>	347007R	<b>153,62</b>

REMS Herkules material supports, see page 107.





Powerful roll grooving machine for fast, economical grooving of pipes for pipe coupling systems. For installation, sprinkler lines, commercial heating, industry and mining. For job site and workshop.

Steel pipes DN 25 – 300  
1 – 12"  
s ≤ 7.2 mm

Stainless steel pipes, copper, aluminium, PVC pipes

**REMS Collum – electrical roll grooving up to 12".**  
**Fast and economical feed of the pressure roller with oil-hydraulic pressure cylinder.**

### Design

Robust, compact construction suitable for building sites. Favourable dimensions, favourable weight, roll grooving device with drive machine only 31 kg. For work bench. Stand or wheel stand as an accessory, for easy transport, optimum working height and stable positioning.

### Drive

Fast and powerful, e.g. roll grooving of 6" steel pipe with REMS Collum in just 52 s. Sturdy, compact gear, maintenance-free. Robust, powerful 1200 W universal motor (REMS Collum and REMS Collum 2 Compact) or 1700 W universal motor (REMS Collum 2) for intensive use at large dimensions. Safety switch. Foot switch with coupling for ergonomic working as an accessory.

### Roll grooving attachment

Compact, job site-proven. Robust metal housing for tough use. Handy, easy to transport, only 26 kg. Oil hydraulic pressure cylinder for powerful in-feed of pressure roller. Pressure build-up with hydraulic hand pump. Built-in ring gauge for automatic groove-depth-stop.

### Grooving rollers

The proven REMS grooving rollers with perfectly size-adjusted pressure rollers and counterpressure rollers with well gripping axial knurls guarantee a secure rotation of the pipe and precise grooving. Grooving rollers machined from hardened special steel ensure extremely long service life. 3 pairs of groove rollers (pressure roller, counter-pressure roller) for the whole working range DN 25 – 300, 1 – 12", easy change. Grooving rollers Cu (pressure roller, counterpressure roller) for copper pipe 54 – 159 mm. Groove rollers INOX (pressure roller made of stainless steel, counter-pressure roller made of toughened, specially hardened steel, nickel-plated) for stainless steel pipes 1 – 1½", 2 – 6" and 8 – 12". Grooving rollers for aluminium, PVC pipes on request.

### Material support

Extra sturdy REMS Herkules XL 12" material support for roll grooving of pipes up to 12" (page 107).



German Quality Product



Info

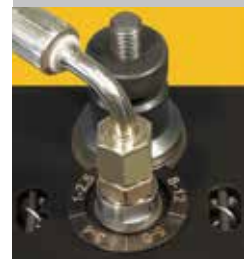

Wheel stand (Accessory)

Herkules 3B (Accessory)

### Supply format

**REMS Collum.** Roll grooving attachment for grooving pipes of pipe coupling systems DN 25 – 300, 1 – 12". Roll grooving attachment, hydraulic hand pump, built-in ring gauge for automatic groove-depth-stop, 1 pair of groove rollers (pressure roller, counter-pressure roller) 2 – 6", Allen key. Choice of 3 drive units, with maintenance-free gear, powerful universal motor, safety switch. For workbench, stand or wheel stand. In a carton.

Description	Version	Art.-No.	€
<b>Collum</b>	Universal motor 230 V, 50 – 60 Hz, 1200 W, overload protection. 29 min <sup>-1</sup>	347006R220	<b>2.761,08</b>
<b>Collum 2</b>	Universal motor 230 V, 50 – 60 Hz, 1700 W. 28 min <sup>-1</sup>	347008R220	<b>3.093,24</b>
<b>Collum 2 Compact</b>	Universal motor 230 V, 50 – 60 Hz, 1200 W, overload protection. 26 min <sup>-1</sup>	347009R220	<b>3.093,24</b>

Other voltages on request.

### Accessories

Description	Art.-No.	€
<b>Stand</b>	849315R	<b>216,94</b>
<b>Wheel stand</b>	849310R	<b>351,88</b>
<b>Foot switch with coupling</b>	347010R220	<b>249,12</b>

**REMS Herkules** material supports, see page 107.

**Grooving rollers** and other accessories, see page 48.



Powerful, mobile, cordless roll grooving machine for fast, economical grooving of pipes for pipe coupling systems. For installation, sprinkler lines, commercial heating, industry and mining. For job site and workshop. Li-Ion 22V Technology. For battery and corded operation.

Steel pipes	DN 25 – 300 1 – 12" s ≤ 7.2 mm
-------------	--------------------------------------

Stainless steel pipes, copper, aluminium, PVC pipes

**REMS Collum 22 V – electrical roll grooving up to 12".**  
**Mobile, fast, economical. Feed of the pressure roller with oil-hydraulic pressure cylinder. Li-Ion 21.6 V, 9.0 Ah battery, for approx. 23 DN 100/4" grooves with one battery charge\*.**

### Design

Compact, robust, building site-compatible, mobile. Convenient dimensions, comfortable weight, cordless roll grooving machine with drive unit just 34 kg. Practical D-shaped handle with soft grip. Machine status check with overload protection of the drive unit against too high currents, with overheating protection by motor temperature monitoring (NTC), with electronic battery charging status check by a 2-coloured green/red LED. For work bench. Stand or wheel stand as an accessory, for easy transport, optimum working height and stable positioning.

### Drive

Powerful and fast, e.g. roll grooving of 4" steel pipe in just 77 s. Solid, maintenance-free gear. Powerful battery motor 21.6 V, with high power reserve, 500 W output, for intensive use with large dimensions. High grooving speed 27 – 20 rpm. Safety tip switch.

### Battery or mains operation

Li-Ion 22V Technology. Highly resistant Li-Ion 21.6 V batteries with 9.0 Ah capacity for long service life. Light and powerful, for approx. 23 DN 100/4" grooves with one battery charge\*. Graduated charging status check by coloured LEDs. Operating temperature range –10 to +60 °C. No memory effect for maximum battery power. Rapid charger 100 – 240 V, 90 W. Rapid charger 100 – 240 V, 290 W, for shorter charging times, as accessory. Voltage supply 220 – 240 V/21.6 V, 40 A output, for mains operation instead of Li-Ion battery 21.6 V, as accessory.

### Roll grooving attachment

Compact, job site-proven. Robust metal housing for tough use. Handy, easy to transport, only 26 kg. Oil hydraulic pressure cylinder for powerful in-feed of pressure roller. Pressure build-up with hydraulic hand pump. Built-in ring gauge for automatic groove-depth-stop.

### Grooving rollers

The proven REMS grooving rollers with perfectly size-adjusted pressure rollers and counterpressure rollers with well gripping axial knurls guarantee a secure rotation of the pipe and precise grooving. Grooving rollers machined from hardened special steel ensure extremely long service life. 3 pairs of groove rollers (pressure roller, counter-pressure roller) for the whole working range DN 25 – 300, 1 – 12", easy change. Grooving rollers Cu (pressure roller, counterpressure roller) for copper pipe 54 – 159 mm. Groove rollers INOX (pressure roller made of stainless steel, counter-pressure roller made of toughened, specially hardened steel, nickel-plated) for stainless steel pipes 1 – 1½", 2 – 6" and 8 – 12". Grooving rollers for aluminium, PVC pipes on request.

### Material support

Extra sturdy REMS Herkules XL 12" material support for roll grooving of pipes up to 12" (page 107).



German Quality Product



Info





Wheel stand (Accessory)

Herkules 3B (Accessory)



Stand (Accessory)

Herkules XL 12" (Accessory)



### Supply format

**REMS Collum 22V.** Cordless roll grooving machine for grooving pipes for DN 25–300, 1–12" pipe coupling systems. Roll grooving attachment, hydraulic hand pump, built-in ring gauge for automatic groove-depth-stop, 1 pair of groove rollers (pressure roller, counter-pressure roller) 2–6", Allen key. Drive unit with maintenance-free gear, powerful battery motor 21.6V, 500 W. Safety switch. Right and left-hand rotation, machine status check with overload protection, temperature monitoring, battery charging status check. Universal support. Li-Ion 21.6V, 9.0Ah battery, 100–240V, 50–60 Hz, 90W rapid charger. For workbench, stand or wheel stand. In a carton.

	Art.-No.	€
	347005R220	3.736,80

Other voltages on request.

### Accessories

Description	Art.-No.	€
<b>REMS Amigo 22V drive unit, without battery</b>	530004R22	1.162,56
<b>Battery Li-Ion 21.6V, 9.0 Ah</b>	571583R22	414,16
<b>Rapid charger 100–240V, 50–60 Hz, 90W</b>	571585R220	175,42
<b>Rapid charger 100–240V, 50–60 Hz, 290W</b>	571587R220	414,16
<b>Voltage supply 220–240V/21.6V, 50–60 Hz, 40 A, for mains operation instead of battery Li-Ion 21.6V</b>	571578R220	517,96
<b>Stand</b>	849315R	216,94
<b>Wheel stand</b>	849310R	351,88

**REMS Herkules** material supports, see page 107.

**Grooving rollers** and other accessories, see page 48.

**REMS Lumen 2800 22V**, cordless LED flood light, see page 111



Robust, compact high performance machine with roll grooving attachment for pipe grooving of pipe coupling systems. For installation, sprinkler lines, commercial heating lines, industry and mining.  
For job site and workshop.

Steel pipes	DN 25 – 300 1 – 12" s ≤ 7.2 mm
-------------	--------------------------------------

Stainless steel pipes, copper, aluminium, PVC pipes

Pipe threads 1/8" – 2", 16 – 63 mm, bolt threads 6 – 60 mm, 1/4" – 2", with conversion kit.

**REMS Magnum RG – the compact up to 12". Immensely powerful and extremely fast. Feed of the pressure roller with oil-hydraulic pressure cylinder.**

### Design

Robust, compact, job site-proven design. Favorable size and weight, e.g. REMS Magnum 2000 RG-T only 68 kg. Tool support. For workbench. Stand, collapsible wheel stand or wheel stand with material shelf, as an accessory, for easy transport, optimum working height and stable positioning.

### Drive

Immensely powerful and fast, e.g. roll grooving of 6" steel pipe with REMS Magnum 2010 RG-T in just 40 s. Completely maintenance-free gear which runs in a sealed oil bath. Choice of 3 powerful motors (see REMS Magnum page 34). Operator-friendly safety foot switch with emergency-stop, 2-step, can be loaded with the full body weight during operation.

### Roll grooving attachment

Compact, job site-proven. Robust metal housing for tough use. Handy, easy to transport, only 26 kg. Oil hydraulic pressure cylinder for powerful in-feed of pressure roller. Pressure build-up with hydraulic hand pump. Built-in ring gauge for automatic groove-depth-stop.

### Grooving rollers

The proven REMS grooving rollers with perfectly size-adjusted pressure rollers and counterpressure rollers with well gripping axial knurls guarantee a secure rotation of the pipe and precise grooving. Grooving rollers machined from hardened special steel ensure extremely long service life. 3 pairs of groove rollers (pressure roller, counter-pressure roller) for the whole working range DN 25–300, 1–12", easy change. Grooving rollers Cu (pressure roller, counterpressure roller) for copper pipe 54–159 mm. Groove rollers INOX (pressure roller made of stainless steel, counter-pressure roller made of toughened, specially hardened steel, nickel-plated) for stainless steel pipes 1–1½", 2–6" and 8–12". Grooving rollers for aluminium, PVC pipes on request.

### Conversion kit for threading

Tool set 1/4"–2" complete with universal automatic die head, dies for pipe threads, tapered, ISO 7-1 (DIN 2999, BSPT) R 1/2"–3/4" and R 1–2" right-hand, pipe cutter, inner pipe deburrer, pressing lever, pump for automatic oiling, oil basin, chip tray.

### Material support

Extra sturdy REMS Herkules XL 12" material support for roll grooving of pipes up to 12" (page 107).



German Quality Product



Info



Stand (Accessory)



Wheel stand (Accessory)

Herkules 3B (Accessory)

### Supply format

**REMS Magnum RG.** Roll grooving machine for pipe grooving of pipe coupling systems DN 25–300, 1–12". With maintenance-free gear, safety foot switch with emergency-stop, self-tightening quick-action hammer chuck, rear centering device, automatic lubrication and cooling, tool support. Choice of 3 motors. Roll grooving attachment, hydraulic hand pump, built-in ring gauge with automatic groove-depth-stop, 1 set of grooving rollers (pressure roller, counterpressure roller) 2–6", hexagon key. For workbench, stand, collapsible wheel stand or wheel stand with material shelf. In a carton.

Description	Version	Art.-No.	€
<b>2000 RG-T</b>	Universal motor 230 V or 110 V, 50–60 Hz, 1700 W. 53 rpm.	340230R220	<b>5.646,72</b>
<b>2010 RG-T</b>	Pole-reversible capacitor motor 230 V, 50 Hz, 2100 W. 52/26 rpm, also under full load. Extremely quiet running.	340231R220	<b>5.999,64</b>
<b>2020 RG-T</b>	Pole-reversible 3~ induction motor 400 V, 50 Hz, 2000 W. 52/26 rpm, also under full load. Extremely quiet running.	340232R380	<b>6.279,90</b>

Other voltages on request.

### Accessories

Description	Art.-No.	€
<b>Stand</b>	344105R	<b>290,64</b>
<b>Wheel stand with material support</b>	344100R	<b>493,05</b>
<b>Collapsible wheel stand</b>	344150R	<b>705,84</b>
<b>REMS Herkules material supports, see page 107.</b>		
<b>Grooving rollers and other accessories, see page 48.</b>		
<b>Conversion kit Magnum RG-T to L-T for threading.</b>	340110RR	<b>1.453,20</b>











Collapsible wheel stand (Accessory)





# Sawing

	<b>Universal electric reciprocating saws</b>	<b>58</b>
	<b>Cordless universal reciprocating saw</b>	<b>60</b>
	<b>Electric reciprocating pipe saws</b>	<b>62</b>
	<b>Pneumatic reciprocating pipe saw</b>	<b>64</b>
	<b>Cordless pipe reciprocating saw</b>	<b>66</b>
	<b>Saw blades for reciprocating saws</b>	<b>68</b>
	<b>Circular pipe sawing machine</b>	<b>70</b>
	<b>Universal circular metal sawing machine</b>	<b>71</b>



**Aggressive orbital action** by vertical hacking motion of saw blade provides forceful, fast forward feed, excellent chip flow and long service life of saw blades.

**Fixed orbital action, running in needle bearings**, ensures long-lasting and forceful sawing also during extreme load conditions, e.g. sawing of steel pipe. Adjustable mechanisms with a great variety of parts and a reduced system stability do not withstand the high in-feed pressure and the heavy-duty requirements of forceful cutting of steel pipes, particularly when a guide support with leverage is being used.



Sturdy, square lift rod in special solid steel, mounted precisely in needle bearings towards the force direction and along the complete stroke length, for distortion-free, precise cutting also during tough use and by applying multiple sawing force, e.g. using a guide support with leverage. For extremely long service life.

Special high sliding silicone gasket protects gear against water and dust.



**ANC**

Super stable, water and dust resistant, maintenance-free oscillating gear enables a simultaneous generation of saw and orbital stroke of lift rod and saw blade. Allround needle bearing mounted crank drive (ANC) reduces friction, heat generation, wear. Thus long service life also at extreme sawing.

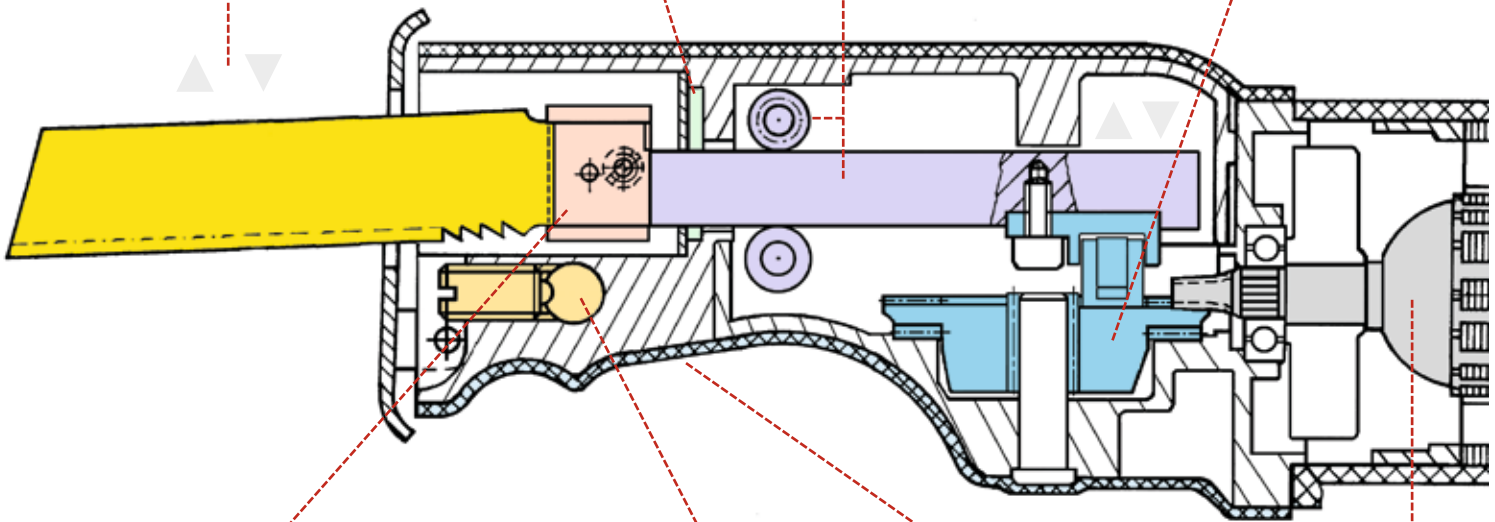

Universal saw blade clamp for mounting all saw blades – with universal or double tang – without changing or turning the saw blade thrust piece.



Guide support for 400 % additional sawing force for fast, effortless sawing. Also for effortless demolition work.

V/bar  
Drive motors  
230 V, 110 V, 48 V,  
22 V, 6 bar

Ergonomically shaped front housing grip with slip resistant protection cover, for forceful feed forward while sawing free-hand.





### Vario-Electronic

Electronic stepless speed control of drive unit for sensitive start-sawing and for stroke selection during sawing according to the material. The stroke speed is controlled continuously by variable pressure on the touch switch from 0 to 2,800 rpm (REMS Puma VE), 0 to 2,400 rpm (REMS Cat VE, REMS Tiger VE) or 0 to 1,900 rpm (REMS Cat 22V VE, REMS Tiger 22V VE) (accelerator switch).



### Ideal speed

Deliberately fixed speed. Therefore optimum cutting speed for maximum protection of motor and gear and maximum service life of saw blades. The ideal cutting speed of 2,400 rpm has been determined by extensive sawing tests with steel pipe which lead to optimum performance in combination with the aggressive, fixed orbital action, guide support and REMS special saw blade.



### Power-transferring guide support

400% more sawing power for effortless, ultra-fast sawing of pipes and profiles, e.g., 2" steel pipe in just 8 s. For assembly and disassembly. Guide support with 5-fold power-transferring leverage allows effortless, fast, right-angled sawing everywhere on site, also free-hand without a pipe vice. Ideal handling, very quick and easy operation, only one handle for clamping and sawing. No free-swinging chain. No danger of jamming by limitation of swing angle. Straight machine handle for optimum forward feed.



### Power-transferring chain guide support 6"

400% more sawing power for effortless, ultra-fast sawing of  $\varnothing \frac{1}{8}$ –6" pipes and other profiles, e.g., 2" steel pipe in just 8 s. For assembly and disassembly. Guide support with 5-fold power-transferring leverage allows effortless, fast, right-angled sawing everywhere on site, even in very confined spaces. Clamping chain with strong chain links, easy clamping by quick closure and threaded spindle. Straight machine handle for optimum forward feed.



### Speed-Regulation

Stepless electronic speed control of drive unit for selecting the speed according to the material. Ideal for sawing stainless steel pipe, cast pipe and for sawing boilers, tanks, bath tubs etc. The speed is continuously adjustable between 700 and 2,200 rpm on the dial. The electronic speed control which is being used keeps the selected speed constant, also under load, including speed generator, control electronics, residual current limitation for sensitive start-sawing, motor temperature control of field wires with PTC resistance (Positive Temperature Coefficient) and stall protection of gear and motor.



### Weight

High sawing efficiency at low weight by innovative, proven technology and perfect tuning of all components. For effortless, fatigue-free sawing and easy handling.



### Power

All power data stated to be understood as the rated power input. The drive motors of REMS reciprocating saws have a very high efficiency of approx. 65% thanks to an outstanding technology and quality. Therefore the user has a high power output available which is useful particularly for sawing difficult-to-cut materials, e.g. steel pipe. High power output can only be used fully by levered sawing, e.g. with the REMS guide support.



### Drive Motors

Depending on model universal motors of voltages of 230 V, 110 V, 48 V, battery motors 22 V or pneumatic motors for 6 bar operating pressures are used. All drive motors are extremely powerful, fulfill highest quality demands and come with large power reserves, for long service life.



### Saw blade holder with quick-change system

Practical saw blade holder with quick-change system for fast saw blade changing without tools. For holding single tang saw blades.



### Continuously adjustable support shoe

Swivel support shoe for safe guiding of the saw on the material to be sawn. Support shoe continuously adjustable in longitudinal direction by 40 mm for better utilisation of partially blunted saw blades and for setting the plunge-in depth of the saw blade in the material.



### Anti-vibration system

Special drive technology with mass compensation and vibration damping handles. For low vibration, effortless sawing.



### Saw blade can be inserted turned 180°

Saw blade can be inserted with the teeth facing down or turned 180° facing up for cuts in confined spaces with difficult access.

Powerful power tool for universal free-hand sawing. Only 3.8 kg. Ideal for assembly, disassembly, repair.

Many materials, e.g. wood, wood with nails, pallets, metal, even stainless steel, cast iron, breeze blocks, plaster boards, pumice stone, brick

**REMS Puma VE – the powerful universal saw with anti-vibration system. Quick saw blade change without tools. Adjustable support shoe.**

### Universal use

Can be used anywhere, free hand, over head, in tight corners, flush with the wall. Extremely versatile and powerful. For all sawing work on the building site and for rescue and emergency operations. Also for plunge-cut sawing.

### Design

Powerful, suitable for building sites. Handy, easy grip shape. Only 3.8 kg. Ergonomically designed front housing grip with non-slip, heat insulating protective jacket with soft grip, for powerful sawing thrust. Practical D-shaped handle with vibration damping soft grip. Drive rod runs in an enclosed drive housing for safe work. Large saw blade stroke, 30 mm, for better cut clearance. Fast stroke speed up to 2,800 rpm for fast sawing thrust and effective sawing. Robust crank drive, maintenance-free. High sliding special seal. Powerful, high capacity universal motor with large power reserve, 1,300 W, safety switch. 4 m long connecting lead. Safety switch.

### Anti-vibration system

Special drive technology with mass compensation and vibration damping handles. For low vibration, effortless sawing.

### Vario-Electronic

Continuous electronic stroke speed control for gentle start of sawing and selection of a stroke speed suitable for the material. The stroke speed can be continuously controlled by variable pressure on the safety switch from 0 to 2,800 rpm (accelerator switch).

### Saw blade holder with quick-change system

Practical saw blade holder with quick-change system for fast saw blade changing without tools. For holding single tang saw blades. Saw blade can be inserted with the teeth facing down or turned 180° facing up for cuts in confined spaces with difficult access.

### REMS saw blades

Full range of REMS saw blades for free-hand sawing of different materials (page 69).

### Continuously adjustable support shoe

Swivel support shoe for safe guiding of the saw on the material to be sawn. Support shoe continuously adjustable in longitudinal direction by 40 mm for better utilisation of partially blunted saw blades and for setting the plunge-in depth of the saw blade in the material. For economical working.

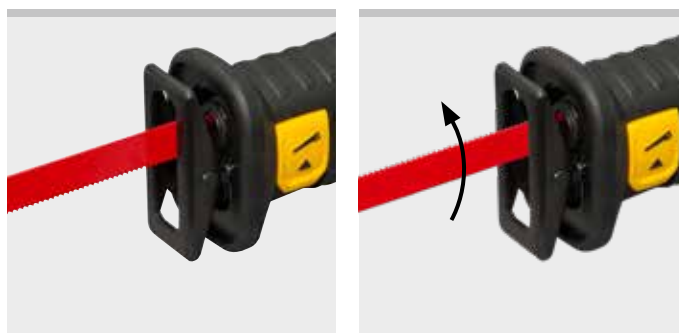

Info

### Supply format

**REMS Puma VE Set.** Electric universal reciprocating saw with Vario-Electronic (VE) for free-hand sawing, with anti-vibration system. Drive machine with D-shaped handle with soft grip, maintenance-free crank drive, powerful 230 V, 50–60 Hz, 1,300 W universal motor, safety switch, connecting cable 4 m. Continuous electronic stroke speed control (accelerator switch) 0 to 2,800 rpm. 30 mm stroke. Saw blade holder with quick-change system Adjustable support shoe. Hexagon key. 1 REMS saw blade 210-1.8/2.5. In sturdy steel case.

	Art.-No.	€
	560023R220	<b>369,53</b>

Other voltages on request.

### Accessories

Description	Art.-No.	€
<b>REMS Puma VE drive unit</b>	560003R220	<b>331,12</b>
<b>REMS saw blades</b> see page 69.		
<b>Steel case</b>	566051R	<b>82,73</b>



REMS



# REMS Cat VE

Universal electric reciprocating saw

Powerful, robust, handy power tool for universal free-hand sawing. Only 3.0 kg. Ideal for assembly, dismantling, repair.

Many materials, e.g. wood, wood with nails, pallets, metal, even stainless steel, cast iron, breeze blocks, plaster boards, pumice stone, brick

Especially also for steel pipes

## REMS Cat VE – saws anything, anywhere.

**Extremely versatile and powerful.**

**Robust and handy.**

### Universal use

Ready for use anywhere, free-hand, overhead, in confined areas, flush to wall. Extremely versatile and efficient. Especially also for sawing metal pipes, sawing up boilers, tanks, bath tubs. For rescue and emergency operations. Also for plunge-cut sawing.

### Design

Robust, job site-proven. Slender, handy design. Super light, only 3.0 kg. Ergonomically shaped front housing grip with slip resistant, heat insulating protection cover with soft grip, for forceful feed forward. Proven D-shaped handle. Swivel support shoe for safe guiding of the saw on the material to be sawn. High sliding silicone gasket protects gear against water and dust. Powerful universal motor with ample reserve capacity, 1050 W. Safety tip switch.

### Sturdy, square lift rod

In special solid steel, mounted precisely in needle bearings towards the force direction and along the complete stroke length, for distortion-free, precise cutting also during tough use. For extremely long service life. Drive rod runs in an enclosed housing for safe work.

### Oscillating drive with ANC

Super stable, water and dust resistant, maintenance-free oscillating drive for simultaneous generation of sawing stroke and orbital action of lift rod and saw blade. Allround needle bearing mounted crank drive (ANC) reduces friction, heat generation, wear. For long service life of drive also at extreme sawing.

### Aggressive orbital action

Aggressive orbital action by vertical hacking motion of saw blade provides forceful, fast forward feed, excellent chip flow and long service life of saw blades. Fixed orbital action, running in needle bearings, ensures long-lasting and forceful sawing also during extreme load conditions, e.g. sawing of steel pipe.

### Vario-Electronic

Electronic stepless speed control of drive unit for sensitive start sawing and for speed selection during sawing. The speed is controlled by pressing the tip switch steplessly from 0 to 2,400 rpm (acceleration switch).

### Universal saw blade clamp

All saw blades – with universal or double tang – can be clamped without changing or turning the saw blade thrust piece.

### REMS universal saw blade

Only 1 REMS universal saw blade (page 68) for all sawing work instead of many different saw blades. Double tang for free-hand sawing and sawing with guide holder.

### REMS saw blades

Full range of REMS saw blades for free-hand sawing of different materials (page 69).



# ANC

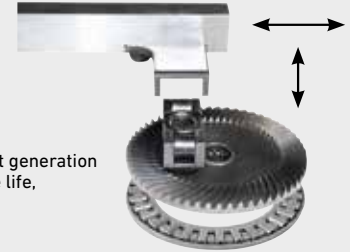

- reduced friction and wear
- substantially reduced heat generation
- for extremely long service life, also during tough use



German Quality Product



Info



## Supply format

**REMS Cat VE Set.** Electric universal reciprocating saw with Vario-Electronic (VE) for free-hand sawing. Drive unit with D-shaped handle, maintenance-free, water and dust resistant oscillating drive with allround needle bearing mounted crank drive (ANC), aggressive orbital action, powerful universal motor 230 V or 110 V, 50–60 Hz, 1050 W, safety tip switch. Electronic stepless speed control (acceleration switch) 0 to 2,400 rpm. Universal saw blade clamp. Hexagon key. 1 REMS universal saw blade 150-1.8/2.5. In sturdy steel case.

	Art.-No.	€
	560040R220	580,24

Other voltages on request.

## Accessories

Description	Art.-No.	€
<b>REMS Cat VE drive unit</b>	560004R220	580,24
<b>REMS saw blades</b> see page 68–69.		
<b>Steel case</b>	566005R	82,73



# REMS Cat 22V VE

Cordless universal reciprocating saw

Powerful, mobile, handy power tool for universal free-hand sawing. Only 3.1 kg. Ideal for assembly, dismantling, repair. Li-Ion 22V Technology. For battery and corded operation.

Many materials, e.g. wood, wood with nails, pallets, metal, even stainless steel, cast iron, breeze blocks, plaster boards, pumice stone, brick

Especially also for steel pipes

**REMS Cat 22V VE – saws anything, anywhere. Mobile, handy, light. Li-Ion 21.6V, 5.0 Ah battery, for approx. 75 1" steel pipe cuts with one battery charge\*.**

## Universal use

Ready for use anywhere, free-hand, overhead, in confined areas, flush to wall. Mains independent. Extremely versatile and efficient, particularly for metal. Saws metal pipes, boilers, tanks, bath tubs, window frames, etc., for rescue and disaster service operations. Also for plunge-cut sawing.

## Design

Robust, job site-proven. Mobile, handy, light. Drive unit with battery pack weighs only 3.1 kg. Slim form. Ergonomically shaped front housing grip with slip resistant, heat insulating protection cover with soft grip, for forceful feed forward. Practical D-shaped handle with soft grip. Swivel support shoe for safe guiding of the saw on the material to be sawn. High sliding silicone gasket protects gear against water and dust. Powerful 21.6 V battery motor with ample reserve capacity, 500 W output. Safety tip switch. Machine status check with overload protection of the drive unit against too high currents, with overheating protection by motor temperature monitoring (NTC), with electronic battery charging status check with charging level indication by a 2-coloured green/red LED.

## Sturdy, square lift rod

In special solid steel, mounted precisely in needle bearings towards the force direction and along the complete stroke length, for distortion-free, precise cutting also during tough use. For extremely long service life.

## Oscillating drive with ANC

Super stable, water and dust resistant, maintenance-free oscillating drive for simultaneous generation of sawing stroke and orbital action of lift rod and saw blade. Allround needle bearing mounted crank drive (ANC) reduces friction, heat generation, wear. For long service life of drive also at extreme sawing.

## Vario-Electronic

Electronic stepless speed control of drive unit for sensitive start sawing and for speed selection during sawing. The speed is controlled by pressing the tip switch steplessly from 0 to 1,900 rpm (acceleration switch).

## Aggressive orbital action

Aggressive orbital action by vertical hacking motion of saw blade provides forceful, fast forward feed, excellent chip flow and long service life of saw blades. Fixed orbital action, running in needle bearings, ensures long-lasting and forceful sawing also during extreme load conditions, e.g. sawing of steel pipe.

## Battery or mains operation

Li-Ion 22V Technology. Highly resistant Li-Ion 21.6V battery with 4.4, 5.0 or 9.0 Ah capacity, for long service life. Light and powerful. Li-Ion 21.6V, 4.4 Ah battery, for approx. 66 1" steel pipe cuts, 5.0 Ah battery, for approx. 75 1" steel pipe cuts, 9.0 Ah for approx. 140 1" steel pipe cuts with one battery charge\*. Graduated charging status check by coloured LEDs. Operating temperature range – 10 to + 60 °C. No memory effect for maximum battery power. Rapid charger 100–240V, 90W. Rapid charger 100–240V, 290W, for shorter charging times, as accessory. Voltage supply 220–240V/21.6V, 40 A output, for mains operation instead of Li-Ion battery 21.6 V, as accessory.

## Universal saw blade clamp

All saw blades – with universal or double tang – can be clamped without changing or turning the saw blade thrust piece.

## REMS universal saw blade

Only 1 REMS universal saw blade (page 68) for all sawing work instead of many different saw blades. Double tang for free-hand sawing and sawing with guide holder.

## REMS saw blades

Full range of REMS saw blades for free-hand sawing of different materials (page 69).



German Quality Product



## Supply format

**REMS Cat 22V VE Set.** Battery driven universal reciprocating saw with Vario-Electronic (VE) for free-hand sawing. Drive unit with D-shaped handle, maintenance-free, water and dust resistant oscillating drive with allround needle bearing mounted crank drive (ANC), aggressive orbital action, powerful 21.6 V battery motor, safety tip switch. Electronic stepless speed control (acceleration switch) 0 to 1,900 rpm. Machine status check with overload protection, temperature monitoring, battery charging status check. Li-Ion 21.6V, 5.0Ah battery, 100–240V, 50–60 Hz, 90W rapid charger. Universal saw blade clamp. Hexagon key. 1 pcs REMS universal saw blade 150-1.8/2.5. In sturdy steel case.

	Art.-No.	€
	560052R220	<b>1.230,03</b>

Other voltages on request.



## Accessories

Description	Art.-No.	€
<b>REMS saw blades</b> see page 68 – 69.		
<b>REMS Cat 22V VE drive unit,</b> without battery	560010R22	<b>704,80</b>
<b>Battery Li-Ion 21.6V, 4.4 Ah</b>	571574R22	<b>372,64</b>
<b>Battery Li-Ion 21.6V, 5.0 Ah</b>	571581R22	<b>310,36</b>
<b>Battery Li-Ion 21.6V, 9.0 Ah</b>	571583R22	<b>414,16</b>
<b>Rapid charger 100–240V, 50–60 Hz, 90W</b>	571585R220	<b>175,42</b>
<b>Rapid charger 100–240V, 50–60 Hz, 290W</b>	571587R220	<b>414,16</b>
<b>Voltage supply 220–240V/21.6V, 50–60 Hz, 40 A,</b> for mains operation instead of battery Li-Ion 21.6V	571578R220	<b>517,96</b>
<b>Steel case</b> with inlay	566030R	<b>128,71</b>
<b>REMS Lumen 2800 22V,</b> cordless LED flood light, see page 111		



Powerful, robust, handy power tool with force-transmitting guide holder for effortless, fast, right-angled sawing everywhere on site, without a vice. Also for universal free-hand sawing. Only 3.0 kg. Ideal for assembly, dismantling, repair.

Ideal for steel pipes and others.

Many materials, e.g. wood, wood with nails, pallets, metal, even stainless steel, cast iron, breeze blocks, plaster boards, pumice stone, brick

For materials that are difficult to cut, e.g. stainless steel pipes, hard cast iron, use the REMS Tiger SR with electronic stroke speed control.

## REMS Tiger – the saw for the pipe fitter.

**Saws effortless, fast, right angle.**

**Robust and handy.**

### Power-transferring guide support

400 % more sawing power for effortless, ultra-fast sawing of pipes and profiles, e.g., 2" steel pipe in just 8 s. For assembly and disassembly. Guide support with 5-fold power-transferring leverage allows effortless, fast, right-angled sawing everywhere on site, also free-hand without a pipe vice. Ideal handling, very quick and easy operation, only one handle for clamping and sawing. No free-swinging chain. No danger of jamming by limitation of swing angle. For optimum in-feed with guide support a straight machine handle is advantageous.

### Power-transferring chain guide support 6"

400 % more sawing power for effortless, ultra-fast sawing of  $\varnothing \frac{1}{8}$ –6" pipes and other profiles, e.g., 2" steel pipe in just 8 s. For assembly and disassembly. Guide support with 5-fold power-transferring leverage allows effortless, fast, right-angled sawing everywhere on site, even in very confined spaces. Clamping chain with strong chain links, easy clamping by quick closure and threaded spindle. For optimum in-feed with guide support a straight machine handle is advantageous.

### Right angle sawing

Right angle cut thanks to REMS guide support and REMS special saw blade. Essential for subsequent operations in pipe installation.

### REMS special saw blade

REMS special saw blade (page 68), extra thick, rigid and unbendable, double tang, absolutely essential for right-angled sawing and fast disassembly of steel pipes with force-transmitting guide holder.

### REMS universal saw blade

Only 1 REMS universal saw blade (page 68) for all sawing work instead of many different saw blades. Double tang for free-hand sawing and sawing with guide holder.

### REMS saw blades

Full range of REMS saw blades for free-hand sawing of different materials (page 69).

### Universal saw blade clamp

All saw blades – with universal or double tang – can be clamped without changing or turning the saw blade thrust piece.

### Design

Robust, job site-proven. Slender, handy design. Super light, only 3.0 kg. Can be used anywhere. Ergonomically shaped front housing grip with slip resistant protection cover for forceful feed forward during free-hand sawing. Choice of practical D-shaped handle, advantageous during free-hand sawing, or straight machine handle, advantageous during sawing with guide support. Swivel support shoe for safe guiding of the saw on the material to be sawn. High sliding silicone gasket protects gear against water and dust. Powerful universal motor with ample reserve capacity, 1050 W respectively 1400 W (REMS Tiger SR). Safety tip switch. Choice of drive unit with fixed, ideal speed, electronic speed control (Vario-Electronic) or electronic speed regulation. Overload protection (REMS Tiger) protects motor, gear and saw blade. The electronic tachometer speed controller (REMS Tiger SR) used for control keeps the preselected number of strokes constant even under load and includes tachogenerator, electronic control, start-up current limiter for soft start-up, overheating protection by temperature monitoring of the field winding of the motor with PTC resistance (Positive Temperature Coefficient) and blocking protection for gearbox and motor.

### Sturdy, square lift rod

In special solid steel, mounted precisely in needle bearings towards the force direction and along the complete stroke length, for distortion-free, precise cutting also during tough use. For extremely long service life. Drive rod runs in an enclosed housing for safe work.

### Oscillating drive with ANC

Super stable, water and dust resistant, maintenance-free oscillating drive for simultaneous generation of sawing stroke and orbital action of lift rod and saw blade. Allround needle bearing mounted crank drive (ANC) reduces friction, heat generation, wear. For long service life of drive also at extreme sawing.

### Aggressive orbital action

Aggressive orbital action by vertical hacking motion of saw blade provides forceful, fast forward feed, excellent chip flow and long service life of saw blades. Fixed orbital action, running in needle bearings, ensures long-lasting and forceful

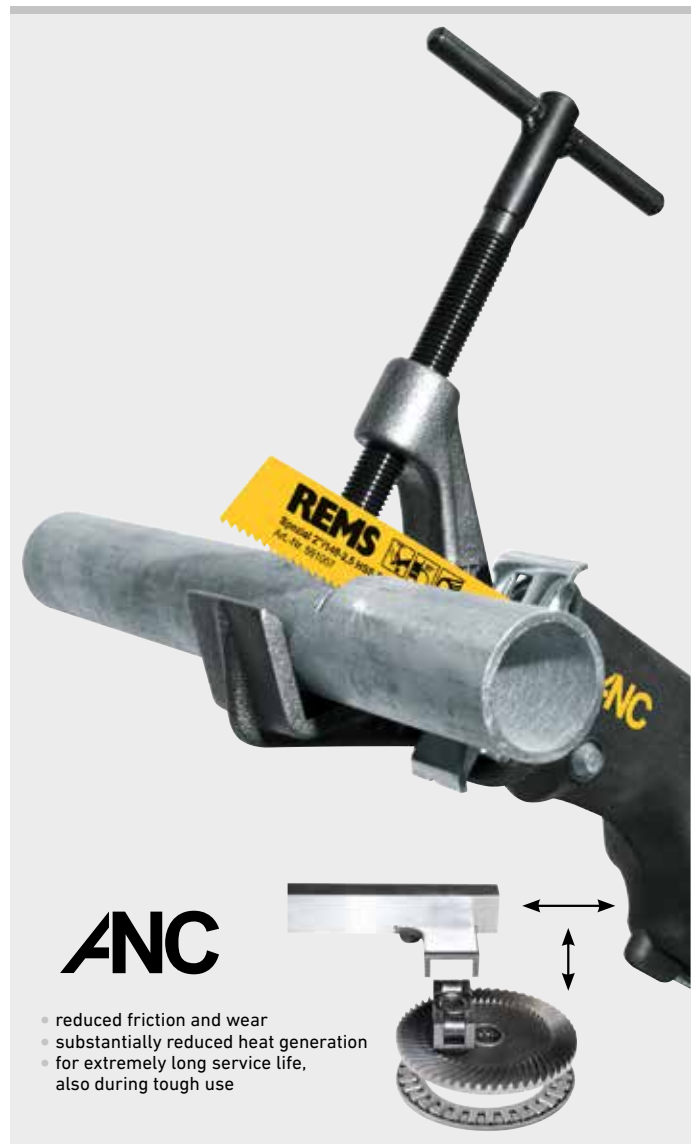

German Quality Product

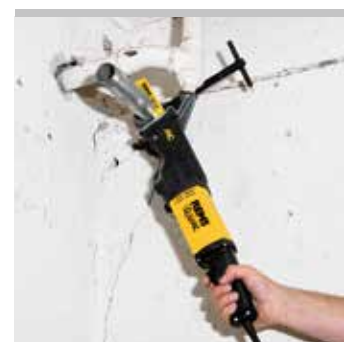
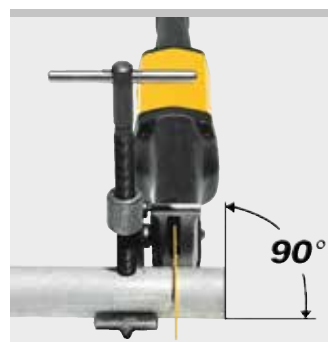

# REMS Tiger/VE/SR

## Electric reciprocating pipe saws

sawing also during extreme load conditions, e.g. sawing of steel pipe. Adjustable mechanisms with a great variety of parts and a reduced system stability do not withstand the high feed forward pressure and the heavy-duty requirements of forceful cutting of steel pipes, particularly when a guide support with leverage is being used.

### Ideal speed (REMS Tiger)

Deliberately fixed speed. Therefore optimum cutting speed for maximum protection of motor and gear and maximum service life of saw blades. The ideal cutting speed of 2,400 rpm has been determined by extensive sawing tests with steel pipe which lead to optimum performance in combination with the aggressive, fixed orbital action, guide support and REMS special saw blade.

### Vario-Electronic (REMS Tiger VE)

Electronic stepless speed control of drive unit for sensitive start-sawing and for speed selection during sawing according to the material. Also for plunge-cut sawing. The stroke speed can be continuously controlled by variable pressure on the safety switch from 0 to 2,400 rpm (accelerator switch).

### Speed Regulation (REMS Tiger SR)

Stepless electronic speed control of drive unit for selecting the stroke according to the material. Ideal for sawing stainless steel pipe, cast pipe and for sawing boilers, tanks, bath tubs etc. Also for plunge-cut sawing. The number of strokes is steplessly adjustable on the dial from 700 to 2,200 rpm.



Anywhere,  
without vice!



German Quality Product



### Supply format

**REMS Tiger Set.** Electric reciprocating pipe saw for effortless, fast, right angle sawing with guide support and for free-hand sawing. Drive unit with straight machine handle, maintenance-free, water and dust resistant oscillating drive with allround needle bearing mounted crank drive (ANC), aggressive orbital action, powerful universal motor 230 V or 110 V, 50–60 Hz, 1050 W, safety tip switch. Fixed stroke 2,400 rpm. Overload protection. Universal saw blade clamp. Hexagon key. Guide support 2". 2 pcs. REMS special saw blades 2"/140-3.2. In sturdy steel case.

Art.-No.	€
560020R220	725,56

Other voltages, also 48 V on request.

### Supply format

**REMS Tiger VE Set.** Electric reciprocating pipe saw with Vario-Electronic for effortless, fast, right angle sawing with guide support and for free-hand sawing. Drive unit with D-shape handle, maintenance-free, water and dust resistant oscillating drive with allround needle bearing mounted crank drive (ANC), aggressive orbital action, powerful universal motor 230 V or 110 V, 50–60 Hz, 1050 W, safety tip switch. Electronic stepless speed control (acceleration switch) 0 to 2,400 rpm. Universal saw blade clamp. Hexagon key. Guide support 2". 2 pcs. REMS special saw blades 2"/140-3.2. In sturdy steel case.

Art.-No.	€
560027R220	746,32

Other voltages on request.

### Supply format

**REMS Tiger SR Set.** Electric reciprocating pipe saw with speed regulation (SR) for effortless, fast, right angle sawing with guide support and for free-hand sawing. Drive unit with straight machine handle, maintenance-free, water and dust resistant oscillating drive with allround needle bearing mounted crank drive (ANC), aggressive orbital action, powerful universal motor 230 V or 110 V, 50–60 Hz, 1400 W, safety tip switch. Stepless electronic speed control 700 to 2,200 rpm with sensitive start-sawing, speed generator, temperature control and stall protection. Universal saw blade clamp. Hexagon key. Guide support 2". 2 pcs. REMS special saw blades 2"/140-3.2. In sturdy steel case.

Art.-No.	€
560026R220	818,98

Other voltages on request.

### Accessories

Description	Art.-No.	€
<b>REMS Tiger drive unit</b>	560000R220	621,76
<b>REMS Tiger VE drive unit</b>	560008R220	642,52
<b>REMS Tiger ANC SR drive unit</b>	560001R220	715,18
<b>REMS saw blades</b> see page 68–69.		
<b>Guide support 2"</b> , for pipes $\varnothing$ 1/2–2"	563000R	165,04
<b>Guide support 4"</b> , for pipes $\varnothing$ 2 1/2–4"	563100R	227,32
<b>Guide support 6"</b> , for pipes $\varnothing$ 5–6"	563200R	258,46
<b>Chain guide support 6"</b> , for $\varnothing$ 1/2–6" pipes and other profiles	563203R	205,52
<b>Dual purpose holder</b> for sawing and threading, with REMS Tiger and REMS Amigo E, Amigo, Amigo 2	543100	264,69
<b>Protective cap for guide support 2"</b> , 4" and 6", for clamping of thin-walled material	563008R	20,14
<b>Steel case</b>	566051R	82,73



3.0 kg	1050 W	230 V	n ideal	ANC



3.0 kg	1050 W	230 V	VE	ANC



3.1 kg	1400 W	230 V	SR	ANC



# REMS Tiger pneumatic

Pneumatic reciprocating pipe saw

Powerful, robust, handy compressed air tool with force-transmitting guide holder for effortless, fast, right-angled sawing everywhere on site, without a vice. Also for universal free-hand sawing. Ideal for use in dangerous, e.g. in wet environment. For assembly, dismantling, repair.

Ideal for steel pipes and others.

Many materials, e.g. wood, wood with nails, pallets, metal, even stainless steel, cast iron, breeze blocks, plaster boards, pumice stone, brick

For materials that are difficult to cut, e.g. stainless steel pipes, hard cast iron, use the REMS Tiger SR with electronic stroke speed control.

## REMS Tiger pneumatic – for sawing in dangerous environment.

**Saws effortless, fast, right-angle. Force transmitting guide support for 400 % more sawing power. Sturdy, square lift rod. Oscillating drive with ANC.**

**Aggressive orbital action for fast feed forward sawing and long service life of saw blades. Universal saw blade clamp.**

### Design

Robust, job site-proven. Slender, handy design. Super light, only 3.8 kg. Can be used anywhere. Ergonomically shaped front housing grip with slip resistant, heat insulating protection cover with soft grip, for forceful feed forward during free-hand sawing. Swivel support shoe for safe guiding of the saw on the material to be sawn. High sliding silicone gasket protects gear against water and dust. Powerful pneumatic motor with ample reserve capacity, 1000 W. Stroke speed control (accelerator switch) 0 to 1,700 rpm. Operating pressure 6 bar, air consumption  $\leq 1.6 \text{ m}^3/\text{min}$ . Safety switch with lock.

Additional description see REMS Tiger, page 62–63.



German Quality Product



Info

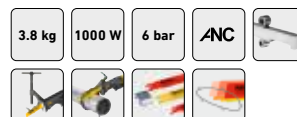

## Supply format

**REMS Tiger pneumatic Set.** Pneumatic reciprocating pipe saw for effortless, fast, right angle sawing with guide support and for free-hand sawing. Drive unit with straight machine handle, maintenance-free, water and dust resistant oscillating drive with allround needle bearing mounted crank drive (ANC), aggressive orbital action, powerful pneumatic 1000 W, operating pressure 6 bar, safety switch with lock. Stroke speed control (accelerator switch) 0 to 1,700 rpm. Air inlet hose, air outlet hose. Universal saw blade clamp. Hexagon key. Guide support 2". 2 pcs. REMS special saw blades 2"/140-3.2. In sturdy steel case.

	Art.-No.	€
	560022	2.176,69

## Accessories

Description	Art.-No.	€
<b>REMS saw blades</b> see page 68–69.		
<b>REMS Tiger pneumatic drive unit</b>	560002R	1.865,29
<b>Guide support 2"</b> , for pipes $\varnothing \frac{1}{2}$ –2"	563000R	165,04
<b>Guide support 4"</b> , for pipes $\varnothing 2\frac{1}{2}$ –4"	563100R	227,32
<b>Guide support 6"</b> , for pipes $\varnothing 5$ –6"	563200R	258,46
<b>Chain guide support 6"</b> , for $\varnothing \frac{1}{8}$ –6" pipes and other profiles	563203R	205,52
<b>Dual purpose holder</b> for sawing and threading, with REMS Tiger and REMS Amigo E, Amigo, Amigo 2	543100	264,69
<b>Protective cap for guide support 2"</b> , 4" and 6", for clamping of thin-walled material	563008R	20,14
<b>Steel case</b>	566051R	82,73







**REMS**

Spezial 2" / 140-3,2 HSS-Bi Made in Germany  
Art.-Nr. 501001

**ANC**

**REMS**  
22V VR

**REMS**  
22V OPEN

**REMS**  
22V

**REMS 22V 9.0**

**REMS 55A 8.0**

**REMS**

**REMS**

**REMS**

**REMS**

**REMS**

**REMS**

**REMS**

**REMS**

**REMS**

**REMS**

Powerful, mobile, handy power tool with force-transmitting guide holder for effortless, fast, right-angled sawing everywhere on site, without a vice. Also for universal free-hand sawing. Only 3.4 kg. Ideal for assembly, dismantling, repair. Li-Ion 22V Technology. For battery and corded operation.

Ideal for steel pipes and others.

Many materials, e.g. wood, wood with nails, pallets, metal, even stainless steel, cast iron, breeze blocks, plaster boards, pumice stone, brick

## REMS Tiger 22V VE – the saw for the pipe fitter.

**Saws effortless, fast, right angle. Mobile, handy, light. Li-Ion 21.6V, 9.0Ah battery, for approx. 80 1" steel pipe cuts with guide holder for approx. 140 1" steel pipe cuts without guide holder with one battery charge\*.**

### Power-transferring guide support

400% more sawing power for effortless, ultra-fast sawing of pipes and profiles, e.g., 2" steel pipe in just 8 s. For assembly and disassembly. Guide support with 5-fold power-transferring leverage allows effortless, fast, right-angled sawing everywhere on site, also free-hand without a pipe vice. Ideal handling, very quick and easy operation, only one handle for clamping and sawing. No free-swinging chain. No danger of jamming by limitation of swing angle. For optimum in-feed with guide support a straight machine handle is advantageous.

### Right angle sawing

Right angle cut thanks to REMS guide support and REMS special saw blade. Essential for subsequent operations in pipe installation.

### REMS special saw blade

REMS special saw blade (page 68), extra thick, rigid and unbendable, double tang, absolutely essential for right-angled sawing and fast disassembly of steel pipes with force-transmitting guide holder.

### REMS universal saw blade

Only 1 REMS universal saw blade (page 68) for all sawing work instead of many different saw blades. Double tang for free-hand sawing and sawing with guide holder.

### REMS saw blades

Full range of REMS saw blades for free-hand sawing of different materials (page 69).

### Universal saw blade clamp

All saw blades – with universal or double tang – can be clamped without changing or turning the saw blade thrust piece.

### Design

Robust, job site-proven. Mobile, handy, light. Drive unit with battery pack weighs only 3.4 kg. Slim form. Can be used anywhere. Ergonomically shaped front housing grip with slip resistant protection cover for forceful feed forward during free-hand sawing. Practical D-shaped handle with soft grip. Swivel support shoe for safe guiding of the saw on the material to be sawn. High sliding silicone gasket protects gear against water and dust. Powerful 21.6 V battery motor with ample reserve capacity, 500 W output. Safety tip switch. Machine status check with overload protection of the drive unit against too high currents, with overheating protection by motor temperature monitoring (NTC), with electronic battery charging status check with charging level indication by a 2-coloured green/red LED.

### Sturdy, square lift rod

In special solid steel, mounted precisely in needle bearings towards the force direction and along the complete stroke length, for distortion-free, precise cutting also during tough use. For extremely long service life. Drive rod runs in an enclosed housing for safe work.

### Oscillating drive with ANC

Super stable, water and dust resistant, maintenance-free oscillating drive for simultaneous generation of sawing stroke and orbital action of lift rod and saw blade. Allround needle bearing mounted crank drive (ANC) reduces friction, heat generation, wear. For long service life of drive also at extreme sawing.

### Vario-Electronic

Electronic stepless speed control of drive unit for sensitive start sawing and for speed selection during sawing. The speed is controlled by pressing the tip switch steplessly from 0 to 1,900 rpm (acceleration switch).

### Aggressive orbital action

Aggressive orbital action by vertical hacking motion of saw blade provides forceful, fast forward feed, excellent chip flow and long service life of saw blades. Fixed orbital action, running in needle bearings, ensures long-lasting and forceful sawing also during extreme load conditions, e.g. sawing of steel pipe.



- reduced friction and wear
- substantially reduced heat generation
- for extremely long service life, also during tough use

German Quality Product



## Battery or mains operation

Li-Ion 22V Technology. Highly resistant Li-Ion 21.6V battery with 9.0 Ah capacity, for long service life. Light and powerful, for approx. 80 1" steel pipe cuts with guide holder or approx. 135 1" steel pipe cuts without guide holder with one battery charge\*. Graduated charging status check by coloured LEDs. Operating temperature range - 10 to + 60 °C. No memory effect for maximum battery power. Rapid charger 100-240V, 90W. Rapid charger 100-240V, 290W, for shorter charging times, as accessory. Voltage supply 220-240V/21.6V, 40A output, for mains operation instead of Li-Ion battery 21.6 V, as accessory.

## Universal saw blade clamp

All saw blades - with universal or double tang - can be clamped without changing or turning the saw blade thrust piece.

## Supply format

**REMS Tiger 22 V VE Set.** Cordless pipe reciprocating saw with Vario Electronics (VE) for effortless, fast, right-angled sawing with guide holder and for free-hand sawing. Drive unit with spade handle, maintenance-free, water and dust proof oscillation drive with all-round needle bearing crank drive (ANC), aggressive orbital stroke, powerful 21.6V, 500 W battery motor, safety switch. Continuous, electronic stroke speed control (accelerator switch) 0 to 1900 rpm. Machine status check with overload protection, temperature monitoring, battery charging status check. Li-Ion 21.6V, 9.0Ah battery, 100-240V, 50-60 Hz, 90W rapid charger. Universal saw blade clamp. Hexagon key. Guide support 2". 2 pcs. REMS special saw blades 2"/140-3.2. In sturdy steel case.

	Art.-No.	€
	560053R220	1.347,32

Other voltages on request.



## Accessories

Description	Art.-No.	€
<b>REMS Tiger 22 V VE drive unit, without battery</b>	560011R22	808,60
<b>REMS saw blades</b> see page 68-69.		
<b>Guide support 2"</b> , for pipes Ø ½-2"	563000R	165,04
<b>Battery Li-Ion 21.6V, 9.0 Ah</b>	571583R22	414,16
<b>Rapid charger 100-240V, 50-60 Hz, 90W</b>	571585R220	175,42
<b>Rapid charger 100-240V, 50-60 Hz, 290W</b>	571587R220	414,16
<b>Voltage supply 220-240V/21.6V, 50-60 Hz, 40 A</b> , for mains operation instead of battery Li-Ion 21.6V	571578R220	517,96
<b>Steel case with inlay</b>	566030R	128,71
<b>REMS Lumen 2800 22V</b> , cordless LED flood light, see page 111		



# REMS special saw blades

For REMS Tiger/VE/SR, Tiger pneumatic, Tiger 22V VE and other makes

Special saw blades for right angle sawing and for fast dismantling of steel pipes with power transmitting guide support.

Steel pipes

## REMS special saw blades – for right-angled sawing with force-transmitting guide holder, for 400% more sawing power.

Specially developed for REMS Tiger.

Absolutely essential for right angle sawing and for fast dismantling with power transmitting guide support. This produces multiple thrust pressure by a five-fold force-transmitting leverage, for 400% more sawing power. Normal saw blades with single tang do not withstand the high feed pressure during sawing with guide support, they break at the mounting point.

For this reason, extra thick REMS special saw blade, resistant to bending and distortion.

Double tang mounting with exceptionally wide clamping face ensures accurate seating and high stability.

Coarse, corrugated tooth pattern for rapid sawing. Long service life.

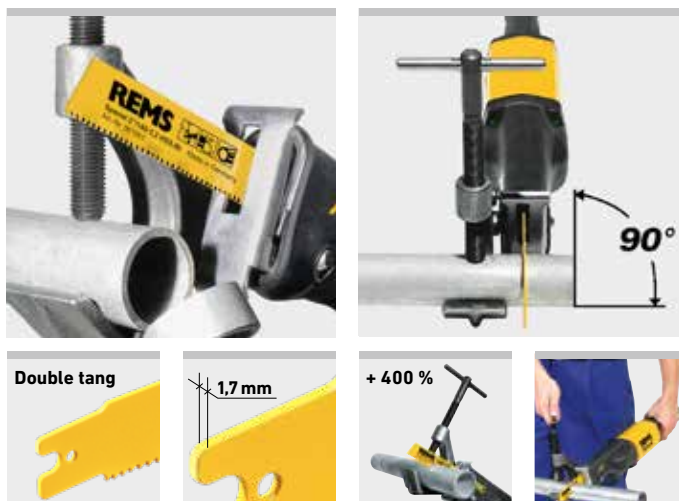

German Quality Product



REMS special saw blades → REMS Tiger, etc.	Ø inches/ Length mm	Tooth pitch mm	Material*	Teeth	Colour			Art.-No.	€
<b>REMS special saw blade 2"/140-2.5</b> steel pipes ≤ 2"	2"/140	2.5	HSS-Bi		yellow	5		561007 R05	<b>62,18</b>
<b>REMS special saw blade 2"/140-3.2</b> steel pipes ≤ 2"	2"/140	3.2	HSS-Bi		yellow	5		561001 R05	<b>58,02</b>
<b>REMS special saw blade 4"/200-3.2</b> steel pipes ≤ 4"	4"/200	3.2	HSS-Bi		yellow	5		561002 R05	<b>76,92</b>
<b>REMS special saw blade 6"/260-3.2</b> steel pipes ≤ 6"	6"/260	3.2	HSS-Bi		yellow	5		561008 R05	<b>99,54</b>

For hard-to-machine materials, e.g. stainless steel pipes, hard cast iron pipes, use the finer toothed REMS universal saw blade instead of the REMS special saw blade in combination with REMS Tiger SR with electronic speed regulation (page 63).

# REMS universal saw blades

For REMS Cat VE, Tiger/VE/SR, Cat 22V VE and other makes

Universal saw blade for free-hand sawing and for sawing with power transmitting guide support. Instead of many different saw blades.

Many materials, e.g. wood, wood with nails, pallets, metal, even stainless steel, cast iron, breeze blocks, plaster boards, pumice stone, brick

Highly flexible, also ideal for sawing flush with the wall.

## REMS universal saw blades – for all sawing jobs.

Only 1 universal saw blade instead of many different saw blades for all sawing jobs.

Resilient material, highly flexible, also for flush-to-wall sawing.

Double tang mounting with exceptionally wide clamping face for accurate seating and high stability. Also for sawing with power transmitting guide support. Single tang saw blades are unable to cope with the high thrust pressure when sawing with a guide holder, they break at the clamping point.

Alternating tooth pitch (combi-teeth) for fast, smooth cut, very highly hardened in the teeth area. Straight-set teeth.

Thus outstanding cutting performance and prolonged service life.

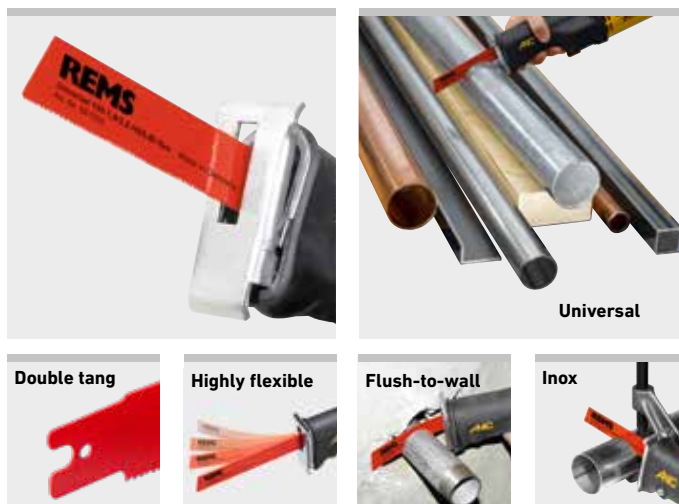

German Quality Product



REMS universal saw blades → REMS Tiger, REMS Cat, etc.	Length mm	Tooth pitch mm	Material*	Teeth	Colour			Art.-No.	€
<b>REMS universal saw blade 100-1.8/2.5</b> for all sawing work	100	Combo 1.8/2.5	HSS-Bi flexible		red	5		561006 R05	<b>39,96</b>
<b>REMS universal saw blade 150-1.8/2.5</b> for all sawing work	150	Combo 1.8/2.5	HSS-Bi flexible		red	5		561005 R05	<b>57,19</b>
<b>REMS universal saw blade 200-1.8/2.5</b> for all sawing work	200	Combo 1.8/2.5	HSS-Bi flexible		red	5		561003 R05	<b>75,67</b>
<b>REMS universal saw blade 300-1.8/2.5</b> for all sawing work	300	Combo 1.8/2.5	HSS-Bi flexible		red	5		561004 R05	<b>111,79</b>

Also for nail-embedded wood, pallets. For hard-to-machine materials, e.g. stainless steel pipes, hard cast iron pipes, lower speed required, e.g. by using REMS Tiger SR with electronic speed regulation (page 63).





# REMS saw blades

For REMS Puma VE, Cat VE, Tiger/VE/SR,  
Cat 22V VE, Tiger 22V VE and other makes

## Saw blades for free-hand sawing for different materials.





















Alternating tooth pitch (combi-teeth) for fast, smooth cut, also when sawing mixed materials (wood/metal).

Flexible saw blades, also for sawing flush with wall.

-  Corrugated teeth for smooth cut with low tooth pitch.
-  Straight-set teeth for aggressive cut with coarse tooth pitch.
-  Straight teeth for saw blades with very wide carbide teeth.
-  Carbide-granulate for materials that are difficult to cut.

















German Quality Product



















REMS saw blades for metal → REMS Puma, REMS Cat, REMS Tiger, etc.	Length mm	Tooth pitch mm	Material*	Teeth	Colour			Art.-No.	€
<b>REMS saw blade 150-1</b> sheet metal, metal, also stainless steel, ≥ 1.2 mm	150	1	HSS-Bi flexible		red	5		561105R05	25,74
<b>REMS saw blade 200-1</b> sheet metal, metal, also stainless steel, ≥ 1.2 mm	200	1	HSS-Bi flexible		red	5		561106R05	33,74
<b>REMS saw blade 90-1.4</b> , curved blade metal, also stainless steel, ≥ 1.5 mm	90	1.4	HSS-Bi		red	5		561107R05	23,87
<b>REMS saw blade 150-1.4</b> metal, also stainless steel, ≥ 1.5 mm	150	1.4	HSS-Bi flexible		red	5		561104R05	26,88
<b>REMS saw blade 200-1.4</b> metal, also stainless steel, ≥ 1.5 mm	200	1.4	HSS-Bi flexible		red	5		561108R05	33,94
<b>REMS saw blade 100-1.8</b> metal, also stainless steel, ≥ 2 mm	100	1.8	HSS-Bi flexible		red	5		561101R05	23,04
<b>REMS saw blade 150-1.8</b> metal, also stainless steel, ≥ 2 mm	150	1.8	HSS-Bi flexible		red	5		561103R05	26,88
<b>REMS saw blade 200-1.8</b> metal, also stainless steel, ≥ 2 mm	200	1.8	HSS-Bi flexible		red	5		561102R05	33,74
<b>REMS saw blade 200-2.5</b> metal, also stainless steel, ≥ 3 mm	200	2.5	HSS-Bi flexible		red	5		561109R05	33,74
<b>REMS saw blade 280-2.5</b> metal, also stainless steel, ≥ 3 mm	280	2.5	HSS-Bi flexible		red	5		561112R05	42,77

German Quality Product



REMS saw blades for wood and metal → REMS Puma, REMS Cat, REMS Tiger, etc.	Length mm	Tooth pitch mm	Material*	Teeth	Colour			Art.-No.	€
<b>REMS saw blade 210-1.8/2.5</b> round tip, no sticking pallets, wood, wood with nails, metal ≥ 2.5 mm	210	Combo 1.8/2.5	HSS-Bi flexible		black	5		561113R05	34,77
<b>REMS saw blade 150-2.5</b> wood, wood with nails, pallets, metal ≥ 3 mm	150	2.5	HSS-Bi flexible		black	5		561110R05	25,74
<b>REMS saw blade 225-2.5</b> , extra thick, for disassembly wood, wood with nails, metal ≥ 3 mm	225	2.5	HSS-Bi		black	3		561114R03	33,11
<b>REMS saw blade 300-2.5</b> , extra thick, for disassembly wood, wood with nails, metal ≥ 3 mm	300	2.5	HSS-Bi		black	3		561116R03	44,12
<b>REMS saw blade 300-4.2</b> wood	300	4.2	WS		black	5		561111R05	31,45
<b>REMS saw blade 225-3.2/5.0</b> wood, wood with nails	225	Combo 3.2/5.0	HSS-Bi flexible		black	5		561117R05	39,24
<b>REMS saw blade 290-5.0/6.35</b> green wood	290	Combo 5.0/6.35	WS		black	5		561118R05	42,77
<b>REMS saw blade 150-6.35</b> wood	150	6.35	WS		black	5		561119R05	18,17



REMS saw blades for different purposes → REMS Puma, REMS Cat, REMS Tiger, etc.	Length mm	Tooth pitch mm	Material*	Teeth	Colour			Art.-No.	€
<b>REMS saw blade 150-4.2</b> breeze blocks, plasterboard	150	4.2	WS		white	5		561115R05	22,52
<b>REMS saw blade 225-8.5</b> breeze blocks, hard wood	225	8.5	HM		white	1		561120R01	58,54
<b>REMS saw blade 300-8.5</b> breeze blocks, hard wood	300	8.5	HM		white	1		561121R01	70,17
<b>REMS saw blade 400-8.5</b> breeze blocks, hard wood	400	8.5	HM		white	1		561122R01	100,69
<b>REMS saw blade 235-12</b> breeze blocks, pumice, brick	235	12	HM		white	1		561123R01	81,48
<b>REMS saw blade 300-12</b> breeze blocks, pumice, brick	300	12	HM		white	1		561124R01	94,35
<b>REMS saw blade 300-12</b> , extra high blade breeze blocks, pumice, brick	300	12	HM		white	1		561125R01	111,79
<b>REMS saw blade 200</b> cast iron etc.	200		HM-G		white	2		561126R02	33,63



# REMS Turbo Cu-INOX

Circular pipe sawing machine

Compact, portable circular pipe sawing machine for burr-reduced, right angle and rapid sawing. For stainless steel pipes, carbon steel pipes and copper pipes of the press fitting systems etc. Also for cutting thin-walled sections for front-wall installation. For job site and workshop.

Stainless steel pipes, carbon steel pipes, copper pipes and other materials	≤ Ø 76 mm
REMS saw blade	Ø 225 mm

**REMS Turbo Cu-INOX – burr-reduced, right angle, rapid. Burr-reduced sawing through double clamping vice. Powerful, e.g. Ø 22 mm in only 4 s. Easy to transport.**

## Ideal for pressfitting systems

In accordance with requirements:

**Dry sawing**, so no damage to O-rings from lubricants.

**Burr-reduced** through double clamping vice.

**Optimum cutting** speed prevents degradation of pipe material through overheating.

## Design

Compact, robust, job site-proven. Small in size, handy, portable, only 17 kg. Easy sawing through favourable leverage effect. Fast saw blade change. Precise sawing. Mark on the saw blade protection cover showing the saw blade cutting line. Connection for driving outer/inner pipe deburrer REMS REG 10–54 E. For workbench, stand or wheel stand as an accessory, for easy transport, optimum working height and stable positioning.

## Universal double clamping vice

Robust, easy-running universal double clamping vice for burr-reduced sawing. Both pipe ends remain securely clamped during sawing. Easy, secure clamping also of thin-walled pipes through inclined jaw. Only one strong clamping spindle for both clamping sides ensures even, effortless and secure clamping of the material.

## Drive

Robust gear, precisely mounted in roller and needle bearings, maintenance-free. Proven universal motor, 500 W. Powerful, e.g. stainless steel pipe Ø 22 mm in only 4 s. Ideal speed 60 rpm for optimum cutting speed and smooth sawing.

## REMS saw blades

Top German quality. REMS circular saw blade HSS 225 × 2 × 32 mm, 220 teeth, for metal, adjusted to the efficiency of REMS Turbo Cu-INOX for sawing stainless steel tubes. Specially fine-toothed, hardened and ground. For easy and exact sawing. Prolonged durability. REMS circular saw blade HSS-E (cobalt alloyed) 225 × 2 × 32 mm, 220 teeth, for metal, for even better durability. Specially fine-toothed, hardened and ground.

## Outer/inner pipe deburrer

Outer/inner pipe deburrer REMS REG 10–54 E for pipes Ø 10–54 mm, Ø ½–2 ¼", for electric drive with the REMS Turbo Cu-INOX pipe circular sawing machine and others, see page 99.

## Supply format

**REMS Turbo Cu-INOX Basic.** Circular pipe saw with universal double clamping vice for burr-reduced, right angle, rapid sawing. For stainless steel pipes, carbon steel pipes and copper pipes of the press fitting systems etc. Also for cutting thin-walled sections for front-wall installation. For REMS saw blade Ø 225 mm. With maintenance-free gear, proven universal motor 230 V or 110 V, 50–60 Hz, 500 W. Safety tip switch, saw blade protection cover. Speed 60 rpm. Ring spanner. Hexagon key. Without saw blade. For workbench, stand or wheel stand. In a carton.

	Art.-No.	€
	849006R220	1.287,12

Other voltages on request.

## Accessories

Description	Art.-No.	€
<b>REMS circular saw blade HSS</b> for metal, specially for stainless steel pipes, fine-toothed, 225 × 2 × 32 mm, 220 teeth.	849703R	222,13
<b>REMS circular saw blade HSS-E</b> (cobalt alloyed) circular saw blade HSS-E (cobalt alloyed) toothing, 225 × 2 × 32 mm, 220 teeth. Very long service life.	849706R	309,32
<b>REMS REG 10–54 E</b> outer/inner pipe deburrer, see page 99		
<b>Stand</b>	849315R	216,94
<b>Wheel stand</b>	849310R	351,88
<b>REMS Jumbo</b> , folding workbenches, see page 106.		
<b>REMS Herkules</b> , material supports, see page 107.		



German Quality Product



Info



# REMS Turbo K

Universal circular metal sawing machine with automatic cooling lubricant unit

Compact, mobile, universal circular metal sawing machine for installation, metal working and industry. For job site and workshop.

↶	○	□	▭	└	●	■	▬
90° ⊕	78	55	70 × 50	50 × 50	40	40	50 × 30
45° ⊕	60	55	60 × 40	50 × 50	40	40	50 × 30

REMS saw blade Ø 225 mm

**REMS Turbo K – the most powerful in its class.**  
**Progressive drive, e.g. 2" steel pipe in only 5 s.**  
**Easy to transport.**

### Design

Compact, robust, job site-proven. Small in size, handy, portable, complete only 22 kg. Automatic cooling lubricant unit. Easy sawing through favourable leverage effect. Fast saw blade change. Precise sawing. For workbench, stand or wheel stand as an accessory, for easy transport, optimum working height and stable positioning.

### Universal vice

Robust, easy-running universal vice with strong clamping spindle and large clamping lever for effortless, secure clamping of the material. Standard with clamp insert for thin-walled pipes. Quick setting of bevel angle thanks to clearly laid out scale and clamping lever. Simple, sturdy length stop.

### Drive

Robust, maintenance-free gear, precisely mounted in roller and needle bearings. Proven universal motor, 1200 W. Extremely strong and powerful, e.g. 2" steel pipe in only 5 s. Ideal speed 115 rpm for fast and smooth sawing.

### REMS saw blades

Top German quality. REMS universal circular saw blade HSS 225 × 2 × 32 mm for metal, 120 teeth, adjusted to the efficiency of REMS Turbo K. Specially toothed, hardened and ground. For easy and exact sawing. REMS universal circular saw blade HSS 225 × 2 × 32 mm, 220 teeth, adjusted for sawing stainless steel. Specially fine-toothed, hardened and ground. For an even better durability, REMS universal circular saw blade HSS-E (cobalt alloyed) 225 × 2 × 32 mm, 220 teeth. Specially fine-toothed, hardened and ground.

### Kühlschmierstoffe

REMS Sanitol and REMS Spezial (page 47). High lubricating and cooling effect. Essential for clean cuts, long service life of saw blades and machine.



German Quality Product



Info

### Supply format

**REMS Turbo K Basic.** Universal circular metal sawing machine with automatic cooling lubricant unit. For straight cuts and bevel cuts up to 45°. For REMS saw blade Ø 225 mm. Maintenance-free gear. Proven, powerful universal motor 230 V or 110 V, 50–60 Hz, 1200 W. Safety tip switch, saw blade protection cover, length stop. Clamp insert for thin-walled pipes. Speed 115 rpm. Ring spanner. Hexagon key. 1 filling of cooling lubricant REMS Spezial. Without saw blade. For workbench, stand or wheel stand. In a carton.

	Art.-No.	€
	849007R220	1.614,09

Other voltages on request.

### Accessories

Description	Art.-No.	€
<b>REMS universal circular saw blade HSS</b> for metal, 225 × 2 × 32 mm, 120 teeth	849700R	192,03
<b>REMS circular saw blade HSS for metal,</b> fine-toothed, 225 × 2 × 32 mm, 220 teeth	849703R	222,13
<b>REMS circular saw blade HSS-E</b> (cobalt alloyed) for metal, fine-toothed, 225 × 2 × 32 mm, 220 teeth. Very long service life.	849706R	309,32
<b>Electronic speed regulator</b> for hard-to-machine materials, e.g. stainless steel pipes, hard cast iron pipes. Fixed, optimum speed.	565051R220	279,22
<b>Cooling lubricants</b> see page 47.		
<b>Stand</b>	849315R	216,94
<b>Wheel stand</b>	849310R	351,88
<b>REMS Jumbo,</b> folding workbenches, see page 106.		
<b>REMS Herkules,</b> material supports, see page 107.		













# Cutting

## Chamfering

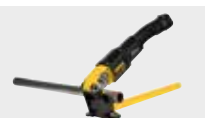
## Deburring

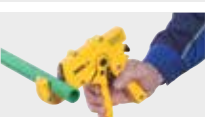
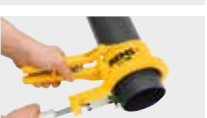
## Calibrating

	<b>Pipe cutters</b>	<b>74</b>
	<b>Cutter wheels</b>	<b>81</b>
	<b>Electric pipe cutter/ Cordless pipe cutter</b>	<b>82</b>
	<b>Pipe cutting machines</b>	<b>84</b>
	<b>Pipe shears</b>	<b>90</b>
	<b>Pipe cutting and pipe chamfering tools</b>	<b>94</b>
	<b>Pipe deburrers</b>	<b>97</b>
	<b>Calibrating tools and outer-inner pipe deburrer</b>	<b>100</b>

Robust quality tools for cutting pipes.  
Meets high demands and long service life.

Steel pipes  $\varnothing$  1/8 – 4",  $\varnothing$  10 – 115 mm

### REMS RAS St – quality pipe cutters.

Solid body in forged steel.

Robust spindle, long spindle guidance and hardened back pressure rollers provide exact alignment to the pipe and a long service life.

Ergonomic, wide handle provides a powerful in-feed of spindle.

Broad, precise cutter wheel bearing on a hardened, non rotating wheel shaft guarantees a right angle cut.

Specially hardened cutter wheel in approved, tough-hard REMS die-steel quality ensures a long service life.

Cutter wheel protected against touching the back pressure rollers by in-feed limitation.

Only 1 cutter wheel for pipes  $\varnothing$  1/8 – 4" (10 – 115 mm), wall thickness  $s \leq 8$  mm, suitable for both pipe cutters. Cutter wheel for pipes  $\varnothing$  1 – 4" to wall thickness  $s \leq 12.5$  mm available as accessory.



German Quality Products



Info

### Supply format

REMS RAS St. Pipe cutter for steel pipes. With cutter wheel. In a carton.

Description	Pipes $\varnothing$ mm/inch	Wall thickness $s \leq$ mm	Art.-No.	€
St 1/8 – 2"	1/8 – 2" 10 – 60	8	113000R	227,32
St 1 1/4 – 4"	1 1/4 – 4" 30 – 115	8	113100R	414,16

### Accessories

Description	$s \leq$ mm	Art.-No.	€
REMS cutter wheel St 1/8 – 4", $s$ 8 for REMS RAS St 1/8 – 2" and St 1 1/4 – 4"	8	341614R	15,47
REMS cutter wheel St 1 – 4", $s$ 12 for REMS RAS St 1 1/4 – 4"	12.5	381622R	35,60



# REMS RAS Cu-INOX

## Pipe cutters

Robust quality tools for cutting tubes.  
Particularly suited for cutting stainless steel tubes.

Copper tubes, thin-walled  
stainless steel tubes, thin-walled  
steel, aluminium, brass tubes Ø 3 – 120 mm  
Ø 1/8 – 4"

### REMS RAS Cu-INOX – for places with difficult access.

Small, handy, specially for use in restricted spaces.  
Robust design and hardened back pressure rollers provide exact alignment to the tube and a long service life.

Large operating knob in metal for easy in-feed and cutting.  
Broad, precise cutter wheel bearing on a hardened, non rotating wheel shaft guarantees a right angle cut.

Specially hardened cutter wheel in approved, tough-hard REMS die-steel quality ensures a long service life. Fast changing of cutter wheel without tools by cutter wheel axle with ball catch. Cutter wheel protected against touching the back pressure rollers by in-feed limitation.

REMS RAS Cu-INOX 3–28 S Mini with needle bearing cutter wheel and needle bearing counter-pressure rollers for very easy cutting.



### Supply format

**REMS RAS Cu-INOX.** Pipe cutter for copper tubes, thin-walled stainless steel tubes, thin-walled steel, aluminium, brass tubes. With cutter wheel. In blister pack.

Description	Pipes Ø mm/inch	Wall thickness s ≤ mm	Art.-No.	€
<b>Cu-INOX 3–16</b>	3–16 1/8–5/8"	4	113200R	<b>28,55</b>
<b>Cu-INOX 3–25</b>	3–25 1/8–1"	4	113230R	<b>34,57</b>
<b>Cu-INOX 3–28 Mini</b>	3–28 1/8–1 1/8"	4	113240R	<b>39,55</b>
<b>Cu-INOX 3–28 S Mini</b> on needle bearings	3–28 1/8–1 1/8"	4	113241R	<b>55,74</b>



Info



### REMS RAS Cu-INOX – the compact version with telescopic spindle.

Telescopic spindle. Easy, quick adjustment in both directions.  
Compact design for tough use.

Sturdy telescopic spindle, long spindle guidance and 4 specially hardened back pressure rollers ensure exact alignment to the tube, easy in-feed, easy cutting and precise, right angle cut.

Ergonomic, handy operating knob in metal for easy work and long service life.  
Specially hardened cutter wheel in approved, tough-hard REMS die-steel quality ensures a long service life. Fast changing of cutter wheel without tools by cutter wheel axle with ball catch. Cutter wheel protected against touching the back pressure rollers by in-feed limitation.

REMS RAS Cu-INOX 3–35 S with needle bearing cutting wheel and needle bearing counter-pressure rollers for very easy cutting.

Integrated pipe deburring device, on rotating bearing, adapts to the workpiece edge to be deburred.

Specially hardened and ground universal deburring blade guarantees easy deburring and extremely long life.

Fast, simple blade change.

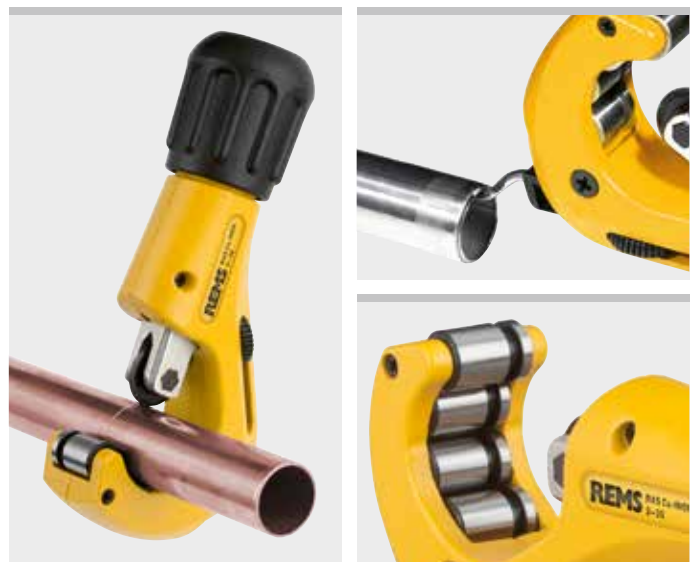

### Supply format

**REMS RAS Cu-INOX.** Pipe cutting machine for copper pipes, thin-walled stainless steel pipes, thin-walled steel-aluminium pipes, brass pipes, with integrated pipe deburring device. With cutter wheel. In blister pack.

Description	Pipes Ø mm/inch	Wall thickness s ≤ mm	Art.-No.	€
<b>Cu-INOX 3–35</b>	3–35 1/8–1 3/8"	4	113350R	<b>61,14</b>
<b>Cu-INOX 3–35 S</b> on needle bearings	3–35 1/8–1 3/8"	4	113351R	<b>81,90</b>
<b>Cu-INOX 3–42</b>	3–42 1/8–1 3/4"	4	113330R	<b>76,71</b>



### REMS RAS Cu-INOX – quality pipe cutter.

Robust, solid design for heavy-duty application.

Sturdy spindle, long spindle guidance and hardened back pressure rollers provide exact alignment to the tube, easy in-feed, easy cutting and precise, right angle cut.

Ergonomic, handy operating knob in metal for easy work and long service life.

Specially hardened cutter wheel in approved, tough-hard REMS die-steel quality ensures a long service life.

Cutter wheel protected against touching the back pressure rollers by in-feed limitation.

REMS RAS Cu-INOX 8–64 S and REMS RAS Cu-INOX 8–42 S with needle bearing cutting wheel and needle bearing counter-pressure rollers for very easy cutting. Quick adjustment of the engagement spindle in both directions.

Only 1 cutter wheel for the complete working capacity  $\varnothing$  3–120 mm.



Info

### Supply format

**REMS RAS Cu-INOX.** Pipe cutter for copper tubes, thin-walled stainless steel tubes, thin-walled steel, aluminium, brass tubes. With cutter wheel. In blister pack/in box.

Description	Pipes $\varnothing$ mm/inch	Wall thickness s ≤ mm	Art.-No.	€
<b>Cu-INOX 3–28</b>	3–28 1/8–1 1/8"	4	113300R	<b>33,63</b>
<b>Cu-INOX 6–42</b>	6–42 1/4–1 5/8"	4	113380R	<b>158,81</b>
<b>Cu-INOX 8–42 S</b> on needle bearings, with quick adjustment	8–42 3/8–1 5/8"	4	113385R	<b>163,49</b>
<b>Cu-INOX 6–64</b>	6–64 1/4–2 1/2"	4	113400R	<b>185,80</b>
<b>Cu-INOX 8–64 S</b> on needle bearings, with quick adjustment	8–64 3/8–2 1/2"	4	113401R	<b>206,56</b>
<b>Cu-INOX 64–120</b>	64–120 2 1/2–4"	4	113500R	<b>268,84</b>

### Accessories

Description	Wall thick- ness s ≤ mm	Art.-No.	€
<b>REMS cutter wheel Cu-INOX 3–120, s 4</b>	4	113210R	<b>12,04</b>
<b>REMS cutter wheel Cu-INOX 3–120 S, s 4, on needle bearings</b>	4	113213R	<b>21,07</b>
<b>Universal deburring blade, ground</b>		113360	<b>7,89</b>



German Quality Products



Robust quality tools for cutting tubes.

Copper tubes Ø 3 – 64 mm  
Ø 1/8 – 2 1/2"

### REMS RAS Cu – for places with difficult access.

Small, handy, specially for use in restricted spaces.

Robust design and hardened back pressure rollers provide exact alignment to the tube and a long service life.

Large operating knob in metal for easy in-feed and cutting.

Broad, precise cutter wheel bearing on a hardened, non rotating wheel shaft guarantees a right angle cut.

Specially hardened cutter wheel in approved, tough-hard REMS die-steel quality ensures a long service life. Fast changing of cutter wheel without tools by cutter wheel axle with ball catch. Cutter wheel protected against touching the back pressure rollers by in-feed limitation.



### Supply format

REMS RAS Cu. Pipe cutter for copper tubes. With cutter wheel. In blister pack.

Description	Pipes Ø mm/inch	Wall thickness s ≤ mm	Art.-No.	€
<b>Cu 3 – 16</b>	3 – 16 1/8 – 5/8"	3	113250R	<b>28,55</b>
<b>Cu 3 – 25</b>	3 – 25 1/8 – 1"	3	113255R	<b>34,57</b>
<b>Cu 3 – 28</b>	3 – 28 1/8 – 1 1/8"	3	113260R	<b>39,55</b>

### REMS RAS Cu – the compact version with telescopic spindle.

Telescopic spindle. Easy, quick adjustment in both directions.

Compact design for tough use.

Sturdy telescopic spindle, long spindle guidance and 4 specially hardened back pressure rollers ensure exact alignment to the tube, easy in-feed, easy cutting and precise, right angle cut.

Ergonomic, handy operating knob in metal for easy work and long service life.

Specially hardened cutter wheel in approved, tough-hard REMS die-steel quality ensures a long service life. Fast changing of cutter wheel without tools by cutter wheel axle with ball catch. Cutter wheel protected against touching the back pressure rollers by in-feed limitation.

Integrated pipe deburring device, on rotating bearing, adapts to the workpiece edge to be deburred.

Specially hardened and ground universal deburring blade guarantees easy deburring and extremely long life.

Fast, simple blade change.

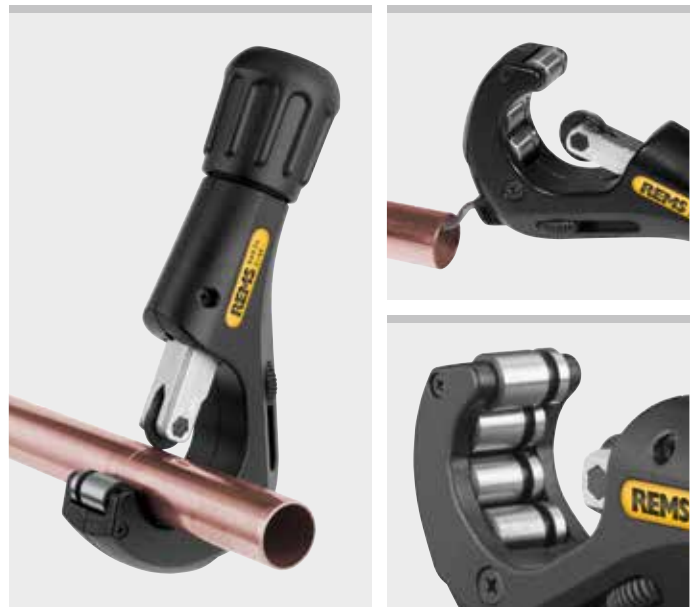

### Supply format

REMS RAS Cu. Pipe cutter for copper tubes, with integrated pipe deburring device. With cutter wheel. In blister pack.

Description	Pipes Ø mm/inch	Wall thickness s ≤ mm	Art.-No.	€
<b>Cu 3 – 35</b>	3 – 35 1/8 – 1 3/8"	3	113340R	<b>58,02</b>
<b>Cu 3 – 42</b>	3 – 42 1/8 – 1 3/4"	3	113320R	<b>69,65</b>



# REMS RAS Cu

## Pipe cutters

### REMS RAS Cu – quality pipe cutter. With quick adjustment.

Solid, handy, U-shaped design.

Sturdy spindle, long spindle guidance and hardened back pressure rollers provide exact alignment to the pipe, easy in-feed, easy cutting and precise, right angle cut.

Ergonomic, handy operating knob in metal for easy work and long service life.

Ratchet for quick adjustment in both directions.

Specially hardened cutter wheel in approved, tough-hard REMS die-steel quality ensures a long service life.

Cutter wheel protected against touching the back pressure rollers by in-feed limitation.

Only 1 cutter wheel for the complete working capacity  $\varnothing$  3 – 120 mm.

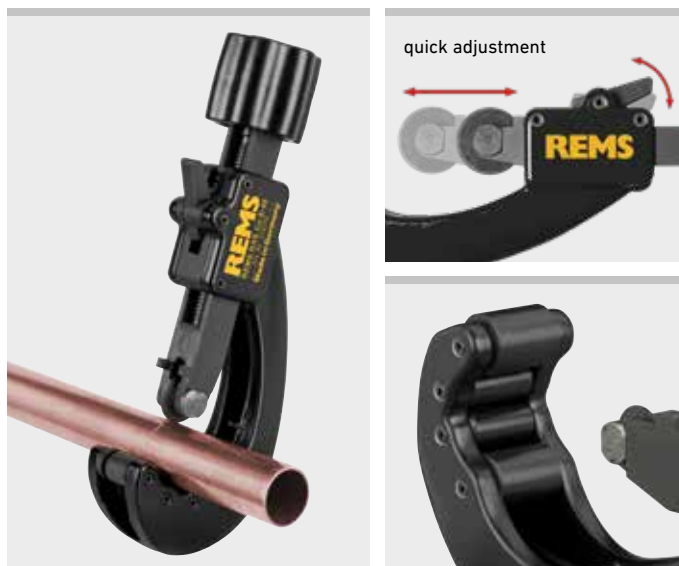

German Quality Products

International  
Design Award



#### Supply format

REMS RAS Cu. Pipe cutter for copper tubes. With cutter wheel.  
In blister pack/in box.

Description	Pipes $\varnothing$ mm/inch	Wall thickness s $\leq$ mm	Art.-No.	€
<b>Cu 8–42</b> with quick adjustment	8–42 $\frac{3}{8}$ –1 $\frac{1}{2}$ "	3	113370R	<b>154,66</b>
<b>Cu 8–64</b> with quick adjustment	8–64 $\frac{3}{8}$ –2 $\frac{1}{2}$ "	3	113410R	<b>185,80</b>

#### Accessories

Description	Wall thick- ness s $\leq$ mm	Art.-No.	€
<b>REMS cutter wheel Cu 3–120, s 3</b>	3	113225R	<b>12,04</b>
<b>Universal deburring blade, ground</b>		113360	<b>7,89</b>



# REMS RAS P

## Pipe cutters

### REMS RAS P – the compact version with telescopic spindle.

Telescopic spindle. Easy, quick adjustment in both directions.

Compact design for tough use.

Sturdy telescopic spindle, long spindle guidance and 4 specially hardened back pressure rollers ensure exact alignment to the tube, easy in-feed, easy cutting and precise, right angle cut.

Ergonomic, handy operating knob in metal for easy work and long service life.

Specially hardened cutter wheel in approved, tough-hard REMS die-steel quality ensures a long service life. Fast changing of cutter wheel without tools by cutter wheel axle with ball catch. Cutter wheel protected against touching the back pressure rollers by in-feed limitation.

Integrated pipe deburring device, on rotating bearing, adapts to the workpiece edge to be deburred.

Specially hardened and ground universal deburring blade guarantees easy deburring and extremely long life.

Fast, simple blade change.



#### Supply format

REMS RAS P. Pipe cutter for plastic pipes and multi-layer composite tubess,  
with integrated pipe deburring device. With cutter wheel. In blister pack.

Description	Pipes $\varnothing$ mm/inch	Wall thickness s $\leq$ mm	Art.-No.	€
<b>P 10–32 T</b>	10–32 $\frac{1}{2}$ –1 $\frac{3}{8}$ "	4,5	290001R	<b>58,02</b>
<b>P 10–40 T</b>	10–40 $\frac{1}{2}$ –1 $\frac{5}{8}$ "	4,5	290002R	<b>69,65</b>

High performance quality tools for cutting pipes.  
With quick adjustment.

Plastic pipes,  
multi-layer composite tubes Ø 10–315 mm  
Ø ½–12"

### REMS RAS P – quality pipe cutter. With quick adjustment.

Solid, handy, U-shaped design.

Sturdy spindle, long spindle guidance and hardened back pressure rollers provide exact alignment to the pipe, easy in-feed, easy cutting and precise, right angle cut.

Ergonomic, handy operating knob in metal for easy work and long service life.

Ratchet for quick adjustment in both directions.

Specially hardened cutter wheel in approved, tough-hard REMS die-steel quality ensures a long service life.

Cutter wheel protected against touching the back pressure rollers by in-feed limitation.

Cutter wheels for different wall thicknesses (s).

REMS RAS P 50–125 with integrated pipe deburrer, on rotating bearing, adapts to the workpiece edge to be deburred. Specially hardened and ground universal deburring blade guarantees easy deburring and extremely long life. Fast, simple blade change. Additional guide roller, adjustable, for cutting Ø 110 mm or Ø 125 mm pipes. Fast cutting wheel change without tools by cutting wheel axle with ball catch.



\*German Quality Products



P 50–110, s11  
P 50–110, s16  
P 50–110, s19



### Supply format

REMS RAS P. Pipe cutter for plastic pipes and multi-layer composite tubes.  
With cutter wheel. In blister pack/in box.

Description	Pipes Ø mm/inch	Wall thickness s ≤ mm	Art.-No.	€
<b>P 10–40*</b> with quick adjustment	10–40 ½–1½"	7	290050R	<b>154,66</b>
<b>P 10–63*</b> with quick adjustment	10–63 ½–2"	7	290000R	<b>196,18</b>
<b>P 50–110*, s11</b> with quick adjustment	50–110 2–4"	11	290100R	<b>234,59</b>
<b>P 50–110*, s16</b> with quick adjustment	50–110 2–4"	16	290100R	<b>234,59</b>
<b>P 50–110*, s19</b> with quick adjustment	50–90 2–3"	19	290100R	<b>234,59</b>
<b>P 50–125, s16</b> with quick adjustment	50–125 2–5"	16	290500R-S16	<b>241,85</b>
<b>P 110–160*</b> with quick adjustment	110–160 4–6"	16	290200R	<b>289,60</b>

### REMS RAS P – cutting up to Ø 315 mm, s ≤ 19 mm.

Fast and inexpensive cutting of large pipes. Quick adjustment.  
Separate pipe centering for right angle cutting.

Solid design, double-T-shaped body.

Cutter wheels for different wall thicknesses (s).

### Supply format

REMS RAS P. Pipe cutter for plastic pipes and multi-layer composite tubes.  
With cutter wheel and spare cutter wheel. In sturdy steel case.

Description	Pipes Ø mm/inch	Wall thickness s ≤ mm	Art.-No.	€
<b>P 180–315</b> with quick adjustment	180–315 7–12"	16	290300	<b>1.717,89</b>

### Accessories

Description	s ≤ mm	Art.-No.	€
<b>REMS cutter wheel P 10–40, s 4,5</b> for REMS RAS P 10–32 T, 10–40 T	4,5	290023R	<b>19,51</b>
<b>REMS cutter wheel P 10–63, s 7</b> for REMS RAS P 10–40, 10–63	7	290016R	<b>19,51</b>
<b>REMS cutter wheel P 50–315, s 11</b> for REMS RAS P 50–110, 50–125, 110–160, 180–315	11	290116R	<b>23,67</b>
<b>REMS cutter wheel P 50–315, s 16</b> for REMS RAS P 50–110, 50–125, 110–160, 180–315	16	290216R	<b>28,23</b>
<b>REMS cutter wheel P 50–315, s 19</b> for REMS RAS P 50–110, 110–160, 180–315	19	290316R	<b>45,57</b>



# REMS RAS P/SW 45/L

Pipe cutter/pipe slitter

Robust quality tool with two cutting systems for cutting and slitting plastic corrugated protective pipes.

Cutting	$\varnothing \leq 45 \text{ mm}$ $\varnothing \leq 1\frac{3}{4}''$
Slitting (lengthwise cutting)	ID $\geq \varnothing 14 \text{ mm}$

## REMS RAS P/SW 45/L – Cutting and slitting of plastic corrugated protective pipes.

Stable magnesium version, extremely light.

Specially hardened and specially ground blades for cutting and slitting. German quality product.

Four-edged, wedge-shaped blades with a cutting angle of 90°, rotatable 4 times by 90° for four times longer life. Right-angled, burr-free cutting by pipe rest with shaft guide.

Automatic contact pressure when cutting.

Cutting depth limiting of the cutting tools during cutting prevents damage to the inside of the pipe.



Info

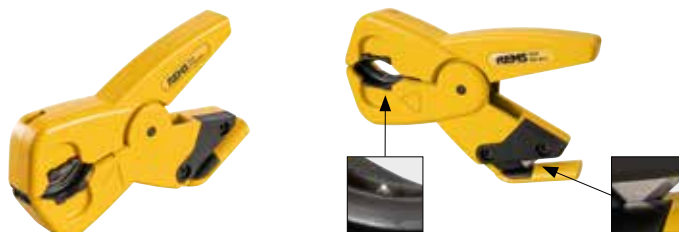

### Supply format

**REMS RAS P/SW 45/L.** Pipe cutter/pipe slitter for plastic corrugated protective pipes. With 3 blades. In blister pack.

Pipes $\varnothing$ mm/inch	Art.-No.	€
$\leq 45 \text{ mm} / \leq 1\frac{3}{4}''$	113480R	<b>56,99</b>

### Accessories

Description	Art.-No.	€
<b>Blade P/SW 45/L (pack of 3)</b> for REMS RAS P/SW 45/L	113481R	<b>28,49</b>



# REMS RAS W INOX

Pipe cutter

Highly resistant quality tool for cutting pipes.

Corrugated metal hoses (corrugated pipes) of stainless steel, also jacketed  
DN 10 – 32 (40)  
 $\frac{3}{8} - 1\frac{1}{2}'' (2'')$

## REMS RAS W INOX 10 – 32/40 S – Quality pipe cutter especially for cutting corrugated metal hoses (corrugated pipes) made of stainless steel.

Compact design for tough use.

Easy in-feed, easy cutting and precise, right angle cut.

Sturdy telescopic spindle, long spindle guide, cutting wheel on needle bearing and 2 specially hardened counter pressure rollers on needle bearings. Three high-molecular plastic guide rollers each on both sides, arranged triangularly for straight guidance of the corrugated metal hose (corrugated pipe) during the cutting process.

Ergonomically designed, comfortable rotary handle.

Specially hardened cutter wheel in approved, tough-hard REMS die-steel quality ensures a long service life. Cutter wheel protected against touching the back pressure rollers by in-feed limitation.



e.g.  
Armaflex,  
BANIDES,  
Boagaz,  
Chuchu Decayeux,  
Clesse,  
Eurotis,  
FlexiPipe,  
Gastite,  
Gurtner

German Quality Products



Info



### Supply format

**REMS RAS W INOX 10 – 32/40 S.** Pipe cutter for corrugated metal hoses (corrugated pipes) of stainless steel, also jacketed. Counter pressure rollers on needle bearings. With cutting wheel, on needle bearing. In blister pack.

Pipes	Art.-No.	€
DN 10 – 32 (40) / $\frac{3}{8} - 1\frac{1}{2}'' (2'')$	113450R	<b>216,94</b>

### Accessories

Description	Art.-No.	€
<b>REMS cutter wheel W INOX 10 – 32/40 S</b> on needle bearings	113461R	<b>11,83</b>





# REMS cutter wheels

German Quality Products  
For REMS pipe cutters and other makes

Specially hardened cutter wheels in approved, tough-hard REMS die steel, ensure a long service life. German Quality Products.

REMS cutter wheels also fit in suitable pipe cutters of other makes, see table with dimensional data.

REMS cutter wheel	Material	Wall thickness	to fit following pipe cutters	Capacity Ø	Art.-No.	€
St ½-4", s 8	Steel pipes	s ≤ 8 mm	REMS RAS St ½-2" REMS RAS St 1¼-4"	½-2" 1¼-4"	341614 R	15,47
St 1-4", s 12	Steel pipes	s ≤ 12.5 mm	REMS RAS St 1¼-4"	1¼-4"	381622 R	35,60
Cu-INOX 3-120, s 4	Copper tubes, stainless steel tubes	s ≤ 4 mm	REMS RAS Cu-INOX 3-16 REMS RAS Cu-INOX 3-28 REMS RAS Cu-INOX 3-35 REMS RAS Cu-INOX 3-42 REMS RAS Cu-INOX 6-42 REMS RAS Cu-INOX 6-64 REMS RAS Cu-INOX 64-120 REMS RAS Cu 3-35 REMS RAS Cu 3-42	3-16 mm 3-28 mm 3-35 mm 3-42 mm 6-42 mm 6-64 mm 64-120 mm 3-35 mm 3-42 mm	113210 R	12,04
Cu-INOX 3-120 S, s 4, on needle bearings	Copper tubes, stainless steel tubes	s ≤ 4 mm	REMS RAS Cu-INOX 3-28 S REMS RAS Cu-INOX 3-35 S REMS RAS Cu-INOX 8-42 S REMS RAS Cu-INOX 8-64 S	3-28 mm 3-35 mm 8-42 mm 8-64 mm	113213 R	21,07
Cu-INOX b 3, s 4	Copper tubes, stainless steel tubes	s ≤ 4 mm	See table "Dimensional data for REMS cutter wheels"		113220 R	12,04
Cu 3-120, s 3	Copper tubes	s ≤ 3 mm	REMS RAS Cu-INOX 3-16 REMS RAS Cu-INOX 3-25 REMS RAS Cu-INOX 3-28 REMS RAS Cu-INOX 3-35 REMS RAS Cu-INOX 3-42 REMS RAS Cu-INOX 6-42 REMS RAS Cu-INOX 6-64 REMS RAS Cu-INOX 64-120 REMS RAS Cu 3-16 REMS RAS Cu 3-25 REMS RAS Cu 3-28 REMS RAS Cu 3-35 REMS RAS Cu 3-42 REMS RAS Cu 8-42 REMS RAS Cu 8-64	3-16 mm 3-25 mm 3-28 mm 3-35 mm 3-42 mm 6-42 mm 6-64 mm 64-120 mm 3-16 mm 3-25 mm 3-28 mm 3-35 mm 3-42 mm 8-42 mm 8-64 mm	113225 R	12,04
P 10-40, s 4,5	Plastic pipes, composite tubes	s ≤ 4,5 mm	REMS RAS P 10-32 T REMS RAS P 10-40 T	10-32 mm 10-40 mm	290023 R	19,51
P 10-63, s 7	Plastic pipes, composite tubes	s ≤ 7 mm	REMS RAS P 10-40 REMS RAS P 10-63	10-40 mm 10-63 mm	290016 R	19,51
P 50-315, s 11	Plastic pipes, composite tubes	s ≤ 11 mm	REMS RAS P 50-110 REMS RAS P 50-125 REMS RAS P 110-160 REMS RAS P 180-315	50-110 mm 50-125 mm 110-160 mm 180-315 mm	290116 R	23,67
P 50-315, s 16	Plastic pipes, composite tubes	s ≤ 16 mm	REMS RAS P 50-110 REMS RAS P 50-125 REMS RAS P 110-160 REMS RAS P 180-315	50-110 mm 50-125 mm 110-160 mm 180-315 mm	290216 R	28,23
P 50-315, s 19	Plastic pipes, composite tubes	s ≤ 19 mm	REMS RAS P 50-110 REMS RAS P 50-125 REMS RAS P 110-160 REMS RAS P 180-315	50-110 mm 50-125 mm 110-160 mm 180-315 mm	290316 R	45,57
W INOX 10-32/40 S, on needle bearings	Corrugated metal hoses (corrugated pipes) of stainless steel		REMS RAS W INOX 10-32/40 S	DN 10-32 (40)	113461 R	11,83

Dimensional data for REMS cutter wheels

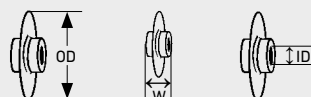

REMS cutter wheel	Art.-No.	OD mm	W mm	ID mm
St ½-4", s 8	341614 R	32.30	18.94	9.04
St 1-4", s 12	381622 R	41.30	18.94	9.04
Cu-INOX 3-120, s 4	113210 R	19.70	4.93	5.00
Cu-INOX 3-120 S, s 4	113213 R	19.70	4.93	5.00
Cu-INOX b 3, s 4	113220 R	18.70	3.07	4.80
Cu 3-120, s 3	113225 R	18.70	4.93	5.00
P 10-40, s 4,5	290023 R	20.50	4.93	5.00
P 10-63, s 7	290016 R	25.20	5.97	6.00
P 50-315, s 11	290116 R	35.30	10.95	8.00
P 50-315, s 16	290216 R	45.30	10.95	8.00
P 50-315, s 19	290316 R	51.30	10.95	8.00
W INOX 10-32/40 S	113461 R	26.60	4.93	5.00

German Quality Products

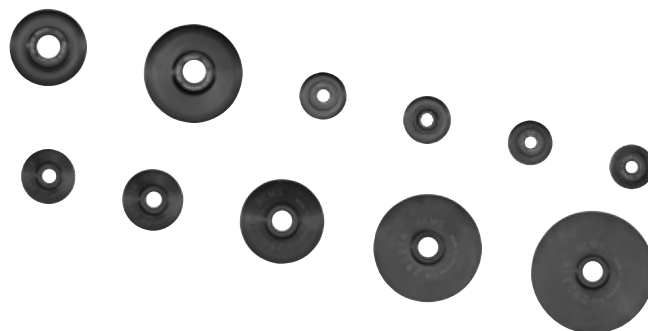

Powerful, handy electric tool for cutting pipe and tubing. For trade and industry. For the building site and the workshop.

Stainless steel pipes of pressfitting systems, carbon steel, copper	Ø 12 – 28 mm Ø 10 – 35 mm
Multilayer composite pipes	Ø 10 – 40 mm

**REMS Nano – cutting up to Ø 40 mm. Ultra-light. Fast. Right angled. Chip-free. Without outer burr. Dry.**

### Ideal for pressfitting systems

**Right angled cutting**, according to requirements

**Chip-free**, no chips in piping system

**No outer burr**, no damage to O-ring by outer burr

**Dry cutting**, no damage to O-rings from lubricants

**Fast**, prevents degradation of pipe material through overheating.

### Design

Mobile, electric pipe cutting machine for fast, right angled cutting without outer burr. Handy and light, only 1.9 kg. Also for fixing to the workbench or in the vice. Strong, torsion-free aluminium structure for right angled cutting. Easy cutting of the pipes by specially designed cutter wheel. Powered cutter wheel for fast cutting. Energy-saving in-feed due to ergonomically designed pressing lever. Cutter wheel protected against touching the back pressure rollers by in-feed limitation.

### Pipe support

3 sturdy, specially arranged counter-pressure rollers made of hardened precision steel for low-friction turning and safe guidance of the pipes to be cut in the whole working range Ø 10 – 40 mm and for optimisation of the contact points of the cutting wheel on the pipe to be cut (**Patent EP 2 077 175**). No setting.

### Drive

Robust gear precisely mounted in ball and needle bearings, maintenance-free. Proven DC motor 230 V, 130 W. Powerful. e.g. copper pipe Ø 22 mm in only 3 s. Ideal speed 130 rpm for optimum cutting speed of the pipes. Safety switch.

### REMS cutter wheels

Top German quality. Cutter wheels specially designed to the performance capability of the REMS Nano and for numerous pipe materials with variable cutting geometries for fast cutting with no outer burr. Specially hardened, from proven, through-hardened REMS die-steel, ensuring long service life.



German Quality Product



### Supply format

**REMS Nano Basic-Pack.** Electric pipe cutting machine for fast, right angled cutting of pipes Ø 10 – 40 mm, without outer burr. For pipes of the press fitting systems made of stainless steel, carbon steel, Ø 12 – 28 mm, copper Ø 10 – 35 mm. Multilayer composite tubes Ø 10 – 40 mm. With maintenance-free gear, proven DC motor 130 V, 50 – 60 Hz, 200 W. Speed 130 rpm. Back pressure rollers made of hardened precision steel. Safety switch. Single open ended wrench size 8. Without cutter wheel. In carrying bag.

	Art.-No.	€
	844010R220	529,38



### Accessories

Description	Art.-No.	€
<b>REMS cutter wheel Cu-INOX</b> for stainless steel pipes of pressfitting systems, copper, carbon steel	844050R	38,20
<b>REMS cutter wheel V</b> for multilayer composite pipes	844051R	38,20
<b>Carrying bag</b>	574436R	38,41
<b>L-Boxx system case</b> with inlay for REMS Nano/ Nano 12V, rapid charger, battery, REMS REG 8 – 35, 2 x REMS cutter wheels, metre rule	844045R	146,36
<b>REMS Jumbo</b> , folding workbenches, see page 106.		
<b>REMS Herkules</b> , material supports, see page 107.		

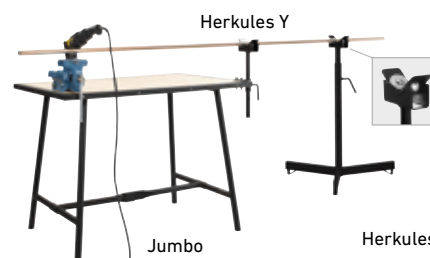

# REMS Nano 12V

Cordless pipe cutter

Powerful, mobile, handy electric tool for cutting pipe and tubing. For trade and industry. For the building site and the workshop.

Stainless steel pipes of pressfitting systems, carbon steel, copper	Ø 12–28 mm Ø 10–35 mm
Multilayer composite pipes	Ø 10–40 mm

**REMS Nano 12V – cutting up to Ø 40 mm. Mobile, handy, ultra-light. Fast. Right angled. Chip-free. Without outer burr. Dry.**

### Ideal for pressfitting systems

**Right angled cutting**, according to requirements

**Chip-free**, no chips in piping system

**No outer burr**, no damage to O-ring by outer burr

**Dry cutting**, no damage to O-rings from lubricants

**Fast**, prevents degradation of pipe material through overheating.

### Design

Mobile, battery-powered pipe cutting machine for fast, right angled cutting without outer burr. Handy and light, only 2.1 kg. Also for fixing to the workbench or in the vice. Strong, torsion-free aluminium structure for right angled cutting. Easy cutting of the pipes by specially designed cutter wheel. Powered cutter wheel for fast cutting. Energy-saving in-feed due to ergonomically designed pressing lever. Cutter wheel protected against touching the back pressure rollers by in-feed limitation.

### Pipe support

3 sturdy, specially arranged counter-pressure rollers made of hardened precision steel for low-friction turning and safe guidance of the pipes to be cut in the whole working range Ø 10–40 mm and for optimisation of the contact points of the cutting wheel on the pipe to be cut (**Patent EP 2 077 175**). No setting.

### Drive

Robust, precision ball and needle bearing gears, maintenance-free. Powerful battery motor 12V, with large power reserve, 270 W output. Super fast, e.g. copper pipe Ø 22 mm in just 3 s. Ideal speed 130 rpm for optimum cutting speed of the pipes. Safety switch.

### Li-Ion technology

Battery Li-Ion 12V with 2.5 Ah capacity. Light and powerful. High energy density for many cuts. Overheating and overloading protection by temperature monitor (NTC). Rapid charger 220–240V, 10.8–18V, 65W, for short charging times. No memory effect for maximum battery performance.

### REMS cutter wheels

Top German quality. Cutter wheels specially designed to the performance capability of the REMS Nano 12V and for numerous pipe materials with variable cutting geometries for fast cutting with no outer burr. Specially hardened, from proven, through-hardened REMS die-steel, ensuring long service life.



German Quality Product



Info

### Supply format

**REMS Nano 12V Basic-Pack.** Electric pipe cutting machine for fast, right angled cutting of pipes Ø 10–40 mm, without outer burr. For pipes of the press fitting systems made of stainless steel, carbon steel, Ø 12–28 mm, copper Ø 10–35 mm. Multilayer composite tubes Ø 10–40 mm. With maintenance-free gear, powerful battery motor 12V, 270 W. Speed 130 rpm. Safety switch. Battery Li-Ion 12V, 2.5 Ah, rapid charger 220–240V, 50–60 Hz, 10.8–18V, 65W. Counter pressures rollers made of hardened precision steel. Single open ended wrench size 8. Without cutting wheel. In carrying bag.

	Art.-No.	€
	844011R220	705,84

### Accessories

Description	Art.-No.	€
<b>REMS cutter wheel Cu-INOX</b> for stainless steel pipes of pressfitting systems, copper, carbon steel	844050R	38,20
<b>REMS cutter wheel V</b> for multilayer composite pipes	844051R	38,20
<b>Battery Li-Ion 12V, 2.5 Ah</b>	844510R12	139,09
<b>Rapid charger 220–240V, 50–60 Hz, 10.8–18V, 65W</b>	571560R220	154,66
<b>Carrying bag</b>	574436R	38,41
<b>L-Boxx system case</b> with inlay for REMS Nano/ Nano 12V, rapid charger, battery, REMS REG 8–35, 2x REMS cutter wheels, metre rule	844045R	146,36
<b>REMS Jumbo</b> , folding workbenches, see page 106.		
<b>REMS Herkules</b> , material supports, see page 107.		



Light, portable compact machine. Universal for cutting and deburring pipes. For trade and industry. For the building site and the workshop.

Stainless steel pipes of pressfitting systems, carbon steel, copper	Ø 8 – 108 mm
Steel pipes EN 10255 (DIN 2440)	DN 6 – 100 Ø ½ – 4", Ø 10 – 115 mm
Cast iron pipes (SML) EN 877 (DIN 19522)	DN 50 – 100
Plastic pipes SDR 11	
Wall thickness $s \leq 10$ mm	Ø 10 – 110 mm Ø ½ – 4"
Multilayer composite pipes	Ø 10 – 110 mm
<b>REMS Cento RF Set</b>	
Welded drain pipe/down pipe made of stainless steel (EN 1124)	Ø 40 – 110 mm

**REMS Cento – Cutting and deburring up to Ø 115 mm. Super fast. Right angled. Chip-free. No outer burr. Dry cutting.**

**Universal for many pipe types.**

### Ideal for pressfitting systems

**Right angled cutting**, according to requirements

**Chip-free**, no chips in piping system

**No outer burr**, no damage to O-ring by outer burr

**Dry**, no damage to the O-ring by coolants-lubricants.

**Fast**, prevents degradation of pipe material through overheating.

### Design

Compact, mobile pipe cutting machine for fast, right angled, cutting with no outer burr. Handy and light, only 16.8 kg. Stable, distortion-free cast construction for right angled cutting. Easy pipe-cutting through specially designed cutter wheel. Powered cutter wheel and linear advance for fast cutting (**Patent EP 1 782 904**). Power saving feed-in through easy to grip, proven advance-lever and needle bearing mounted machine screw spindle. Cutter wheel protected – as movement restricted to before any contact with the rollers. Connection for driving outer/inner pipe deburrer REMS REG 10 – 54 E. For workbench, stand or wheel stand as an accessory, for easy transport, optimum working height and stable positioning. An alternative feed lever is available for operating the drive unit on the floor, see accessories.

### Running rollers

4 strong hardened precision tubular steel running rollers on ball bearings for low-friction turning of the pipes Ø 22 – 115 mm, Ø ¾ – 4" to be cut, trapezoidally arranged, replaceable. No setting work required in the whole working range Ø 22 – 115 mm. Stainless tubular steel rollers as accessory. Cutting of pipes Ø 8 – 22 mm by placing two pipe sections Ø 28 x 220 mm on the running rollers. REMS Cento RF with 4 sturdy polyamide rollers mounted on ball bearings, to avoid damage to the pipe surfaces, for low-friction rotation of the welded drain pipes/downpipes of stainless steel (EN 1124) Ø 40 – 110 mm to be cut; pipe guides Ø 75 and 110 mm prevent the pipe from becoming oval shaped.

### Drive

Robust gear, precisely mounted in roller and needle bearings, maintenance-free. Proven universal motor, 1200 W. Powerful, e.g. stainless steel pipe Ø 54 mm in just 4 s. Ideal speed 115 rpm for optimum cutting speed of the pipes. Safety foot-switch with emergency stop.

### REMS cutter wheels

Top German quality. Cutter wheels specially designed to the performance capability of the REMS Cento and for numerous pipe materials with variable cutting geometries for fast cutting with no outer burr. Specially hardened, from proven, through-hardened REMS die-steel, ensuring long service life.

### Pipe support

Pipe support, height adjustable, for pipes Ø 40 – 110 mm, Ø 1½ – 4", with operation of the drive unit with feed lever on the floor. Easy moving of the material in all directions when turning, pulling and pushing by four stainless steel balls mounted in a rust-protected housing. Safe guiding of long pipes by use of several pipe supports.

### REMS pipe deburrer

Inner pipe deburrer REMS REG 28 – 108 for pipes Ø 28 – 108 mm, Ø ¾ – 4", with circulating friction element on the deburrer housing (**Patent EP 2 500 122**) for electrical rotary drive by the cutting wheel of the REMS Cento, REMS Cento 22V pipe cutting machine, as an accessory. Outer/inner pipe deburrer REMS REG 10 – 54 E for pipes Ø 10 – 54 mm, Ø ½ – 2½", for electric drive with the REMS Cento, REMS Cento 22V pipe cutting machines, see page 99.

### Marking device

Marking device for marking the insertion depth for fittings on pipes, as an accessory.

Patent EP 1 782 904

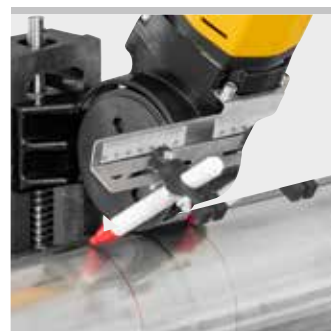
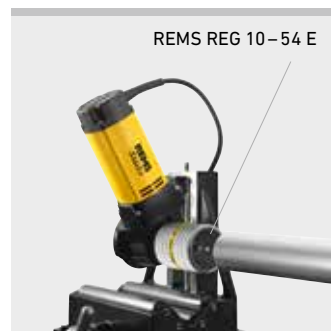

German Quality Product



Info

### Supply format

**REMS Cento Basic.** Pipe cutting machine for fast, right angled, cutting of pipes with no outer burr Ø 8–115 mm. For pipes of the press fitting systems made from stainless steel, carbon steel, copper, Ø 8–108 mm. For steel pipes EN 10255 (DIN 2440) DN 6–100, Ø ½–4", Ø 10–115 mm, cast pipes (SML) EN 877 (DIN 19522) DN 50–100, plastic tubes SDR 11, wall thickness  $s \leq 10$  mm, Ø 10–110 mm, Ø ½–4", composite tubes Ø 10–110 mm. With maintenance-free gear, proven universal motor 230 V or 110 V, 50–60 Hz, 1200 W. Speed 115 rpm. Rollers in hardened precision steel pipe for pipes Ø 22–115 mm, Ø ¾–4". Safety foot-switch. Ring spanner. Without cutter wheel. For workbench, stand or wheel stand. In a carton.

Art.-No.	€
845001R220	1.463,58

Other voltages on request.



### Supply format

**REMS Cento RF Set.** Pipe cutting machine especially for fast, right-angled cutting of welded drain pipes/down pipes made of stainless steel (EN 1124) Ø 40–110 mm. As Art. No. 845001, but with rollers made of polyamide and pipe guides Ø 75 and 110 mm. Safety foot switch. Ring spanner. With cutting wheel RF. For workbench, stand or wheel stand. In a carton.

Art.-No.	€
845003R220	2.324,08

Other voltages on request.



### Accessories

Description	Art.-No.	€
<b>Feed lever</b> with spring plug for operating the drive unit on the floor (for drive units manufactured from 2014 onwards).	845218R	91,66
<b>REMS cutter wheel Cu-INOX</b> for stainless steel pipes of pressfitting systems, copper, carbon steel	845050R	111,07
<b>REMS cutter wheel Cu</b> specially for pipes of copper pressfitting systems	845053R	111,07
<b>REMS cutter wheel St</b> for steel pipes, cast iron pipes (SML)	845052R	111,07
<b>REMS cutter wheel V</b> for plastic and multilayer composite pipes, wall thickness $s \leq 10$ mm	845051R	111,07
<b>REMS cutting wheel C-SF</b> especially for pipes of the pressfitting systems and push fitting systems made from carbon steel, simultaneously produces a chamfer.	845055R	111,07
<b>REMS cutting wheel RF</b> for cutting welded drain pipes/down pipes made of stainless steel (EN 1124) with REMS Cento RF.	845054R	111,07
<b>Pipe support 1</b> , height adjustable, for pipes Ø 40–110 mm, Ø ½–4", with operation of the drive unit with feed lever on the floor	845220R	152,59
<b>Hardened, precision tubular steel rollers (pack of 4)</b>	845118R	214,87
<b>Stainless tubular steel INOX rollers (pack of 4)</b>	845110RINOX	303,10
<b>Polyamide roller (pack of 4)</b>	845131RPA	355,00
<b>Marking device</b> for marking the insertion depth for fittings on pipes. For REMS Cento, REMS Cento 22V.	845530R	129,75
<b>REMS REG 10–54 E</b> , outer/inner pipe deburrer, see page 99		
<b>REMS REG 28–108</b> , inner pipe deburrer for pipes Ø 28–108 mm, Ø ¾–4", for electric rotary drive by the cutting wheel of the REMS Cento, REMS Cento 22V pipe cutting machine (with REMS cutting wheel Art. No. 845050 or 845053).	113840R	333,20
<b>Stand</b>	849315R	216,94
<b>Wheel stand</b>	849310R	351,88
<b>REMS Jumbo</b> , folding workbenches, see page 106.		
<b>REMS Herkules</b> , material supports, see page 107.		
<b>L-Boxx H system case</b> for REMS Cento/Cento RF	845085R	142,73

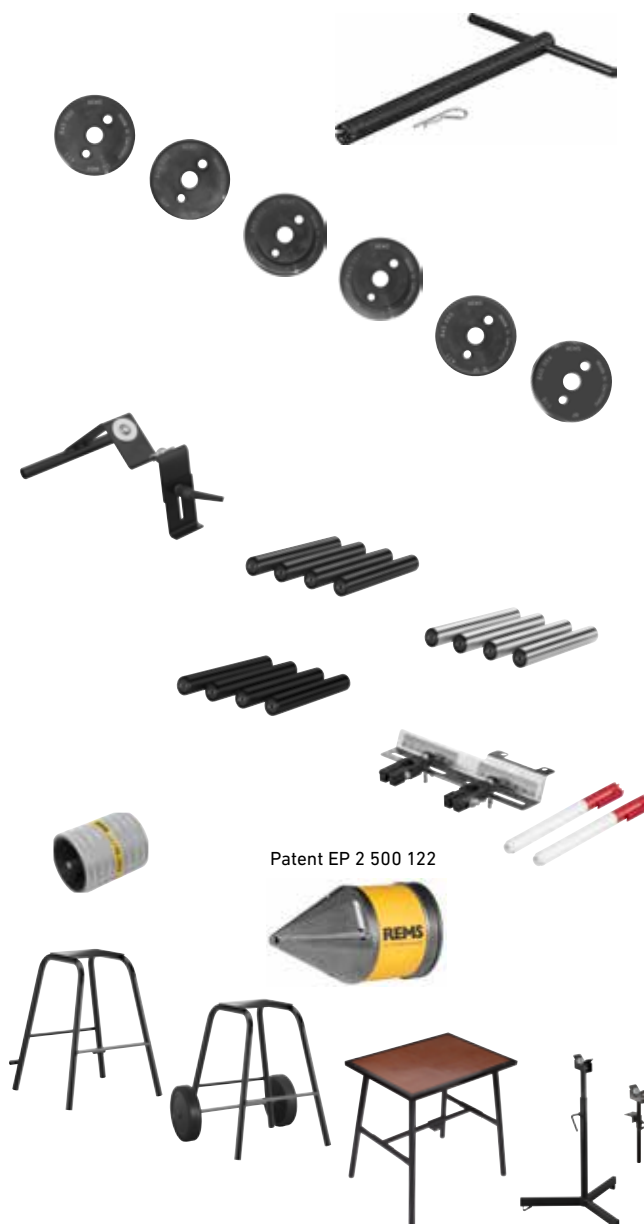

Patent EP 2 500 122

# REMS Cento 22V

Cordless pipe cutting machine

Light, mobile compact machine. Universal for cutting and deburring pipes. For trade and industry. For the building site and the workshop. Li-Ion 22V Technology. For battery and corded operation.

Stainless steel pipes of pressfitting systems, carbon steel, copper	Ø 8–108 mm
Steel pipes EN 10255 (DIN 2440)	DN 6–100 Ø 1/8–4", Ø 10–115 mm
Cast iron pipes (SML) EN 877 (DIN 19522)	DN 50–100
Plastic pipes SDR 11	
Wall thickness $s \leq 10$ mm	Ø 10–110 mm Ø 1/8–4"
Multilayer composite pipes	Ø 10–110 mm

**REMS Cento 22V – Mobile cutting and deburring up to Ø 115 mm. Super fast. Right angled. Chip-free. No outer burr. Dry cutting. Li-Ion 22V Technology. Li-Ion 21.6V, 5.0 Ah battery, for approx. 280 stainless steel pipe sections of the Ø 22 mm press fitting systems with one battery charge\*.**

**Universal for many pipe types.**

## Ideal for pressfitting systems

- Right angled cutting**, according to requirements
- Chip-free**, no chips in piping system
- No outer burr**, no damage to O-ring by outer burr
- Dry**, no damage to the O-ring by coolants-lubricants.
- Fast**, prevents degradation of pipe material through overheating.

## Design

Compact, mobile cordless pipe cutting machine for fast, right angled, cutting with no outer burr. Handy and light, drive unit with battery only 17.6 kg. Stable, distortion-free cast construction for right angled cutting. Easy pipe-cutting through specially designed cutter wheel. Powered cutter wheel and linear advance for fast cutting (Patent EP 1 782 904). Power saving feed-in through easy to grip, proven advance-lever and needle bearing mounted machine screw spindle. Cutter wheel protected – as movement restricted to before any contact with the rollers. Practical handle for easy transport. Connection for driving outer/inner pipe deburrer REMS REG 10–54 E. For workbench, stand or wheel stand as an accessory, for easy transport, optimum working height and stable positioning. An alternative feed lever is available for operating the drive unit on the floor, see accessories.

## Running rollers

4 strong hardened precision tubular steel running rollers on ball bearings for low-friction turning of the pipes Ø 22–115 mm, Ø 3/4–4" to be cut, trapezoidally arranged, replaceable. No setting work required in the whole working range Ø 22–115 mm. Stainless tubular steel rollers as accessory. Cutting of pipes Ø 8–22 mm by placing two pipe sections Ø 28 x 220 mm on the running rollers.

## Drive

Robust gear, precisely mounted in roller and needle bearings, maintenance-free. Powerful 21.6 V battery motor, e.g. stainless steel pipe Ø 54 mm in just 7 s. Ideal speed 84 rpm for optimum cutting speed of the pipes. Machine status check with overload protection of the drive unit against too high currents, with overheating protection by motor temperature monitoring (NTC), with electronic battery charging status check with charging level indication by a 2-coloured green/red LED. Safety foot-switch with emergency stop.

## Battery or mains operation

Li-Ion 22V Technology. Highly resistant Li-Ion 21.6V battery with 4.4, 5.0 or 9.0 Ah capacity, for long service life. Light and powerful. Li-Ion 21.6V, 4.4Ah battery for approx. 246 stainless steel pipe sections, 5.0Ah battery for approx. 280 stainless steel pipe sections, 9.0Ah for approx. 520 stainless steel pipe sections of the Ø 22mm press fitting systems with one battery charge\*. Graduated charging status check by coloured LEDs. Operating temperature range – 10 to + 60 °C. No memory effect for maximum battery power. Rapid charger 100–240V, 90W. Rapid charger 100–240V, 290W, for shorter charging times, as accessory. Voltage supply 220–240V/21.6V, 40A output, for mains operation instead of Li-Ion battery 21.6 V, as accessory.

## REMS cutter wheels

Top German quality. Cutter wheels specially designed to the performance capability of the REMS Cento 22V and for numerous pipe materials with variable cutting geometries for fast cutting with no outer burr. Specially hardened, from proven, through-hardened REMS die-steel, ensuring long service life.

## Pipe support

Pipe support, height adjustable, for pipes Ø 40–110 mm, Ø 1 1/2–4", with operation of the drive unit with feed lever on the floor. Easy moving of the material in all directions when turning, pulling and pushing by four stainless steel balls mounted in a rust-protected housing. Safe guiding of long pipes by use of several pipe supports.

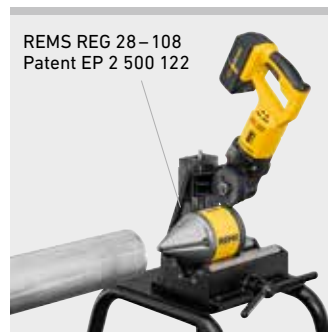
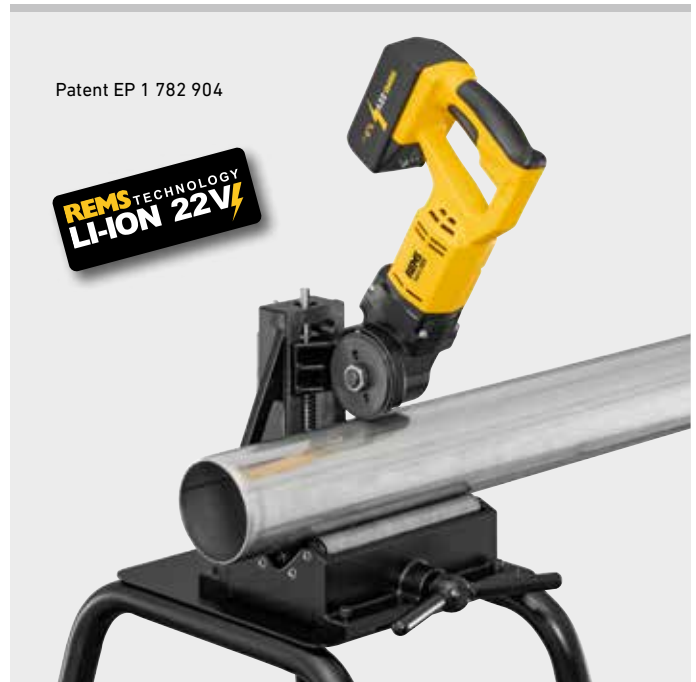

German Quality Product



Info

### REMS pipe deburrer

Inner pipe deburrer REMS REG 28–108 for pipes  $\varnothing$  28–108 mm,  $\varnothing$   $\frac{3}{4}$ –4", with circulating friction element on the deburrer housing (**Patent EP 2 500 122**) for electrical rotary drive by the cutting wheel of the REMS Cento, REMS Cento 22V pipe cutting machine, as an accessory. Outer/inner pipe deburrer REMS REG 10–54 E for pipes  $\varnothing$  10–54 mm,  $\varnothing$   $\frac{1}{2}$ –2 $\frac{1}{8}$ ", for electric drive with the REMS Cento, REMS Cento 22V pipe cutting machines, see page 99.

### Marking device

Marking device for marking the insertion depth for fittings on pipes, as an accessory.

### Supply format

**REMS Cento 22V Basic.** Cordless pipe cutting machine for fast, right angled, cutting of pipes with no outer burr  $\varnothing$  8–115 mm. For pipes of the press fitting systems made from stainless steel, carbon steel, copper,  $\varnothing$  8–108 mm. For steel pipes EN 10255 (DIN 2440) DN 6–100,  $\varnothing$   $\frac{1}{8}$ –4",  $\varnothing$  10–115 mm, cast pipes (SML) EN 877 (DIN 19522) DN 50–100, plastic tubes SDR 11, wall thickness  $s \leq 10$  mm,  $\varnothing$  10–110 mm,  $\varnothing$   $\frac{1}{8}$ –4", composite tubes  $\varnothing$  10–110 mm. With maintenance-free gear, powerful 21.6 V battery motor. Speed 84 rpm. Machine status check with overload protection, temperature monitoring, battery charging status check. Rollers in hardened precision steel pipe for pipes  $\varnothing$  22–115 mm,  $\varnothing$   $\frac{3}{4}$ –4". Safety foot-switch. Li-Ion 21.6V, 5.0Ah battery, 100–240V, 50–60 Hz, 90W rapid charger. Ring spanner. Without cutter wheel. For workbench, stand or wheel stand. In a carton.

	Art.-No.	€
	845002R220	2.055,24

Other voltages on request.

### Accessories

Description	Art.-No.	€
<b>Battery Li-Ion 21.6V, 4.4 Ah</b>	571574R22	372,64
<b>Battery Li-Ion 21.6V, 5.0 Ah</b>	571581R22	310,36
<b>Battery Li-Ion 21.6V, 9.0 Ah</b>	571583R22	414,16
<b>Rapid charger 100–240V, 50–60 Hz, 90W</b>	571585R220	175,42
<b>Rapid charger 100–240V, 50–60 Hz, 290W</b>	571587R220	414,16
<b>Voltage supply 220–240V/21.6V, 50–60 Hz, 40 A,</b> for mains operation instead of battery Li-Ion 21.6V	571578R220	517,96
<b>Feed lever</b> with spring plug for operating the drive unit on the floor.	845218R	91,66
<b>REMS cutter wheel Cu-INOX</b> for stainless steel pipes of pressfitting systems, copper, carbon steel	845050R	111,07
<b>REMS cutter wheel Cu</b> specially for pipes of copper pressfitting systems	845053R	111,07
<b>REMS cutter wheel St</b> for steel pipes, cast iron pipes (SML)	845052R	111,07
<b>REMS cutter wheel V</b> for plastic and multilayer composite pipes, wall thickness $s \leq 10$ mm	845051R	111,07
<b>REMS cutting wheel C-SF</b> especially for pipes of the pressfitting systems and push fitting systems made from carbon steel, simultaneously produces a chamfer.	845055R	111,07
<b>Pipe support 1</b> , height adjustable, for pipes $\varnothing$ 40–110 mm, $\varnothing$ $1\frac{1}{2}$ –4", with operation of the drive unit with feed lever on the floor	845220R	152,59
<b>Hardened, precision tubular steel rollers (pack of 4)</b>	845118R	214,87
<b>Stainless tubular steel INOX rollers (pack of 4)</b>	845110RINOX	303,10
<b>Marking device</b> for marking the insertion depth for fittings on pipes. For REMS Cento, REMS Cento 22V.	845530R	129,75

**REMS REG 10–54 E**, outer/inner pipe deburrer, see page 99

<b>REMS REG 28–108</b> , inner pipe deburrer for pipes $\varnothing$ 28–108 mm, $\varnothing$ $\frac{3}{4}$ –4", for electric rotary drive by the cutting wheel of the REMS Cento, REMS Cento 22V pipe cutting machine (with REMS cutting wheel Art. No. 845050 or 845053).	113840R	333,20
<b>Stand</b>	849315R	216,94
<b>Wheel stand</b>	849310R	351,88

**REMS Jumbo**, folding workbenches, see page 106.

**REMS Herkules**, material supports, see page 107.

**REMS Lumen 2800 22V**, cordless LED flood light, see page 111

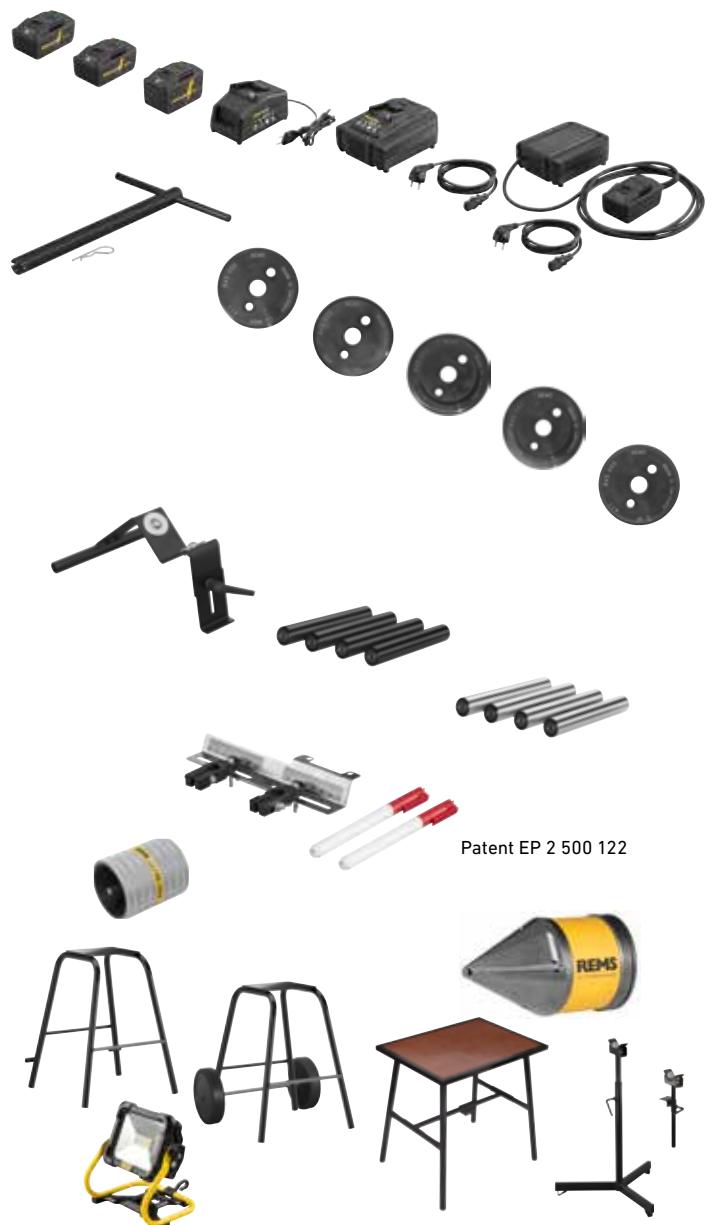

Robust, mobile compact machine. Universal for cutting pipes. For trade and industry. For the building site and the workshop.

Stainless steel pipes of pressfitting systems, carbon steel, copper	Ø 54–225 mm
Steel pipes EN 10255 (DIN 2440)	DN 40–150 Ø 1½–6"
Cast iron pipes (SML) EN 877 (DIN 19522)	DN 50–200
Plastic pipes SDR 11	
Wall thickness $s \leq 21$ mm	Ø 40–225 mm
Multilayer composite pipes	Ø 40–110 mm

**REMS DueCento – Cutting up to Ø 225 mm.**  
**Right angled. Chip-free. Ready for welding. Fast.**  
**No outer burr. Dry cutting.**

### Universal for many pipe types.

**Right angled cutting**, according to requirements  
**Chip-free**, no chips in the pipe system, no dust  
**Weldable**, for muff and butt welds  
**Fast**, without impairment of the pipe material by overheating  
**Without outside burr**, easy insertion into connecting muffs  
**Dry cutting**, without impairment by coolant lubricants

### Design

Compact, mobile pipe cutting machine for fast, right angled, cutting with no outer burr. Handy and easily transportable, only 37 kg. Stable, distortion-free cast construction for right angled cutting. Easy pipe-cutting through specially designed cutter wheel. Powered cutter wheel and linear advance for fast cutting (**Patent EP 1 782 904**). Power saving feed-in through easy to grip, proven advance-lever and needle bearing mounted machine screw spindle. Cutter wheel protected – as movement restricted to before any contact with the rollers. Practical chassis with two rubber tyred wheels for easy transport.

### Running rollers

4 strong hardened precision tubular steel running rollers on ball bearings for low-friction turning of the pipes to be cut, arranged in convex square for centred thrust pressure of the cutting wheel in the working range Ø 100–225 mm, Ø 4–6", without setting work (**Patent EP 2 740 556**). Roller insert for cutting pipes Ø 40–110 mm, Ø 1½–4", as an accessory.

### Drive

Robust gear, precisely mounted in roller and needle bearings, maintenance-free. Proven universal motor, 1200 W. Powerful, e.g. plastic tube PE Ø 225 mm in just 15 s. Ideal speed 115 rpm for optimum cutting speed of the pipes. Safety foot-switch with emergency stop.

### REMS cutter wheels

Top German quality. Cutter wheels specially designed to the performance capability of the REMS DueCento and for numerous pipe materials with variable cutting geometries for fast cutting with no outer burr. Specially hardened, from proven, through-hardened REMS die-steel, ensuring long service life.

### Pipe supports

Pipe supports, height adjustable, for pipes Ø 40–110 mm, Ø 1½–4" and Ø 100–225 mm, Ø 4–8". Easy moving of the material in all directions when turning, pulling and pushing by four stainless steel balls mounted in a rust-protected housing. Safe guiding of long pipes by use of several pipe supports.

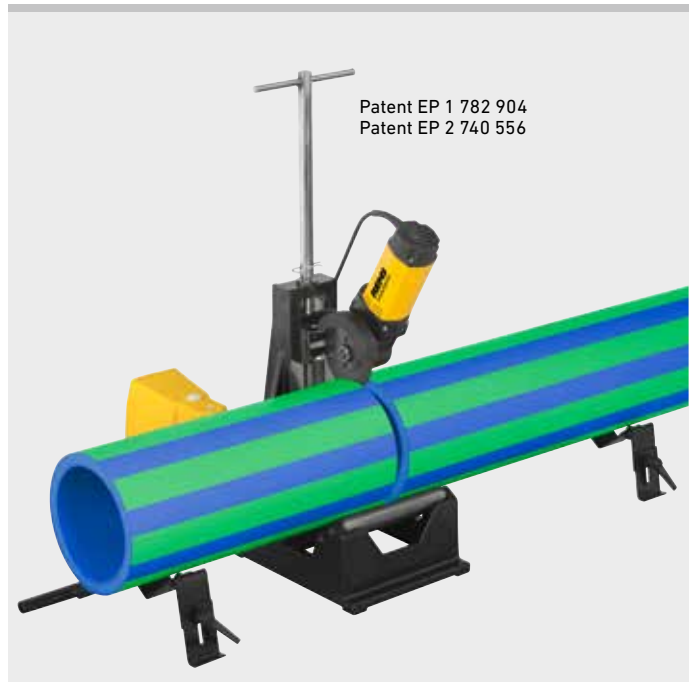

German Quality Product



Info

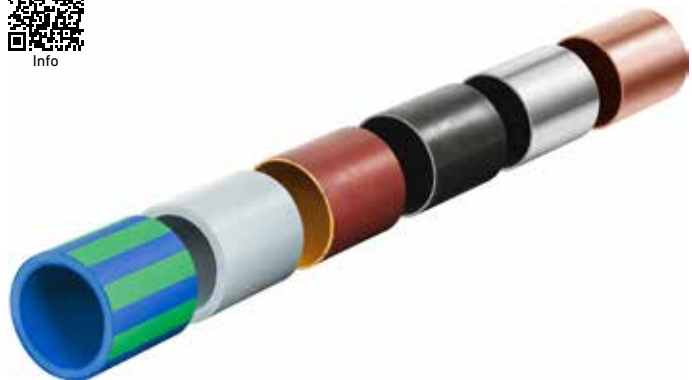



## Supply format

**REMS DueCento Basic.** Pipe cutting machine for fast, right angled cutting of pipes Ø 40–225 mm, without outside burr. For pipes of the press fitting systems made from stainless steel, carbon steel, copper, Ø 54–225 mm. For steel pipes EN 10255 (DIN 2440) DN 40–150, Ø 1½–6", cast pipes (SML) EN 877 (DIN 19522) DN 50–200, plastic tubes SDR 11, wall thickness  $s \leq 21$  mm, Ø 40–225 mm, Ø 1½–8", composite tubes Ø 40–110 mm. With maintenance-free gears, proven universal motor 110 / 230 V, 50–60 Hz, 1,200 W. Speed 115 rpm. Hardened, precision tubular steel rollers for pipes Ø 100–225 mm, Ø 4–6". Safety foot switch. Ring spanner. Without cutter wheel. 2 height adjustable pipe supports 1 for pipes Ø 100–225 mm, Ø 4–8". In a carton.

	Art.-No.	€
	845004R220	<b>2.896,02</b>

Other voltages on request.



## Accessories

Description	Art.-No.	€
<b>REMS cutter wheel Cu-INOX</b> for stainless steel pipes of pressfitting systems, copper, carbon steel	845050R	<b>111,07</b>
<b>REMS cutter wheel Cu</b> specially for pipes of copper pressfitting systems	845053R	<b>111,07</b>
<b>REMS cutter wheel St</b> for steel pipes, cast iron pipes (SML)	845052R	<b>111,07</b>
<b>REMS cutting wheel C-SF</b> especially for pipes of the pressfitting systems and push fitting systems made from carbon steel, simultaneously produces a chamfer.	845055R	<b>111,07</b>
<b>REMS cutter wheel V, s 10</b> for plastic and multilayer composite pipes, wall thickness $s \leq 10$ mm	845051R	<b>111,07</b>
<b>REMS cutter wheel P, s 21</b> for plastic and multilayer composite tubes, wall thickness $s \leq 21$ mm	845057R	<b>140,13</b>
<b>Pipe support 1</b> , height adjustable for pipes Ø 100–225 mm, Ø 4–8"	845220R	<b>152,59</b>
<b>Pipe support 2</b> , height adjustable, for pipes Ø 40–110 mm, Ø 1½–4" (roller insert required)	845230R	<b>152,59</b>
<b>Roller insert</b> for cutting pipes Ø 40–110 mm, Ø 1½–4"	845060R	<b>242,89</b>

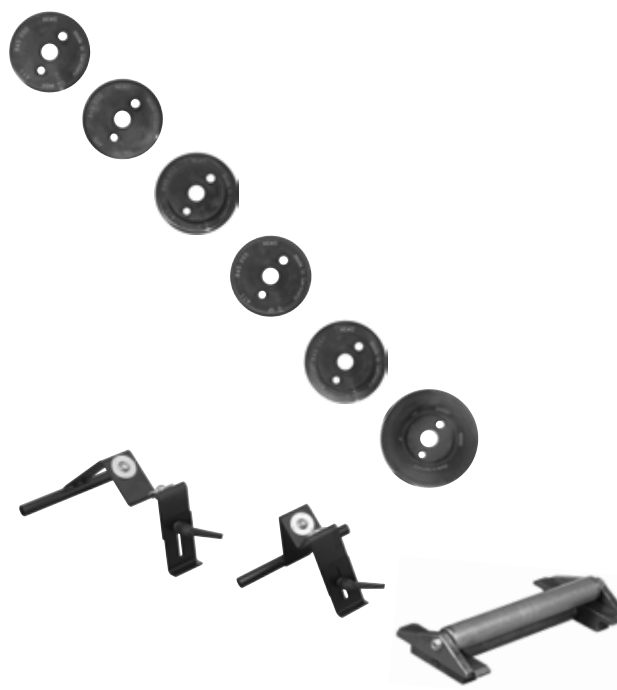

Robust quality tool for clean, fast cutting of pipes in one cut. Stable magnesium version. For one-hand operation.

Flexible plastic hoses,  
soft plastic pipes  $\leq \varnothing 28 \text{ mm}$   
 $\leq \varnothing 1\frac{1}{8}''$

### REMS ROS P flex – Fast cutting in one cut. Ideal for cutting flexible plastic hoses and soft plastic pipes.

Stable magnesium version, extremely light.

Ergonomically designed handles for fast cutting in one cut. For one-hand operation.

Blade drawback by spring-loaded articulated lever.

Specially hardened and specially ground, wedge-shaped blade with cutting angle of 110°, PTFE-coated. Ideal for cutting hoses and soft plastic pipes.

Right-angled, burr-free cutting by pipe rests on both sides and bilaterally clamped blade.

One-hand locking for safe transport and protection of the blade.

Chip-free cutting – no chips left in the pipe.

REMS ROS P flex 28 S with softgrip. Needle bearing-mounted articulated lever for easy cutting in one step.



Info



### Supply format

REMS ROS P flex. One-hand pipe shears for flexible plastic hoses and soft plastic pipes. With blade. In blister pack.

Description	Pipes $\leq \varnothing$ mm/inch	Art.-No.	€
<b>P flex 14</b>	14 $\frac{9}{16}''$	291400R	<b>53,46</b>
<b>P flex 22</b>	22 $\frac{7}{8}''$	291410R	<b>59,79</b>
<b>P flex 28 S</b> on needle bearings	28 $1\frac{1}{8}''$	291430R	<b>84,08</b>

### Accessories

Description	Art.-No.	€
<b>Blade P flex 14</b> for REMS ROS P flex 14	291401R	<b>26,73</b>
<b>Blade P flex 22</b> for REMS ROS P flex 22	291411R	<b>29,84</b>
<b>Blade P flex 28</b> for REMS ROS P flex 28 S	291431R	<b>33,58</b>



# REMS ROS P 26/SW 35 S

One-hand pipe shears

Robust quality tool for clean, fast cutting of pipes in one cut. With integrated pipe cutter for protective corrugated tubes. Stable magnesium version. For one-hand operation.

Plastic tubes, composite tubes	≤ Ø 26 mm ≤ Ø 1"
Protective corrugated plastic tubes	Ø 18–35 mm Ø ¾–1⅜"

**REMS ROS P 26/SW 35 S – Universal for many materials. Ideal for cutting composite pipes and PEX pipes. Fast cutting in one cut. With integrated pipe cutter for protective plastic corrugated tube.**

- Stable magnesium version, extremely light.
- Ergonomically designed handles with softgrip for fast cutting in one cut. For one-hand operation.
- Needle bearing-mounted articulated lever for easy cutting in one step.
- Blade drawback by spring-loaded articulated lever.
- One-hand locking for safe transport and protection of the blade.
- Specially hardened and specially ground, rounded blade for low-wear working, PTFE-coated. 4 counter pressure rollers on needle bearings. For easy swivelling of the pipe shears during the cutting process. Ideal for cutting composite pipes, PEX pipes and similar.
- Right-angled, burr-free cutting by extra-wide pipe rests on both sides and bilaterally clamped blade.
- Cutting of protective corrugated pipes by 4 cutting tools at the end of the handle.
- Three-edged, wedge-shaped cutting tools with a cutting angle of 120°, rotatable 3 times by 120° for three times longer life.
- Cutting depth limiting of the cutting tools during cutting of corrugated protective pipes prevents damage to the inside of the pipe.
- Chip-free cutting – no chips left in the pipe.

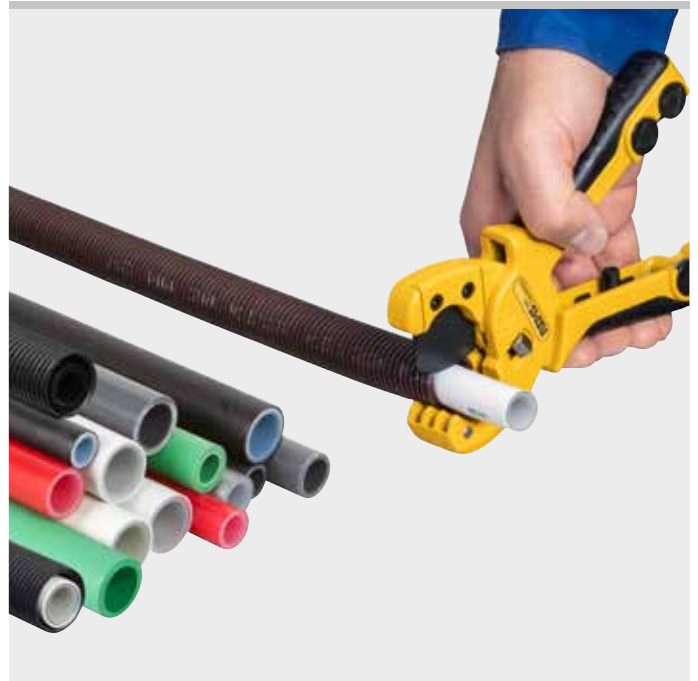

## Supply format

**REMS ROS P 26/SW 35 S.** One-hand pipe shears for plastic and composite pipes with integrated pipe cutter for plastic corrugated protective pipes. 4 counter pressure rollers on needle bearings. With blade and 4 cutting tools. In blister pack.

	Pipes ≤ Ø mm/inch	Art.-No.	€
	P 26/1"	291242R	116,26
	SW 35/1⅜"		



## Accessories

Description	Art.-No.	€
<b>Blade P 26/SW 35</b> for REMS ROS P 26/SW 35 S	291243R	46,50
<b>Cutting tool P26/SW 35, pack of 4</b> for REMS ROS P 26/SW 35 S	291244R	46,50



Robust quality tool for clean, fast cutting of pipes in one cut. Stable magnesium version. For one-hand operation.

Plastic pipes, multilayer composite pipes ≤ Ø 26 mm  
≤ Ø 1"

### REMS ROS P 26 – fast cutting in one cut.

Stable magnesium version, extremely light.

Ergonomically designed handles for fast cutting in one cut. For one-hand operation.

Blade drawback by spring-loaded articulated lever.

One-hand locking for safe transport and protection of the blade.

Specially hardened and specially ground blade, PTFE-coated.

Right-angled, burr-free cut by pipe rest on both sides and blade guided on both sides.

Chipless cutting – no chips remaining in pipe.



Info

### Supply format

**REMS ROS P 26.** One-hand pipe shears for plastic and multilayer composite tubes. With blade. In blister pack.

	Pipes ≤ Ø mm/inch	Art.-No.	€
	26		
	1"	291240R	<b>57,30</b>

Robust quality tool for clean, fast cutting of pipes in one cut. Stable magnesium version. For one-hand operation.

PEX pipes and similar ≤ Ø 28 mm  
≤ Ø 1 1/8"

### REMS ROS PEX 28 S – fast cutting in one cut. Ideal for cutting PEX pipes.

Stable magnesium version, extremely light.

Ergonomically designed handles with softgrip for fast cutting in one cut. For one-hand operation.

Needle bearing-mounted articulated lever for easy cutting in one step.

Blade drawback by spring-loaded articulated lever.

One-hand locking for safe transport and protection of the blade.

Specially hardened and specially ground, wedge-shaped blade with cutting angle of 150° for low-wear working, PTFE-coated. Ideal for cutting PEX pipes.

Right-angled, burr-free cut by pipe rest on both sides and blade guided on both sides.

Chipless cutting – no chips remaining in pipe.



Info

### Supply format

**REMS ROS PEX 28 S.** One-hand pipe shears for PEX pipes, on needle bearing. With blade. In blister pack.

	Pipes ≤ Ø mm/inch	Art.-No.	€
	28 / 1 1/8"	291420R	<b>87,30</b>

### Accessories

Description	Art.-No.	€
<b>Blade P 26</b> for REMS ROS P 26	291241R	<b>22,94</b>
<b>Blade PEX 28</b> for REMS ROS PEX 28 S	291421R	<b>34,82</b>



# REMS ROS P

One-hand pipe shears with ratchet feed/  
pipe shears with ratchet feed

Handy quality tools for clean, fast pipe cuts.  
For thin-walled pipes also. Sturdy aluminium/  
magnesium version. For single-hand operation.

Plastic pipes, multi-layer composite tubes ≤ Ø 63 mm  
≤ Ø 2"

## REMS ROS P 35 / ROS P 35 A / ROS P 42 / ROS P 42 PS / ROS P 42 S / ROS P 63 P / ROS P 63 S

Sturdy aluminium version, REMS ROS P 42 S and magnesium (Mg) version  
P 63 S, ultra light.

Specially hardened, wedge-shaped blade, also for thin-walled pipes.

For single-hand operation. Effortless working through power transmitting  
ratchet feed.

Quick reverse saves time and effort. REMS ROS P 35 A with automatic  
quick reverse after completion of cutting.

Right angle, burr-free cut through exact pipe support and guided blade  
on both sides.

Chipless cutting – no chips remaining in pipe.



### Supply format

**REMS ROS P.** One-hand pipe shears for plastic pipes and multi-layer composite  
tubes. With blade. In blister pack/in box.

Description	Pipes ≤ Ø mm/inch	Art.-No.	€
<b>P 35</b>	35		
with quick reverse	1 3/8"	291200R	<b>62,07</b>
<b>P 35 A</b>	35		
with automatic quick reverse	1 3/8"	291220	<b>79,10</b>
<b>P 42</b>	42		
with quick reverse	1 5/8"	291250R	<b>135,98</b>
<b>P 42 PS</b>	42		
with quick reverse	1 5/8"	291000RPS	<b>83,87</b>
<b>P 42 S</b>	42		
with quick reverse	1 5/8"	291010R	<b>94,46</b>
<b>P 63 P</b>	63		
with quick reverse	2"	291270R	<b>165,04</b>
<b>P 63 S</b>	63		
with quick reverse	2"	291290R	<b>180,61</b>

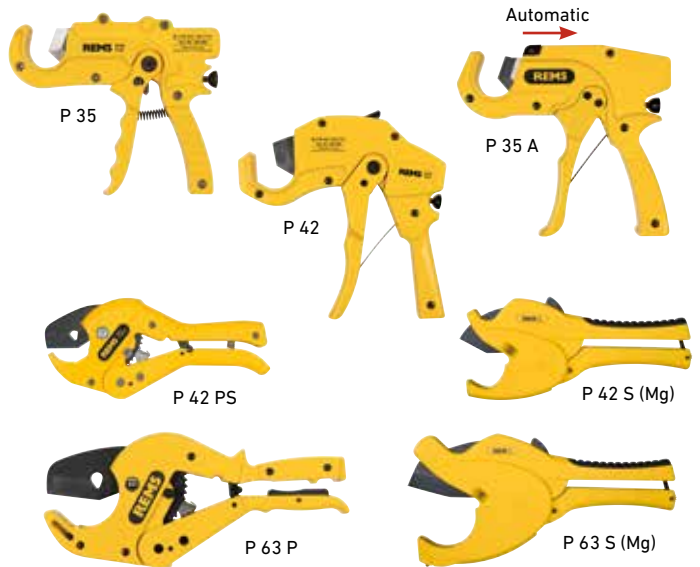

Robust quality tools for clean, fast pipe cuts.  
Robust steel version.

Plastic pipes ≤ Ø 75 mm, ≤ Ø 2 1/2"

## REMS ROS P 75 P

Robust steel version for rugged conditions and long life, with end stop for  
powerful engagement, also ideal for thick-walled plastic pipes.

Rough, non-slip handle for good grip.

Specially hardened and specially ground, wedge-shaped blade with cutting angle  
of 150° for low-wear working.

Fast, easy operation through guided ratchet on both sides and fine-toothed  
ratchet gear, specially hardened.

Right angle, burr-free cut through two-point pipe support and guided blade  
on both sides.

Chipless cutting – no chips remaining in pipe.



### Supply format

**REMS ROS P 75 P.** Pipe shear for plastic pipes. With blade. In a carton.

Description	Pipes ≤ Ø mm/inch	Art.-No.	€
	75 / 2 1/2"	291101R	<b>360,19</b>



### Accessories

Description	Art.-No.	€
<b>Blade P 35</b> for REMS ROS P 35	291201	<b>24,91</b>
<b>Blade P 35 A</b> for REMS ROS P 35 A	291221	<b>31,66</b>
<b>Blade P 42</b> for REMS ROS P 42	291251	<b>54,39</b>
<b>Blade P 42 PS</b> for REMS ROS P 42 PS	291023	<b>33,63</b>
<b>Blade P 42 S</b> for REMS ROS P 42 S	291036R	<b>41,94</b>
<b>Blade P 63 P</b> for REMS ROS P 63 P	291271	<b>66,02</b>
<b>Blade P 63 S</b> for REMS ROS P 63 S	291037R	<b>66,02</b>
<b>Blade P 75 P</b> for REMS ROS P 75 P	291112	<b>144,28</b>

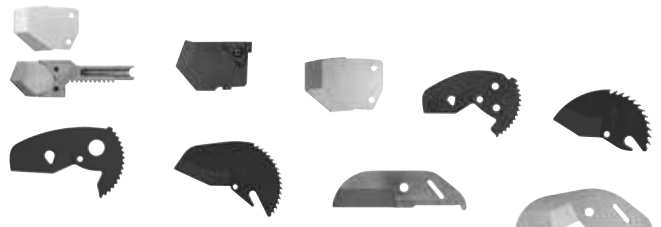

# REMS Cut 110 P

Pipe cutting and pipe chamfering tool

Robust quality tool for right-angle, plain cutting and chamfering (15°) in one operation. Can be used anywhere, free-hand, on parallel vice or work bench.

Plastic pipes in  
ABS, PB, PE, PE-HD, PE-X,  
PP, PVC, PVDF

Ø 40 – 110 mm

## REMS Cut 110 P – cutting and chamfering at the same time.

Robust metal design for tough use.

Cutting and chamfering in one operation. While turning the tool shaft, also cutting only possible.

Fast and easy to use, ergonomic clamping grip.

Spring loaded clamp inserts in plastic for concentric clamping of different pipe sizes. Easy to change without tools.

Steplessly adjustable clamping pressure accommodates pipe tolerances.

Cutting and chamfering tool in hard metal with optimum cutter geometry ensures precise cutting and chamfering. Long service life.

Holder for workbench for effortless operation.

Tool set Cu-INOX and clamp inserts for cutting welded rain gutter pipes in copper, titanium zinc, stainless steel, as accessory.



## Supply format

**REMS Cut 110 P Set.** Pipe cutting and pipe chamfering tool for plastic pipes in ABS, PB, PE, PE-HD, PE-X, PP, PVC, PVDF, Ø 40 – 110 mm. Quick clamping device Ø 110 mm with 2 each of clamping inserts Ø 50 and 75 mm. Tool set P with cutting and chamfering blade P, s 11. In sturdy case.

Description	Art.-No.	€
<b>Set 50 + 75 + 110</b>	290400R	<b>490,97</b>



## Accessories

Description	Pipes Ø mm	Art.-No.	€
<b>Clamping inserts (pack of 2)</b>	40	290420	<b>81,90</b>
	50	290421	<b>81,90</b>
	52	290422	<b>81,90</b>
	56	290444	<b>81,90</b>
	58	290423	<b>81,90</b>
	60	290445	<b>81,90</b>
	63	290427	<b>81,90</b>
	75	290424	<b>81,90</b>
	76	290446	<b>81,90</b>
	78	290425	<b>81,90</b>
	80	290447	<b>81,90</b>
	87	290448	<b>81,90</b>
90	290426	<b>81,90</b>	
100	290449	<b>81,90</b>	
<b>Tool set P</b>			
with cutting and chamfering blade P, s 11		290432R	<b>86,36</b>
<b>Cutting and chamfering blade P, s 11</b>		290430	<b>34,98</b>
<b>Cutting and chamfering blade P, s 15.5</b>		290431	<b>56,05</b>
<b>Tool set Cu-INOX</b>			
with cutter wheel Cu-INOX 3 – 120, s 4		290433R	<b>86,36</b>
<b>REMS cutter wheel Cu-INOX 3 – 120, s 4</b>		113210R	<b>12,04</b>
<b>Holder for work bench</b>		290440R	<b>92,80</b>
<b>Case</b>		290437	<b>64,36</b>

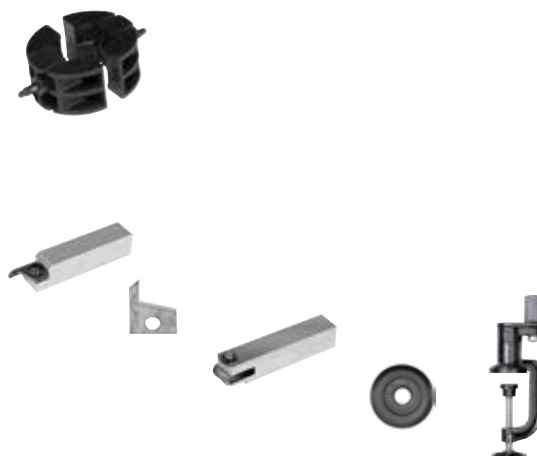

# REMS Cut 110 Cu-INOX

Pipe cutting tool

Robust quality tool for right-angle cutting of welded pipe. Can be used anywhere, free-hand, on parallel vice or work bench.

Welded copper drainpipe/downpipe,  
Titanium zinc, stainless steel (EN 1124) Ø 50 – 110 mm

## REMS Cut 110 Cu-INOX – Easy cutting of downpipes.

Robust metal design for tough use.

Fast and easy to use, ergonomic clamping grip.

Spring loaded clamp inserts in plastic for concentric clamping of different pipe sizes. Easy to change without tools.

Steplessly adjustable clamping pressure accomodates pipe tolerances.

Cutting and chamfering tool in hard metal with optimum cutter geometry ensures precise cutting and chamfering. Long service life.

Holder for workbench for effortless operation.

Tool set P and clamp inserts for right-angle, plain cutting and chamfering (15°) of plastic pipe, as accessory, see page 94.



## Supply format

**REMS Cut 110 Cu-INOX Set.** Pipe cutter for welded drainpipes/downpipes made of copper, titanium zinc, stainless steel (EN 1124), Ø 50 – 110 mm. Quick action clamp Ø 110 mm with clamp inserts. Tool set Cu-INOX with cutter wheel Cu-INOX 3 – 120, s 4. In sturdy case.

Description	Art.-No.	€
<b>Set 50 + 75 + 110</b>	290412R	<b>533,53</b>
<b>Set 60 + 80 + 100 + 110</b>	290410R	<b>643,56</b>
<b>Set 76 + 87 + 100 + 110</b>	290411R	<b>670,55</b>



## Accessories

Description	Art.-No.	€
<b>Clamp inserts</b> , see page 94.		
<b>Tool set Cu-INOX</b> with cutter wheel Cu-INOX 3 – 120, s 4	290433R	<b>86,36</b>
<b>REMS cutter wheel Cu-INOX 3 – 120, s 4</b>	113210R	<b>12,04</b>
<b>Holder for work bench</b>	290440R	<b>92,80</b>



Handy quality tools for simple and fast external chamfering (15°) of pipes.

Plastic pipes  $\varnothing$  16 – 250 mm,  $\varnothing$  3/4 – 10"

Wall thickness  $\leq$  PN 16

### REMS RAG – chamfering at 15°.

Chamfering at 15° on commonly used plastic pipes.

Also suited for deburring plastic pipes. Ensures easy joining of sleeves to be welded.

Easily adjusted for pipe diameter and wall thickness.

Very fast and easy chamfering due to a particularly favourable cutting geometry of the chamfering blades.

Two adjacent, identical chamfering blades, one of which cuts the chamfer and the other one serves as a support for the pipe during chamfering. If the cutting chamfering blade is worn, it can be exchanged with the support part, for double the service life.

Easy-to-slide V-block with two different bevel angles for good guidance of small pipe sizes. In high-grade, glass-fibre reinforced polyamide.



German Quality Product



### Supply format

**REMS RAG.** Pipe chamfering tool for plastic pipes. With blades. In a carton.

Description	Pipes $\leq$ $\varnothing$ mm/inch	Art.-No.	€
<b>P 16 – 110</b>	16 – 110 / 3/4 – 4"	292110R	<b>213,83</b>
<b>P 32 – 250</b>	32 – 250 / 1 1/4 – 10"	292210R	<b>250,16</b>

### Accessories

Description	Art.-No.	€
<b>Chamfering blades (pack of 2)</b> for REMS RAG P 16–250	292011	<b>85,53</b>





# REMS REG Universal

Universal deburrer

Universal quality tool for deburring tubes and edges of different materials.

Copper, steel, brass, aluminium, plastic.

## REMS REG Universal – the all-purpose deburrer.

Robust metal design for tough use.

Easy handling and good grip thanks to ergonomically designed hexagon handle.

Rotating universal deburrer blade in handle accommodates to the work piece edge to be deburred.

Specially hardened and specially ground universal deburrer blade guarantees easy deburring and long service life.

Fast, simple blade replacement by pulling back the front sliding sleeve.

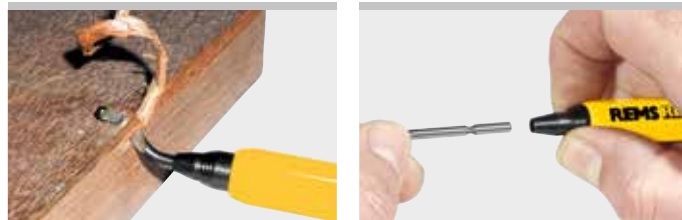

### Supply format

REMS REG Universal. Universal deburrer. For copper, steel, brass, aluminium, plastic. On cardboard.

Description	Art.-No.	€
Universal deburrer	113910R	26,78

### Accessories

Description	Art.-No.	€
Universal deburring blade, ground	113360	7,89



# REMS REG St ¼ – 2"

Inner pipe deburrer

Robust quality tool for inner pipe deburring.

For electric operation.

Steel pipes and other pipes  $\varnothing$  ¼ – 2"

## REMS REG St ¼ – 2": effortless electric deburring.

Inner pipe deburrer with octagonal attachment head for operating by means of electric die stocks with octagonal seat, e.g. REMS Amigo E, REMS Amigo, REMS Amigo 2, REMS Amigo 2 Compact.

Specially hardened and designed deburring blade ensures easy deburring and extremely long life. Double edges for optimum chip flow, specially for small sizes.



German Quality Product



### Supply format

REMS REG St ¼ – 2". Inner pipe deburrer for electric operation. For steel pipes and other pipes,  $\varnothing$  ¼ – 2". In a carton.

Description	Art.-No.	€
Inner pipe deburrer	731700	150,51

# REMS REG 3 – 35

Outer-inner tube deburrer

Sturdy manual tool for outer-inner tube deburring.

Copper, brass, aluminium, steel, plastic tubes

$\varnothing$  3 – 35 mm  
 $\varnothing$  1/8 – 1 3/8"

## REMS REG 3 – 35 – the sharp edge.

Fast, effortless deburring through 3 specially hardened and ground deburring blades.

Robust housing in shock-proof, resistant plastic.



German Quality Product

### Supply format

REMS REG 3 – 35. Outer-inner tube deburrer. For copper, brass, aluminium, steel, plastic tubes,  $\varnothing$  3 – 35 mm,  $\varnothing$  1/8 – 1 3/8". In blister pack.

Description	Art.-No.	€
Outer-inner tube deburrer	113900R	20,03

## REMS REG 8 – 35

Outer-inner pipe deburrer

Robust quality tool for removing outer and inner burr from pipes.

Stainless steel pipes, other steel pipes, copper, brass, aluminium, plastic pipes

Ø 8 – 35 mm  
Ø 3/8 – 1 3/8"

### REMS REG 8 – 35 – the multiple edge up to Ø 35 mm.

Easy, effortless deburring through multiple blades which are specially hardened and ground.

Robust metal design for tough use.



### Supply format

**REMS REG 8 – 35.** Outer-inner pipe and tube deburrer. For stainless steel pipes, other steel pipes, copper, brass, aluminium, plastic pipes, Ø 8 – 35 mm, Ø 3/8 – 1 3/8". In blister pack.

	Art.-No.	€
	113825R	<b>66,95</b>

## REMS REG 10 – 42

Outer-inner pipe deburrer

Robust, solid all-metal tool for outer-inner pipe and tube deburring. For manual or electric operation.

Stainless steel pipes, other steel pipes, copper, brass, aluminium, plastic pipes

Ø 10 – 42 mm  
Ø 1/2 – 1 5/8"

### REMS REG 10 – 42 – by hand or electric. Specially for stainless steel pipes.

Ideal for pipes of all types. Specially for stainless steel tubes of pressfitting systems.

Easy and fast deburring through an appropriate, solid all-metal tool, equipped with 4 specially hardened and ground deburring blades

Driver for electrical drive by REMS Helix 22V VE cordless drill/screwdriver (page 108) and other power drills/screwdrivers (speed ≤ 300 rpm), as an accessory.



German Quality Product



### Supply format

**REMS REG 10 – 42.** Outer-inner pipe and tube deburrer for manual or electric operation. For stainless steel pipes, other steel pipes, copper, brass, aluminium, plastic pipes, Ø 10 – 42 mm, Ø 1/2 – 1 5/8". Without adapter for electric drive. In blister pack.

	Art.-No.	€
	113810R	<b>121,45</b>

### Accessories

Description	Art.-No.	€
<b>Adapter for REMS REG 10 – 42</b>	113815R	<b>52,11</b>
REMS Helix 22V VE, cordless drill/screwdriver, see page 108		



# REMS REG 10 – 54

Outer-inner pipe deburrer

Robust quality tool for removing outer and inner burr from pipes.

Stainless steel pipes, other steel pipes, copper, brass, aluminium, plastic pipes

Ø 10 – 54 mm  
Ø ½ – 2 1/8"

## REMS REG 10 – 54 – the multiple edge up to Ø 54 mm.

Easy, effortless deburring through multiple blades which are specially hardened and ground.

Robust metal design for tough use.



### Supply format

**REMS REG 10 – 54.** Outer-inner pipe and tube deburrer. For stainless steel pipes, other steel pipes, copper, brass, aluminium, plastic pipes, Ø 10 – 54 mm, Ø ½ – 2 1/8". In blister pack.

	Art.-No.	€
	113830R	76,19

# REMS REG 10 – 54 E

Outer-inner pipe deburrer

Robust quality tool for removing outer and inner burr from pipes. For manual operation or electric drive.

Stainless steel pipes, other steel pipes, copper, brass, aluminium, plastic pipes

Ø 10 – 54 mm  
Ø ½ – 2 1/8"

## REMS REG 10 – 54 E – by hand or electrically. Especially for stainless steel pipes.

Easy, effortless deburring through multiple blades which are specially hardened and ground.

Integrated hexagonal driver for electrical drive by REMS Helix 22V VE cordless drill/screwdriver (page 108) and other power drills/screwdrivers with 1/4" bit holders (speed ≤ 300 rpm), by the REMS Cento or REMS Cento 22V pipe cutting machine (page 84 – 87) and by the REMS Turbo Cu-INOX pipe circular sawing machine (page 70) (**Patent EP 2 058 067**).

Robust metal design for tough use.



### Supply format

**REMS REG 10 – 54 E.** Outer-inner pipe and tube deburrer for manual or electric operation. For stainless steel pipes, other steel pipes, copper, brass, aluminium, plastic pipes, Ø 10 – 54 mm, Ø ½ – 2 1/8". In blister pack.

	Art.-No.	€
	113835R	140,13

### Accessories

#### Description

**REMS Helix 22V VE**, cordless drill/screwdriver, see page 108

**REMS Cento**, pipe cutting machine, see page 84

**REMS Cento 22V**, cordless pipe cutting machine, see page 86

**REMS Turbo Cu-INOX**, pipe circular sawing machine, see page 70

# REMS KaliGrat E

Calibrating tool and outer-inner pipe deburrer

Robust, quality tool for calibration and outer-inner deburring of pipes. For manual operation or electric drive.

Multi-layer composite tubes  $\varnothing$  14 – 63 mm

## REMS KaliGrat E – simultaneous calibration and outer-inner deburring. Ratchet handle with changeable calibrating and deburring heads, with quick-change holder.

Universally usable for calibration after the cutting/cropping process, for inner deburring, to avoid damaging the fitting O-ring and for outer deburring.

Easy handling and fast feeding due to ergonomically designed plastic handle with ratchet function.

Robust steel version of the calibrating mandrel with integrated deburring blades for heavy-duty applications and long life. The calibrating mandrel and deburring blades are adapted to different pipe dimensions and wall thicknesses. Sturdy sleeve for protecting the calibrating mandrel and deburring blades from damage.

All calibrating and deburring heads with integrated hexagonal connection for manual operation with the REMS KaliGrat E ratchet handle or for electrical drive by the REMS Helix 22V VE cordless power drill/screwdriver (page 108) and other power drills/screwdrivers with 1/4" bit holders (speed  $\leq$  500 min<sup>-1</sup>).

Quick calibrating and deburring head change by ratchet handle with quick-change holder with spring locking.



### Supply format

**REMS KaliGrat E Set.** Calibrating tool and outer-inner pipe deburrer, for manual operation or electric drive. For  $\varnothing$  14 – 63 mm composite tubes. Ratchet handle with quick-change holder with spring locking, calibrating and deburring heads. In sturdy case.

Version $\varnothing$ mm $\times$ wall thickness mm	Art.-No.	€
Set 16 $\times$ 2 + 20 $\times$ 2 + 25 $\times$ 2.5/26 $\times$ 3	114000R	341,30
Set Allround 26 14 $\times$ 2 + 16 $\times$ 2 + 16 $\times$ 2.25 + 18 $\times$ 2 + 20 $\times$ 2 + 20 $\times$ 2.25 + 20 $\times$ 2.5 + 25 $\times$ 2.5/26 $\times$ 3	114001R	636,00

### Accessories

Description	Art.-No.	€
REMS KaliGrat E ratchet handle, with quick-change holder, for easy driving of the REMS KaliGrat E calibrating and deburring heads	114044R	80,00
REMS KaliGrat E $\varnothing$ 14 $\times$ 2 mm	114032R	50,70
REMS KaliGrat E $\varnothing$ 16 $\times$ 2 mm	114033R	60,00
REMS KaliGrat E $\varnothing$ 16 $\times$ 2.25 mm	114034R	60,00
REMS KaliGrat E $\varnothing$ 18 $\times$ 2 mm	114035R	56,00
REMS KaliGrat E $\varnothing$ 20 $\times$ 2 mm	114036R	64,00
REMS KaliGrat E $\varnothing$ 20 $\times$ 2.25 mm	114037R	64,00
REMS KaliGrat E $\varnothing$ 20 $\times$ 2.5 mm	114038R	64,00
REMS KaliGrat E $\varnothing$ 25 $\times$ 2.5/26 $\times$ 3 mm	114039R	75,10
REMS KaliGrat E $\varnothing$ 32 $\times$ 3 mm	114040R	92,00
REMS KaliGrat E $\varnothing$ 40 $\times$ 3.5 mm	114041R	118,20
REMS KaliGrat E $\varnothing$ 50 $\times$ 4 mm	114042R	168,00
REMS KaliGrat E $\varnothing$ 63 $\times$ 4.5 mm	114043R	308,90
Case with inlay	114030R	62,20
REMS Helix 22V VE, cordless drill/screwdriver, see page 108		



# REMS KaliGrat R

Calibrating tools and inner pipe deburrers

Robust, quality tools for calibration and inner deburring of pipes.

Multi-layer composite tubes Ø 16 – 63 mm

## REMS KaliGrat R – simultaneous calibration and inner deburring. Ratchet handle with graduated calibrating mandrel with integrated deburring blades.

Universally usable for composite tubes for calibration after the cutting/cropping process and for inner deburring, to avoid damaging the fitting O-ring.

Easy handling and fast feeding due to ergonomically designed plastic handle with ratchet function.

Robust steel version of the calibrating mandrel with integrated deburring blades for heavy-duty applications and long life. The graduated calibrating mandrel and deburring blades are adapted to different pipe dimensions and wall thicknesses.



### Supply format

**REMS KaliGrat R.** Calibrating tool and inner pipe deburrer. For Ø 16 – 63 mm composite tubes. Ratchet handle with calibrating mandrel for different diameters and wall thicknesses, with integrated deburring blades. In blister pack.

Version Ø mm × wall thickness mm	Art.-No.	€
R4 16×2 + 20×2 + 25×2.5/26×3 + 32×3	114045R	97,80
R4 16×2 + 20×2.25 + 25×2.5/26×3 + 32×3	114046R	97,80
R3 40×3.5 + 50×4 + 63×4.5	114047R	195,60
R3 40×4 + 50×4.5 + 63×6	114048R	195,60



# REMS KaliGrat H

Calibrating tools and outer-inner pipe deburrers

Robust, quality tools for calibration and outer-inner deburring of pipes.

Multi-layer composite tubes Ø 16 – 26 mm

## REMS KaliGrat H – simultaneous calibration and outer-inner deburring. Star handle with calibrating mandrels and deburring blades.

Universally usable for calibration after the cutting/cropping process, for inner deburring, to avoid damaging the fitting O-ring and for outer deburring. One product for several pipe sizes.

Easy handling and fast feeding due to ergonomically designed plastic housing with star handle.

Robust steel version of the calibrating mandrel with integrated deburring blades for heavy-duty applications and long life. The calibrating mandrel and deburring blades are adapted to different pipe dimensions and wall thicknesses. Sturdy sleeve for protecting the calibrating mandrel and deburring blades from damage.



### Supply format

**REMS KaliGrat H.** Calibrating tool and outer-inner pipe deburrer. For composite tubes. In blister pack.

Version Ø mm × wall thickness mm	Art.-No.	€
16×2 + 20×2 + 26×3	114060R	115,60
16×2 + 20×2 + 25×2.5	114061R	115,60





# Assembling

	<b>Water pump pliers</b>	<b>104</b>
	<b>Pipe workstation Chain pipe vices</b>	<b>105</b>
	<b>Folding workbenches</b>	<b>106</b>
	<b>Material supports</b>	<b>107</b>
	<b>Cordless power drill/screwdriver</b>	<b>108</b>
	<b>Electric LED flood light Cordless LED flood light</b>	<b>110</b>

# REMS Catch S

Swedish pattern wrench 'S'

Rugged quality tools for tough use and long service life.

All-steel, drop forged.

Swedish model according to DIN 5234 - Form C.

Pipes ≤ Ø 3"  
Nuts, bolts, flat material

## REMS Catch S – for professional use.

Swedish model with S-shaped jaws for secure 3-point grip. Self-locking thus secure gripping and holding even on smooth pipes. Rugged design in chrome-vanadium steel, all steel, drop forged, tempered, powder-coated. Hardened, highly wear resistant toothing. Ergonomically shaped handle, slip-proof. Stop prevents jamming. Adjusting nut cannot be lost. Reinforced sleeve.

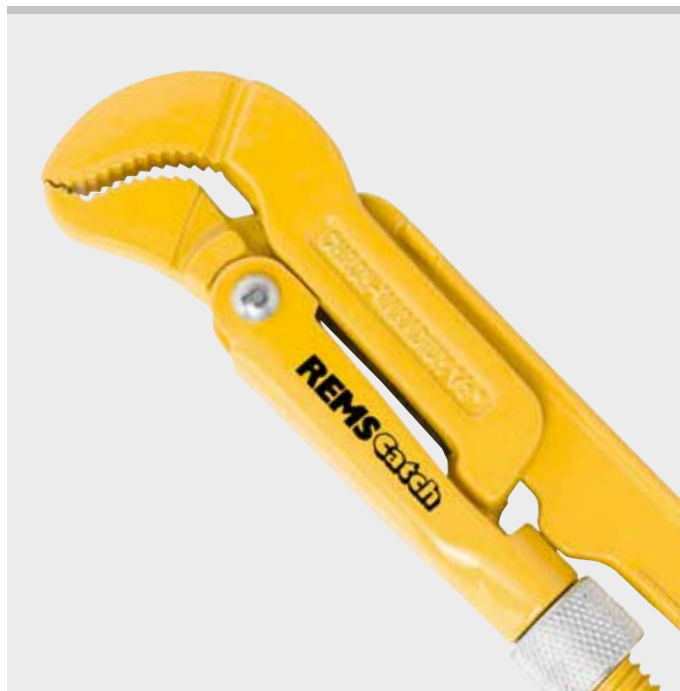

### Supply format

**REMS Catch S.** Swedish pattern wrench 'S'. DIN 5234 – Form C. In plastic bag.

Description Pipes ≤ Ø inch	Width mm	Art.-No.	€
S ½"	36	116000R	51,80
S 1"	47	116005R	55,53
S 1½"	60	116010R	74,53
S 2"	78	116015R	99,44
S 3"	112	116020R	199,30



# REMS Catch W

Water pump pliers

Rugged quality tools for tough use and long service life.

All-steel, drop forged.

According to ISO 8976 with box joint.

Pipes ≤ Ø 1½"  
Square, hexagonal joints, flat material

## REMS Catch W – for professional use.

Gripping pliers with reinforced, ground, box joint. 7 grip positions. Self-locking thus secure gripping and holding, even on smooth pipes. Rugged design in chrome-vanadium steel, all-steel, drop forged, tempered, powder-coated. Hardened, highly wear resistant toothing. Ergonomically shaped handle, slip-proof. Stop prevents jamming.



### Supply format

**REMS Catch W.** Water pump pliers, 7 grip positions. ISO 8976. In plastic bag.

Description	Pipes ≤ Ø inch	Art.-No.	€
W 175	1"	116050R	25,43
W 240	1¼"	116055R	29,27
W 300	1½"	116060R	43,08





# REMS Aquila 3B

Portable pipe workstation with chain pipe vice

Sturdy, easy to carry pipe workstation with integrated chain pipe vice on folding tripod stand. With practical shelf plate. For trade and industry. For the building site and the workshop.

Clamping range	Ø 10 – 165 mm Ø 1/8 – 6"
Load capacity	≤ 450 kg

## REMS Aquila 3B – portable pipe workstation. Safe clamping of pipes up to 6". Everywhere on site.

Sturdy, torsion-free die-cast structure of the work plate with integrated chain pipe vice, pipe rest, tool holders, 3 benders for bending pipes Ø 10 – 26 mm, Ø 3/8 – 3/4", clamping head.

Specially toothed double clamping jaws, easily changeable, prism-shaped, for safe clamping of the pipes in the whole working range. Specially hardened, for long life.

Clamping chain with strong chain links, easy clamping by quick closure and trapezoidal threaded spindle.

Well accessible working range in front of the chain pipe vice for free swing of even long tools.

Especially suitable for pipe installation, e.g. for cutting, thread cutting, bending, assembly.

Adjustable clamping head for clamping the pipe workstation between the ceiling and the floor, for especially secure standing.

Proven tripod stand for secure standing, folding, for easy erection and transport. Practical shelf plate for tools and work material.

REMS Herkules height adjustable material supports (see page 107).



Info



### Supply format

**REMS Aquila 3B.** Pipe workstation with chain pipe vice for clamping pipes, solid material Ø 10 – 165 mm, Ø 1/8 – 6". Work plate with integrated chain pipe vice with double clamping jaws, pipe rest, tool holders, 3 benders for bending pipes Ø 10 – 26 mm, Ø 3/8 – 3/4", clamping head. Folding tripod stand with shelf plate. Load capacity ≤ 450 kg. In a carton.

	Art.-No.	€
	120270R	529,38

# REMS Aquila WB

Chain pipe vice for workbench

High quality, robust chain pipe vice for fixing to a workbench. Excellent quality for long life. For trade and industry. For the building site and the workshop.

Clamping range	Ø 10 – 165 mm Ø 1/8 – 6"
----------------	-----------------------------

## REMS Aquila WB – safe clamping of pipes up to 6".

Sturdy, torsion-free die-cast structure of the base plate with integrated chain pipe vice, pipe rest, bender.

Specially toothed double clamping jaws, easily changeable, prism-shaped, for safe clamping of the pipes in the whole working range. Specially hardened, for long life.

Clamping chain with strong chain links, easy clamping by quick closure and trapezoidal threaded spindle.

Well accessible working range in front of the chain pipe vice for free swing of even long tools.

Especially suitable for pipe installation, e.g. for cutting, thread cutting, bending, assembly.

For fixing to the workbench. Pay attention to load capacity of the workbench.

REMS Herkules height adjustable material supports (see page 107).



German Quality Product



Info



### Supply format

**REMS Aquila WB.** High quality chain pipe vice for clamping pipes, solid material Ø 10 – 165 mm, Ø 1/8 – 6". Base plate with integrated chain pipe vice with double clamping jaws, pipe rest, bending device. For work bench. In a carton.

	Art.-No.	€
	120250R	310,36

Sturdy, easy to carry folding workbenches for universal use. Worktop in accordance with DIN 68 705. For trade and industry. For the building site and the workshop.

### REMS Jumbo E – handy and light.

Work top	Birch-Multiplex, 800 × 600 × 22 mm
Height	800 mm
Weight	23 kg
Load capacity	≤ 300 kg

### REMS Jumbo – the indestructible folding workbench.

#### Handy and light. German quality product.

Work top	Beech-Multiplex, 1100 × 700 × 26 mm
Height	800 mm
Weight	28 kg
Load capacity	≤ 300 kg

### REMS Jumbo – assembled and disassembled at lightning speed. With toggle catch. Worktops in accordance with DIN 68 705. Highly resistant up to 300 kg.

Handy and light. REMS Jumbo E only 23 kg, REMS Jumbo only 28 kg.

Worktop made of special Birch-Multiplex plywood (REMS Jumbo E) or Beech-Multiplex plywood (REMS Jumbo), in accordance with DIN 68 705 weather-proof glued, impregnated, vice-proof and tear-proof, flat and torsion-free.

Impact and splinter resistant thanks to steel edge protection. Screws and nuts galvanised,

Especially safe standing by strong tubular steel frame with toggle catch, assembled and disassembled at lightning speed. Easy to carry.

Highly resistant, max. load capacity 300 kg.



German Quality Product



Info

### Supply format

**REMS Jumbo.** Folding workbench with toggle catch. Worktop in accordance with DIN 68 705. Load capacity ≤ 300 kg. In a carton.

Description	Work top	Size mm	Art.-No.	€
<b>REMS Jumbo E</b>	Birch-Multiplex	800 × 600	120240R	<b>289,60</b>
<b>REMS Jumbo</b>	Beech-Multiplex	1100 × 700	120200R	<b>445,30</b>



Vertically adjustable material support with roller guidance for rotating and stationary pipe and solid material. For trade and industry. For the building site and the workshop.

Pipes, solid material  $\varnothing$  (1/8) 3/4 – 6",  $\varnothing$  (6) 26 – 168 mm  
Load capacity  $\leq 150$  kg

### REMS Herkules – the sturdy support.

Easy moving of the material in all directions when turning, pulling and pushing by two stainless steel balls mounted in a rust-protected housing in the range  $\varnothing$  3/4 – 6",  $\varnothing$  26 – 168 mm.

Especially suitable for pipe installation, e.g. for cutting, thread cutting, roll grooving, welding, soldering.

Robust, job site-proven design. Dismantles for transport and stocking.

Optionally on safe standing tripod or with clamping device for workbench.

Height adjustable, REMS Herkules 3B from 690 to 1,180 mm from the floor, REMS Herkules Y from 35 to 580 mm from the workbench surface.

### Supply format

**REMS Herkules.** Vertically adjustable material support for pipes, solid material  $\varnothing$  (1/8) 3/4 – 6",  $\varnothing$  (6) 26 – 168 mm. Optionally on tripod or with clamping device for workbench. Load capacity  $\leq 150$  kg. In a carton.

Description	Version	Art.-No.	€
<b>REMS Herkules 3B</b>	Tripod with protection caps	120120R	<b>334,24</b>
<b>REMS Herkules Y</b>	Clamping fixture for work bench	120130R	<b>201,37</b>



German Quality Product



Info

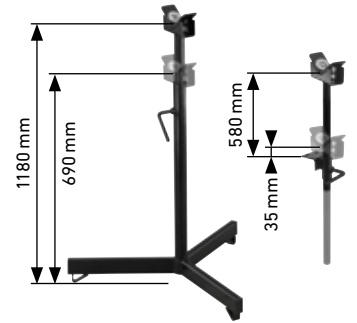

Height adjustable material support with ball guide for rotating and standing tubular and solid material. For trade and industry. For the building site and the workshop.

Pipes, solid material  $\varnothing$  (1/8) 1 1/4 – 12",  $\varnothing$  (6) 42 – 324 mm  
Load capacity  $\leq 450$  kg

### REMS Herkules XL 12" – extra stable for pipes up to 12".

Especially suitable for pipe installation, e.g. for roll grooving, cutting, thread cutting, welding, soldering.

Easy moving of the material in all directions when turning, pulling and pushing by two stainless steel balls mounted in a rust-protected housing in the range  $\varnothing$  1 1/4 – 12",  $\varnothing$  42 – 324 mm.

Robust, job site-proven design. Securely standing tripod, folds up for transport and storage.

Height adjustable from 505 to 915 mm from the floor.

Threaded spindle for simple alignment of the pipe, with fixing device.

Practical handle for easy transport.

### Supply format

**REMS Herkules XL 12".** Height adjustable, fold-up for pipes, solid material  $\varnothing$  1 1/4 – 12",  $\varnothing$  42 – 324 mm. Load capacity  $\leq 450$  kg. In a carton.

	Art.-No.	€
	120125R	<b>362,26</b>

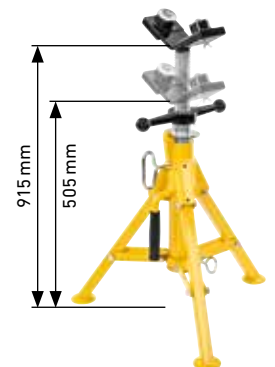

Powerful, mobile, handy power tool for drilling, driving in/loosening screws and deburring pipes. For assembly, disassembly, repair. Li-Ion 22V Technology. For battery and corded operation.

Drilling in steel, stone	≤ Ø 13 mm
Drilling in wood	≤ Ø 32 mm
Drilling with tile drills, e.g. in ceramic, fine clay, granite, marble	≤ Ø 14 mm
Driving in/loosening of screws	≤ Ø 8 mm

**REMS Helix 22 V VE – drilling, screw riving and deburring. With powerful, brushless battery motor.**

### Design

Ultra light, ultra small, ultra handy. Drive machine with battery pack weighs only 1.6 kg. Can therefore be used everywhere, free hand, over head, also in very confined spaces. Optimum weight distribution for one-hand operation. Ergonomically designed housing. Drive machine with keyless quick chuck, clamping range 1.5–13 mm, right and left hand rotation. 2 continuously adjustable speed ranges from 0 to 560 rpm and 0 to 1,900 rpm, 15 torque stages plus drilling stage, hard torque of 50 Nm in both speed ranges, soft torque of 12 Nm in the fast and 30 Nm in the slow speed range for powerful screwdriving. Integrated LED work light for illuminating the work place. Belt clip. For cordless and mains operation. 1 bit with double blade slot/cross-head, 50 mm long. Bit set as accessory.

### Drive

Powerful electro-mechanical drive with powerful, brushless battery motor 21.6V, 500W output, robust, 2-step, precision, ball bearing-mounted gear, maintenance-free. Safety switch.

### Vario-Electronic

Continuous electronic speed control for gentle start drilling, driving in/loosening of screws and selection of the speed suitable for the material when drilling and driving in/loosening screws. The speed can be continuously controlled by variable pressure on the safety switch from 0 to 560 rpm or 0 to 1,900 rpm (accelerator switch (VE)).

### Battery or mains operation

Li-Ion 22V Technology. Highly resistant Li-Ion 21.6V battery with 1.5, 4.4, 5.0 or 9.0Ah capacity, for long service life. Light and powerful. Graduated charging status check by coloured LEDs. Operating temperature range – 10 to + 60 °C. No memory effect for maximum battery power. Rapid charger 100–240V, 90W. Rapid charger 100–240V, 290W, for shorter charging times, as accessory. 220–240V/21.6V, 15A output, voltage supply for mains operation instead of Li-Ion battery 21.6V, as accessory.



Info

## Supply format

**REMS Helix 22 V VE Set.** Cordless power drill/screwdriver with Vario-Electronics (VE) for drilling in steel, stone,  $\leq \varnothing 13$  mm, wood  $\leq \varnothing 32$  mm and other materials and for driving in/loosening screws  $\leq \varnothing 8$  mm. Drive machine with keyless quick chuck, clamping range 1.5 – 13 mm, right and left hand rotation. Electromechanical drive with powerful, brushless battery motor 21.6 V, 500 W, 2-step robust gear. 2 continuously adjustable speed ranges from 0 to 560 rpm and 0 to 1,900 rpm, 15 torque stages plus drilling stage, hard torque of 50 Nm in both speed ranges. Safety switch. Integrated LED work light. Belt clip. Battery Li-Ion 21.6 V, 2.5 Ah, rapid charger 220–240 V or 110 V, 50–60 Hz, 70 W. 1 bit with double blade slot/cross-head, 50 mm long. In carrying bag.

	Art.-No.	€
	190110R220	<b>499,00</b>

Other voltages on request.



## Accessories

Description	Art.-No.	€
<b>REMS REG 10–42.</b> Outer/inner pipe deburrer for pipes $\varnothing 10–42$ mm, $\varnothing \frac{1}{2}–1\frac{1}{8}$ ", see page 98		
<b>REMS REG 10–54 E.</b> Outer/inner pipe deburrer for pipes $\varnothing 10–54$ mm, $\varnothing \frac{1}{2}–2\frac{1}{8}$ ", see page 99		
<b>REMS KaliGrat E.</b> Calibrating tool and outer-inner pipe deburrer for multi-layer composite tubes $\varnothing 14–63$ mm, see page 100		
<b>REMS tile drilling,</b> $\varnothing 5–14$ mm, see page 320		
<b>REMS Helix 22 V VE drive unit,</b> without battery	190100R22	<b>239,00</b>
<b>Battery Li-Ion 21.6 V, 2.5 Ah</b>	571571R22	<b>258,46</b>
<b>Battery Li-Ion 21.6 V, 4.4 Ah</b>	571574R22	<b>372,64</b>
<b>Battery Li-Ion 21.6 V, 5.0 Ah</b>	571581R22	<b>310,36</b>
<b>Battery Li-Ion 21.6 V, 9.0 Ah</b>	571583R22	<b>414,16</b>
<b>Rapid charger 100–240 V, 50–60 Hz, 90 W</b>	571585R220	<b>175,42</b>
<b>Rapid charger 100–240 V, 50–60 Hz, 290 W</b>	571587R220	<b>414,16</b>
<b>Voltage supply 220–240 V/21.6 V, 50–60 Hz, 15 A,</b> for mains operation instead of battery Li-Ion 21.6 V.	571567R220	<b>414,16</b>
<b>Carrying bag</b>	190053R	<b>46,71</b>
<b>Bit set,</b> comprising quick-change bit holder, magnetic, with automatic bit lock, 12 bits (4 Torx, 3 cross-head PH, 3 cross-head PZ, 2 slotted), in practical magazine with elastic band for fixing to wrist or to the power tool.	190051R	<b>15,88</b>
<b>REMS Lumen 2800 22 V,</b> cordless LED flood light, see page 111		



# REMS Lumen 5000/7000/10000

Electric LED flood light

Powerful, electric LED flood light with high light intensity. For the building site and the workshop.

### REMS Lumen 5000

Light flux 5000 lm

### REMS Lumen 7000

Light flux 7000 lm

### REMS Lumen 10000

Light flux brightness stage 1 5000 lm

Light flux brightness stage 2 10000 lm

**REMS Lumen 5000/7000/10000 – electric lighting. With high light intensity. Handy, light. Continuous swivel.**

### Universal use

Powerful, mobile, electric LED flood light with high light intensity for universal use on the building site or in the workshop. REMS Lumen 10000 with 2 selectable brightness stages for any application purpose.

### Design

Handy, light, electric LED flood light. REMS Lumen 5000 only 1.8 kg, REMS Lumen 7000 only 2.2 kg, REMS Lumen 10000 only 3.0 kg. Impact-resistant aluminium housing, dust-proof, protected against water jets from all directions. LEDs protected by impact-resistant, unbreakable acrylic glass. Flood light housing swivels through 360°, fixable by star grips, for optimum alignment of the light. On/Off switch. Tubular steel frame with rubber feet for a firm stand. Practical, non-slip handle. Practical, sturdy, telescopic tripod stand, only 1.9 kg, for accurate positioning of the LED flood light, adjustable height from 615 to 1,590 mm above floor level, collapsible for easy transport, as an accessory.

### LED flood light

Modern, energy-saving LED flood light with high light intensity. Lights immediately without switch-on delay. Brightness of the LEDs in REMS Lumen 10000 selectable in 2 stages. 120° radiation angle for good illumination. Colour temperature 5,000 K. Efficient heat dissipation by high-quality, aluminium, ribbed heat sinks. Overheating regulates the power supply automatically, for continuous operation.

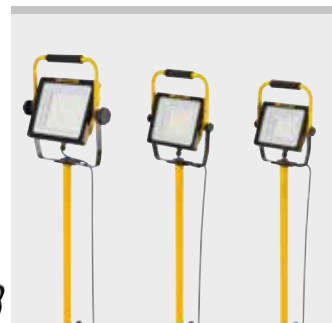
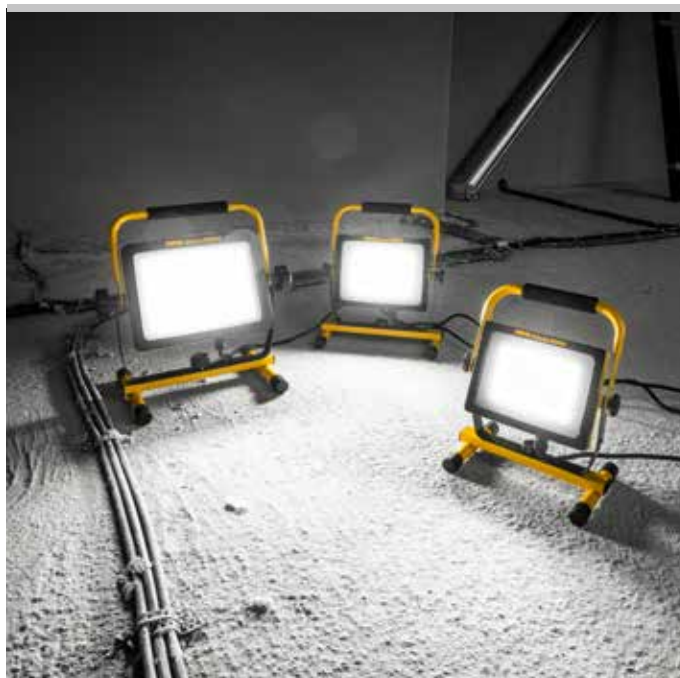

### Supply format

REMS Lumen. Electric LED flood light with high light intensity. 230 V, 50–60 Hz. 5 m connecting lead. In a carton.

Description	Light flux ≤lm	Power ≤W	Art.-No.	€
<b>Lumen 5000</b>	5000	50	175220R220	<b>82,00</b>
<b>Lumen 7000</b>	7000	70	175221R220	<b>98,61</b>
<b>Lumen 10000</b>	10000	100	175222R220	<b>123,52</b>

Other voltages on request.

### Accessories

Description	Art.-No.	€
<b>REMS 3B telescopic stand</b> , on a tripod, height-adjustable, collapsible	175230R	<b>31,04</b>



# REMS Lumen 2800 22V

Cordless LED flood light

Powerful, mobile cordless LED flood light with high light intensity. Li-Ion 22V Technology. For battery and corded operation. For the building site and the workshop.

Light flux brightness stage 1	1100 lm
Light flux brightness stage 2	2000 lm
Light flux brightness stage 3	2800 lm

**REMS Lumen 2800 22V – lights everywhere. With high light intensity. Mobile, handy, light. For battery and corded operation. Continuous swivel.**

## Universal use

Powerful, mobile, cordless LED flood light with high light intensity for universal use on the building site or in the workshop. 3 selectable brightness stages, ideal for any application purpose.

## Design

Handy, lightweight, cordless LED flood light, only 1.7 kg, with battery only 2.1 kg. Impact-resistant plastic housing. LEDs protected by impact-resistant, unbreakable acrylic glass. Flood light housing swivels through 360°, fixable by wing nuts, for optimum alignment of the light. On/Off switch. Tubular steel frame with plastic plate and pluggable hook, for fastening or hanging the flood light. Practical, non-slip handle. 220–240V, 50–60 Hz, 138 W power supply, for mains operation included. Holder for REMS Li-Ion 21.6 V integrated into the housing for cordless instead of mains operation. In cordless operation with Li-Ion 21.6V, 2.5 Ah, 54 Wh (output). Practical, sturdy, telescopic tripod stand, only 1.9 kg, for accurate positioning of the LED flood light, adjustable height from 615 to 1,590 mm above floor level, collapsible for easy transport, as an accessory.

## LED flood light

Modern, energy-saving LED flood light with high light intensity. Lights immediately without switch-on delay. LED brightness selectable in 3 stages. 120° radiation angle for high illumination. Colour temperature 6,500 K. Efficient heat dissipation by high-quality, aluminium, ribbed heat sinks prevents overheating. For continuous operation.

## Battery or mains operation

Li-Ion 22V Technology. Highly resistant Li-Ion 21.6V battery with 2.5, 4.4, 5.0 or 9.0Ah capacity, for long service life. Light and powerful. Graduated charging status check by coloured LEDs. Operating temperature range – 10 to + 60 °C. No memory effect for maximum battery power. Rapid charger 100–240V, 90 W. Rapid charger 100–240V, 290W, for shorter charging times, as accessory.

Description	Operating hours h*		
	Stage 1	Stage 2	Stage 3
Battery Li-Ion 21.6V, 2.5Ah	5.4	2.4	1.6
Battery Li-Ion 21.6V, 4.4 Ah	9.6	4.2	2.8
Battery Li-Ion 21.6V, 5.0Ah	10.9	4.8	3.2
Battery Li-Ion 21.6V, 9.0Ah	19.6	8.6	5.7

## Supply format

**REMS Lumen 2800 22V Set Power-Edition.** Cordless LED flood light with high light intensity. For battery and corded operation. Light flux ≤ 2800 lm. Voltage supply 220–240V, 50–60 Hz, 138W. Without battery, without rapid charger. In a carton.

	Art.-No.	€
	175210R220	144,28

Other voltages on request.

## Supply format

**REMS Lumen 2800 22V Set.** Cordless LED flood light with high light intensity. For battery and corded operation. Light flux ≤ 2800 lm. Battery Li-Ion 21.6 V, 2.5 Ah, rapid charger 220–240V or 110 V, 50–60 Hz, 70 W. Voltage supply 220–240V, 50–60 Hz, 138W. In a carton.

	Art.-No.	€
	175211R220	455,68

Other voltages on request.

## Accessories





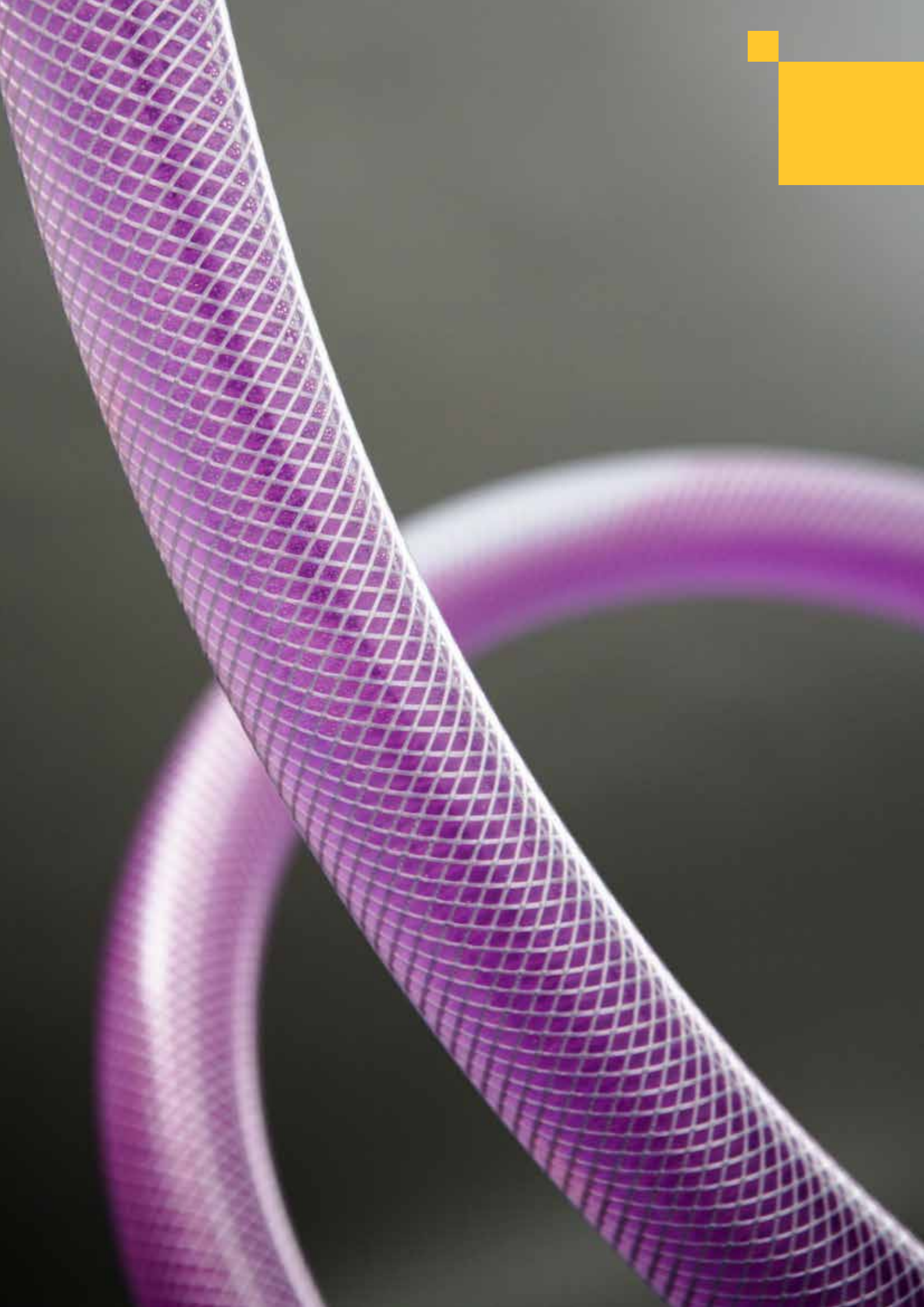



Description	Art.-No.	€
<b>Battery Li-Ion 21.6 V, 2.5 Ah</b>	571571R22	258,46
<b>Battery Li-Ion 21.6 V, 4.4 Ah</b>	571574R22	372,64
<b>Battery Li-Ion 21.6 V, 5.0 Ah</b>	571581R22	310,36
<b>Battery Li-Ion 21.6 V, 9.0 Ah</b>	571583R22	414,16
<b>Rapid charger 100–240V, 50–60 Hz, 90W</b>	571585R220	175,42
<b>Rapid charger 100–240V, 50–60 Hz, 290W</b>	571587R220	414,16
<b>REMS 3B telescopic stand, on a tripod, height-adjustable, collapsible</b>	175230R	31,04







**Pressure testing**  
**Cleaning**  
**Disinfecting**  
**Preserving**  
**Flushing**  
**Filling**

	<b>Hand pressure testing pump</b>	<b>114</b>
	<b>Electric pressure testing pump</b>	<b>115</b>
	<b>Electric decalcifying pump</b>	<b>116</b>
	<b>Electronic flushing unit with compressor</b>	<b>117</b>
	<b>Electronic flushing and pressure testing unit with compressor</b>	<b>120</b>
	<b>Disinfection unit TW, cleaning and preservation unit H</b>	<b>123</b>
	<b>Machine cleaner</b>	<b>123</b>
	<b>Electric filling and flushing unit</b>	<b>124</b>

Proven, reliable testing pump for pressure and tightness tests of piping systems and receptacles.

Testing and pressure range ≤ 6 MPa/60 bar/870 psi

Water, oil, glycol

pH-value of liquids 7–12

Temperature of liquids ≤ 60°C

Viscosity of liquids ≤ 1.5 mPa s

### REMS Push – reliable pressure hold.

#### Universal use

For plumbing, heating, solar system and sprinkler installations, for compressed air, steam and cooling systems, oil installations, for boiler and pressure vessel building.

#### Design

Robust, job-site proven metal design for tough use. REMS Push with corrosion-resistant, powder-coated 12 ltr steel tank. Distortion resistant lever with ergonomic handle, doubles as carrying handle when locked. Wear resistant pressure piston in brass, Ø 30 mm. High-pressure hose with ½"-connection. Fine scale pressure gauge (accessory), p ≤ 1.6 MPa/16 bar/232 psi, for reading a pressure change of 0.01 MPa/0.1 bar/1.45 psi for tightness testing according to DIN 1988, as accessory.

#### Stainless steel tank

REMS Push INOX with 12 ltr stainless steel tank. For extremely long life.

#### Functioning

Pressure and tightness test with water or oil. Double valve system for reliable pressure built-up, with rust-proof steel balls. High pumping capacity with long stroke, fine pressure adjustment at short pushes. High pressure hose with fabric ply prevents measurement errors.



Info

#### Supply format

**REMS Push.** Hand pressure testing pump with pressure gauge, p ≤ 6 MPa/60 bar/870 psi, for pressure and tightness testing of piping systems and receptacles up to 6 MPa/60 bar/870 psi, Corrosion-resistant, powder-coated 12 ltr steel tank. 1.5 m high-pressure hose with ½"-connection. In a carton.

	Art.-No.	€
	115000R	278,18

#### Supply format

**REMS Push INOX.** Hand pressure testing pump with pressure gauge, p ≤ 6 MPa/60 bar/870 psi, for pressure and tightness testing of piping systems and receptacles up to 6 MPa/60 bar/870 psi. 12 ltr stainless steel tank. 1.5 m high-pressure hose with ½"-connection. In a carton.

	Art.-No.	€
	115001R	358,11

#### Accessories

Description	Pressure p ≤ MPa/bar/psi	Art.-No.	€
<b>Connecting piece with pressure gauge and shut off valve</b>	6/60/870	115110R	123,52
<b>Fine scale pressure gauge</b>	1.6/16/232	115045	79,61



# REMS E-Push 2

Electric pressure testing pump

Powerful, electric pressure testing pump for pressure and tightness tests of piping systems and receptacles.

Testing and pressure range ≤ 6 MPa/60 bar/870 psi

Pumping capacity 6.5 l/min

Water, hydrous solutions, emulsions

pH-value of liquids 7–10

Temperature of liquids ≤ 60°C

Viscosity of liquids ≤ 1.5 mPa s

**REMS E-Push 2 – electric charging and testing. Up to 60 bar. With adjustable pressure limiting. 1300 W. Self sucking.**

### Universal use

In sanitary, heating, solar and sprinkler installation, for compressed air, steam and cooling systems, oil installations, in boiler and pressurised vessel construction.

### Design

Robust, compact, light. Weighs only 10 kg. Easy to carry. Wear reduced high power piston pump. Pressure gauge, damped by filling with glycerine,  $p \leq 6$  MPa/60 bar/870 psi. High-pressure hose with fabric ply prevents measurement errors. Suction hose with suction filter. Non-return valve in the suction hose prevents the suction hose from running empty in standstill times; therefore shorter suction times. Suction hose and high pressure hose with  $\frac{1}{2}$ "-connection. Connecting piece with pressure gauge,  $p \leq 6$  MPa/60 bar/870 psi, and shut off valve for pressure and tightness testing also after removal of the high pressure pump, e.g. theft protection or for use at several testing points, as accessory. Fine scale pressure gauge,  $p \leq 1.6$  MPa/16 bar/232 psi, for reading a pressure change of 0.01 MPa/0.1 bar/1.45 psi for tightness testing according to DIN 1988, as accessory.

### High power piston pump

Self-sucking high power piston pump running in a sealed oil bath with wear reduced pressure piston in stainless steel. Proven, powerful capacitor motor, 1300 W, very powerful and fast. High pumping capacity of 6.5 l/min. Pressure and tightness testing up to 6 MPa/60 bar/870 psi.

### Adjustable pressure limiting

Pressure limiting in 6 stages, 1–6 MPa/10–60 bar/145–870 psi, adjustable to the necessary pressure in the pipe system/tank.



Info



### Supply format

**REMS E-Push 2.** Electric pressure testing pump with pressure gauge,  $p \leq 6$  MPa/60 bar/870 psi, for pressure and leak testing of pipe systems and tanks up to 6 MPa/60 bar/870 psi, with adjustable pressure limiting. Pump unit with capacitor motor 230 V, 50 Hz, 1300 W. 1.5 m suction hose with  $\frac{1}{2}$ " connection and gaskets, suction filter with non-return valve. 1.5 m high-pressure hose with  $\frac{1}{2}$ " connection and gaskets. In a carton.

Art.-No.	€
115500R220	943,54

### Accessories

Description	Pressure $p \leq$ MPa/bar/psi	Art.-No.	€
<b>Connecting piece with pressure gauge and shut off valve</b>	6/60/870	115110R	123,52
<b>Fine scale pressure gauge</b>	1.6/16/232	115045	79,61



Powerful, electric decalcifying pump for effective decalcifying of pipes and containers, e.g. flow heaters, boilers, hot water tanks, cold water tanks, heat exchangers, heating and cooling systems.

Useful container volume	21 l
Displacement	≤ 30 l/min
Displacement pressure	≤ 0.1 MPa/1.0 bar/15 psi
Transport height	≤ 10 m
Temperature of decalcifying solution	≤ 50°C

**REMS Calc-Push – effective electric decalcifying. High displacement. 3-way lever for reversal of flow direction, with zero setting.**

### Universal use

For effective decalcifying of pipes and containers, e.g. flow heaters, boilers, hot water tanks, cold water tanks, heat exchangers, heating and cooling systems.

### Design

Robust, compact, light, weights just 9.2 kg. Impact-proof plastic container for the decalcifying solution, useful container volume 21 l, with practical screw-on cap for closing the plastic container during transport. Flexible ½", 2.3 m long flexible PVC fabric hoses, with hose screw fittings with Rp ½" female thread and caps. 3-way lever for reversing the flow direction to remove even heavy lime deposits from both sides, with zero setting to interrupt the flow. Easy to carry due to centrally arranged handle with practical hose holders.

### Unscrewable pump unit

Compact pump unit, consisting of a centrifugal pump and condenser motor, unscrewable, for easy cleaning of the pump unit and the plastic container after the decalcifying process. Self-sucking centrifugal pump, suitable for different decalcifying solutions of acetic acid, sulphuric acid, citric acid, formic acid, phosphoric acid, sulfamic acid. With proven, powerful condenser motor with quiet running, 165W, on/off switch. High displacement ≤ 30 l/min for effective decalcifying.



Info

### Supply format

**REMS Calc-Push.** Electric decalcifying pump for effective decalcifying of pipes and containers, e.g. flow heaters, boilers, hot water tanks, cold water tanks, heat exchangers, heating and cooling systems. Displacement ≤ 30 l/min, useful container volume 21 l. Pump unit with condenser motor 230V, 50 Hz, 165 W. Displacement pressure ≤ 0.1 MPa/1.0 bar/15 psi. Transport height ≤ 10 m. Flexible ½", 2.3 m long flexible PVC fabric hoses, with hose screw fittings with Rp ½" female thread and caps. 2 double nipples ¾" – ½", 2 double nipples ½" – ¾". In a carton.

	Art.-No.	€
	115900R220	<b>829,36</b>

Other voltages on request.



Powerful, compact, electronic flushing unit with oil-free compressor. For flushing with water or a water/air mixture, disinfection, cleaning, preservation of pipe systems and for operation of pneumatic tools.

#### Flushing and desilting

Water pressure pipe network  $p \leq 1 \text{ MPa}/10 \text{ bar}/145 \text{ psi}$   
 Pipe diameter installation  $\leq \text{DN } 50, 2''$

Disinfection of drinking water installations

Cleaning and preservation of radiators and area heating systems

Water temperature  $5 - 35^\circ\text{C}$

Water flow  $\leq 5 \text{ m}^3/\text{h}$

Operation of pneumatic tools

Operating pressure  $p \leq 0.8 \text{ MPa}/8 \text{ bar}/116 \text{ psi}$

Suction rate  $\leq 230 \text{ NI}/\text{min}$

**REMS Multi-Push S – Flushing with water or a water/air mixture. Easy switching of the air supply during the flushing process when desilting. Permanent process monitoring. Logging. USB interface.**

#### Universal use

Only **one** device for flushing with water or a water/air mixture, disinfection, cleaning, preservation of pipe systems, e.g. for desilting, cleaning and preservation of radiators and area heating systems, flushing and disinfection of drinking water installations in accordance with EN 806-4:2010 and for operating pneumatic tools.

#### Design

Powerful, compact, electronic flushing unit with oil-free compressor. Handy, easily portable, only 32 kg. Measuring and control devices for automatically running the flushing programs and for documenting the results. Safety devices for avoiding contamination of the pipe network by flow-back. Overpressure valve for pressure limiting. 5  $\mu\text{m}$  condensation and particle filters. Large tubular steel frame as a compressed air tank. Two practical handles for easy carrying. Space-saving, folding handle grip for easy movement. Mobile tubular steel frame with two rubber-tyred wheels for easy transport and 2 rubber feet for firm standing. Connecting cable with integrated personal protection switch (PRCD). 2 hooks for winding up the power cable. Captive seals for input and output of the REMS Multi-Push S to avoid contamination during transport and storage. Practical hood for protecting the machine during transport and storage as an accessory.

#### Compressor

Proven, powerful, oil-free piston compressor with crank drive, with capacitor motor 230 V, 1500 W. Pressure gauge for displaying the air pressure in the compressed air tank. Emergency stop button.

#### Hoses

Transparent  $\text{Ø } 1''$  suction/pressure hose, with fabric inlay, 1.5 m long, with 1" hose screw fittings, with caps, for flushing, disinfection, cleaning, preservation. Captive caps for the inputs and outputs of the hoses to avoid contamination during transport and storage. Connecting hose compressor/water connections, 0.6 m long, with quick coupling DN 7.2 and 1" hose screw fitting, 1" double nipple, for blowing out water remains from REMS Multi-Push S and suction/pressure hoses at the end of work.

#### Input and control unit

Easy desilting operation by buttons to switch over the air supply during the flushing process. Menu-guided input and menu-guided control for flushing drinking water installations according to EN 806-4:2010 with the possibility for the user to change the factory-set default values for adaptation to the applicable national safety provisions, rules and regulations for the application site. Format selection for date and time and selection of the different units. Input and control unit with 3" display with modern LCD technology, 76 mm screen diagonal, 128 x 64 pixels. Permanent process monitoring during the program sequences. USB port for USB stick or printer. The respective latest version software for the input and control unit is available via USB stick as a download under [www.rems.de](http://www.rems.de) > Downloads > Software.

Patent EP 2 954 960

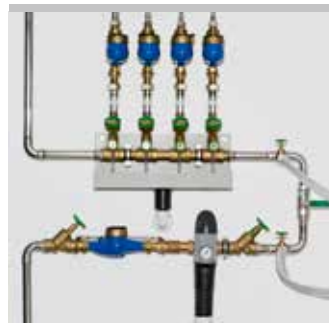

German Quality Product



Info

# REMS Multi-Push S

Electronic flushing unit with compressor

## Desilting and flushing

Buttons for easy switching of the air supply during the flushing process when desilting radiator and flat heater systems with the following possibilities: (1) without compressed air, (2) intermittent compressed air, (3) constant compressed air.

## Flushing according to EN 806-4

Flushing of drinking water installations with water or with a water/air mixture with intermittent compressed air in accordance with EN 806-4:2010 and information leaflet "Flushing, Disinfection and Commissioning of Drinking Water Installations" (August 2014) of the German Central Association for Sanitary, Heating and Air Conditioning (ZVSHK).

## Disinfection

REMS V-Jet TW disinfection unit for disinfection of drinking water installations in accordance with EN 806-4:2010 and information leaflet "Flushing, Disinfection and Commissioning of Drinking Water Installations" (August 2014) of the German Central Association for Sanitary, Heating and Air Conditioning (ZVSHK) and other pipe systems, as an accessory. REMS Peroxi Color, consisting of a 1 l bottle of REMS Peroxi dosing solution for disinfection of approx. 100 l line volume and 20 ml bottle of red REMS Color dye for dyeing the dosing solution for filling and wash-out check, pipette for checking the effectiveness of the dosing solution, as an accessory. Feeding of the disinfectant solution without additional dosing pump (Patent EP 2 954 960).

## Cleaning and preservation

REMS V-Jet H cleaning and preservation unit for cleaning and preserving radiators and area heating systems, as an accessory. Cleaner, dyed green for filling and wash-out check and corrosion protection, dyed blue for filling check, for approx. 100 l line volume respectively, as an accessory. Feeding of cleaner and corrosion protection without additional dosing pump (Patent EP 2 954 960).

## Operation of pneumatic tools

Connection for pneumatic tools up to an air requirement  $\leq 230$  NI/min, adjustable, for adaptation to the pneumatic tool being used. Pressure gauge for controlling the air pressure supplied by the compressed air tank. Pneumatic hose with quick coupling DN 7.2, as an accessory.

## Logging

Results of the flushing programs are saved with date, time and log number in the selected language and can be transferred to USB stick or printer for documentation. Printer as an accessory. Additions to saved data, e.g. customer name, project number, tester, are possible on external devices (e.g. PC, laptop, tablet-PC, Smartphone).



## Supply format

**REMS Multi-Push S Set.** Electronic flushing unit with oil-free compressor. For flushing with water or a water/air mixture, disinfection, cleaning, preservation of pipe systems, e.g. for desilting, cleaning and preservation of radiators and area heating systems, flushing and disinfection of drinking water installations and for operation of pneumatic tools  $\leq 230$  NI/min. Input and control unit. Piston compressor with crank drive, capacitor motor 230V, 50Hz, 1,500 W, person circuit breaker (PRCD). Mobile tubular steel frame. Fastenings for water input and output of the REMS Multi-Push S. Two  $\varnothing 1$ " suction/pressure hoses, with fabric inlay, 1.5 m long, with 1" hose screw fittings, with caps. Connecting hose compressor/ water connections, 0.6 m long, with quick coupling DN 7.2 and 1" hose screw fitting, 1" double nipple, for blowing out water remains from REMS Multi-Push S and suction/pressure hoses at the end of work. Without disinfection unit, without cleaning and preservation unit. In a carton

	Art.-No.	€
	115810R220	2.480,82

Other voltages on request.



# REMS Multi-Push S

Electronic flushing unit with compressor

Description	Art.-No.	€
<b>Fine filter with fine filter cartridge 90 µm</b> , washable, with large dirt collection vessel	115609R	<b>123,52</b>
<b>Fine filter cartridge 90 µm</b> , for fine filter with fine filter cartridge 90 µm	043054	<b>40,07</b>
<b>Compressed air hose Ø 14 mm</b> , 1.5 m long, with quick couplings DN 7.2 (plug, socket), for connecting pneumatic tools	115621R	<b>61,97</b>
<b>Ø 1" suction/pressure hose</b> , with fabric inlay, 1.5 m long, with G 1" screw fittings for flushing, disinfection, cleaning, preservation and pressure testing with water.	115633R	<b>59,27</b>
<b>Double nipple 1"</b> , for connecting 2 suction/pressure hoses and blowing out the suction/pressure hoses	045159	<b>10,38</b>
<b>Printer</b> for printing the stored results of the flushing and test programs, 1 roll of paper, USB connecting cable, power supply/charger Ni-Mh 100–240 V, 50–60 Hz, 3 W	115604R	<b>508,62</b>
<b>Paper roll</b> , pack of 5 for printer	090015R	<b>18,89</b>
<b>Case</b> with inlays for printer, paper rolls and other accessories	115703R	<b>70,58</b>
<b>REMS V-Jet TW</b> , disinfection unit for drinking water installations, for feeding dosing solution for disinfection	115602R	<b>304,13</b>
<b>REMS Peroxi Color</b> , 1 l bottle of REMS Peroxi dosing solution for disinfection of approx. 100 l line volume, 20 ml bottle of red REMS Color dye for dyeing the dosing solution for filling and wash-out check, pipette for checking the effectiveness of the dosing solution.	115605R	<b>82,00</b>
<b>Test strips H<sub>2</sub>O<sub>2</sub> 0–1,000 mg/l, pack of 100</b> , for checking the concentration of the disinfection solution	091072	<b>71,21</b>
<b>Test strips H<sub>2</sub>O<sub>2</sub> 0–50 mg/l, pack of 100</b> , for checking the complete flushing out of the disinfection solution after disinfection	091073	<b>71,21</b>
<b>REMS V-Jet H</b> , cleaning and preservation unit for radiators and area heating systems, for feeding cleaner and corrosion protection.	115612R	<b>304,13</b>
<b>REMS CleanH</b> 1 l bottle of cleaner for radiators and area heating systems, dyed green for filling and wash-out check, for approx. 100 l line volume.	115607R	<b>57,09</b>
<b>REMS NoCor</b> 1 l bottle of corrosion protection for preservation of radiators and area heating systems, dyed blue for filling check, for approx. 100 l line volume.	115608R	<b>61,24</b>
<b>Hood</b> for protecting the machine during transport and storage	115677R	<b>39,24</b>
<b>XL-Boxx system case</b> for hoses	579600RMP	<b>198,26</b>



# REMS Multi-Push SL/SLW

Electronic flushing and pressure testing unit with compressor

Powerful, compact, electronic flushing and pressure testing unit with oil-free compressor. For flushing with water or a water/air mixture, disinfection, cleaning, preservation of pipe systems, for pressure testing of pipe systems and vessels with compressed air or water, as a pneumatic pump for controlled filling of all types of vessels with compressed air and for operation of pneumatic tools.

## Flushing and desilting

Water pressure pipe network  $p \leq 1 \text{ MPa}/10 \text{ bar}/145 \text{ psi}$

Pipe diameter installation  $\leq \text{DN } 50, 2''$

## Disinfection of drinking water installations

Cleaning and preservation of radiators and area heating systems

Water temperature  $5 - 35^\circ\text{C}$

Water flow  $\leq 5 \text{ m}^3/\text{h}$

## Pressure test

with compressed air  $p \leq 0.4 \text{ MPa}/4 \text{ bar}/58 \text{ psi}$

Pressure test with water  $p \leq 1.8 \text{ MPa}/18 \text{ bar}/261 \text{ psi}$

Pneumatic pump for controlled filling of all types of vessels with compressed air  $p \leq 0.8 \text{ MPa}/8 \text{ bar}/116 \text{ psi}$

## Operation of pneumatic tools

Operating pressure  $p \leq 0.8 \text{ MPa}/8 \text{ bar}/116 \text{ psi}$

Suction rate  $\leq 230 \text{ NI}/\text{min}$

**REMS Multi-Push SL/SLW – just one device with more than 10 automatically running flushing and pressure testing programs. Permanent process monitoring. Logging. USB interface.**

## Universal use

Only **one** device for flushing with water or a water/air mixture, disinfection, cleaning, preservation of pipe systems, for pressure testing of pipe systems and vessels with compressed air or water, e.g. drinking water installations, radiators or area heating systems, for pressure testing of gas installations with compressed air, as a pneumatic pump for controlled filling of all types of vessels with compressed air, e.g. for pumping up expansion vessels or tyres and for operating pneumatic tools. (Patent EP 2 816 231).

## Design

Powerful, compact, electronic flushing and pressure testing unit with oil-free compressor. Handy, easily portable, REMS Multi-Push SL only 37 kg, REMS Multi-Push SLW only 39 kg. Measuring and control devices for automatically running the flushing and test programs and for documenting the results. Safety devices for avoiding contamination of the pipe network by flow-back. Overpressure valves for pressure limiting. 5  $\mu\text{m}$  condensation and particle filters. Large tubular steel frame as a compressed air tank. Two practical handles for easy carrying. Space-saving, folding handle grip for easy movement. Mobile tubular steel frame with two rubber-tyred wheels for easy transport and 2 rubber feet for firm standing. Connecting cable with integrated personal protection switch (PRCD). 2 hooks for winding up the power cable. Captive seals for inputs and outputs of the hoses to avoid contamination during transport and storage. Practical hood for protecting the machine during transport and storage as an accessory.

REMS Multi-Push SLW additionally with hydro-pneumatic water pump for generating the necessary water pressure for hydrostatic pressure testing of pipe systems and vessels with water.

## Compressor

Proven, powerful, oil-free piston compressor with crank drive, with capacitor motor 230V, 1500W. Pressure gauge for displaying the air pressure in the compressed air tank. Emergency stop button.

## Hoses

Transparent  $\varnothing 1''$  suction/pressure hose, with fabric inlay, 1.5 m long, with 1" hose screw fittings, with caps, for flushing, disinfection, cleaning, preservation and pressure testing with water. High-pressure hose  $\varnothing \frac{1}{2}''$ , with fabric inlay, 1.5 m long, with  $\frac{1}{2}''$  hose screw fittings, with caps, for pressure testing with water with REMS Multi-Push SLW. Captive caps for the inputs and outputs of the hoses to avoid contamination during transport and storage. Compressed air hose  $\varnothing 8 \text{ mm}$ , 1.5 m long, with quick coupling DN 5 and  $\frac{1}{2}''$  hose screw fitting, for pressure testing with compressed air. Compressed air hose  $\varnothing 8 \text{ mm}$ , 1.5 m long, with quick coupling DN 5 (plug, socket) for gas testing with compressed air. Connecting hose compressor/water connections, 0.6 m long, with quick coupling DN 7.2 and 1" hose screw fitting, 1" double nipple, for blowing out water remains from REMS Multi-Push SL/SLW and suction/pressure hoses at the end of work.

Patent EP 2 816 231  
Patent EP 2 954 960

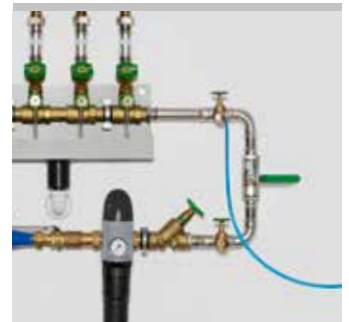
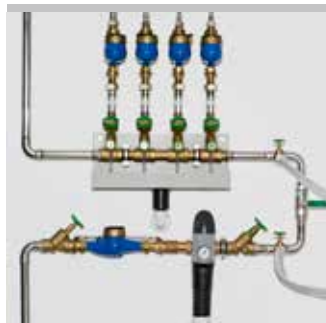

German Quality Product



### Input and control unit

More than 10 flushing and test programs in 26 languages. Easy desilting operation by buttons to switch over the air supply during the flushing process. Menu-guided input and menu-guided control for flushing drinking water installations according to EN 806-4:2010 with the possibility for the user to change the factory-set default values for adaptation to the applicable national safety provisions, rules and regulations for the application site. Format selection for date and time and selection of the different units. Input and control unit with 3" display with modern LCD technology, 76 mm screen diagonal, 128 x 64 pixels. Permanent process monitoring during the program sequences. USB port for USB stick or printer. The respective latest version software for the input and control unit is available via USB stick as a download under [www.rems.de](http://www.rems.de) > Downloads > Software.

### Desilting and flushing

Buttons for easy switching of the air supply during the flushing process when desilting radiator and flat heater systems with the following possibilities: (1) without compressed air, (2) intermittent compressed air, (3) constant compressed air.

### Flushing according to EN 806-4

Flushing of drinking water installations with water or with a water/air mixture with intermittent compressed air in accordance with EN 806-4:2010 and information leaflet "Flushing, Disinfection and Commissioning of Drinking Water Installations" (August 2014) of the German Central Association for Sanitary, Heating and Air Conditioning (ZVSHK).

### Disinfection

REMS V-Jet TW disinfection unit for disinfection of drinking water installations in accordance with EN 806-4:2010 and information leaflet "Flushing, Disinfection and Commissioning of Drinking Water Installations" (August 2014) of the German Central Association for Sanitary, Heating and Air Conditioning (ZVSHK) and other pipe systems, as an accessory. REMS Peroxi Color, consisting of a 1 l bottle of REMS Peroxi dosing solution for disinfection of approx. 100l line volume and 20 ml bottle of red REMS Color dye for dyeing the dosing solution for filling and wash-out check, pipette for checking the effectiveness of the dosing solution (page 123). Feeding of the disinfectant solution without additional dosing pump (Patent EP 2 954 960).

### Cleaning and preservation

REMS V-Jet H cleaning and preservation unit for cleaning and preserving radiators and area heating systems, as an accessory. Cleaner, dyed green for filling and wash-out check and corrosion protection, dyed blue for filling check, for approx. 100 l line volume respectively (page 123). Feeding of cleaner and corrosion protection without additional dosing pump (Patent EP 2 954 960 pending).

### Pressure testing with compressed air

Leak testing of drinking water installations with compressed air according to information leaflet "Leak Testing of Drinking Water Installations with Compressed Air, Inert Gas or Water" (January 2011) of the German Central Association for Sanitary, Heating and Air Conditioning (ZVSHK), leak testing of gas installations with compressed air according to the technical rule "DVGW-TRGI 2018, Technical Rules for Gas Installations - DVGW Worksheet G 600" of the German Gas and Water Association (DVGW) and leak testing of other pipe systems and vessels with compressed air.

Load testing of drinking water installations with compressed air according to information leaflet "Leak Testing of Drinking Water Installations with Compressed Air, Inert Gas or Water" (January 2011) of the German Central Association for Sanitary, Heating and Air Conditioning (ZVSHK), load testing of gas installations with compressed air according to the technical rule "DVGW-TRGI 2018, Technical Rules for Gas Installations - DVGW Worksheet G 600" of the German Gas and Water Association (DVGW) and load testing of other pipe systems and vessels with compressed air.

### Pressure testing with water

REMS Multi-Push SLW with hydro-pneumatic water pump for hydrostatic pressure testing of drinking water installations with water in accordance with EN 806-4:2010, test method A, B or C or test method B, modified in accordance with information leaflet "Leak Testing of Drinking Water Installations with Compressed Air, Inert Gas or Water" (January 2011) of the German Central Association for Sanitary, Heating and Air Conditioning (ZVSHK) and for pressure testing of other pipe systems and vessels.

### Pneumatic pump

Pneumatic pump for controlled filling of all types of vessels with compressed air  $\leq 0.8$  MPa/8 bar/116 psi, with automatic switch-off on reaching the preset air pressure, e.g. for pumping up expansion vessels or tyres.

### Operation of pneumatic tools

Connection for pneumatic tools up to an air requirement  $\leq 230$  NI/min, adjustable, for adaptation to the pneumatic tool being used. Pressure gauge for controlling the air pressure supplied by the compressed air tank. Pneumatic hose with quick coupling DN 7.2, as an accessory.

### Logging

Results of the flushing and test programs are saved with date, time and log number in the selected language and can be transferred to USB stick or printer for documentation. Printer as an accessory. Additions to saved data, e.g. customer name, project number, tester, are possible on external devices (e.g. PC, laptop, tablet-PC, Smartphone).



# REMS Multi-Push SL/SLW

Electronic flushing and pressure testing unit with compressor

## Supply format

**REMS Multi-Push SL Set.** Electronic flushing and pressure testing unit with oil-free compressor. For flushing with water or a water/air mixture, disinfection, cleaning, preservation of pipe systems, e.g. for desilting, cleaning and preservation of radiators and area heating systems, flushing and disinfection of drinking water installations, for pressure testing of pipe systems and vessels with compressed air, as a pneumatic pump for controlled filling of all types of vessels with compressed air  $p \leq 0.8 \text{ MPa}/8 \text{ bar}/116 \text{ psi}$ , and for operation of pneumatic tools  $\leq 230 \text{ NI}/\text{min}$ . Input and control unit. Piston compressor with crank drive, capacitor motor 230V, 50 Hz, 1,500 W, person circuit breaker (PRCD). Mobile tubular steel frame. Fastenings for water inputs and outputs of the REMS Multi-Push. Two  $\varnothing 1"$  suction/pressure hoses, with fabric inlay, 1.5 m long, with 1" hose screw fittings, with caps. One  $\varnothing 8 \text{ mm}$  compressed air hose, 1.5 m long, with quick coupling DN 5 and G  $\frac{1}{2}"$  hose screw fitting, for pressure testing with compressed air. Connecting hose compressor/water connections, 0.6 m long, with quick coupling DN 7.2 and 1" hose screw fitting, 1" double nipple, for blowing out water remains from REMS Multi-Push and suction/pressure hoses at the end of work. Without disinfection unit, without cleaning and preservation unit. In a carton

	Art.-No.	€
	115610R220	<b>3.108,81</b>

Other voltages on request.



Info



## Supply format

**REMS Multi-Push SLW Set.** Same as REMS Multi-Push SL Set, Art. No. 115610, additionally with hydro-pneumatic water pump for hydrostatic pressure testing of drinking water installations with water in accordance with EN 806-4:2010, test method A, B or C or test method B and for pressure testing of other pipe systems and vessels. One high-pressure hose  $\varnothing \frac{1}{2}"$ , 1.5 m long, with  $\frac{1}{2}"$  hose screw fittings, with caps. In a carton.

	Art.-No.	€
	115611R220	<b>4.011,87</b>

Other voltages on request.



Info



## Accessories

Description	Art.-No.	€
<b>Fine filter with fine filter cartridge 90 <math>\mu\text{m}</math></b> , washable, with large dirt collection vessel	115609R	<b>123,52</b>
<b>Fine filter cartridge 90 <math>\mu\text{m}</math></b> , for fine filter with fine filter cartridge 90 $\mu\text{m}$	043054	<b>40,07</b>
<b>Pressure gauge, <math>p \leq 6 \text{ MPa}/60 \text{ bar}/870 \text{ psi}</math></b> , for pressure and leak testing of pipe systems and vessels up to 6 MPa/60 bar/870 psi.	115140	<b>111,38</b>
<b>Fine scaled pressure gauge, <math>p \leq 1.6 \text{ MPa}/16 \text{ bar}/232 \text{ psi}</math></b> , for pressure and leak testing of pipe systems and vessels up to 1.6 MPa/16 bar/232 psi. CL 1.0.	115045	<b>79,61</b>
<b>Fine scaled pressure gauge, <math>p \leq 250 \text{ hPa}/250 \text{ mbar}/3.6 \text{ psi}</math></b> , for pressure and leak testing of pipe systems and vessels up to 250 hPa/250 mbar/3.6 psi. CL 1.6.	047069	<b>240,19</b>
<b>Compressed air hose <math>\varnothing 14 \text{ mm}</math></b> , 1.5 m long, with quick couplings DN 7.2 (plug, socket), for connecting pneumatic tools	115621R	<b>61,97</b>
<b>Compressed air hose <math>\varnothing 8 \text{ mm}</math></b> , 7 m long, with quick coupling DN 5 (plug) and G $\frac{1}{2}"$ hose screw fitting, for pressure testing with compressed air.	115667R	<b>64,88</b>
<b>Compressed air hose <math>\varnothing 8 \text{ mm}</math></b> , 1.5 m long, with quick coupling DN 5 (plug, socket) for gas testing with compressed air.	115747R	<b>67,26</b>
<b>High-pressure hose <math>\varnothing \frac{1}{2}"</math></b> , 7 m long, with G $\frac{1}{2}"$ hose screw fittings, with caps, for pressure testing of pipe systems and vessels with water with REMS Multi-Push SLW.	115661R	<b>128,71</b>
<b><math>\varnothing 1"</math> suction/pressure hose</b> , with fabric inlay, 1.5 m long, with G 1" screw fittings for flushing, disinfection, cleaning, preservation and pressure testing with water.	115633R	<b>59,27</b>
<b>Double nipple 1"</b> , for connecting 2 suction/pressure hoses and blowing out the suction/pressure hoses	045159	<b>10,38</b>



# REMS Multi-Push SL/SLW

Electronic flushing and pressure testing unit with compressor

Description	Art.-No.	€
<b>Printer</b> for printing the stored results of the flushing and test programs, 1 roll of paper, USB connecting cable, power supply/charger Ni-Mh 100–240 V, 50–60 Hz, 3 W	115604R	<b>508,62</b>
<b>Paper roll</b> , pack of 5 for printer	090015R	<b>18,89</b>
<b>Case</b> with inlays for printer, paper rolls and other accessories	115703R	<b>70,58</b>
<b>REMS V-Jet TW</b> , disinfection unit for drinking water installations, for feeding dosing solution for disinfection	115602R	<b>304,13</b>
<b>REMS Peroxi Color</b> , 1 l bottle of REMS Peroxi dosing solution for disinfection of approx. 100 l line volume, 20 ml bottle of red REMS Color dye for dyeing the dosing solution for filling and wash-out check, pipette for checking the effectiveness of the dosing solution.	115605R	<b>82,00</b>
<b>Test strips H<sub>2</sub>O<sub>2</sub> 0–1,000 mg/l, pack of 100</b> , for checking the concentration of the disinfection solution	091072	<b>71,21</b>
<b>Test strips H<sub>2</sub>O<sub>2</sub> 0–50 mg/l, pack of 100</b> , for checking the complete flushing out of the disinfection solution after disinfection	091073	<b>71,21</b>
<b>REMS V-Jet H</b> , cleaning and preservation unit for radiators and area heating systems, for feeding cleaner and corrosion protection.	115612R	<b>304,13</b>
<b>REMS CleanH</b> 1 l bottle of cleaner for radiators and area heating systems, dyed green for filling and wash-out check, for approx. 100 l line volume.	115607R	<b>57,09</b>
<b>REMS NoCor</b> 1 l bottle of corrosion protection for preservation of radiators and area heating systems, dyed blue for filling check, for approx. 100 l line volume.	115608R	<b>61,24</b>
<b>Hood</b> for protecting the machine during transport and storage	115677R	<b>39,24</b>
<b>XL-Boxx system case</b> for hoses	579600RMP	<b>198,26</b>



## REMS CleanM

Machine cleaner

Highly effective machine cleaner for fast, reliable removal of oily and greasy soiling of all kinds. For cleaning and degreasing machines, tools etc. For trade and industry.

**REMS CleanM – you can't get cleaner than that. Very high cleaning effect.**

Especially for fast, reliable removal of oily and greasy soiling of all kinds. Easily biodegradable according to OECD 302 B. Free from substances classified as harmful to the environment.

Universal cleaner for trade and industry. For cleaning and degreasing machines and tools.

Can also be used for removing lime scale.

REMS CleanM spray bottle without propellant.

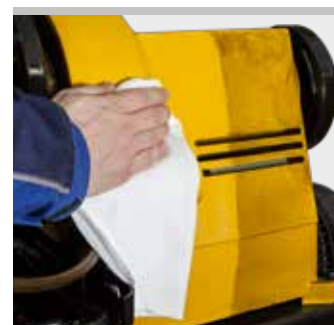

German Quality Product



Info



### Supply format

**REMS CleanM.** Highly effective machine cleaner for fast and reliable removal of oily and greasy soiling. For cleaning and degreasing machines, tools etc.

Packing	Art.-No.	€
500 ml spray bottle	140119R	<b>19,41</b>

Powerful electric filling and flushing unit for fast, easy filling, flushing and venting of closed systems. Ideal for solar power systems, ground heat systems and underfloor/wall heating.

Tank volume 30 litres

### REMS Solar-Push K 60 with centrifugal pump

Transport capacity at 40 m pumping head 16 l/min

Transport volume ≤ 36 l/min

Transport pressure ≤ 0.55 MPa/5.5 bar/80 psi

Temperature of the transported media (constant load) ≤ 60°C

pH value of the transported media 6.5 – 9.5

### REMS Solar-Push I 80 with impeller pump

Transport capacity at 40 m pumping head 18 l/min

Transport volume ≤ 27 l/min

Transport pressure ≤ 0.65 MPa/6.5 bar/94 psi

Temperature of the transported media (constant load) ≤ 80°C

pH value of the transported media 6.5 – 9.5

Media transported: heat transfer liquids, antifreeze, water, aqueous solutions, emulsions

## REMS Solar-Push – filling, flushing and venting in one action. Self priming. High transport capacity.

### System advantage

Filling, flushing and venting in one action. Ideal for solar power systems, ground heat systems and underfloor/wall heating. Also for filling tanks.

### Design

Powerful, electric filling and flushing unit on stable, mobile tubular steel frame for secure standing. 2 large, air-filled tyres for easy transport in rugged building site conditions. Practical hose holder. Low weight, REMS Solar-Push I only 19 kg, REMS Solar-Push K only 20 kg. Sturdy plastic tank to hold 30 litres, made of UV-stabilised PE, with filling level indicator, removable, for easy cleaning, with large opening for easy filling. Practical screw cap for fast opening and closing. Return connection 3/4" with immersion pipe avoids foaming of the transport medium when it enters the plastic tank. Stop tap for easy cleaning and easy changing of the plastic tank when using different transport media. Two practical handles for easy carrying of the plastic tank. High temperature-resistant connecting hose between plastic tank and pump. Fine filter in the suction line with large viewing window for easy recognition of residue air in the circuit as well as emitted contamination, e.g. chips, solder and welding residue.

### REMS Solar-Push K 60

Self-suction centrifugal pump, suitable for different transport media, e.g. heat transfer liquids, antifreeze, water, aqueous solutions, emulsions. With proven, powerful condenser motor with quiet running, 940 W, on/off switch. High transport volume 36 l/min for fast filling, efficient flushing and venting of closed systems and for filling tanks. Pressure relief valve for simple pressure relief in the pressure hose at the end of operation, as an accessory. For continuous load ≤ 60°C. 2 pieces flexible, transparent PVC fabric hoses 1/2" T60, for pressure and return lines, each 3 m long, with 3/4" hose screw fittings, temperature-resistant ≤ 60°C.

### REMS Solar-Push I 80

Dry self-suction impeller pump with special impeller, suitable for different transport media, e.g. heat transfer liquids, antifreeze, water, aqueous solutions, emulsions. With proven, powerful condenser motor with quiet running, 1000 W, on/off switch. High transport volume 27 l/min for fast filling, efficient flushing and venting of closed systems and for filling tanks. Pressure relief valve for simple pressure relief in the pressure hose at the end of operation. For continuous load ≤ 80°C. 2 flexible EPDM fabric hoses 1/2" T100 (synthetic rubber) for pressure and return lines, each 3 m long, with 3/4" hose screw fittings, high temperature-resistant ≤ 100°C.

### Extensive accessories

Shut-off valve for closing the pressure or return line, e.g. during transport. Fine filter with fine filter bag 70 µm, consisting of a screw cap with return line connection for return line with 3/4" union, adapter and fine filter bag 70 µm, or fine filter with fine filter cartridge 90 µm, washable, with large dirt collection vessel, for return line with 3/4" connection for flushing underfloor heating/wall radiators and clearing sludge. Flow direction changeover valve complete with EPDM fabric hose 1/2" T100, for flushing underfloor heating/wall radiators and effective clearance of sludge by pressure surges when flow direction changes. Changeover valve for alternative suction of the transport medium from another tank, e.g. for larger volumes.



German Quality Product



K 60



I 80

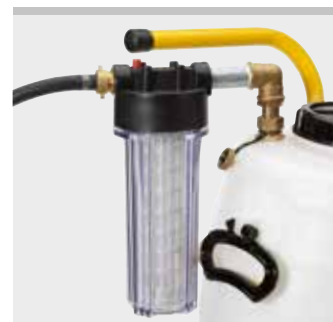

## Supply format

**REMS Solar-Push K 60.** Electric filling and flushing unit for fast, easy filling, flushing and venting of closed systems. Transport volume ≤ 36 l/min, tank volume 30 l. With centrifugal pump, temperature-resistant for continuous load ≤ 60°C. Transport pressure ≤ 0.55 MPa/5.5 bar/80 psi. Condenser motor 230 V, 50 Hz, 940 W. 2 pieces flexible, transparent PVC fabric hoses ½" T60, each 3 m long, temperature-resistant ≤ 60°C. On sturdy tubular steel frame with air-filled wheels. In box.

Art.-No.	€
115312R220	<b>933,16</b>

Other voltages on request.

## Supply format

**REMS Solar-Push I 80.** Electric filling and flushing unit for fast, easy filling, flushing and venting of closed systems. Transport volume ≤ 27 l/min, tank volume 30 l. With impeller pump, temperature-resistant for continuous load ≤ 80°C. Transport pressure ≤ 0.65 MPa/6.5 bar/94 psi. Transport capacity at 40 m transport height 10 l/min. Condenser motor 230 V, 50 Hz, 1000 W. Pressure relief valve. 2 pieces flexible, EPDM fabric hoses ½" T100, each 3 m long, high temperature-resistant ≤ 100°C. On sturdy tubular steel frame with air-filled wheels. In box.

Art.-No.	€
115311R220	<b>1.140,76</b>

Other voltages on request.



Info







## Accessories

Description	Art.-No.	€
<b>PVC fabric hose ½" T60</b> for pressure or return line, 3 m long, with ¾" hose screw fittings, temperature-resistant ≤ 60°C.	115314R	<b>43,08</b>
<b>EPDM fabric hose ½" T100</b> for pressure or return line, 3 m long, with ¾" hose screw fittings, high temperature-resistant ≤ 100°C	115315R	<b>57,61</b>
<b>EPDM fabric hose ½" T165</b> for pressure or return line, 3 m long, with ¾" hose screw fittings, high temperature-resistant ≤ 165°C	115319R	<b>210,71</b>
<b>¾" shut-off valve</b> for closing the pressure or return line, e.g. during transport.	115324R	<b>52,11</b>
<b>30 l plastic tank</b> made of UV-stabilised PE.	115375R	<b>165,04</b>
<b>Pressure relief valve</b> for Solar-Push K 60.	115217R	<b>74,11</b>
<b>Fine filter with fine filter bag 70 µm</b> , consisting of a screw cap with return line connection for return line with ¾" union, adapter, 1 file filter bag 70 µm, for flushing underfloor heating/wall radiators and clearing sludge	115220	<b>104,84</b>
<b>Fine filter bag 70 µm (pack of 10)</b> , fine file filter with fine filter bag 70 µm	115221R10	<b>88,96</b>
<b>Fine filter with fine filter cartridge 90 µm</b> , washable, with large dirt collection vessel, for return line with ¾" union, for flushing underfloor heating/wall radiators and clearing sludge	115323R	<b>220,06</b>
<b>Fine filter cartridge 90 µm</b> , for fine filter with fine filter cartridge 90 µm	043054	<b>40,07</b>
<b>Flow direction changeover valve</b> complete with EPDM fabric hose ½" T100, for flushing underfloor heating/wall radiators and effective clearance of sludge by pressure surges when flow direction changes	115326R	<b>291,68</b>
<b>Changeover valve</b> for alternative suction of the transport medium from another tank, e.g. for larger volumes.	115325R	<b>86,98</b>





# Bending

	<b>Single-hand tube bender</b>	<b>128</b>
	<b>Oil-hydraulic hand pipe bender</b>	<b>130</b>
	<b>Cordless electro-hydraulic tube bender</b>	<b>132</b>
	<b>Oil-hydraulic pipe bender</b>	<b>134</b>
	<b>Electric pipe and tube bender</b>	<b>136</b>
	<b>Cordless tube bender</b>	<b>140</b>
	<b>Hand tube bender</b>	<b>142</b>

Practical one-hand pipe bender for dimensionally accurate bending of pipes up to 90°. Ideal for on-site work. For trade and industry. For the building site and the workshop.

Soft copper pipes, also thin-walled	Ø 10–22 mm Ø 3/8–7/8" s ≤ 1 mm
Coated soft copper tubes	Ø 10–18 mm Ø 3/8–5/8" s ≤ 1 mm
Soft, coated carbon steel pipes of the pressfitting systems	Ø 12–18 mm s ≤ 1.2 mm
Soft precision steel tubes	Ø 10–18 mm s ≤ 1 mm
Multi-layer composite tubes	Ø 14–32 mm

**REMS Swing – bending tubes where they are installed. Ultra light, ultra small, ultra handy. Universally usable for many pipe types. Ultra fast operation by practical multifunction lever for fast in-feed and fast return. Proven, reliable ratchet feed. Ideal also for coated tubes.**

### Universal use

For sanitary, heating, air conditioning, refrigerating and hydraulic applications. Also for copper thin-walled heating tubes according to EN 1057 and for tubes of pressfitting systems.

### Cost advantage

Bender recovered after a few bends through savings on fittings. No costs for fittings, storage, procurement. Savings in soldering joints, pressing joints and working hours. Higher safety thanks to fewer pipe joints.

### Design

Compact, job site-proven. Handy and light, drive unit only 0.9 kg. Can be used anywhere, free-hand, in confined areas. Easy, quick working, e.g. Ø 22 mm copper pipe bend in just 9 s. Marked bending formers for exact bending. Overbend, tier bend possible. Easy and rapid changing of bending formers. Back former support S Ø 10–26 mm, rotatable according to the size of the pipe to be bent, with back formers for pipes Ø 10–26 mm, 3/8–7/8". Back former support Ø 32 mm with back formers for pipe Ø 32 mm. Device for reverse bending on laid pipes up to Ø 22 mm, 7/8", as accessory.

### Bending formers and sliding pieces

In high-strength, high-slide, glass-fibre reinforced polyamide. Angle scale on each bending former for dimensionally accurate bending. See table on page 129 for bending formers. UP bending formers with smaller bending radii for Uponor Uni Pipe PLUS composite pipes, see below.

### Drive

Sturdy drive unit with proven, reliable ratchet feed for the complete work range up to Ø 32 mm. Practical multi-function lever for fast in-feed and fast return saves time and effort.

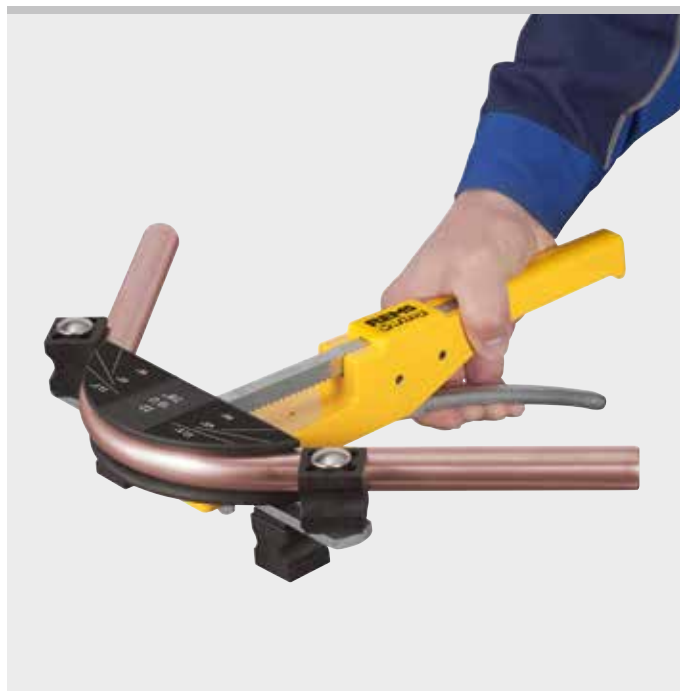

German Quality Product



Info



### Supply format

**REMS Swing UP Set.** Single-hand tube bender Ø 16–32 mm, up to 90°. for Uponor Uni Pipe PLUS composite pipes Ø 16–32 mm. With UP drive unit, UP bending formers with smaller bending radii, UP back former supports Ø 16–32 mm with back formers, in a sturdy steel box/case.

Description mm	Art.-No.	€
Set 16 + 20 + 25 + 32	153030R	550,14

### Accessories

Description	Art.-No.	€
<b>REMS Swing UP</b> drive unit	153300R	153,62
<b>UP back former support Ø 16–32 mm</b> with back formers for pipes Ø 16–32 mm	153307R	97,26
<b>UP bending former Ø 16 mm</b> , bending radius 32 mm	153303R	46,61
<b>UP bending former UP Ø 20 mm</b> , Biegeradius 40 mm	153304R	46,61
<b>UP bending former UP Ø 25 mm</b> , Biegeradius 62,5 mm	153305R	46,61
<b>UP bending former UP Ø 32 mm</b> , Biegeradius 80 mm	153306R	151,55
<b>Steel case with inlay</b>	153265R	55,01





### Supply format

**REMS Swing Set.** Single-hand tube bender Ø 10–32 mm, Ø 3/8–7/8", up to 90°. Soft copper pipes Ø 10–22 mm, Ø 3/8–7/8", s ≤ 1 mm, soft, coated copper pipes Ø 10–18 mm, Ø 3/8–5/8", s ≤ 1 mm, soft, coated carbon steel pipes of the pressfitting systems Ø 12–18 mm, s ≤ 1.2 mm, soft precision steel pipes Ø 10–18 mm, s ≤ 1 mm, composite tubes Ø 14–32 mm. Up to Ø 26 mm with drive unit, bending formers, back former supports S Ø 10–26 mm with back formers, in a sturdy steel box/case. Up to Ø 32 mm with drive unit, bending formers, 2 back former supports Ø 10–26 mm and Ø 32 mm with back formers, in a sturdy steel case.

Description mm	inch	Art.-No.	€
<b>Set 12 + 15 + 18 + 22</b>	1/2 + 5/8 + 3/4 + 7/8"	153025R	<b>359,15</b>
<b>Set 10 + 12 + 15 + 18 + 22</b>	3/8 + 1/2 + 5/8 + 3/4 + 7/8"	153021R	<b>375,76</b>
<b>Set 12 + 14 + 16 + 18 + 22</b>	1/2 + 3/4 + 7/8"	153020R	<b>375,76</b>
<b>Set 14 + 16 + 20 + 25/26</b>		153026R	<b>359,15</b>
<b>Set 14 + 16 + 18 + 20 + 25/26</b>		153022R	<b>375,76</b>
<b>Set 16 + 20 + 25/26 + 32</b>		153029R	<b>570,90</b>
<b>Set Allround 22</b>			
<b>10 + 12 + 14 + 15 + 16 + 17 + 18 + 20 + 22</b>	3/8 + 1/2 + 5/8 + 3/4 + 7/8"	153027R	<b>482,67</b>
<b>Set 16 + 18 + 20 + 25/26 + 32</b>		153023R	<b>607,23</b>
<b>Set Allround 32</b>			
<b>10 + 12 + 14 + 15 + 16 + 17 + 18 + 20 + 22 + 25/26 + 32</b>	3/8 + 1/2 + 5/8 + 3/4 + 7/8"	153028R	<b>679,89</b>



### Accessories

Description	Art.-No.	€
<b>REMS Swing drive unit</b>	153100R	<b>153,62</b>
<b>Back former support S Ø 10–26 mm with back formers</b> for pipes Ø 10–26 mm, 3/8–7/8"	153125RX	<b>61,97</b>
<b>Back former support Ø 32 mm with back formers</b> for pipe Ø 32 mm	153115RX2	<b>133,38</b>
<b>Device for reverse bending</b> on laid pipes up to Ø 26 mm, 7/8"	153140	<b>154,66</b>
<b>Steel case with inlay</b>	153265R	<b>55,01</b>
<b>Case with inlay</b>	153270R	<b>107,95</b>

Bending former for tubes Ø mm/inch	Bending radius <sup>1)</sup> mm	suitable for					Art.-No.	€
		Cu	Cu-U	St 10305-U	St 10305	V		
10, 3/8"	30	●			●		153155R	<b>32,07</b>
12, 10 U, 1/2"	36	●	●		●		153160R	<b>32,07</b>
14, 12 U	50	●		●	●	●	153170R	<b>32,07</b>
15, 12 U, 5/8"	55	●	●		●		153175R	<b>32,07</b>
16, 14 U	55	●	●		●	●	153180R	<b>32,07</b>
17, 15 U	60			●		●	153185R	<b>32,07</b>
18, 14 U, 15 U, 16 U, 3/4"	72	●	●		●	●	153190R	<b>32,07</b>
20, 18 U	79	●	●	●		●	153195R	<b>32,07</b>
22, 18 U, 7/8"	86	●	●				153200R	<b>32,07</b>
25, 26	88					●	153205R	<b>32,07</b>
32	128					●	153210R	<b>60,20</b>

<sup>1)</sup> Bending radius mm at the neutral axis of the bend (DVGW GW 392)

Cu: soft copper tubes, also thin-wall  
 St 10305-U: soft, coated carbon steel pipes of the pressfitting systems EN 10305-3  
 St 10305: soft precision steel pipes EN 10305-1, EN 10305-2, EN 10305-3  
 U: coated  
 V: multi-layer composite tubes of pressfitting systems



Effort-saving, oil-hydraulic hand pipe bender for dimensionally accurate bending of pipes up to 90°. Ideal for on-site work. For trade and industry. For the building site and the workshop.

Soft copper pipes, also thin-walled	Ø 10 – 22 mm Ø 3/8 – 7/8" s ≤ 1 mm
Coated soft copper tubes	Ø 10 – 18 mm Ø 3/8 – 5/8" s ≤ 1 mm
Pipes of press fitting systems made of: stainless steel, nickel steel	Ø 15 – 22 mm s ≤ 1.2 mm
Soft, coated carbon steel	Ø 12 – 18 mm s ≤ 1.2 mm
Soft precision steel tubes	Ø 10 – 22 mm s ≤ 1.5 mm
Multi-layer composite tubes	Ø 14 – 32 mm

**REMS Hydro-Swing – bending tubes where they are installed. Universally usable for many pipe types. Effortless working due to oil-hydraulic force transmission.**

### Universal use

For sanitary, heating, air conditioning, refrigerating and hydraulic applications. Also for copper thin-walled heating tubes according to EN 1057 and for tubes of pressfitting systems.

### Cost advantage

Bender recovered after a few bends through savings on fittings. No costs for fittings, storage, procurement. Savings in soldering joints, pressing joints and working hours. Higher safety thanks to fewer pipe joints.

### Design

Robust, compact drive unit with closed, maintenance-free hydraulic system. Handy and light, only 2.4 kg. Can be used anywhere, even in confined spaces. Easy, quick working, e.g. Ø 22 mm copper pipe bend in just 18 s. Marked bending formers for exact bending. Overbend, tier bend possible. Easy and rapid changing of bending formers. Back former support H-S Ø 10 – 26 mm, rotatable according to the size of the pipe to be bent, with back formers for pipes Ø 10 – 26 mm, 3/8 – 7/8". Back former support Ø 32 mm with back formers for pipes Ø 32 mm. Device H-S for reverse bending on laid pipes up to Ø 26 mm, 3/8", as accessory.

### Bending formers and sliding pieces

Bending formers and back formers made of high strength, high sliding, glass fibre reinforced polyamide or aluminium bending formers. Angle scale on each bending former for dimensionally accurate bending. See table on page 131 for bending formers.

### Drive

Oil-hydraulic drive unit with hydraulic cylinder made from high-quality, rolled hydraulic tube. Ergonomically designed thrust lever for strength saving pressure build-up with manual hydraulic pump. Reliable hydraulic thrust with overload protection in the foremost piston position and overpressure valves for safe working.

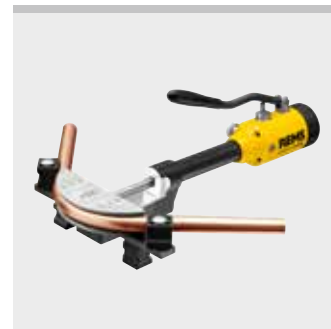
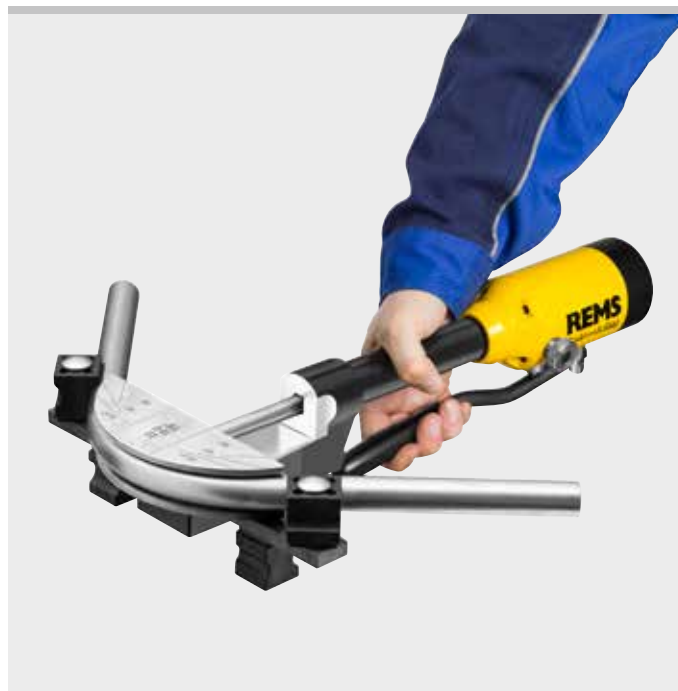

German Quality Product



Info

# REMS Hydro-Swing

Oil-hydraulic hand pipe bender

## Supply format

**REMS Hydro-Swing Set.** Oil-hydraulic hand pipe bender Ø 10–32 mm, Ø 3/8–7/8", up to 90°. Soft copper pipes Ø 10–22 mm, Ø 3/8–7/8", s ≤ 1 mm, soft, coated copper pipes Ø 10–18 mm, Ø 3/8–5/8", s ≤ 1 mm, pipes of the press fitting systems made of soft, coated carbon steel Ø 12–18 mm, s ≤ 1.2 mm, soft precision steel pipes Ø 10–18 mm, s ≤ 1.5 mm, composite tubes Ø 14–32 mm. Up to Ø 26 mm with drive unit, polyamide bending formers, back former support H-S Ø 10–26 mm with back formers, in a sturdy case. Up to Ø 32 mm with drive unit, polyamide bending formers, 2 back former supports Ø 10–26 mm and Ø 32 mm with back formers, in a sturdy case.

Description mm	inch	Art.-No.	€
<b>Set 12 + 15 + 18 + 22</b>	1/2 + 5/8 + 3/4 + 7/8"	153525RX	<b>699,61</b>
<b>Set 10 + 12 + 15 + 18 + 22</b>	3/8 + 1/2 + 5/8 + 3/4 + 7/8"	153521RX	<b>725,56</b>
<b>Set 12 + 14 + 16 + 18 + 22</b>	1/2 + 3/4 + 7/8"	153520RX	<b>725,56</b>
<b>Set 14 + 16 + 20 + 25/26</b>		153526R	<b>699,61</b>
<b>Set 14 + 16 + 18 + 20 + 25/26</b>		153522R	<b>725,56</b>
<b>Set 16 + 20 + 25/26 + 32</b>		153529R	<b>777,46</b>
<b>Set Allround 22</b>			
<b>10 + 12 + 14 + 15 + 16 + 17 + 18 + 20 + 22</b>	3/8 + 1/2 + 5/8 + 3/4 + 7/8"	153527RX	<b>755,66</b>
<b>Set 16 + 18 + 20 + 25/26 + 32</b>		153523R	<b>801,34</b>
<b>Set Allround 32</b>			
<b>10 + 12 + 14 + 15 + 16 + 17 + 18 + 20 + 22 + 25/26 + 32</b>	3/8 + 1/2 + 5/8 + 3/4 + 7/8"	153528RX	<b>857,39</b>



## Supply format

**REMS Hydro-Swing INOX Set.** REMS Hydro-Swing with aluminium bending formers, especially also for Geberit Mapress Stainless Steel (EN 10088, 1.4401), Geberit Mapress Stainless Steel (EN 10088, 1.4521, nickel-free), Geberit Mapress Carbon Steel (EN 10305-3, 1.0034 (E195)), Viega Sanpress (EN 10088, 1.4401), Viega Prestabo (EN 10305-3, 1.0308 (E235)).

Description mm	Art.-No.	€
<b>Set 15 + 18 + 22</b>	153510R	<b>773,31</b>

## Accessories

Description	Art.-No.	€
<b>REMS Hydro-Swing drive unit</b>	153500R	<b>569,86</b>
<b>Back former support H-S Ø 10–26 mm</b> with back formers for pipe Ø 10–26 mm, 3/8–7/8"	153501R	<b>69,34</b>
<b>Back former support Ø 32 mm</b> with back formers for pipe Ø 32 mm	153115RX2	<b>133,38</b>
<b>Device H-S for reverse bending</b> on laid pipes up to Ø 26 mm, 3/8"	153450R	<b>237,70</b>
<b>Case with inlay</b>	153570R	<b>107,95</b>

Bending former for tubes Ø mm/inch	Bending radius <sup>1)</sup> mm	suitable for					Art.-No.	€
		Cu	Cu-U	St 10217	St 10305	St 10305-U		
10, 3/8"	30	●			●		153155R	<b>32,07</b>
12, 10 U, 1/2"	36	●	●		●		153160R	<b>32,07</b>
14, 12 U	50	●			●	●	153170R	<b>32,07</b>
15, 12 U, 5/8" <sup>2)</sup>	55	●	●	●	●		153531R	<b>73,49</b>
15, 12 U, 3/8"	55	●	●		●		153175R	<b>32,07</b>
16, 14 U	55	●	●		●	●	153180R	<b>32,07</b>
17, 15 U	60					●	153185R	<b>32,07</b>
18, 14 U, 15 U, 16 U, 3/4" <sup>2)</sup>	72	●	●	●	●	●	153532R	<b>73,49</b>
18, 14 U, 15 U, 16 U, 3/4"	72	●	●		●	●	153190R	<b>32,07</b>
20, 18 U	79	●	●		●	●	153195R	<b>32,07</b>
22, 18 U, 7/8" <sup>2)</sup>	86	●	●	●	●		153540R	<b>73,49</b>
22, 18 U, 7/8"	86	●	●				153200R	<b>32,07</b>
25, 26	88					●	153205R	<b>32,07</b>
32	128					●	153210R	<b>60,20</b>

<sup>1)</sup> Bending radius mm at the neutral axis of the bend (DVGW GW 392)

<sup>2)</sup> Aluminium bending formers

Cu: soft copper tubes, also thin-wall, EN 1057  
 St 10217: stainless, nickel steel pipes of the press fitting systems EN 10217-7, EN 10312, series 2, material 1.4401  
 St 10305: soft precision steel pipes EN 10305-1, EN 10305-2, EN 10305-3  
 St 10305-U: soft, coated carbon steel pipes of the pressfitting systems EN 10305-3  
 U: coated  
 V: multi-layer composite tubes of pressfitting systems

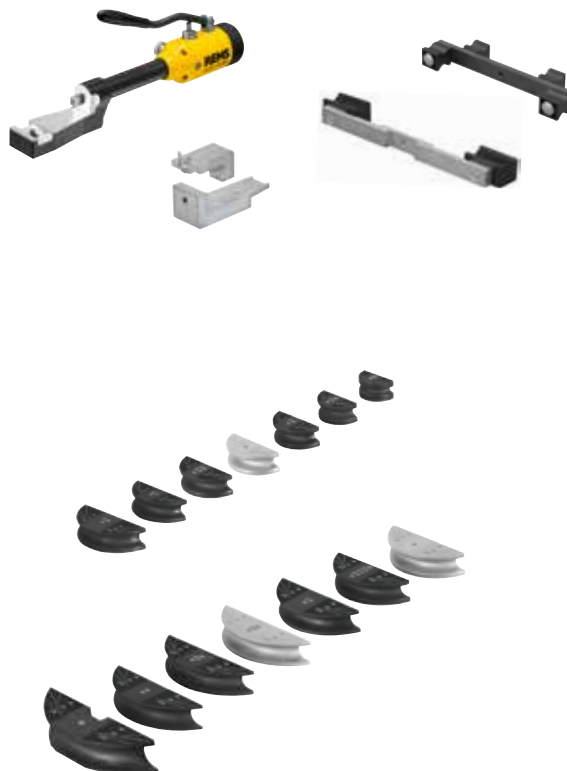

# REMS Hydro-Swing 22V

Cordless tube bender

Universal, mobile, handy electric tool for dimensionally accurate bending of pipes up to 90°. Ideal for on-site work. For trade and industry. For the building site and the workshop. Li-Ion 22V Technology. For battery and corded operation.

Soft copper pipes, also thin-walled	Ø 10 – 22 mm Ø 3/8 – 7/8" s ≤ 1 mm
Coated soft copper tubes	Ø 10 – 18 mm Ø 3/8 – 5/8" s ≤ 1 mm
Pipes of press fitting systems made of: stainless steel, nickel steel	Ø 15 – 22 mm s ≤ 1.2 mm
Soft, coated carbon steel	Ø 12 – 18 mm s ≤ 1.2 mm
Soft precision steel tubes	Ø 10 – 22 mm s ≤ 1.5 mm
Multi-layer composite tubes	Ø 14 – 32 mm

**REMS Hydro-Swing 22V – bending tubes where they are installed. Mobile, handy, light. Universally usable for many pipe types. Li-Ion 21.6V, 2.5Ah battery, for approx. 110 stainless steel pipe bends of the Ø 22 mm press fitting systems with one battery charge\*.**

## Universal use

For sanitary, heating, air conditioning, refrigerating and hydraulic applications. Also for copper thin-walled heating tubes according to EN 1057 and for tubes of pressfitting systems.

## Cost advantage

Cordless tube bender recovered after a few bends through savings on fittings. No costs for fittings, storage, procurement. Savings in soldering joints, pressing joints and working hours. Higher safety thanks to fewer pipe joints.

## Design

Robust, compact drive unit with closed, maintenance-free hydraulic system. Mobile, handy, light. Drive machine with battery pack weights only 3.0 kg. Can be used anywhere, even in confined spaces. Easy, quick working, e.g. Ø 22 mm stainless steel pipe bend in just 8 s. Marked bending formers for exact bending. Overbend, tier bend possible. Easy and rapid changing of bending formers. Back former support H-S Ø 10 – 26 mm, rotatable according to the size of the pipe to be bent, with back formers for pipes Ø 10 – 26 mm, 3/8 – 7/8". Back former support Ø 32 mm with back formers for pipes Ø 32 mm. LED work light for illuminating the work place. Device H-S for reverse bending on laid pipes up to Ø 26 mm, 7/8", as accessory.

## Bending formers and sliding pieces

Bending formers and back formers made of high strength, high sliding, glass fibre reinforced polyamide or aluminium bending formers. Angle scale on each bending former for dimensionally accurate bending. See table on page 133 for bending formers.

## Drive

Tons of thrust for crease-free bending within seconds. Thrust force 9 kN. Powerful electro-hydraulic drive with powerful battery motor 21.6 V, 380 W output, robust planetary gear, eccentric reciprocating pump and compact high power hydraulic system. Safety tip switch.

## Battery or mains operation

Li-Ion 22V Technology. Highly resistant Li-Ion 21.6V battery with 2.5, 4.4, 5.0 or 9.0Ah capacity, for long service life. Light and powerful. Li-Ion 21.6V, 2.5Ah battery for approx. 110 pipe bends, 4.4Ah for approx. 190 pipe bends, 5.0Ah for approx. 220 pipe bends, 9.0Ah for approx. 396 pipe bends of the stainless steel Ø 22 mm press fitting systems with one battery charge\*. Graduated charging status check by coloured LEDs. Operating temperature range – 10 to + 60 °C. No memory effect for maximum battery power. Rapid charger 100 – 240V, 90W. Rapid charger 100 – 240V, 290W, for shorter charging times, as accessory. Voltage supply 220 – 240V/21.6V, 15A output, for mains operation instead of Li-Ion battery 21.6 V, as accessory.

## Supply format

**REMS Hydro-Swing 22V INOX Set.** REMS Hydro-Swing 22V with aluminium bending formers, especially also for Geberit Mapress Stainless Steel (EN 10088, 1.4401), Geberit Mapress Stainless Steel (EN 10088, 1.4521, nickel-free), Geberit Mapress Carbon Steel (EN 10305-3, 1.0034 (E195)), Viega Sanpress (EN 10088, 1.4401), Viega Prestabo (EN 10305-3, 1.0308 (E235)).

Description mm	Art.-No.	€
Set 15 + 18 + 22	153419R220	1.483,30

Other voltages on request.

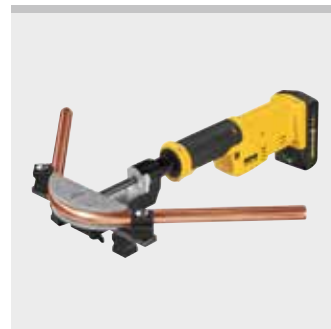

German Quality Product



Info



# REMS Hydro-Swing 22 V

Cordless tube bender

## Supply format

**REMS Hydro-Swing 22 V Set.** Cordless tube bender Ø 10–32 mm, Ø ⅜–⅞", up to 90°. Soft copper pipes Ø 10–22 mm, Ø ⅜–⅞", s ≤ 1 mm, soft, coated copper pipes Ø 10–18 mm, Ø ⅜–⅝", s ≤ 1 mm, pipes of the press fitting systems made of soft, coated carbon steel Ø 12–18 mm, s ≤ 1.2 mm, soft precision steel pipes Ø 10–18 mm, s ≤ 1.5 mm, composite tubes Ø 14–32 mm. Electro-hydraulic drive with powerful battery motor 21.6 V, 380 W, robust planetary gear, eccentric reciprocating pump and compact high power hydraulic system. Safety tip switch. LED work light. Battery Li-Ion 21.6 V, 2.5 Ah, rapid charger 220–240 V or 110 V, 50–60 Hz, 70 W. Up to Ø 26 mm with polyamide bending formers, back former support H-S Ø 10–26 mm with back formers. Up to Ø 32 mm with polyamide bending formers, 2 back former supports Ø 10–26 mm and Ø 32 mm with back formers. In XL-Boxx system case.

Description mm	inch	Art.-No.	€
<b>Set 12 + 15 + 18 + 22</b>	½ + ⅝ + ¾ + ⅞"	153410RX220	<b>1.389,88</b>
<b>Set 10 + 12 + 15 + 18 + 22</b>	⅜ + ½ + ⅝ + ¾ + ⅞"	153411RX220	<b>1.431,40</b>
<b>Set 12 + 14 + 16 + 18 + 22</b>	½ + ⅜ + ⅞"	153412RX220	<b>1.431,40</b>
<b>Set 14 + 16 + 20 + 25/26</b>		153413R220	<b>1.389,88</b>
<b>Set 14 + 16 + 18 + 20 + 25/26</b>		153414R220	<b>1.431,40</b>
<b>Set 16 + 20 + 25/26 + 32</b>		153415R220	<b>1.483,30</b>
<b>Set Allround 22</b>			
<b>10 + 12 + 14 + 15 + 16 + 17 + 18 + 20 + 22</b>	⅜ + ½ + ⅝ + ¾ + ⅞"	153416RX220	<b>1.555,96</b>
<b>Set 16 + 18 + 20 + 25/26 + 32</b>		153417R220	<b>1.587,10</b>
<b>Set Allround 32</b>			
<b>10 + 12 + 14 + 15 + 16 + 17 + 18 + 20 + 22 + 25/26 + 32</b>	⅜ + ½ + ⅝ + ¾ + ⅞"	153418RX220	<b>1.784,32</b>
<b>Basic-Pack (ohne Biegesegmente und Gleitstücke)</b>		153401R220	<b>1.203,04</b>

Other voltages on request.



## Accessories

Description	Art.-No.	€
<b>REMS Hydro-Swing 22 V drive unit, without battery</b>	153400R22	<b>544,95</b>
<b>Back former support H-S Ø 10–26 mm with back formers for pipe Ø 10–26 mm, ⅜–⅞"</b>	153501R	<b>69,34</b>
<b>Back former support Ø 32 mm with back formers for pipe Ø 32 mm</b>	153115RX2	<b>133,38</b>
<b>Device H-S for reverse bending on laid pipes up to Ø 26 mm, ⅞"</b>	153450R	<b>237,70</b>
<b>Battery Li-Ion 21.6 V, 2.5 Ah</b>	571571R22	<b>258,46</b>
<b>Battery Li-Ion 21.6 V, 4.4 Ah</b>	571574R22	<b>372,64</b>
<b>Battery Li-Ion 21.6 V, 5.0 Ah</b>	571581R22	<b>310,36</b>
<b>Battery Li-Ion 21.6 V, 9.0 Ah</b>	571583R22	<b>414,16</b>
<b>Rapid charger 100–240 V, 50–60 Hz, 90 W</b>	571585R220	<b>175,42</b>
<b>Rapid charger 100–240 V, 50–60 Hz, 290 W</b>	571587R220	<b>414,16</b>
<b>Voltage supply 220–240 V/21.6 V, 50–60 Hz, 15 A, for mains operation instead of battery Li-Ion 21.6 V</b>	571567R220	<b>414,16</b>
<b>XL-Boxx system case with inserts</b>	153455R	<b>233,55</b>

**REMS Lumen 2800 22 V, cordless LED flood light, see page 111**

Bending former for tubes Ø mm/inch	Bending radius <sup>1)</sup> mm	suitable for					V		€
		Cu	Cu-U	St 10217	St 10305	St 10305-U			
10, ⅜"	30	●			●			153155R	<b>32,07</b>
12, 10 U, ½"	36	●	●		●			153160R	<b>32,07</b>
14, 12 U	50	●			●	●	●	153170R	<b>32,07</b>
15, 12 U, ⅝" <sup>2)</sup>	55	●	●	●	●			153531R	<b>73,49</b>
15, 12 U, ⅝"	55	●	●		●			153175R	<b>32,07</b>
16, 14 U	55	●	●		●		●	153180R	<b>32,07</b>
17, 15 U	60					●	●	153185R	<b>32,07</b>
18, 14 U, 15 U, 16 U, ¾" <sup>2)</sup>	72	●	●	●	●		●	153532R	<b>73,49</b>
18, 14 U, 15 U, 16 U, ¾"	72	●	●		●			153190R	<b>32,07</b>
20, 18 U	79	●	●			●	●	153195R	<b>32,07</b>
22, 18 U, ⅞" <sup>2)</sup>	86	●	●	●	●			153540R	<b>73,49</b>
22, 18 U, ⅞"	86	●	●					153200R	<b>32,07</b>
25, 26	88						●	153205R	<b>32,07</b>
32	128						●	153210R	<b>60,20</b>

<sup>1)</sup> Bending radius mm at the neutral axis of the bend (DVGW GW 392)

<sup>2)</sup> Aluminium bending formers

- Cu: soft copper tubes, also thin-wall, EN 1057
- St 10217: stainless, nickel steel pipes of the press fitting systems EN 10217-7, EN 10312, series 2, material 1.4401
- St 10305: soft precision steel pipes EN 10305-1, EN 10305-2, EN 10305-3
- St 10305-U: soft, coated carbon steel pipes of the pressfitting systems EN 10305-3
- U: coated
- V: multi-layer composite tubes of pressfitting systems



Robust, oil-hydraulic pipe bender for dimensionally accurate bending of pipes up to 90°. For trade and industry. For the building site and the workshop.

Steel pipes EN 10255	Ø 3/8 – 2"
Multilayer composite tubes	Ø 32 – 75 mm

**REMS Python – extremely easy bending up to Ø 2", 75 mm. Ideal for steel pipes EN 10255 and for multilayer composite tubes of the pressfitting systems. Also for producing level bends in different planes.**

### Universal use

For locksmith work, sanitary and heating installation and machine and plant engineering. Excellently suitable for steel pipes EN 10255 and for multilayer composite tubes of the pressfitting systems.

### System advantage

Only **one** bender drive for the whole working range up to Ø 2", Ø 75 mm. Thus simple, inexpensive stocking. No confusion possible.

### Cost advantage

Pipe bender is amortised after just a few bends by saving on fittings. No costs for fittings, storage, procurement. Saving of welds, press connections and working time. Increased safety due to fewer pipe connections.

### Design

Robust, oil-hydraulic drive unit with closed, maintenance-free hydraulic system. 2 slide roller supports and 2 slide rollers form a closed bending frame for high rigidity and precision when bending. Upper back former support tiltable for easy insertion and removal of the pipe, with marked plug positions for the back formers according to the pipe size to be bent, with angle scale 0 to 90°. Upper slide roller support with laterally adjustable slide roller bearing plate for producing over-bends and level bends according to requirements also in different planes. Can be used anywhere, any time. No setting. Easy, effortless, quick working, e.g. 90° bend Ø 63 mm only 60 s. Tripod as accessory.

### Bending formers and back formers

Bending formers St for steel pipes, form and pressure stable, made of highly resistant spheroidal iron. Bending formers V for multilayer composite tubes, form and pressure stable, made of torsion-free shell-cast aluminium. See page 135. Marking on every bending former for dimensionally accurate bending. Angle gauge with angle scale 0 to 180° for dimensionally accurate bending, as an accessory. Optimum matching of bending formers and back formers guarantees material-compatible bending without cracks and creases. High strength back formers for low friction support of the thrust pressure. Fast changing of the bending formers and back formers by simple plug system.

### Drive

Oil-hydraulic drive unit with hydraulic cylinder made from high-quality, rolled hydraulic tube. Overload protection of the hydraulic thrust in the foremost piston position and overpressure valves for safe working. Ergonomically designed thrust lever for strength saving pressure build-up with manual hydraulic pump. No danger of crushing due to end limiting of the thrust lever, for high work safety.



German Quality Product



Bridges.



Info



Doglegs on several levels.



### Supply format

**REMS Python Set.** Oil-hydraulic pipe bender for dimensionally accurate bending of pipes up to 90°. Steel pipes EN 10255 Ø ¾ – 2", multilayer composite tubes Ø 32 – 75 mm. Drive unit with back former supports, upper back former support with laterally adjustable back former support bearing plate, 2 back formers, bending formers St or V. In sturdy carrying case.

Description	Art.-No.	€
<b>Set St ¾ + ½ + ¾ + 1 + 1½"</b>	590020R	<b>1.676,37</b>
<b>Set St ½ + ¾ + 1 + 1½ + 1½ + 2"</b>	590021R	<b>1.806,12</b>
<b>Set V 40 + 50 + 63 mm</b>	590022R	<b>1.702,32</b>

### Accessories

Description	Art.-No.	€
<b>Drive unit</b> with back former supports and back formers	590000R	<b>1.479,15</b>
<b>Slide piece Ø 75 mm (pack of 2)</b>	590111R	<b>370,57</b>
<b>Tripod</b>	590150R	<b>168,16</b>
<b>Carrying case</b> with practical handles	590160R	<b>247,04</b>
<b>Angle gauge</b> for dimensionally accurate bending	590153R	<b>43,18</b>

Bending former for pipes Ø mm/inch	Bending radius <sup>1)</sup> mm	Bending radius <sup>2)</sup> mm	suitable for					Art.-No.	€
			St 10255	>					
St ¾"	50		●					590051R	<b>46,81</b>
St ½"	65		●					590052R	<b>55,84</b>
St ¾"	85		●					590053R	<b>67,16</b>
St 1"	100		●					590054R	<b>67,16</b>
St 1¼"	150		●					590055R	<b>75,15</b>
St 1½"	170		●					590056R	<b>91,03</b>
St 2"	220		●					590057R	<b>137,02</b>
V 32 mm	112	128		●				590061R	<b>61,76</b>
V 40 mm	140	160		●				590058R	<b>78,06</b>
V 50 mm	175	200		●				590059R	<b>105,88</b>
V 63 mm	220	252		●				590060R	<b>149,47</b>
V 75 mm	260	298		▲				590062R	<b>330,08</b>

St 10255: Steel pipes (threaded pipes) EN 10255  
 V: multilayer composite pipes of the pressfitting systems  
 ▲ 2 slide pieces Ø 75 mm (Art. No. 590111) required

<sup>1)</sup> Bending radius mm on the inside of the bend (EN 10255)

<sup>2)</sup> Bending radius mm at the neutral axis of the bend (DVGW VP 632)



Universal, compact electric tool for cold bending of pipes and tubes up to 180°. Can be used anywhere, without vice. For trade and industry. For the building site and the workshop.

Hard, half-hard, soft copper tubes also thin-wall	Ø 10 – 35 mm Ø 3/8 – 1 3/8"
--	--------------------------------

Coated soft copper tubes, also thin-wall	Ø 10 – 18 mm
---	--------------

Thick-walled copper pipes K65 for refrigeration and air conditioning technology EN 12735-1	Ø 3/8 – 1 3/8"
--	----------------

Pipes of press fitting systems made of stainless steel	Ø 12 – 28 mm
---	--------------

Carbon steel (coated)	Ø 12 – 28 mm
-----------------------	--------------

Soft precision steel tubes	Ø 10 – 28 mm
----------------------------	--------------

Steel pipes EN 10255	Ø 1/4 – 3/4"
----------------------	--------------

Electric conduit EN 50086	Ø 16 – 32 mm
---------------------------	--------------

Multi-layer composite tubes	Ø 14 – 40 mm
-----------------------------	--------------

**REMS Curvo – wrinkle-free bending.**  
**Universal for many pipe types. Instant use without setting. Fast and creep speed operation for precise bending. Rapid change of bending and back formers.**

### Universal use

For sanitary, heating, air conditioning, refrigerating and hydraulic applications. Specially suited for tubes of pressfitting systems, for hard and half-hard copper tubes and for thin-walled copper heating tubes according to EN 1057.

### System advantage

Only one type of bending and back formers for REMS Curvo 22V, REMS Curvo, REMS Curvo 50 and REMS Sinus. Therefore simple, inexpensive stocking. No confusion possible.

### Cost advantage

Bender cost recovered after a small number of bends. No costs for fittings, storage, procurement. Savings in soldering joints, pressing joints and working hours. Higher safety thanks to fewer pipe joints.

### Design

Compact, handy electric tool with integral absorption of torque during bending. Super light, drive unit only 8 kg. Can be used anywhere, anytime. No setting. Simple, effortless, fast working, e.g. 90° bends, Ø 22 mm in only 6 s. Fast and creep speed operation for precise bending. Overbend, double bend, tier bend, reversed bend possible. Height adjustable machine support as accessory.

### Bending formers and back formers

Form and pressure resistant, in high-strength, high-slide, glass-fibre reinforced polyamide. Optimum matching of bending former and back former guarantees material-compatible gliding without cracks and creases. Angle scale 0 to 180° provided on each bending former and mark on the back former ensure precise bending. Rapid change of bending formers and back formers. Bending formers and back formers for different sizes, materials and bending radii (page 143).

### Drive

Robust, maintenance-free gear. Final point safety in both directions through safety slipping clutch. Proven, powerful universal motor, 1000 W. Right and left-hand rotation. Stepless electronic safety switch for rapid and creep speed operation.

### Bending lubricant

REMS bending spray ensures a permanent lubricating film for reducing energy expenditure and uniform bending. High-pressure-proof, acid-free, CFC-free, so ozone-harmless.



German Quality Product



Info





### Supply format

**REMS Curvo Set.** Electric pipe and tube bender Ø 10–40 mm, Ø ¼–1½", up to 180°. Hard, semi-hard, soft copper pipes, also thin-walled, Ø 10–35 mm, Ø ¾–1½", soft coated copper pipes, also thin-walled, Ø 10–18 mm, thick-walled copper pipes K65 for refrigeration and air conditioning technology EN 12735-1 Ø ¾–1½", pipes of the press fitting systems of stainless steel Ø 12–28 mm, carbon steel, also coated, Ø 12–28 mm, soft precision steel pipes Ø 10–28 mm, steel pipes EN 10255 Ø ¼–¾", electrical installation pipes EN 50086 Ø 16–32 mm, composite tubes Ø 14–40 mm, etc. Drive unit with maintenance-free gear and safety slipping clutch, universal motor 230 V or 110 V, 50–60 Hz, 1000 W, stepless electronic safety switch, right and left-hand rotation, insert bolt. Bending formers and back formers. In sturdy steel case.

Description	Art.-No.	€
<b>Set 15 + 18 + 22</b>	580026R220	<b>1.743,84</b>
<b>Set 15 + 18 + 22 + 28<sup>1)</sup></b>	580027R220	<b>1.941,06</b>
<b>Set 15 + 18 + 22 + 28<sup>2)</sup></b>	580036R220	<b>2.055,24</b>
<b>Set 15 + 18 + 22 + 28<sup>3)</sup></b>	580035R220	<b>2.013,72</b>
<b>Set 12 + 15 + 18 + 22</b>	580020R220	<b>1.837,26</b>
<b>Set 12 + 15 + 18 + 22 + 28<sup>1)</sup></b>	580033R220	<b>2.107,14</b>
<b>Set 12 + 15 + 18 + 22 + 28<sup>2)</sup></b>	580037R220	<b>2.148,66</b>
<b>Set 15 + 22 + 28<sup>1)</sup></b>	580022R220	<b>1.837,26</b>
<b>Set 15 + 22 + 28<sup>2)</sup></b>	580040R220	<b>1.951,44</b>
<b>Set 17 + 20 + 24</b>	580023R220	<b>1.909,92</b>
<b>Set 12 + 14 + 16 + 18 + 22</b>	580021R220	<b>1.930,68</b>
<b>Set 12 + 14 + 16 + 18 + 22 + 28<sup>1)</sup></b>	580031R220	<b>2.138,28</b>
<b>Set 12 + 14 + 16 + 18 + 22 + 28<sup>2)</sup></b>	580038R220	<b>2.242,08</b>
<b>Set 14 + 16 + 18 + 22 + 28<sup>1)</sup></b>	580028R220	<b>2.034,48</b>
<b>Set 14 + 16 + 18 + 22 + 28<sup>2)</sup></b>	580039R220	<b>2.148,66</b>
<b>Set ¾ + ½ + ¾ + ¾ + ¾"</b>	580024R220	<b>2.345,88</b>
<b>Set 16 + 20 + 26 + 32</b>	580025R220	<b>2.231,70</b>
<b>Set 16 + 20 + 25 + 32</b>	580034R220	<b>2.148,66</b>
<b>Set 20 + 25 + 32</b>	580029R220	<b>2.117,52</b>
<b>Set 32 + 40</b>	580030R220	<b>2.148,66</b>
<b>Basic-Pack (without bending and back formers)</b>	580010R220	<b>1.328,64</b>

REMS Curvo Set delivered with the smaller radius bending and back former (except Art.-No. 580029 and 580030), see page 143.

<sup>1)</sup> Bending former and back former 28, R102, Art. No. 581070, for hard, semi-hard copper pipes, also thin-walled. See page 143.

<sup>2)</sup> Bending former and back former 28, ¾" (DN 20), R102, Art. No. 581260, for hard copper pipes Ø 28 mm, Ø 1½", pipes of the press fitting systems of stainless steel/carbon steel Ø 28 mm, steel pipes ¾". See page 143.

<sup>3)</sup> Bending former and back former 28, ¾" (DN 20), R114, Art. No. 581310, for hard, semi-hard copper pipes Ø 28 mm, pipes of the press fitting systems of stainless steel/carbon steel Ø 28 mm, steel pipes ¾". According to DVGW work sheet GW 392 for hard and semi-hard copper pipes Ø 28 mm minimum bending radius 114 mm necessary. Wall thickness ≥ 0.9 mm. See page 143.

### Accessories

Description	Art.-No.	€
<b>Bending formers and back formers</b> see page 143.		
<b>REMS Curvo drive unit</b>	580000R220	<b>1.183,32</b>
<b>Insert bolt</b>	582036	<b>40,79</b>
<b>REMS bending spray</b> , 400 ml	140120R	<b>28,86</b>
<b>Steel case</b> with insert	586000R	<b>128,71</b>
<b>Machine support 3B</b> , height adjustable, on tripod	586100R	<b>243,93</b>
<b>Machine support WB</b> , height adjustable, for mounting on work bench	586150R	<b>171,27</b>



Basic-Pack



3B



WB

Universal, compact electric tool for cold bending of pipes and tubes up to 90°. Can be used anywhere, without vice. For trade and industry. For the building site and the workshop.

Steel pipes EN 10255 (DIN 2440)	Ø ¼ – 1¼"
Stainless steel pipes EN ISO 1127, EN 10217-1	Ø ½ – 1¼" s ≤ 2.6 mm
Hard, half-hard, soft copper tubes	Ø 10 – 42 mm
Thin-wall copper tubes	Ø 10 – 35 mm
Thick-walled copper pipes K65 for refrigeration and air conditioning technology EN 12735-1	Ø ¾ – 1⅝"
Pipes of press fitting systems made of stainless steel	Ø 12 – 42 mm
Carbon steel, also coated	Ø 12 – 42 (28) mm
Multi-layer composite tubes	Ø 14 – 50 mm
Further materials, see REMS Curvo	



## REMS Curvo 50 – wrinkle free bending of large pipes.

### Universal use

For metalwork and in sanitary, heating, air conditioning, refrigeration and hydraulic applications. Specially suited for steel pipe EN 10255, pipe for press-fitting systems, for hard and half hard copper pipe and for thin-walled copper heating pipe according to EN 1057.

### System advantage

Bending formers and back formers of REMS Curvo 22V, REMS Curvo and REMS Sinus (page 143) also fit in the REMS Curvo 50 drive machine with adaptor block 10–40, support 10–40. Therefore simple, inexpensive stocking. No confusion possible.

### Cost advantage

Bender cost recovered after a small number of bends. No costs for fittings, storage, procurement. Savings in soldering joints, pressing joints and working hours. Higher safety thanks to fewer pipe joints.

### Design

Compact, handy electric tool with integral absorption of torque during bending. Can be used anywhere, anytime. No setting. Simple, effortless, fast working, e.g. 90° bends of steel pipe Ø 1¼" in only 37 s. Fast and creep speed operation for precise bending. Overbend, tier bend, reversed bend possible.

### Bending formers and back formers

Optimum matching of bending former and back former guarantees material-compatible gliding without cracks and creases. Angle scale provided on each bending former and mark on the back former ensure precise bending. Rapid change of bending formers and back formers. Bending formers and back formers for different sizes, materials and bending radii (page 143). Bending formers and back formers REMS Curvo 50 (Ø 35 R 100, Ø 42 R 140, Ø 50 R 135, Ø 1" R 100, Ø 1¼" R 140): Form and pressure resistant bending formers in ductile iron and back formers in high-strength, high-slide glass-fibre reinforced polyamide.

### Drive

Robust, maintenance-free gear. Final point safety in both directions through safety slipping clutch. Proven, powerful universal motor, 1000 W. Right and left-hand rotation. Stepless electronic safety switch for rapid and creep speed operation.

### Bending lubricant

REMS bending spray ensures a permanent lubricating film for reducing energy expenditure and uniform bending. High-pressure-proof, acid-free. CFC-free, so ozone-harmless.



German Quality Product



## Supply format

**REMS Curvo 50 Basic-Pack.** Electric pipe and tube bender Ø 10–50 mm, up to 90°. Steel pipes EN 10255 Ø ¼–1¼", stainless steel pipes EN ISO 1127, EN 10217-7, Ø ½–1¼", s ≤ 2.6 mm, hard, semi-hard, soft copper pipes, Ø 10–42 mm, thin-walled copper pipes Ø 10–35 mm, thick-walled copper pipes K65 for refrigeration and air conditioning technology EN 12735-1 Ø ¾–1½", pipes of the press fitting systems of stainless steel Ø 12–42 mm, carbon steel Ø 12–42 mm, coated carbon steel Ø 12–28 mm, composite tubes Ø 14–50 mm, etc. Drive unit with maintenance-free gear and safety slipping clutch, universal motor 230 V or 110 V, 50–60 Hz, 1000 W, stepless electronic safety switch, right and left-hand rotation. Adaptor block 35–50, Support 35–50, insert bolt. In sturdy carrying case.

	Art.-No.	€
	580110R220	<b>3.477,30</b>

Other voltages on request.



## Accessories

Description	Art.-No.	€
<b>Bending formers and back formers</b> see page 143.		
<b>REMS Curvo 50 drive unit</b>	580100R220	<b>3.072,48</b>
<b>Adaptor block 35–50, Support 35–50</b> , for bending formers and back formers Ø 35 R 100, Ø 42 R 140, Ø 50 R 135, Ø 1" R 100, Ø 1¼" R 140 (see page 143).	582110R	<b>184,76</b>
<b>Adaptor block 10–40, Support 10–40</b> , for bending formers and back formers REMS Curvo, REMS Curvo 22V, REMS Sinus (see page 143).	582120R	<b>303,10</b>
<b>Insert bolt</b>	582036	<b>40,79</b>
<b>REMS bending spray</b> , 400 ml	140120R	<b>28,86</b>
<b>Carrying case</b> with practical handles	590160R	<b>247,04</b>
<b>Steel case</b> with insert for each bending former and back former R 100 and R 135/R 140, 90°	586012R	<b>110,03</b>



# REMS Curvo 22V

Cordless tube bender

Universal, mobile electric tool for cold bending of pipes up to 180°. Can be used anywhere, without vice. For trade and industry. For the building site and the workshop. Li-Ion 22V Technology. For battery and corded operation.

Hard, half-hard, soft copper tubes also thin-wall	Ø 10–28 mm Ø 3/8–1 1/8"
---	----------------------------

Coated soft copper tubes, also thin-wall	Ø 10–18 mm
--	------------

Thick-walled copper pipes K65 for refrigeration and air conditioning technology EN 12735-1	Ø 3/8–1 1/8"
--	--------------

Pipes of press fitting systems made of stainless steel	Ø 12–28 mm
--	------------

Carbon steel, also coated	Ø 12–28 mm
---------------------------	------------

Soft precision steel tubes	Ø 10–28 mm
----------------------------	------------

Steel pipes EN 10255	Ø 1/4–3/4"
----------------------	------------

Electric conduit EN 50086	Ø 16–25 mm
---------------------------	------------

Multi-layer composite tubes	Ø 14–40 mm
-----------------------------	------------

## REMS Curvo 22V – wrinkle-free bending of pipes.

**Mobile, handy, light. Universal for many pipe types.**

**Ready to use immediately without setting. Fast and**

**creep speed with immediate stop for precise bending.**

**Quick change of bending and back formers.**

**Li-Ion 21.6V, 5.0Ah battery, for approx. 90 pipe bends of the stainless steel Ø 22 mm press fitting systems with one battery charge\*.**

### Universal use

For sanitary, heating, air conditioning, refrigerating and hydraulic applications. Mains independent. Specially suited for tubes of pressfitting systems, for hard and half-hard copper tubes and for thin-walled copper heating tubes according to EN 1057.

### System advantage

Only one type of bending and back formers for REMS Curvo 22V, REMS Curvo, REMS Curvo 50 and REMS Sinus. Therefore simple, inexpensive stocking. No confusion possible.

### Cost advantage

Bender cost recovered after a small number of bends. No costs for fittings, storage, procurement. Savings in soldering joints, pressing joints and working hours. Higher safety thanks to fewer pipe joints.

### Design

Compact, mobile, handy electric tool with integral absorption of torque during bending. Super light, drive machine with battery pack weights only 8.5 kg. Electronic charging status check with low discharge protection. Practical D-shaped handle with soft grip. Can be used anywhere, anytime. No setting. Simple, effortless, fast working, e.g. 90° bend Ø 22 mm only 6 s. Fast and creep speed with immediate stop for precise bending. Overbend, double bend, tier bend, reversed bend possible. Height adjustable machine support as accessory.

### Bending formers and back formers

Form and pressure resistant, in high-strength, high-slide, glass-fibre reinforced polyamide. Optimum matching of bending former and back former guarantees material-compatible gliding without cracks and creases. Angle scale 0 to 180° provided on each bending former and mark on the back former ensure precise bending. Rapid change of bending formers and back formers. Bending formers and back formers for different sizes, materials and bending radii (page 143).

### Drive

Robust, maintenance-free gear. Final point safety in both directions through safety slipping clutch. Powerful battery motor 21.6 V, with large power reserve, 500 W output. Right and left-hand rotation. Stepless electronic safety switch for fast and creep speed, with immediate stop. Machine status check with overload protection of the drive unit against too high currents, with overheating protection by motor temperature monitoring (NTC), with electronic battery charging status check with charging level indication by a 2-coloured green/red LED.

### Battery or mains operation

Li-Ion 22V Technology. Highly resistant Li-Ion 21.6V battery with 4.4, 5.0 or 9.0 Ah capacity, for long service life. Light and powerful. Li-Ion 21.6V, 4.4 Ah battery, for approx. 79 pipe bends, 5.0Ah battery, for approx. 90 pipe bends, 9.0 Ah for approx. 160 pipe bends of the stainless steel Ø 22 mm press fitting systems with one battery charge\*. Graduated charging status check by coloured LEDs. Operating temperature range – 10 to + 60 °C. No memory effect for maximum battery power. Rapid charger 100–240V, 90W. Rapid charger 100–240V, 290W, for shorter charging times, as accessory. Voltage supply 220–240V/21.6V, 40A output, for mains operation instead of Li-Ion battery 21.6 V, as accessory.



German Quality Product



Info

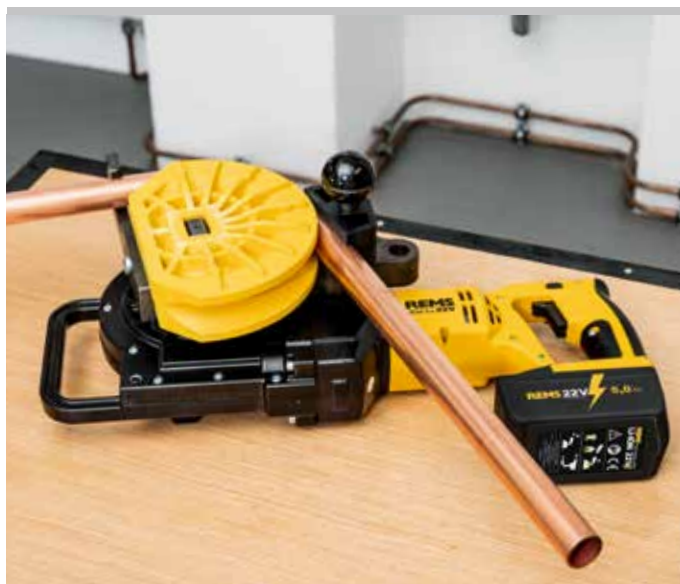

## Bending lubricant

REMS bending spray ensures a permanent lubricating film for reducing energy expenditure and uniform bending. High-pressure-proof, acid-free, CFC-free, so ozone-harmless.

## Supply format

**REMS Curvo 22V Set.** Cordless tube bender Ø 10–40 mm, Ø ¼–1 ½", to 180°. Hard, semi-hard, soft copper pipes, also thin-walled, Ø 10–28 mm, Ø ¾–1 ½", soft coated copper pipes, also thin-walled, Ø 10–18 mm, thick-walled copper pipes K65 for refrigeration and air conditioning technology EN 12735-1 Ø ¾–1 ½", pipes of the press fitting systems of stainless steel Ø 12–28 mm, carbon steel, also coated, Ø 12–28 mm, soft precision steel pipes Ø 10–28 mm, steel pipes EN 10255 Ø ¼–¾", electrical installation pipes EN 50086 Ø 16–25 mm, composite tubes Ø 14–40 mm, etc. Drive machine with D-shaped handle, maintenance-free gear with safely slipping clutch, powerful battery motor 21.6 V, stepless, electronic safety switch with immediate stop, right and left-hand rotation. Machine status check with overload protection, temperature monitoring, battery charging status check. Li-Ion 21.6 V, 5.0 Ah battery, 100–240 V, 50–60 Hz, 90 W rapid charger. Insert bolt. Bending and back formers. In sturdy steel case.

Description	Art.-No.	€
<b>Set 15 + 18 + 22</b>	580051 R220	<b>2.539,99</b>
<b>Set 15 + 18 + 22 + 28<sup>1)</sup></b>	580052 R220	<b>2.818,17</b>
<b>Set 15 + 18 + 22 + 28<sup>2)</sup></b>	580053 R220	<b>2.792,22</b>
<b>Set 15 + 18 + 22 + 28<sup>3)</sup></b>	580054 R220	<b>2.750,70</b>
<b>Set 12 + 15 + 18 + 22</b>	580055 R220	<b>2.574,24</b>
<b>Set 12 + 15 + 18 + 22 + 28<sup>1)</sup></b>	580056 R220	<b>2.844,12</b>
<b>Set 12 + 15 + 18 + 22 + 28<sup>2)</sup></b>	580057 R220	<b>2.885,64</b>
<b>Set 15 + 22 + 28<sup>1)</sup></b>	580058 R220	<b>2.574,24</b>
<b>Set 15 + 22 + 28<sup>2)</sup></b>	580059 R220	<b>2.688,42</b>
<b>Set 17 + 20 + 24</b>	580060 R220	<b>2.646,90</b>
<b>Set 12 + 14 + 16 + 18 + 22</b>	580061 R220	<b>2.667,66</b>
<b>Set 12 + 14 + 16 + 18 + 22 + 28<sup>1)</sup></b>	580062 R220	<b>2.875,26</b>
<b>Set 12 + 14 + 16 + 18 + 22 + 28<sup>2)</sup></b>	580063 R220	<b>2.979,06</b>
<b>Set 14 + 16 + 18 + 22 + 28<sup>1)</sup></b>	580064 R220	<b>2.771,46</b>
<b>Set 14 + 16 + 18 + 22 + 28<sup>2)</sup></b>	580065 R220	<b>2.885,64</b>
<b>Set ¾ + ½ + ¾ + ¾ + ¾ + ¾"</b>	580066 R220	<b>3.082,86</b>
<b>Set 16 + 20 + 26 + 32</b>	580067 R220	<b>2.968,68</b>
<b>Set 16 + 20 + 25 + 32</b>	580068 R220	<b>2.885,64</b>
<b>Set 20 + 25 + 32</b>	580069 R220	<b>2.854,50</b>
<b>Basic-Pack (without bending and back formers)</b>	580014 R220	<b>2.065,62</b>

Other voltages on request.

REMS Curvo 22V Set delivered with the smaller radius bending and back former (except Art.-No. 580069), see page 143.

<sup>1)</sup> Bending former and back former 28, R102, Art. No. 581070, for hard, semi-hard copper pipes, also thin-walled. See page 143.

<sup>2)</sup> Bending former and back former 28, ¾" (DN 20), R102, Art. No. 581260, for hard copper pipes Ø 28 mm, Ø 1 ½", pipes of the press fitting systems of stainless steel/carbon steel Ø 28 mm. See page 143.

<sup>3)</sup> Bending former and back former 28, ¾" (DN 20), R114, Art. No. 581310, for hard, semi-hard copper pipes Ø 28 mm, pipes of the press fitting systems of stainless steel/carbon steel Ø 28 mm, steel pipes ¾". According to DVGW work sheet GW 392 for hard and semi-hard copper pipes Ø 28 mm minimum bending radius 114 mm necessary. Wall thickness ≥ 0.9 mm. See page 143.

## Accessories

Description	Art.-No.	€
<b>Bending formers and back formers see page 143.</b>		
<b>REMS Curvo 22V drive unit, without battery</b>	580004 R22	<b>1.442,82</b>
<b>Battery Li-Ion 21.6 V, 4.4 Ah</b>	571574 R22	<b>372,64</b>
<b>Battery Li-Ion 21.6 V, 5.0 Ah</b>	571581 R22	<b>310,36</b>
<b>Battery Li-Ion 21.6 V, 9.0 Ah</b>	571583 R22	<b>414,16</b>
<b>Rapid charger 100–240 V, 50–60 Hz, 90 W</b>	571585 R220	<b>175,42</b>
<b>Rapid charger 100–240 V, 50–60 Hz, 290 W</b>	571587 R220	<b>414,16</b>
<b>Voltage supply 220–240 V/21.6 V, 50–60 Hz, 40 A, for mains operation instead of battery Li-Ion 21.6 V</b>	571578 R220	<b>517,96</b>
<b>Insert bolt</b>	582036	<b>40,79</b>
<b>REMS bending spray, 400 ml</b>	140120R	<b>28,86</b>
<b>Steel case with inlay</b>	566030R	<b>128,71</b>
<b>Machine support 3B, height adjustable, on tripod</b>	586100R	<b>243,93</b>
<b>Machine support WB, height adjustable, for mounting on work bench</b>	586150R	<b>171,27</b>
<b>REMS Lumen 2800 22V, cordless LED flood light, see page 111</b>		



Basic-Pack



3B

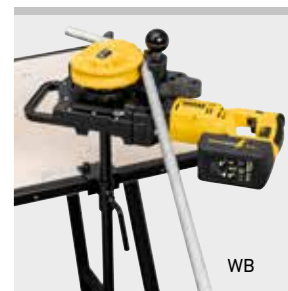

WB

Universal, robust hand tool for cold bending up to 180°. Can be used anywhere. For trade and industry. For the building site and the workshop.

Hard, half-hard, soft copper tubes, also thin-wall	Ø 10 – 22 mm Ø 3/8 – 7/8"
Coated soft copper tubes, also thin-wall	Ø 10 – 18 mm
Pipes of press fitting systems made of stainless steel, carbon steel (coated)	Ø 12 – 18 mm
Carbon steel	Ø 12 – 22 mm
Soft precision steel tubes	Ø 10 – 20 mm
Electric conduit EN 50086	Ø 16 – 20 mm
Multi-layer composite tubes	Ø 14 – 32 mm

**REMS Sinus – wrinkle-free bending.**  
**Universal for many tubes. Easy bending through long lever arms. Selectable lever positioning ensures optimum bending position and power transmission. Only one type of bending and back formers for REMS Sinus and REMS Curvo.**

### Universal use

For sanitary, heating, air conditioning, refrigerating and hydraulic applications. Specially suited for tubes of pressfitting systems, for hard and half-hard copper tubes and for thin-walled copper heating tubes according to EN 1057.

### System advantage

Only one type of bending and back formers for REMS Curvo 22V, REMS Curvo, REMS Curvo 50 and REMS Sinus. Therefore simple, inexpensive stocking. No confusion possible.

### Cost advantage

Bender cost recovered after a small number of bends. No costs for fittings, storage, procurement. Savings in soldering joints, pressing joints and working hours. Higher safety thanks to fewer pipe joints.

### Design

Compact, handy unit of bender drive and bending tools. Can be used anywhere, in parallel vice or free hand as double-hand-bender. Easy bending through long lever arms. Selectable lever positioning ensures optimum bending position and power transmission. Robust design, drive unit in hardened steel for high stress. Simple and rapid changing of bending and back formers. Crossover, swan-neck and U-bends possible.

### Bending formers and back formers

For different pipe sizes, materials and bending radii, see page 143.

### Bending lubricant

REMS bending spray ensures a permanent lubricating film for reducing energy expenditure and for uniform bending. High-pressure-proof, acid-free. CFC-free, so ozone-harmless.

### Supply format

**REMS Sinus Set.** Hand tube bender Ø 10–32 mm, Ø 3/8–7/8", up to 180°. Hard, half-hard, soft copper tubes, also thin-wall Ø 10–22 mm, Ø 3/8–7/8", coated soft copper tubes, also thin-wall Ø 10–18 mm, pipes of the press fitting systems made of stainless steel, carbon steel (coated) Ø 12–18 mm, soft precision steel tubes Ø 10–22 mm, soft precision steel tubes, Ø 10–20 mm, electric conduit EN 50086, Ø 16–20 mm, multi-layer composite tubes Ø 14–32 mm and others. Drive unit, insert bolt. Bending formers and back formers. REMS bending spray. In sturdy steel case.

Description	Art.-No.	€
<b>Set 15 + 18 + 22</b>	154001R	<b>803,41</b>
<b>Set 14 + 16 + 18</b>	154002R	<b>774,35</b>
<b>Set 12 + 15 + 18 + 22</b>	154003R	<b>903,06</b>
<b>Set 10 + 12 + 14 + 16 + 18 + 22</b>	154004R	<b>1.137,65</b>
<b>Basic-Pack</b> (without bending and back formers and bending spray)	154010R	<b>468,14</b>

REMS Sinus Set is delivered with bending formers and back formers of the smaller radius, see page 143.

### Accessories

Description	Art.-No.	€
<b>Bending and back formers</b> see page 143.		
<b>Insert bolt</b>	582036	<b>40,79</b>
<b>REMS Curvo drive unit</b>	580000R220	<b>1.183,32</b>
<b>REMS Sinus drive unit</b>	154000R	<b>299,98</b>
<b>REMS bending spray, 400 ml</b>	140120R	<b>28,86</b>
<b>Steel case with inlay</b>	154160R	<b>128,71</b>

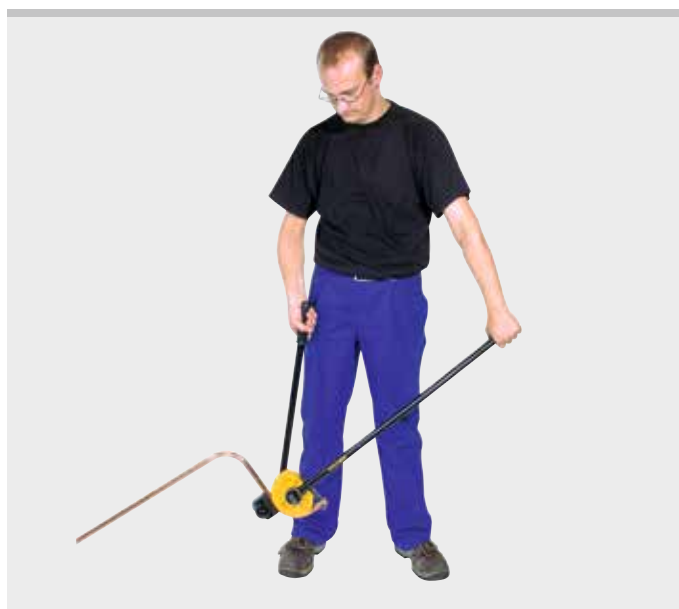
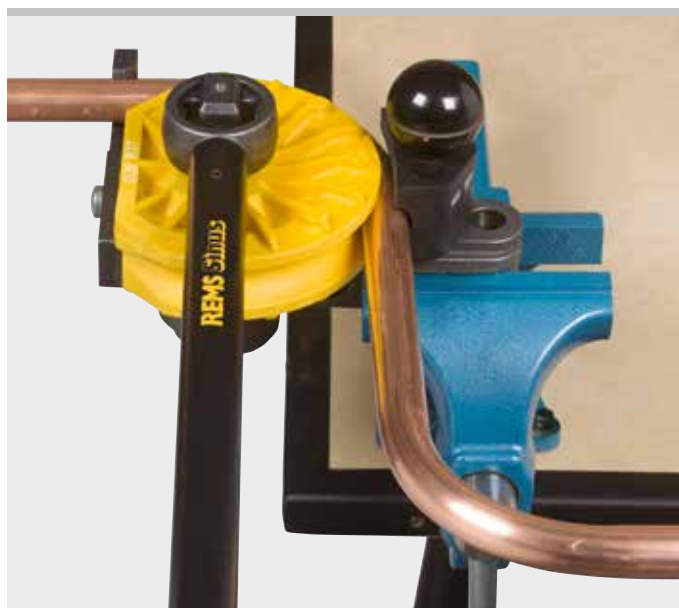

German Quality Product



Info























# Radial Press Jointing

	<b>Cordless radial press Mini</b>	<b>147</b>
	<b>Pressing tongs Mini</b>	<b>152</b>
	<b>Cropping tongs Mini</b>	<b>184</b>
	<b>Manual radial press</b>	<b>185</b>
	<b>Electric radial press</b>	<b>186</b>
	<b>Electro-hydraulic radial presses</b>	<b>187</b>
	<b>Cordless radial presses</b>	<b>190</b>
	<b>Pressing tongs / pressing rings</b>	<b>198</b>
   	<b>Hold-Harmless and Indemnification Agreement</b>	<b>240</b>
	<b>Cropping tongs</b>	<b>241</b>
	<b>Cable shears</b>	<b>241</b>

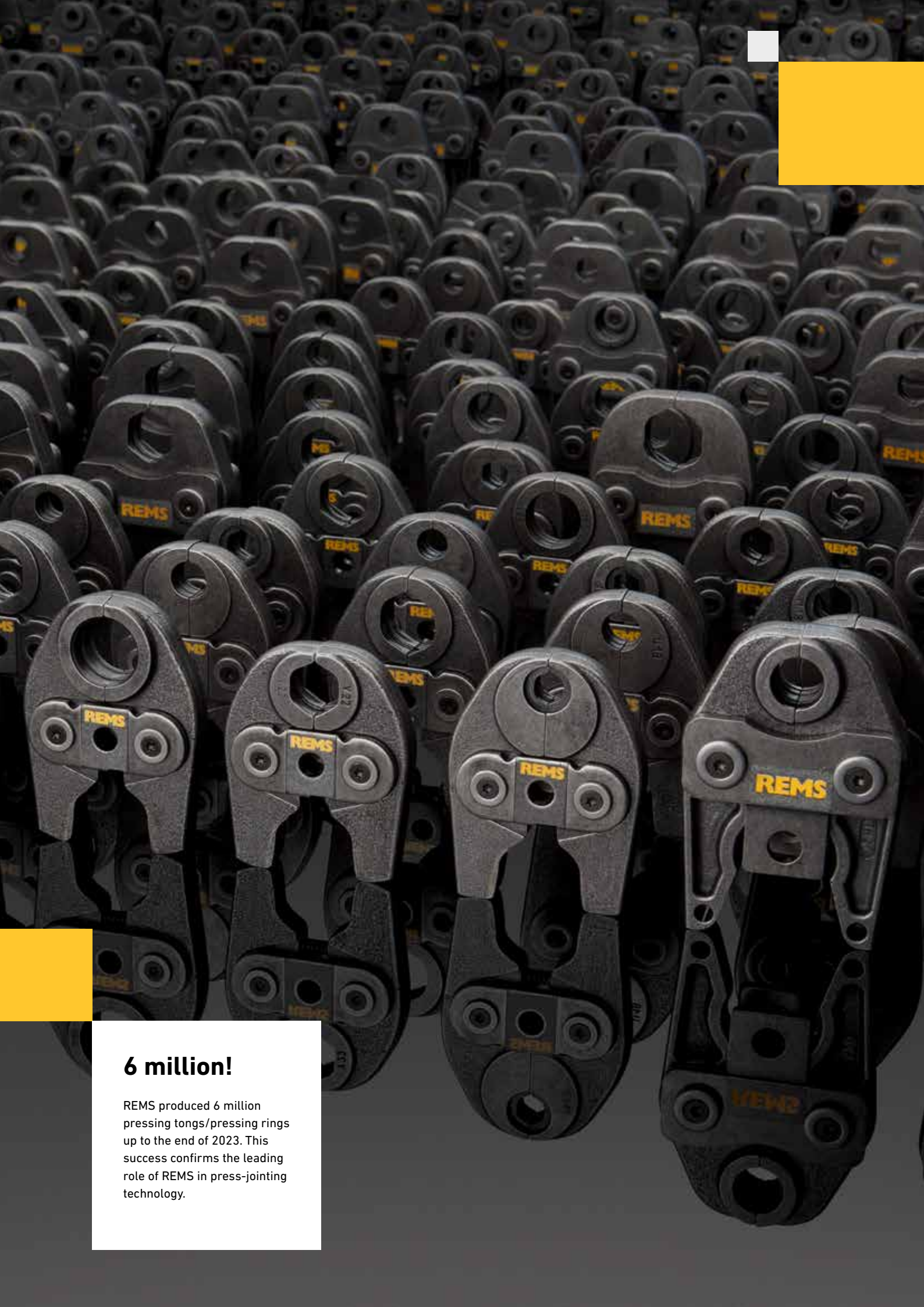

## 6 million!

REMS produced 6 million pressing tongs/pulling rings up to the end of 2023. This success confirms the leading role of REMS in press-jointing technology.

# REMS Mini-Press 14 V ACC

Cordless radial press 22 kN with automatic circuit control

Universal, super handy electric tool with automatic circuit control for producing pipe pressing joints for all common pressfitting systems. For battery and corded operation.

Pipe pressing joints  $\varnothing$  10–40 mm  $7 \varnothing \frac{3}{8} - 1 \frac{1}{4}$

Complete range of REMS pressing tongs Mini/pressing rings for all common pressfitting systems, see page 152–183.

**REMS Mini-Press 14 V ACC – universal up to  $\varnothing$  40 mm. Super light, super small, super handy. Secure crimping in seconds. With automatic circuit control. Automatic locking of the pressing tongs.**

### Pressing tongs for all common systems

Complete assortment of REMS pressing tongs Mini/pressing rings for all common pressfitting systems (page 152–183). Can be driven by all REMS radial presses 22 kN. Highly durable pressing tongs/pressing rings made of forged, tenacious, specially hardened special steel. Pressing contours of REMS pressing tongs/pressing rings are system-specific and correspond to the respective pressfitting system. Thus perfect system-conformity, safe press jointing. Adapter tongs required for driving the REMS S (PR-2B) pressing rings, see page 183. All pressing rings S (PR-2B) marked with \*\* can also be driven with the manual radial press REMS Eco-Press using the adapter tong Z8.

Very compact design and low weight of the REMS Mini pressing tongs due to special arrangement of the pressing tongs connection (**Patent EP 1 952 948**). Recesses in the pressing jaws for safe guidance of the connecting plate for offset-free pressing (**Patent EP 2 347 862**).

### Design

Super light, super small, super handy. Drive unit with battery only 2.4 kg. Drive unit with pressing tongs V22 only 33 cm long. Works anywhere, free-hand, overhead, also in particularly tight areas. Optimum weight distribution for single-hand operation. Ergonomically designed housing. LED work light for illuminating the work place. Swivelling pressing tongs seat. Secure seating of pressing tongs/adapter tongs by automatic locking. Electronic charging status check with flat battery protection and charging status indicator with 2-coloured LED.

### Pressing operation by touch-control with ACC

For reliable service, operating and functional safety. Automatic retraction after completion of pressing operation (automatic circuit control).

### Drive

Enormous thrust and pressing force for fast and perfect press jointing. Thrust force 22 kN. Powerful electro-hydraulic drive with powerful battery motor 14.4 V, 380 W output, robust planetary gear, eccentric reciprocating pump and compact high power hydraulic system. Safety tip switch.

### Battery or mains operation

Li-Ion PLUS technology. Highly resistant Li-Ion 14.4 V battery with 2.5 or 5.0 Ah capacity for long service life. Light and powerful. Li-Ion 14.4 V, 2.5 Ah batteries for approx. 275 pressings, 5.0 Ah for approx. 550 pressings Viega Profipress DN 15 with one battery charge\*. Operating temperature range  $-10$  to  $+60$  °C. No memory effect for maximum battery power. Rapid charger 220–240 V, 10.8–18 V, 65 W, for short charging times. Voltage supply 220–240 V/14.4 V, 33 A output, for mains operation instead of Li-Ion battery 14.4 V, as accessory.

### Supply format

**REMS Mini-Press 14 V ACC Basic-Pack.** Cordless radial press 22 kN with automatic circuit control for producing pipe pressing joints  $\varnothing$  10–40 mm,  $\varnothing \frac{3}{8} - 1 \frac{1}{4}$ ". For operating with REMS pressing tongs Mini/pressing rings. Swivelling pressing tongs seat with automatic locking. Electro-hydraulic drive with powerful battery motor 14.4 V, 380 W, robust planetary gear, eccentric reciprocating pump and compact high power hydraulic system. Safety tip switch. LED work light. Battery Li-Ion 14.4 V, 2.5 Ah, rapid charger 220–240 V, 50–60 Hz, 10.8–18 V, 65 W.

Version	Art.-No.	€
In sturdy steel case.	578012R220	<b>1.505,10</b>
In L-Boxx system case.	578013R220	<b>1.546,62</b>

Other voltages on request.

### Accessories

Description	Art.-No.	€
<b>REMS pressing tongs Mini/pressing rings</b> see page 152–183.		
<b>Adapter tongs Mini Z8</b> for driving REMS pressing rings S (PR-2B)	574700R	<b>144,28</b>
<b>REMS cropping tongs Mini</b> for threaded rods see page 184.		
<b>REMS Mini-Press 14 V ACC drive unit,</b> without battery	578001R14	<b>1.079,52</b>
<b>Battery Li-Ion 14.4 V, 2.5 Ah</b>	571545R14	<b>160,89</b>
<b>Battery Li-Ion 14.4 V, 5.0 Ah</b>	571555R14	<b>227,32</b>
<b>Rapid charger 220–240 V, 50–60 Hz, 10.8–18 V, 65 W</b>	571560R220	<b>154,66</b>
<b>Voltage supply 220–240 V/14.4 V, 50–60 Hz, 33 A,</b> for mains operation instead of battery Li-Ion 14.4 V.	571565R220	<b>351,88</b>
<b>Steel case with inlay</b>	578290R	<b>110,03</b>
<b>L-Boxx system case with inserts</b>	578299R	<b>146,36</b>

All prices excl. VAT



German Quality Product



\* Ambient temperature approx. 20°C.

# REMS Mini-Press 22 V ACC

Cordless radial press 22 kN with automatic circuit control

Universal, super handy electric tool with automatic circuit control for all common pressfitting systems. Li-Ion 22V Technology. For battery and corded operation.

Pipe pressing joints	Ø 10 – 40 mm
	Ø 3/8 – 1 1/4"

Complete range of REMS pressing tongs Mini/pressing rings for all common pressfitting systems, see page 152–183.

**REMS Mini-Press 22 V ACC – universal up to Ø 40 mm. Super light, super small, super handy, ultra fast. Pressing under 4 s. With automatic circuit control, Automatic locking of pressing tongs. Li-Ion 21.6 V, 2.5 Ah battery for approx. 390 pressings Viega Profipress DN 15 with one battery charge\*.**

## Pressing tongs for all common systems

Complete assortment of REMS pressing tongs Mini/pressing rings for all common pressfitting systems (page 152–183). Can be driven by all REMS radial presses 22 kN. Highly durable pressing tongs/pressing rings made of forged, tenacious, specially hardened special steel. Pressing contours of REMS pressing tongs/pressing rings are system-specific and correspond to the respective pressfitting system. Thus perfect system-conformity, safe press jointing. Adapter tongs required for driving the REMS S (PR-2B) pressing rings, see page 183. All pressing rings S (PR-2B) marked with \*\* can also be driven with the manual radial press REMS Eco-Press using the adapter tong Z8.

Very compact design and low weight of the REMS Mini pressing tongs due to special arrangement of the pressing tongs connection (**Patent EP 1 952 948**). Recesses in the pressing jaws for safe guidance of the connecting plate for offset-free pressing (**Patent EP 2 347 862**).

## Design

Super light, super small, super handy. Drive unit with battery only 2.5 kg. Drive unit with pressing tongs V15 only 31 cm long. Works anywhere, free-hand, overhead, also in particularly tight areas. Optimum weight distribution for single-hand operation. Drive unit with inserted pressing tongs can be put down on the battery ready to pick up. Ergonomically designed housing with soft grip. LED work light for illuminating the work place. Swivelling pressing tongs seat, rotation angle > 360°. Secure seating of pressing tongs/adapter tongs by automatic locking.

## Pressing operation by touch-control with ACC

For reliable service, operating and functional safety. Automatic retraction after completion of pressing operation (automatic circuit control). Ultra fast Pressing under 4 s.

## Drive

Enormous thrust and pressing force for fast and perfect press jointing. Thrust force 22 kN. Powerful electro-hydraulic drive with powerful battery motor 21.6 V, 380 W output, robust planetary gear, eccentric reciprocating pump and compact high power hydraulic system. Safety tip switch.

## Battery or mains operation

Li-Ion 22V Technology. Highly resistant Li-Ion 21.6V battery with 2.5, 4.4, 5.0 or 9.0 Ah capacity, for long service life. Light and powerful. Li-Ion 21.6V, 2.5 Ah batteries for approx. 390 pressings, 4.4 Ah for approx. 685 pressings, 5.0 Ah for approx. 780 pressings, 9.0 Ah for approx. 1400 pressings Viega Profipress DN 15 with one battery charge\*. Graduated charging status check by coloured LEDs. Operating temperature range – 10 to + 60 °C. No memory effect for maximum battery power. Rapid charger 100–240V, 90W. Rapid charger 100–240V, 290W, for shorter charging times, as accessory. Voltage supply 220–240V/21.6 V, 15 A output, for mains operation instead of Li-Ion battery 21.6 V, as accessory.



German Quality Product



Info



## Supply format

**REMS Mini-Press 22 V ACC Basic-Pack.** Cordless radial press 22 kN with automatic circuit control for producing pipe pressing joints  $\varnothing$  10–40 mm,  $\varnothing$   $\frac{3}{8}$  – 1  $\frac{1}{4}$ ". For operating with REMS pressing tongs Mini/pressing rings. Swivelling pressing tongs seat with automatic locking. Electro-hydraulic drive with powerful battery motor 21.6 V, 380 W, robust planetary gear, eccentric reciprocating pump and compact high power hydraulic system. Safety tip switch. LED work light. Battery Li-Ion 21.6 V, 2.5 Ah, rapid charger 220–240 V or 110 V, 50–60 Hz, 70 W.

Version	Art.-No.	€
In sturdy steel case.	578010R220	<b>1.785,36</b>
In L-Boxx system case.	578014R220	<b>1.826,88</b>

Other voltages on request.

## Accessories

Description	Art.-No.	€
<b>REMS pressing tongs Mini/pressing rings</b> see page 152–183.		
<b>Adapter tongs Mini Z8</b> for driving REMS pressing rings S (PR-2B)	574700R	<b>144,28</b>
<b>REMS cropping tongs Mini</b> for threaded rods see page 184.		
<b>REMS Mini-Press 22 V ACC drive unit,</b> without battery	578002R22	<b>1.266,36</b>
<b>Battery Li-Ion 21.6 V, 2.5 Ah</b>	571571R22	<b>258,46</b>
<b>Battery Li-Ion 21.6 V, 4.4 Ah</b>	571574R22	<b>372,64</b>
<b>Battery Li-Ion 21.6 V, 5.0 Ah</b>	571581R22	<b>310,36</b>
<b>Battery Li-Ion 21.6 V, 9.0 Ah</b>	571583R22	<b>414,16</b>
<b>Rapid charger 100–240 V, 50–60 Hz, 90 W</b>	571585R220	<b>175,42</b>
<b>Rapid charger 100–240 V, 50–60 Hz, 290 W</b>	571587R220	<b>414,16</b>
<b>Voltage supply 220–240 V/21.6 V, 50–60 Hz, 15 A,</b> for mains operation instead of battery Li-Ion 21.6 V.	571567R220	<b>414,16</b>
<b>Steel case with inlay</b>	578290R	<b>110,03</b>
<b>L-Boxx system case with inserts</b>	578299R	<b>146,36</b>
<b>REMS Lumen 2800 22 V,</b> cordless LED flood light, see page 111		



# REMS Mini-Press S 22 V ACC

Cordless radial press 22 kN with automatic circuit control

Universal, super handy electric tool with automatic circuit control for all common pressfitting systems. Li-Ion 22V Technology. For battery and corded operation.

Pipe pressing joints  $\varnothing$  10 – 40 mm  
 $\varnothing$   $\frac{3}{8}$  –  $\frac{1}{4}$ "

Complete range of REMS pressing tongs Mini/pressing rings for all common pressfitting systems, see page 152–183.

**REMS Mini-Press S 22 V ACC – universal up to  $\varnothing$  40 mm. Super light, super small, super handy, ultra fast. Pressing under 4 s. With automatic circuit control, Automatic locking of pressing tongs. Li-Ion 21.6 V, 2.5 Ah battery for approx. 390 pressings Viega Profipress DN 15 with one battery charge\*.**

## Pressing tongs for all common systems

Complete assortment of REMS pressing tongs Mini/pressing rings for all common pressfitting systems (page 152–183). Can be driven by all REMS radial presses 22 kN. Highly durable pressing tongs/pressing rings made of forged, tenacious, specially hardened special steel. Pressing contours of REMS pressing tongs/pressing rings are system-specific and correspond to the respective pressfitting system. Thus perfect system-conformity, safe press jointing. Adapter tongs required for driving the REMS S (PR-2B) pressing rings, see page 183. All pressing rings S (PR-2B) marked with \*\* can also be driven with the manual radial press REMS Eco-Press using the adapter tong Z8.

Very compact design and low weight of the REMS Mini pressing tongs due to special arrangement of the pressing tongs connection (**Patent EP 1 952 948**). Recesses in the pressing jaws for safe guidance of the connecting plate for offset-free pressing (**Patent EP 2 347 862**).

## Design

Super light, super small, super handy. Drive unit with battery only 2.6 kg. Works anywhere, free-hand, overhead, also in particularly tight areas. Optimum weight distribution for single-hand operation. Drive unit with inserted pressing tongs can be put down on the battery ready to pick up. Ergonomically designed housing with soft grip. LED work light for illuminating the work place. Swivelling pressing tongs seat, rotation angle  $>360^\circ$ . Secure seating of pressing tongs/adapter tongs by automatic locking.

## Pressing operation by touch-control with ACC

For reliable service, operating and functional safety. Automatic retraction after completion of pressing operation (automatic circuit control). Ultra fast Pressing under 4 s.

## Drive

Enormous thrust and pressing force for fast and perfect press jointing. Thrust force 22 kN. Powerful electro-hydraulic drive with powerful battery motor 21.6 V, 380 W output, robust planetary gear, eccentric reciprocating pump and compact high power hydraulic system. Safety tip switch.

## Battery or mains operation

Li-Ion 22V Technology. Highly resistant Li-Ion 21.6V battery with 2.5, 4.4, 5.0 or 9.0 Ah capacity, for long service life. Light and powerful. Li-Ion 21.6V, 2.5 Ah batteries for approx. 390 pressings, 4.4 Ah for approx. 685 pressings, 5.0 Ah for approx. 780 pressings, 9.0 Ah for approx. 1400 pressings Viega Profipress DN 15 with one battery charge\*. Graduated charging status check by coloured LEDs. Operating temperature range  $-10$  to  $+60^\circ\text{C}$ . No memory effect for maximum battery power. Rapid charger 100–240V, 90W. Rapid charger 100–240V, 290W, for shorter charging times, as accessory. Voltage supply 220–240V/21.6V, 15 A output, for mains operation instead of Li-Ion battery 21.6 V, as accessory.



German Quality Product



Info



## Supply format

**REMS Mini-Press S 22V ACC Basic-Pack.** Cordless radial press 22 kN with automatic circuit control for producing pipe pressing joints  $\varnothing$  10–40 mm,  $\varnothing$   $\frac{3}{8}$  –  $1\frac{1}{4}$ ". For operating with REMS pressing tongs Mini/pressing rings. Swivelling pressing tongs seat with automatic locking. Electro-hydraulic drive with powerful battery motor 21.6 V, 380 W, robust planetary gear, eccentric reciprocating pump and compact high power hydraulic system. Safety tip switch. LED work light. Battery Li-Ion 21.6 V, 2.5 Ah, rapid charger 220–240 V or 110 V, 50–60 Hz, 70 W.

Version	Art.-No.	€
In sturdy steel case.	578015R220	<b>1.785,36</b>
In L-Boxx system case.	578016R220	<b>1.826,88</b>

Other voltages on request.

## Accessories

Description	Art.-No.	€
<b>REMS pressing tongs Mini/pressing rings</b> see page 152 – 183.		
<b>Adapter tongs Mini Z8</b> for driving REMS pressing rings S (PR-2B)	574700R	<b>144,28</b>
<b>REMS cropping tongs Mini</b> for threaded rods see page 184.		
<b>REMS Mini-Press S 22V ACC drive unit,</b> without battery	578003R22	<b>1.266,36</b>
<b>Battery Li-Ion 21.6 V, 2.5 Ah</b>	571571R22	<b>258,46</b>
<b>Battery Li-Ion 21.6 V, 4.4 Ah</b>	571574R22	<b>372,64</b>
<b>Battery Li-Ion 21.6 V, 5.0 Ah</b>	571581R22	<b>310,36</b>
<b>Battery Li-Ion 21.6 V, 9.0 Ah</b>	571583R22	<b>414,16</b>
<b>Rapid charger 100–240 V, 50–60 Hz, 90 W</b>	571585R220	<b>175,42</b>
<b>Rapid charger 100–240 V, 50–60 Hz, 290 W</b>	571587R220	<b>414,16</b>
<b>Voltage supply 220–240 V/21.6 V, 50–60 Hz, 15 A,</b> for mains operation instead of battery Li-Ion 21.6 V.	571567R220	<b>414,16</b>
<b>Steel case with inlay</b>	578290R	<b>110,03</b>
<b>L-Boxx system case with inserts</b>	578299R	<b>146,36</b>
<b>REMS Lumen 2800 22 V,</b> cordless LED flood light, see page 111		



for all common pressfitting systems

**Select REMS pressing tongs Mini/  
REMS pressing rings yourself!**

Find the desired press fitting system in the table below and choose the size of pressing tongs/pressing rings that you require. Please note that pressfitting systems for gas installation may only be pressed with the REMS pressing tongs Mini/pressing rings which are highlighted in yellow in the table.

Highly durable pressing tongs/pressing rings made of tenacious, specially hardened special steel. Pressing contours of REMS pressing tongs/pressing rings are system-specific and correspond with the respective pressfitting system. Thus perfect system-conformity, safe press jointing. Pressing jaws of pressing tongs/pressing rings manufactured on CNC production centres ensure high-precision machining of pressing contour. Low production tolerances as a result.

Can be driven by all REMS radial presses 22 kN. Adapter tongs (page 183) required for driving REMS pressing rings. All pressing rings S (PR-2B) marked with \*\* can also be driven with the manual radial press REMS Eco-Press (page 185) using the adapter tong Z8.

Read and observe the instructions for use and the installation instructions of the system provider/manufacturer.

**REMS pressing tongs Mini (PZ-2B)**

REMS Mini pressing tongs (PZ-2B) with 2 swivellable monoblock pressing jaws. Very compact design and low weight of the REMS Mini pressing tongs due to special arrangement of the pressing tongs connection (**Patent EP 1 952 948**). Recesses in the pressing jaws for safe guidance of the connecting plate for offset-free pressing (**Patent EP 2 347 862**).

REMS Mini ACz, Fz, HEz, RFz, RFlz pressing tongs with teeth prevent formation of burr on the pressfitting (**Patent EP 2 027 971**).

**REMS pressing ring S (PR-2B)**

REMS pressing ring S (PR-2B), continuously swivellable, with 2 pressing jaws, for secure engagement of the pressing jaws in places of difficult access. Adapter tongs required for driving the REMS S (PR-2B) pressing rings, see page 183.

**Traceability according to EN 1775:2007**

REMS pressing tongs Mini with pressing contour F, M, V, SA, B, RN and UP have worked a specific marking into the pressing contour which leaves a lasting impression on the pressed fitting after the pressing process. This enables the user to check again whether the most suitable pressing tongs have been used to make the pressfit connection even after the pressing process.

With this traceability REMS fulfils the recommendations of the European standard EN 1775:2007 for the installation of pressfitting systems for gas.



German Quality Product



REMS Mini pressing tongs (PZ-2B)



REMS pressing ring S (PR-2B), continuously swivellable

**Confirmation of suitability**

See page 239.

**Hold-Harmless and Indemnification Agreement**

See page 240.





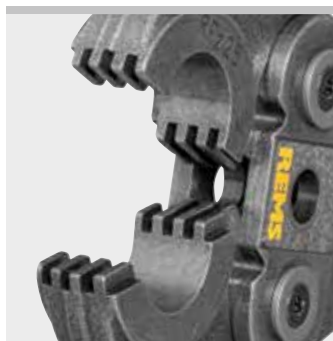

Pressing tongs with teeth prevent formation of burr on the pressfitting. Patent EP 2 027 971

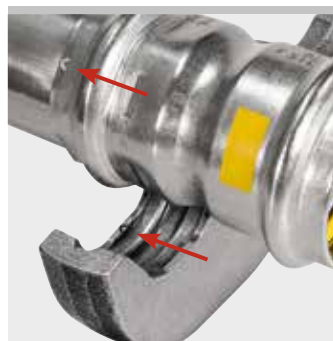

Example REMS pressing tongs Mini V: "V" imprint on pressed fitting for traceability according to EN 1775:2007



System	Pressing tongs Mini / pressing rings	Driven by adapter tongs	Art.-No.	€	System	Pressing tongs Mini / pressing rings	Driven by adapter tongs	Art.-No.	€
AHLSSELL	M 12		578310	146,98	ALB	TH 16		578352 R	177,08
A-press	M 15		578312	146,98	Sistema Multicapa	TH 18		578356	177,08
elföorzinkad M	M 18		578314	146,98	para calefacción y sanitario	TH 20		578358 R	177,08
	M 22		578316	146,98		TH 26		578362 R	177,08
	M 28		578318	146,98		TH 32		578364	177,08
	M 35		578390	178,12		TH 40		578624	234,69
	M 12 S (PR-2B)	Mini Z8	574736 R	124,51		TH 16 S (PR-2B)**	Mini Z8	574782 R	124,51
	M 15 S (PR-2B)	Mini Z8	574738 R	124,51		TH 18 S (PR-2B)**	Mini Z8	574786 R	124,51
	M 18 S (PR-2B)	Mini Z8	574740 R	124,51		TH 20 S (PR-2B)**	Mini Z8	574788 R	124,51
	M 22 S (PR-2B)	Mini Z8	574742 R	124,51		TH 26 S (PR-2B)**	Mini Z8	574794 R	124,51
	M 28 S (PR-2B)	Mini Z8	574744 R	124,51		TH 32 S (PR-2B)	Mini Z8	574798 R	136,96
	M 35 S (PR-2B)	Mini Z8	574746 R	136,96		H 16		578400	159,75
AHLSSELL	V 12		578324	146,98		H 18		578404	159,75
A-press	V 15		578328	146,98		H 20		578406	159,75
elföorzinkad V	V 18		578332	146,98		H 26		578410	159,75
	V 22		578334	146,98		H 32		578412	159,75
	V 28		578336	146,98		U 16		578374	165,66
	V 35		578604	178,12		U 18		578376	165,66
	V 12 S (PR-2B)	Mini Z8	574748 R	124,51		U 20		578378	165,66
	V 15 S (PR-2B)	Mini Z8	574752 R	124,51		U 26 <sup>7)</sup>		578392	194,31
	V 18 S (PR-2B)	Mini Z8	574756 R	124,51		U 32		578382	194,31
	V 22 S (PR-2B)	Mini Z8	574758 R	124,51		U 40		578386	236,66
	V 28 S (PR-2B)	Mini Z8	574760 R	124,51	ALB	TH 16		578352 R	177,08
	V 35 S (PR-2B)	Mini Z8	574762 R	136,96	Sistema Multicapa	TH 20		578358 R	177,08
AHLSSELL	M 12		578310	146,98	para gas	TH 26		578362 R	177,08
A-press koppar M	M 15		578312	146,98		TH 32		578364	177,08
	M 18		578314	146,98		TH 16 S (PR-2B)**	Mini Z8	574782 R	124,51
	M 22		578316	146,98		TH 20 S (PR-2B)**	Mini Z8	574788 R	124,51
	M 28		578318	146,98		TH 26 S (PR-2B)**	Mini Z8	574794 R	124,51
	M 35		578390	178,12		TH 32 S (PR-2B)	Mini Z8	574798 R	136,96
	M 12 S (PR-2B)	Mini Z8	574736 R	124,51		H 16		578400	159,75
	M 15 S (PR-2B)	Mini Z8	574738 R	124,51		H 20		578406	159,75
	M 18 S (PR-2B)	Mini Z8	574740 R	124,51		H 26		578410	159,75
	M 22 S (PR-2B)	Mini Z8	574742 R	124,51		H 32		578412	159,75
	M 28 S (PR-2B)	Mini Z8	574744 R	124,51		U 16		578374	165,66
	M 35 S (PR-2B)	Mini Z8	574746 R	136,96		U 20		578378	165,66
AHLSSELL	V 12		578324	146,98		U 26 <sup>7)</sup>		578392	194,31
A-press koppar V	V 15		578328	146,98		U 32		578382	194,31
	V 18		578332	146,98	ALTECH Altech	RFz 12		578490	184,45
	V 22		578334	146,98		RFz 16		578492	184,45
	V 28		578336	146,98		RFz 20		578494	184,45
	V 35		578604	178,12		RFz 25		578496	184,45
	V 12 S (PR-2B)	Mini Z8	574748 R	124,51	APE MULTYGAS	TH 16		578352 R	177,08
	V 15 S (PR-2B)	Mini Z8	574752 R	124,51	Serie AP Gas	TH 20		578358 R	177,08
	V 18 S (PR-2B)	Mini Z8	574756 R	124,51		TH 26		578362 R	177,08
	V 22 S (PR-2B)	Mini Z8	574758 R	124,51		TH 32		578364	177,08
	V 28 S (PR-2B)	Mini Z8	574760 R	124,51		TH 16 S (PR-2B)**	Mini Z8	574782 R	124,51
	V 35 S (PR-2B)	Mini Z8	574762 R	136,96		TH 20 S (PR-2B)**	Mini Z8	574788 R	124,51
AHLSSELL	M 15		578312	146,98		TH 26 S (PR-2B)**	Mini Z8	574794 R	124,51
A-press rostfritt	M 18		578314	146,98		TH 32 S (PR-2B)	Mini Z8	574798 R	136,96
	M 22		578316	146,98	APE Serie AP	B 16		578468	193,28
	M 28		578318	146,98		B 20		578472	193,28
	M 35		578390	178,12		B 26		578474	213,00
	M 15 S (PR-2B)	Mini Z8	574738 R	124,51		H 16		578400	159,75
	M 18 S (PR-2B)	Mini Z8	574740 R	124,51		H 20		578406	159,75
	M 22 S (PR-2B)	Mini Z8	574742 R	124,51		H 26		578410	159,75
	M 28 S (PR-2B)	Mini Z8	574744 R	124,51		H 32		578412	159,75
	M 35 S (PR-2B)	Mini Z8	574746 R	136,96		TH 16		578352 R	177,08
AIRBEL	M 15		578312	146,98		TH 18		578356	177,08
PRESSCLIM	M 18		578314	146,98		TH 20		578358 R	177,08
	M 22		578316	146,98		TH 26		578362 R	177,08
	M 28		578318	146,98		TH 32		578364	177,08
	M 35		578390	178,12		TH 16 S (PR-2B)**	Mini Z8	574782 R	124,51
	M 15 S (PR-2B)	Mini Z8	574738 R	124,51		TH 18 S (PR-2B)**	Mini Z8	574786 R	124,51
	M 18 S (PR-2B)	Mini Z8	574740 R	124,51		TH 20 S (PR-2B)**	Mini Z8	574788 R	124,51
	M 22 S (PR-2B)	Mini Z8	574742 R	124,51		TH 26 S (PR-2B)**	Mini Z8	574794 R	124,51
	M 28 S (PR-2B)	Mini Z8	574744 R	124,51		TH 32 S (PR-2B)	Mini Z8	574798 R	136,96
	M 35 S (PR-2B)	Mini Z8	574746 R	136,96		U 16		578374	165,66
AIRBEL	M 15		578312	146,98		U 20		578378	165,66
SERTINOX	M 18		578314	146,98					
	M 22		578316	146,98					
	M 28		578318	146,98					
	M 35		578390	178,12					
	M 15 S (PR-2B)	Mini Z8	574738 R	124,51					
	M 18 S (PR-2B)	Mini Z8	574740 R	124,51					
	M 22 S (PR-2B)	Mini Z8	574742 R	124,51					
	M 28 S (PR-2B)	Mini Z8	574744 R	124,51					
	M 35 S (PR-2B)	Mini Z8	574746 R	136,96					

Pressfitting systems for gas installations must only be pressed with REMS pressing tongs Mini/pressing rings which are highlighted in yellow.

Observe the national regulations. Read and observe the instructions for use and the installation instructions of the system provider/manufacturer.

\*\* Can also be driven by the REMS Eco-Press manual radial press using the Z8 adapter tongs, see page 185. Observe the national regulations.

- <sup>1)</sup> Only pressing tongs from designation "108" (1<sup>st</sup> quarter of 2008), "208" (2<sup>nd</sup> quarter of 2008) etc. can be used. The designation is stamped on every pressing jaw.
- <sup>2)</sup> For taking suitable pressing inserts.
- <sup>3)</sup> Only pressing tongs from designation "117" (1<sup>st</sup> quarter of 2017), "217" (2<sup>nd</sup> quarter of 2017) etc. can be used. The designation is stamped on every pressing jaw.
- <sup>4)</sup> For pipes of the EN technical standard. Observe the instructions for use of the system provider/manufacturer.
- <sup>5)</sup> For pipes of the ASTM technical standard. Observe the instructions for use of the system provider/manufacturer.
- <sup>6)</sup> Only use Mini pressing tongs identified by "VMP ½" G" on the pressing jaws for gas installations.
- <sup>7)</sup> Previous designation: Mini C 26 pressing tongs

The suitability of REMS pressing tools for pressfitting systems: Date 27.10.2023. For the updated situation regarding suitability status check our website:

[www.rems.de](http://www.rems.de) > Downloads > Product catalogues, brochures > REMS Catalogue.

See page 183 for adapter tongs. Pressing tongs for additional pressfitting systems on request.







System	Pressing tongs Mini / pressing rings	Driven by adapter tongs	Art.-No.	€	System	Pressing tongs Mini / pressing rings	Driven by adapter tongs	Art.-No.	€	
CONEL	M 15		578312	146,98	Conex Bänninger >B< Flex	F 16		578456	168,68	
CONNECT INOX	M 18		578314	146,98		F 18		578458	168,68	
	M 22		578316	146,98		F 20		578460	168,68	
	V 15		578328	146,98		F 32		578464	182,48	
	V 18		578332	146,98		F 16 S (PR-2B)**	Mini Z8	574728 R	124,51	
	V 22		578334	146,98		F 20 S (PR-2B)**	Mini Z8	574730 R	124,51	
CONEL	F 16		578456	168,68		F 32 S (PR-2B)	Mini Z8	574734 R	136,96	
CONNECT	F 20		578460	168,68		H 16		578400	159,75	
MULTI	F 26		578462	182,48		H 18		578404	159,75	
	F 32		578464	182,48		H 20		578406	159,75	
	F 16 S (PR-2B)**	Mini Z8	574728 R	124,51		H 25		578408	159,75	
	F 20 S (PR-2B)**	Mini Z8	574730 R	124,51		H 32		578412	159,75	
	F 26 S (PR-2B)**	Mini Z8	574732 R	124,51		RFz 16		578492	184,45	
	F 32 S (PR-2B)**	Mini Z8	574734 R	136,96		RFz 18		578638	184,45	
	H 16		578400	159,75		RFz 20		578494	184,45	
	H 20		578406	159,75		RFz 25		578496	184,45	
	H 26		578410	159,75		RFz 32		578498	184,45	
	H 32		578412	159,75		TH 16		578352 R	177,08	
	TH 16		578352 R	177,08		TH 18		578356	177,08	
	TH 20		578358 R	177,08		TH 20		578358 R	177,08	
	TH 26		578362 R	177,08		TH 25		578360	177,08	
	TH 32		578364	177,08		TH 32		578364	177,08	
	TH 16 S (PR-2B)**	Mini Z8	574782 R	124,51		TH 16 S (PR-2B)**	Mini Z8	574782 R	124,51	
	TH 20 S (PR-2B)**	Mini Z8	574788 R	124,51		TH 18 S (PR-2B)**	Mini Z8	574786 R	124,51	
	TH 26 S (PR-2B)**	Mini Z8	574794 R	124,51		TH 20 S (PR-2B)**	Mini Z8	574788 R	124,51	
	TH 32 S (PR-2B)**	Mini Z8	574798 R	136,96		TH 32 S (PR-2B)	Mini Z8	574798 R	136,96	
	U 16		578374	165,66		U 16		578374	165,66	
	U 20		578378	165,66		U 18		578376	165,66	
(DN 26)	U 25		578380	165,66		U 20		578378	165,66	
	U 32		578382	194,31		U 25		578380	165,66	
	VP 16		578482	176,56		U 32		578382	194,31	
	VP 20		578484	176,56		CONEX BÄNNINGER >B< Flex Gas	F 16		578456	168,68
	VP 32		578488	195,25		F 18		578458	168,68	
CONEL	F 16		578456	168,68		F 20		578460	168,68	
CONNECT	F 20		578460	168,68		F 32		578464	182,48	
MV2	F 26		578462	182,48		F 16 S (PR-2B)**	Mini Z8	574728 R	124,51	
	F 32		578464	182,48	F 20 S (PR-2B)**	Mini Z8	574730 R	124,51		
	F 16 S (PR-2B)**	Mini Z8	574728 R	124,51	F 32 S (PR-2B)	Mini Z8	574734 R	136,96		
	F 20 S (PR-2B)**	Mini Z8	574730 R	124,51	H 16		578400	159,75		
	F 26 S (PR-2B)**	Mini Z8	574732 R	124,51	H 18		578404	159,75		
	F 32 S (PR-2B)**	Mini Z8	574734 R	136,96	H 20		578406	159,75		
	TH 16		578352 R	177,08	H 25		578408	159,75		
	TH 20		578358 R	177,08	H 32		578412	159,75		
	TH 26		578362 R	177,08	RFz 16		578492	184,45		
	TH 32		578364	177,08	RFz 18		578638	184,45		
	TH 16 S (PR-2B)**	Mini Z8	574782 R	124,51	RFz 20		578494	184,45		
	TH 20 S (PR-2B)**	Mini Z8	574788 R	124,51	RFz 25		578496	184,45		
	TH 26 S (PR-2B)**	Mini Z8	574794 R	124,51	RFz 32		578498	184,45		
	TH 32 S (PR-2B)**	Mini Z8	574798 R	136,96	TH 16		578352 R	177,08		
CONEX BÄNNINGER <A> Press Innox (304)	M 15		578312	146,98	TH 18		578356	177,08		
	M 18		578314	146,98	TH 20		578358 R	177,08		
	M 22		578316	146,98	TH 25		578360	177,08		
	M 28		578318	146,98	TH 32		578364	177,08		
	M 35		578390	178,12	TH 16 S (PR-2B)**	Mini Z8	574782 R	124,51		
	M 15 S (PR-2B)	Mini Z8	574738 R	124,51	TH 18 S (PR-2B)**	Mini Z8	574786 R	124,51		
	M 18 S (PR-2B)	Mini Z8	574740 R	124,51	TH 20 S (PR-2B)**	Mini Z8	574788 R	124,51		
	M 22 S (PR-2B)	Mini Z8	574742 R	124,51	TH 32 S (PR-2B)	Mini Z8	574798 R	136,96		
	M 28 S (PR-2B)	Mini Z8	574744 R	124,51	U 16		578374	165,66		
	M 35 S (PR-2B)	Mini Z8	574746 R	136,96	U 18		578376	165,66		
CONEX BÄNNINGER <A> Press Innox (316L)	M 15		578312	146,98	U 20		578378	165,66		
	M 18		578314	146,98	U 25		578380	165,66		
	M 22		578316	146,98	U 32		578382	194,31		
	M 28		578318	146,98	CONEX BÄNNINGER >B< MaxiPro	BMP ¼"		578700	175,53	
	M 35		578390	178,12	BMP ⅜"		578702	175,53		
	M 15 S (PR-2B)	Mini Z8	574738 R	124,51	BMP ½"		578704	175,53		
	M 18 S (PR-2B)	Mini Z8	574740 R	124,51	BMP ¾"		578706	175,53		
	M 22 S (PR-2B)	Mini Z8	574742 R	124,51	BMP 1"		578708	175,53		
	M 28 S (PR-2B)	Mini Z8	574744 R	124,51	BMP 1 ⅜"		578710	175,53		
	M 35 S (PR-2B)	Mini Z8	574746 R	136,96	BMP 1 ½"		578712	175,53		
					BMP 1 ⅝"		578714	175,53		

Pressfitting systems for gas installations must only be pressed with REMS pressing tongs Mini/pressing rings which are highlighted in yellow.

Observe the national regulations. Read and observe the instructions for use and the installation instructions of the system provider/manufacturer.

\*\* Can also be driven by the REMS Eco-Press manual radial press using the Z8 adapter tongs, see page 185. Observe the national regulations.

- 1) Only pressing tongs from designation "108" (1<sup>st</sup> quarter of 2008), "208" (2<sup>nd</sup> quarter of 2008) etc. can be used. The designation is stamped on every pressing jaw.
- 2) For taking suitable pressing inserts.
- 3) Only pressing tongs from designation "117" (1<sup>st</sup> quarter of 2017), "217" (2<sup>nd</sup> quarter of 2017) etc. can be used. The designation is stamped on every pressing jaw.
- 4) For pipes of the EN technical standard. Observe the instructions for use of the system provider/manufacturer.
- 5) For pipes of the ASTM technical standard. Observe the instructions for use of the system provider/manufacturer.
- 6) Only use Mini pressing tongs identified by "VMP ½" G" on the pressing jaws for gas installations.
- 7) Previous designation: Mini C 26 pressing tongs

The suitability of REMS pressing tools for pressfitting systems: Date 27.10.2023. For the updated situation regarding suitability status check our website:

[www.rems.de](http://www.rems.de) > Downloads > Product catalogues, brochures > REMS Catalogue.

See page 183 for adapter tongs. Pressing tongs for additional pressfitting systems on request.







# REMS pressing tongs Mini

## REMS pressing rings

## Accessories for REMS radial presses 22 kN

System	Pressing tongs Mini/ pressing rings	Driven by adapter tongs	Art.-No.	€	
Esta Rohr simplesta SH M	M 15		578312	146,98	
	M 18		578314	146,98	
	M 22		578316	146,98	
	M 28		578318	146,98	
	M 35		578390	178,12	
	M 15 S (PR-2B)	Mini Z8	574738 R	124,51	
	M 18 S (PR-2B)	Mini Z8	574740 R	124,51	
	M 22 S (PR-2B)	Mini Z8	574742 R	124,51	
	M 28 S (PR-2B)	Mini Z8	574744 R	124,51	
	M 35 S (PR-2B)	Mini Z8	574746 R	136,96	
	Esta Rohr simplesta ST M	M 15		578312	146,98
		M 18		578314	146,98
M 22			578316	146,98	
M 28			578318	146,98	
M 35			578390	178,12	
M 15 S (PR-2B)		Mini Z8	574738 R	124,51	
M 18 S (PR-2B)		Mini Z8	574740 R	124,51	
M 22 S (PR-2B)		Mini Z8	574742 R	124,51	
M 28 S (PR-2B)		Mini Z8	574744 R	124,51	
M 35 S (PR-2B)		Mini Z8	574746 R	136,96	
EUROTUBI EUROPA C-Steel Pressfitting System M-Profile <sup>1)</sup>		M 12		578310	146,98
		M 15		578312	146,98
	M 18		578314	146,98	
	M 22		578316	146,98	
	M 28		578318	146,98	
	M 35		578390	178,12	
	M 12 S (PR-2B)	Mini Z8	574736 R	124,51	
	M 15 S (PR-2B)	Mini Z8	574738 R	124,51	
	M 18 S (PR-2B)	Mini Z8	574740 R	124,51	
	M 22 S (PR-2B)	Mini Z8	574742 R	124,51	
	M 28 S (PR-2B)	Mini Z8	574744 R	124,51	
	M 35 S (PR-2B)	Mini Z8	574746 R	136,96	
EUROTUBI EUROPA Inox Pressfitting System M-Profile <sup>1)</sup>	M 15		578312	146,98	
	M 18		578314	146,98	
	M 22		578316	146,98	
	M 28		578318	146,98	
	M 35		578390	178,12	
	M 15 S (PR-2B)	Mini Z8	574738 R	124,51	
	M 18 S (PR-2B)	Mini Z8	574740 R	124,51	
	M 22 S (PR-2B)	Mini Z8	574742 R	124,51	
	M 28 S (PR-2B)	Mini Z8	574744 R	124,51	
	M 35 S (PR-2B)	Mini Z8	574746 R	136,96	
	Evans Components Presslok	VAU 15 (1/2" (OD 12,7 mm)		578630	151,86
		VAU 20 (3/4" (OD 19,1 mm)		578632	151,86
VAU 25 (1" (OD 25,4 mm)			578634	151,86	
<b>F</b>					
FAR Rubinetterie PRESSFAR	TH 14		578348	177,08	
	TH 16		578352 R	177,08	
	TH 17		578354	177,08	
	TH 18		578356	177,08	
	TH 20		578358 R	177,08	
	TH 25		578360	177,08	
	TH 26		578362 R	177,08	
	TH 32		578364	177,08	
	TH 40		578624	234,69	
	TH 14 S (PR-2B)**	Mini Z8	574778 R	124,51	
	TH 16 S (PR-2B)**	Mini Z8	574782 R	124,51	
	TH 17 S (PR-2B)**	Mini Z8	574784 R	124,51	
	TH 18 S (PR-2B)**	Mini Z8	574786 R	124,51	
	TH 20 S (PR-2B)**	Mini Z8	574788 R	124,51	
	TH 25 S (PR-2B)**	Mini Z8	574792 R	124,51	
	TH 26 S (PR-2B)**	Mini Z8	574794 R	124,51	
	TH 32 S (PR-2B)	Mini Z8	574798 R	136,96	
	H 14		578398	159,75	
	H 16		578400	159,75	
	H 18		578404	159,75	
	H 20		578406	159,75	
	H 26		578410	159,75	
	H 32		578412	159,75	
	U 14		578372	174,38	
	U 16		578374	165,66	
	U 18		578376	165,66	
	U 20		578378	165,66	
	U 25		578380	165,66	
	U 32		578382	194,31	
	U 40		578386	236,66	
	F.B.Q. BARONIO BQ PRESS SOLAR	V 12		578324	146,98
		V 14		578326	146,98
		V 15		578328	146,98
		V 16		578330	146,98
		V 18		578332	146,98
		V 22		578334	146,98
V 28			578336	146,98	
V 35			578604	178,12	
V 12 S (PR-2B)		Mini Z8	574748 R	124,51	
V 14 S (PR-2B)		Mini Z8	574800 R	124,51	
V 15 S (PR-2B)		Mini Z8	574752 R	124,51	
V 16 S (PR-2B)		Mini Z8	574802 R	124,51	
V 18 S (PR-2B)		Mini Z8	574756 R	124,51	
V 22 S (PR-2B)		Mini Z8	574758 R	124,51	
V 28 S (PR-2B)		Mini Z8	574760 R	124,51	
V 35 S (PR-2B)		Mini Z8	574762 R	136,96	

System	Pressing tongs Mini/ pressing rings	Driven by adapter tongs	Art.-No.	€	
F.B.Q. BARONIO BQ PRESS WATER	V 12		578324	146,98	
	V 14		578326	146,98	
	V 15		578328	146,98	
	V 16		578330	146,98	
	V 18		578332	146,98	
	V 22		578334	146,98	
	V 28		578336	146,98	
	V 35		578604	178,12	
	V 12 S (PR-2B)	Mini Z8	574748 R	124,51	
	V 14 S (PR-2B)	Mini Z8	574800 R	124,51	
	V 15 S (PR-2B)	Mini Z8	574752 R	124,51	
	V 16 S (PR-2B)	Mini Z8	574802 R	124,51	
F.B.Q. BARONIO BQ PRESS GAS	V 18 S (PR-2B)	Mini Z8	574756 R	124,51	
	V 22 S (PR-2B)	Mini Z8	574758 R	124,51	
	V 28 S (PR-2B)	Mini Z8	574760 R	124,51	
	V 35 S (PR-2B)	Mini Z8	574762 R	136,96	
	V 12		578324	146,98	
	V 14		578326	146,98	
	V 15		578328	146,98	
	V 16		578330	146,98	
	V 18		578332	146,98	
	V 22		578334	146,98	
	V 28		578336	146,98	
	V 35		578604	178,12	
FERC OFLOOR DUO Press FERCO PEX	Rfz 16		578492	184,45	
	Rfz 20		578494	184,45	
	Rfz 25		578496	184,45	
	Rfz 32		578498	184,45	
	TH 16		578352 R	177,08	
	TH 20		578358 R	177,08	
	TH 25		578360	177,08	
	TH 32		578364	177,08	
	TH 40		578624	234,69	
	TH 16 S (PR-2B)**	Mini Z8	574782 R	124,51	
	TH 20 S (PR-2B)**	Mini Z8	574788 R	124,51	
	TH 25 S (PR-2B)**	Mini Z8	574792 R	124,51	
FERC OFLOOR DUO Press MULTIFER	TH 32 S (PR-2B)	Mini Z8	574798 R	136,96	
	Rfz 16		578492	184,45	
	Rfz 20		578494	184,45	
	Rfz 25		578496	184,45	
	Rfz 32		578498	184,45	
	TH 16		578352 R	177,08	
	TH 20		578358 R	177,08	
	TH 25		578360	177,08	
	TH 32		578364	177,08	
	TH 40		578624	234,69	
	TH 16 S (PR-2B)**	Mini Z8	574782 R	124,51	
	TH 20 S (PR-2B)**	Mini Z8	574788 R	124,51	
FERRO systems BRASELLI GPF GAS	TH 25 S (PR-2B)**	Mini Z8	574792 R	124,51	
	TH 32 S (PR-2B)	Mini Z8	574798 R	136,96	
	U 16		578374	165,66	
	U 18		578376	165,66	
	U 20		578378	165,66	
	U 25		578380	165,66	
	U 32		578382	194,31	
	U 40		578386	236,66	
	TH 16		578352 R	177,08	
	TH 20		578358 R	177,08	
	TH 25		578360	177,08	
	TH 16 S (PR-2B)**	Mini Z8	574782 R	124,51	
FERRO systems BRASELLI GPF PRESS Pressfitting PEX y MULTICAPA	TH 20 S (PR-2B)**	Mini Z8	574788 R	124,51	
	TH 25 S (PR-2B)**	Mini Z8	574792 R	124,51	
	TH 32 S (PR-2B)	Mini Z8	574798 R	136,96	
	U 16		578374	165,66	
	U 18		578376	165,66	
	U 20		578378	165,66	
	U 25		578380	165,66	
	U 32		578382	194,31	
	U 40		578386	236,66	
	TH 16 S (PR-2B)**	Mini Z8	574782 R	124,51	
	FERRO systems BRASELLI GPF PRESS Pressfitting PEX FILINOX Instalpress Steel	TH 20 S (PR-2B)**	Mini Z8	574788 R	124,51
		Rfz 16		578492	184,45
Rfz 20			578494	184,45	
Rfz 25			578496	184,45	
Rfz 32			578498	184,45	
M 15			578312	146,98	
M 18			578314	146,98	
M 22			578316	146,98	
M 28			578318	146,98	
M 35			578390	178,12	
M 15 S (PR-2B)		Mini Z8	574738 R	124,51	
M 18 S (PR-2B)		Mini Z8	574740 R	124,51	
FERRO systems BRASELLI GPF PRESS Pressfitting PEX MULTICAPA	M 22 S (PR-2B)	Mini Z8	574742 R	124,51	
	M 28 S (PR-2B)	Mini Z8	574744 R	124,51	
	M 35 S (PR-2B)	Mini Z8	574746 R	136,96	















**REMS pressing tongs Mini**  
**REMS pressing rings**

Accessories for REMS radial presses 22 kN

System	Pressing tongs Mini / pressing rings	Driven by adapter tongs	Art.-No.	€		
IVAR Plastic Multi Press PMP	TH 16		578352 R	177,08		
	TH 20		578358 R	177,08		
	TH 25		578360	177,08		
	TH 26		578362 R	177,08		
	TH 32		578364	177,08		
	TH 16 S (PR-2B)**	Mini Z8	574782 R	124,51		
	TH 20 S (PR-2B)**	Mini Z8	574788 R	124,51		
	TH 25 S (PR-2B)**	Mini Z8	574792 R	124,51		
	TH 26 S (PR-2B)**	Mini Z8	574794 R	124,51		
	TH 32 S (PR-2B)	Mini Z8	574798 R	136,96		
	F 16		578456	168,68		
	F 20		578460	168,68		
	F 26		578462	182,48		
	F 32		578464	182,48		
	F 16 S (PR-2B)**	Mini Z8	574728 R	124,51		
	F 20 S (PR-2B)**	Mini Z8	574730 R	124,51		
	F 26 S (PR-2B)**	Mini Z8	574732 R	124,51		
	F 32 S (PR-2B)	Mini Z8	574734 R	136,96		
	H 16		578400	159,75		
	H 20		578406	159,75		
	H 25		578408	159,75		
	H 26		578410	159,75		
	H 32		578412	159,75		
	U 16		578374	165,66		
	U 20		578378	165,66		
	U 25		578380	165,66		
	U 26 <sup>7)</sup>		578392	194,31		
	U 32		578382	194,31		
	B 16		578468	193,28		
	B 20		578472	193,28		
	B 26		578474	213,00		
	B 32		578476	213,00		
	IVAR Plastic Multi Press Leak (PMPL)	TH 16		578352 R	177,08	
		TH 20		578358 R	177,08	
		TH 26		578362 R	177,08	
		TH 32		578364	177,08	
		TH 16 S (PR-2B)**	Mini Z8	574782 R	124,51	
		TH 20 S (PR-2B)**	Mini Z8	574788 R	124,51	
		TH 26 S (PR-2B)**	Mini Z8	574794 R	124,51	
		TH 32 S (PR-2B)	Mini Z8	574798 R	136,96	
		F 16		578456	168,68	
		F 20		578460	168,68	
		F 26		578462	182,48	
F 32			578464	182,48		
F 16 S (PR-2B)**		Mini Z8	574728 R	124,51		
F 20 S (PR-2B)**		Mini Z8	574730 R	124,51		
F 26 S (PR-2B)**		Mini Z8	574732 R	124,51		
F 32 S (PR-2B)		Mini Z8	574734 R	136,96		
H 16			578400	159,75		
H 20			578406	159,75		
H 26			578410	159,75		
H 32			578412	159,75		
U 16			578374	165,66		
U 20			578378	165,66		
U 26 <sup>7)</sup>			578392	194,31		
U 32			578382	194,31		
B 16			578468	193,28		
B 20			578472	193,28		
B 26			578474	213,00		
B 32			578476	213,00		
IVT Edelstahl- Presssystem		M 15		578312	146,98	
		M 18		578314	146,98	
		M 22		578316	146,98	
		M 28		578318	146,98	
		M 35		578390	178,12	
		M 15 S (PR-2B)	Mini Z8	574738 R	124,51	
		M 18 S (PR-2B)	Mini Z8	574740 R	124,51	
		M 22 S (PR-2B)	Mini Z8	574742 R	124,51	
		M 28 S (PR-2B)	Mini Z8	574744 R	124,51	
		M 35 S (PR-2B)	Mini Z8	574746 R	136,96	
		IVT PRIPRESS	TH 16		578352 R	177,08
			TH 20		578358 R	177,08
			TH 26		578362 R	177,08
TH 32				578364	177,08	
TH 40				578624	234,69	
TH 16 S (PR-2B)**	Mini Z8		574782 R	124,51		
TH 20 S (PR-2B)**	Mini Z8		574788 R	124,51		
TH 26 S (PR-2B)**	Mini Z8		574794 R	124,51		
TH 32 S (PR-2B)	Mini Z8		574798 R	136,96		

System	Pressing tongs Mini / pressing rings	Driven by adapter tongs	Art.-No.	€	
<b>J</b>					
Jäger - Aquatec Aquatec H	H 14		578398	159,75	
	H 16		578400	159,75	
	H 17		578402	159,75	
	H 18		578404	159,75	
	H 20		578406	159,75	
	H 26		578410	159,75	
	H 32		578412	159,75	
	U 40		578386	236,66	
	Jäger - Aquatec C-Stahl Press Typ M	M 15		578312	146,98
		M 18		578314	146,98
		M 22		578316	146,98
		M 28		578318	146,98
		M 35		578390	178,12
	M 15 S (PR-2B)	Mini Z8	574738 R	124,51	
		M 18 S (PR-2B)	Mini Z8	574740 R	124,51
		M 22 S (PR-2B)	Mini Z8	574742 R	124,51
		M 28 S (PR-2B)	Mini Z8	574744 R	124,51
		M 35 S (PR-2B)	Mini Z8	574746 R	136,96
Jäger - Aquatec Edelstahl Press Typ M		M 15		578312	146,98
		M 18		578314	146,98
		M 22		578316	146,98
	M 28		578318	146,98	
	M 35		578390	178,12	
	M 15 S (PR-2B)	Mini Z8	574738 R	124,51	
M 18 S (PR-2B)		Mini Z8	574740 R	124,51	
M 22 S (PR-2B)		Mini Z8	574742 R	124,51	
M 28 S (PR-2B)		Mini Z8	574744 R	124,51	
M 35 S (PR-2B)		Mini Z8	574746 R	136,96	
Jäger - Aquatec Kupfer Press Typ V		V 15		578328	146,98
		V 18		578332	146,98
		V 22		578334	146,98
		V 28		578336	146,98
		V 35		578604	178,12
	V 15 S (PR-2B)	Mini Z8	574752 R	124,51	
	V 18 S (PR-2B)	Mini Z8	574756 R	124,51	
	V 22 S (PR-2B)	Mini Z8	574758 R	124,51	
V 28 S (PR-2B)	Mini Z8	574760 R	124,51		
	V 35 S (PR-2B)	Mini Z8	574762 R	136,96	
	Jansen AG JANSEN COMISA	TH 14		578348	177,08
		TH 16		578352 R	177,08
		TH 20		578358 R	177,08
		TH 26		578362 R	177,08
		TH 32		578364	177,08
		TH 40		578624	234,69
		TH 14 S (PR-2B)**	Mini Z8	574778 R	124,51
		TH 16 S (PR-2B)**	Mini Z8	574782 R	124,51
		TH 20 S (PR-2B)**	Mini Z8	574788 R	124,51
		TH 26 S (PR-2B)**	Mini Z8	574794 R	124,51
	TH 32 S (PR-2B)	Mini Z8	574798 R	136,96	
Jaraflex- Presssystem	TH 14		578348	177,08	
	TH 16		578352 R	177,08	
	TH 17		578354	177,08	
	TH 18		578356	177,08	
	TH 20		578358 R	177,08	
	TH 25		578360	177,08	
	TH 26		578362 R	177,08	
	TH 32		578364	177,08	
	TH 40		578624	234,69	
	TH 14 S (PR-2B)**	Mini Z8	574778 R	124,51	
	TH 16 S (PR-2B)**	Mini Z8	574782 R	124,51	
	TH 17 S (PR-2B)**	Mini Z8	574784 R	124,51	
	TH 18 S (PR-2B)**	Mini Z8	574786 R	124,51	
	TH 20 S (PR-2B)**	Mini Z8	574788 R	124,51	
TH 25 S (PR-2B)**	Mini Z8	574792 R	124,51		
TH 26 S (PR-2B)**	Mini Z8	574794 R	124,51		
TH 32 S (PR-2B)	Mini Z8	574798 R	136,96		
JUNGWOOD	VUS ½" (OD 15,9 mm)		578566	177,50	
	VUS ¾" (OD 22,2 mm)		578568	177,50	
	VUS 1" (OD 28,6 mm)		578570	177,50	
	VUS 1¼" (OD 34,9 mm)		578606	177,50	

Pressfitting systems for gas installations must only be pressed with REMS pressing tongs Mini/pressing rings which are highlighted in yellow.

Observe the national regulations. Read and observe the instructions for use and the installation instructions of the system provider/manufacturer.

\*\* Can also be driven by the REMS Eco-Press manual radial press using the Z8 adapter tongs, see page 185. Observe the national regulations.

- Only pressing tongs from designation "108" (1<sup>st</sup> quarter of 2008), "208" (2<sup>nd</sup> quarter of 2008) etc. can be used. The designation is stamped on every pressing jaw.
- For taking suitable pressing inserts.
- Only pressing tongs from designation "117" (1<sup>st</sup> quarter of 2017), "217" (2<sup>nd</sup> quarter of 2017) etc. can be used. The designation is stamped on every pressing jaw.
- For pipes of the EN technical standard. Observe the instructions for use of the system provider/manufacturer.
- For pipes of the ASTM technical standard. Observe the instructions for use of the system provider/manufacturer.
- Only use Mini pressing tongs identified by "VMP ½" G" on the pressing jaws for gas installations.
- Previous designation: Mini C 26 pressing tongs

The suitability of REMS pressing tools for pressfitting systems: Date 27.10.2023. For the updated situation regarding suitability status check our website: [www.rems.de](http://www.rems.de) > Downloads > Product catalogues, brochures > REMS Catalogue. See page 183 for adapter tongs. Pressing tongs for additional pressfitting systems on request.











# REMS pressing tongs Mini REMS pressing rings

## Accessories for REMS radial presses 22 kN

System	Pressing tongs Mini / pressing rings	Driven by adapter tongs	Art.-No.	€	System	Pressing tongs Mini / pressing rings	Driven by adapter tongs	Art.-No.	€
Redi Nicoll Fluxo Gas	TH 16		578352 R	177,08	Rubinetterie	M 15		578312	146,98
	TH 20		578358 R	177,08	Bresciane	M 18		578314	146,98
	TH 26		578362 R	177,08	Bonomi	M 22		578316	146,98
	TH 16 S (PR-2B)**	Mini Z8	574782 R	124,51	TURBO STEEL	M 28		578318	146,98
	TH 20 S (PR-2B)**	Mini Z8	574788 R	124,51	M 35		578390	178,12	
	TH 26 S (PR-2B)**	Mini Z8	574794 R	124,51	M 15 S (PR-2B)	Mini Z8	574738 R	124,51	
RIFENG LD PRESS FITTING (F8)	LD 16		578652	182,69	M 18 S (PR-2B)	Mini Z8	574740 R	124,51	
	LD 20		578654	182,69	M 22 S (PR-2B)	Mini Z8	574742 R	124,51	
	LD 25		578656	182,69	M 28 S (PR-2B)	Mini Z8	574744 R	124,51	
RIFENG U PRESS FITTING (F5)	U 14		578372	174,38	M 35 S (PR-2B)	Mini Z8	574746 R	136,96	
	U 16		578374	165,66	Rubinetterie	B 14		578466	193,28
	U 18		578376	165,66	Bresciane	B 16		578468	193,28
	U 20		578378	165,66	Bonomi	B 18		578470	193,28
	U 25		578380	165,66	TURBO PRESS	B 20		578472	193,28
	U 32		578382	194,31	B 26		578474	213,00	
RIFENG TH PRESS FITTING (F9)	U 40		578386	236,66	B 32		578476	213,00	
	TH 16		578352 R	177,08	H 14		578398	159,75	
	TH 20		578358 R	177,08	H 16		578400	159,75	
	TH 25		578360	177,08	H 18		578404	159,75	
	TH 26		578362 R	177,08	H 20		578406	159,75	
RIQUIER A SERTIR	TH 32		578364	177,08	H 26		578410	159,75	
	TH 40		578624	234,69	H 32		578412	159,75	
	RFz 12		578490	184,45	TH 14		578348	177,08	
	RFz 16		578492	184,45	TH 16		578352 R	177,08	
	RFz 20		578494	184,45	TH 18		578356	177,08	
RIQUIER Système multicouche	RFz 25		578496	184,45	TH 20		578358 R	177,08	
	TH 16		578352 R	177,08	TH 26		578362 R	177,08	
	TH 20		578358 R	177,08	TH 32		578364	177,08	
	TH 26		578362 R	177,08	TH 40		578624	234,69	
	TH 32		578364	177,08	TH 16 S (PR-2B)**	Mini Z8	574782 R	124,51	
	TH 40		578624	234,69	TH 20 S (PR-2B)**	Mini Z8	574788 R	124,51	
	TH 16 S (PR-2B)**	Mini Z8	574782 R	124,51	TH 26 S (PR-2B)**	Mini Z8	574794 R	124,51	
	TH 20 S (PR-2B)**	Mini Z8	574788 R	124,51	TH 32 S (PR-2B)	Mini Z8	574798 R	136,96	
	TH 26 S (PR-2B)**	Mini Z8	574794 R	124,51	U 14		578372	174,38	
	TH 32 S (PR-2B)	Mini Z8	574798 R	136,96	U 16		578374	165,66	
Roth PressCheck	U 20		578378	165,66	U 18		578376	165,66	
	U 32		578382	194,31	U 20		578378	165,66	
	U 40		578386	236,66	U 26 <sup>7)</sup>		578392	194,31	
	RN 14		578434	165,66	U 32		578382	194,31	
	RN 16		578454	165,66	Rubinetterie	TH 16		578352 R	177,08
	RN 17		578436	165,66	Bresciane	TH 20		578358 R	177,08
	RN 20		578438	165,66	Bonomi	TH 26		578362 R	177,08
	RN 25/26		578440	165,66	TURBO PRESS	TH 32		578364	177,08
	RN 32		578442	194,31	GAS	TH 16 S (PR-2B)**	Mini Z8	574782 R	124,51
						TH 20 S (PR-2B)**	Mini Z8	574788 R	124,51
Rubinetterie	M 15		578312	146,98	TH 26 S (PR-2B)**	Mini Z8	574794 R	124,51	
Bresciane	M 18		578314	146,98	TH 32 S (PR-2B)	Mini Z8	574798 R	136,96	
Bonomi	M 22		578316	146,98					
TURBO CuNi	M 28		578318	146,98					
	M 35		578390	178,12					
	M 15 S (PR-2B)	Mini Z8	574738 R	124,51					
	M 18 S (PR-2B)	Mini Z8	574740 R	124,51					
	M 22 S (PR-2B)	Mini Z8	574742 R	124,51					
	M 28 S (PR-2B)	Mini Z8	574744 R	124,51					
	M 35 S (PR-2B)	Mini Z8	574746 R	136,96					
Rubinetterie	M 15		578312	146,98					
Bresciane	M 18		578314	146,98					
Bonomi	M 22		578316	146,98					
TURBO INOX	M 28		578318	146,98					
	M 35		578390	178,12					
	M 15 S (PR-2B)	Mini Z8	574738 R	124,51					
	M 18 S (PR-2B)	Mini Z8	574740 R	124,51					
	M 22 S (PR-2B)	Mini Z8	574742 R	124,51					
	M 28 S (PR-2B)	Mini Z8	574744 R	124,51					
	M 35 S (PR-2B)	Mini Z8	574746 R	136,96					
Rubinetterie	M 15		578312	146,98					
Bresciane	M 18		578314	146,98					
Bonomi	M 22		578316	146,98					
TURBO INOX GAS	M 28		578318	146,98					
	M 35		578390	178,12					
	M 15 S (PR-2B)	Mini Z8	574738 R	124,51					
	M 18 S (PR-2B)	Mini Z8	574740 R	124,51					
	M 22 S (PR-2B)	Mini Z8	574742 R	124,51					
	M 28 S (PR-2B)	Mini Z8	574744 R	124,51					
	M 35 S (PR-2B)	Mini Z8	574746 R	136,96					

S

Pressfitting systems for gas installations must only be pressed with REMS pressing tongs Mini/pressing rings which are highlighted in yellow.

Observe the national regulations. Read and observe the instructions for use and the installation instructions of the system provider/manufacturer.

\*\* Can also be driven by the REMS Eco-Press manual radial press using the Z8 adapter tongs, see page 185. Observe the national regulations.

1) Only pressing tongs from designation "108" (1<sup>st</sup> quarter of 2008), "208" (2<sup>nd</sup> quarter of 2008) etc. can be used. The designation is stamped on every pressing jaw.

2) For taking suitable pressing inserts.

3) Only pressing tongs from designation "117" (1<sup>st</sup> quarter of 2017), "217" (2<sup>nd</sup> quarter of 2017) etc. can be used. The designation is stamped on every pressing jaw.

4) For pipes of the EN technical standard. Observe the instructions for use of the system provider/manufacturer.

5) For pipes of the ASTM technical standard. Observe the instructions for use of the system provider/manufacturer.

6) Only use Mini pressing tongs identified by "VMP ½ G" on the pressing jaws for gas installations.

7) Previous designation: Mini C 26 pressing tongs

The suitability of REMS pressing tools for pressfitting systems: Date 27.10.2023. For the updated situation regarding suitability status check our website: [www.rems.de](http://www.rems.de) > Downloads > Product catalogues, brochures > REMS Catalogue.

See page 183 for adapter tongs. Pressing tongs for additional pressfitting systems on request.







# REMS pressing tongs Mini REMS pressing rings

## Accessories for REMS radial presses 22 kN

System	Pressing tongs Mini/ pressing rings	Driven by adapter tongs	Art.-No.	€	
SANHA PURAPRESS Serie 8000	SA 12		578510	256,39	
	SA 14		578512	256,39	
	SA 15		578514	176,56	
	SA 16		578516	176,56	
	SA 18		578518	176,56	
	SA 22		578520	176,56	
	SA 28		578522	176,56	
	M 12 <sup>1)</sup>		578310	146,98	
	M 15 <sup>1)</sup>		578312	146,98	
	M 18 <sup>1)</sup>		578314	146,98	
	M 22 <sup>1)</sup>		578316	146,98	
	M 28 <sup>1)</sup>		578318	146,98	
	M 35 <sup>1)</sup>		578390	178,12	
	M 12 S (PR-2B)	Mini Z8	574736 R	124,51	
	M 15 S (PR-2B)	Mini Z8	574738 R	124,51	
	M 18 S (PR-2B)	Mini Z8	574740 R	124,51	
	M 22 S (PR-2B)	Mini Z8	574742 R	124,51	
	M 28 S (PR-2B)	Mini Z8	574744 R	124,51	
	M 35 S (PR-2B)	Mini Z8	574746 R	136,96	
	V 12		578324	146,98	
	V 14		578326	146,98	
	VG 14		578338	146,98	
	V 15 <sup>1)</sup>		578328	146,98	
	V 16		578330	146,98	
	VG 16		578340	146,98	
	V 18 <sup>1)</sup>		578332	146,98	
	V 22 <sup>1)</sup>		578334	146,98	
	V 28		578336	146,98	
	V 35		578604	178,12	
	V 12 S (PR-2B)	Mini Z8	574748 R	124,51	
	VG 14 S (PR-2B)	Mini Z8	574750 R	124,51	
	V 15 S (PR-2B)	Mini Z8	574752 R	124,51	
	VG 16 S (PR-2B)	Mini Z8	574754 R	124,51	
	V 18 S (PR-2B)	Mini Z8	574756 R	124,51	
	V 22 S (PR-2B)	Mini Z8	574758 R	124,51	
	V 28 S (PR-2B)	Mini Z8	574760 R	124,51	
	V 35 S (PR-2B)	Mini Z8	574762 R	136,96	
	SANHA-Therm Serie 24000	SA 12		578510	256,39
		SA 15		578514	176,56
		SA 18		578518	176,56
		SA 22		578520	176,56
		SA 28		578522	176,56
		M 12		578310	146,98
M 15 <sup>1)</sup>			578312	146,98	
M 18 <sup>1)</sup>			578314	146,98	
M 22 <sup>1)</sup>			578316	146,98	
M 28			578318	146,98	
M 35			578390	178,12	
M 12 S (PR-2B)		Mini Z8	574736 R	124,51	
M 15 S (PR-2B)		Mini Z8	574738 R	124,51	
M 18 S (PR-2B)		Mini Z8	574740 R	124,51	
M 22 S (PR-2B)		Mini Z8	574742 R	124,51	
M 28 S (PR-2B)		Mini Z8	574744 R	124,51	
M 35 S (PR-2B)		Mini Z8	574746 R	136,96	
V 12			578324	146,98	
V 15 <sup>1)</sup>			578328	146,98	
V 18 <sup>1)</sup>			578332	146,98	
V 22 <sup>1)</sup>			578334	146,98	
V 28			578336	146,98	
V 35			578604	178,12	
V 12 S (PR-2B)		Mini Z8	574748 R	124,51	
V 15 S (PR-2B)		Mini Z8	574752 R	124,51	
V 18 S (PR-2B)		Mini Z8	574756 R	124,51	
V 22 S (PR-2B)		Mini Z8	574758 R	124,51	
V 28 S (PR-2B)		Mini Z8	574760 R	124,51	
V 35 S (PR-2B)		Mini Z8	574762 R	136,96	
SANHA-Therm Industry Serie 28000		SA 12		578510	256,39
		SA 15		578514	176,56
		SA 18		578518	176,56
		SA 22		578520	176,56
		SA 28		578522	176,56
		M 12		578310	146,98
		M 15 <sup>1)</sup>		578312	146,98
		M 18 <sup>1)</sup>		578314	146,98
		M 22 <sup>1)</sup>		578316	146,98
		M 28		578318	146,98
		M 35		578390	178,12
		M 12 S (PR-2B)	Mini Z8	574736 R	124,51
		M 15 S (PR-2B)	Mini Z8	574738 R	124,51
		M 18 S (PR-2B)	Mini Z8	574740 R	124,51
	M 22 S (PR-2B)	Mini Z8	574742 R	124,51	
	M 28 S (PR-2B)	Mini Z8	574744 R	124,51	
	M 35 S (PR-2B)	Mini Z8	574746 R	136,96	
	V 12		578324	146,98	
	V 15 <sup>1)</sup>		578328	146,98	
	V 18 <sup>1)</sup>		578332	146,98	
	V 22 <sup>1)</sup>		578334	146,98	
	V 28		578336	146,98	
	V 35		578604	178,12	
	V 12 S (PR-2B)	Mini Z8	574748 R	124,51	
	V 15 S (PR-2B)	Mini Z8	574752 R	124,51	
	V 18 S (PR-2B)	Mini Z8	574756 R	124,51	
	V 22 S (PR-2B)	Mini Z8	574758 R	124,51	
	V 28 S (PR-2B)	Mini Z8	574760 R	124,51	
	V 35 S (PR-2B)	Mini Z8	574762 R	136,96	

System	Pressing tongs Mini/ pressing rings	Driven by adapter tongs	Art.-No.	€
SANITOP PERMATUBO INOX	M 15		578312	146,98
	M 18		578314	146,98
	M 22		578316	146,98
	M 28		578318	146,98
	M 35		578390	178,12
	M 15 S (PR-2B)	Mini Z8	574738 R	124,51
	M 18 S (PR-2B)	Mini Z8	574740 R	124,51
	M 22 S (PR-2B)	Mini Z8	574742 R	124,51
	M 28 S (PR-2B)	Mini Z8	574744 R	124,51
	M 35 S (PR-2B)	Mini Z8	574746 R	136,96
SANPRO THPRESS	TH 16		578352 R	177,08
	TH 20		578358 R	177,08
	TH 26		578362 R	177,08
	TH 32		578364	177,08
	TH 16 S (PR-2B)**	Mini Z8	574782 R	124,51
	TH 20 S (PR-2B)**	Mini Z8	574788 R	124,51
SATEC SK VITerm	TH 16		578352 R	177,08
	TH 18		578356	177,08
	TH 20		578358 R	177,08
	TH 26		578362 R	177,08
	TH 32		578364	177,08
	U 40		578386	236,66
SAVEUR REFLEX PEX Water	TH 16		578352 R	177,08
	TH 20		578358 R	177,08
	TH 25		578360	177,08
SAVEUR REFLEX PEX-AL-PEX Gas	TH 16		578352 R	177,08
	TH 20		578358 R	177,08
	TH 25		578360	177,08
Schütz duo-flex tri-o-flex	TH 14		578348	177,08
	TH 16		578352 R	177,08
	TH 17		578354	177,08
	TH 20		578358 R	177,08
	TH 25		578360	177,08
	TH 16 S (PR-2B)**	Mini Z8	574782 R	124,51
Schwer Fittings AQUApress	TH 20 S (PR-2B)**	Mini Z8	574788 R	124,51
	M 12		578310	146,98
	M 15		578312	146,98
	M 18		578314	146,98
	M 22		578316	146,98
	M 28		578318	146,98
Seppelfricke > Aalberts integrated piping systems	M 35		578390	178,12
	M 12 S (PR-2B)	Mini Z8	574736 R	124,51
	M 15 S (PR-2B)	Mini Z8	574738 R	124,51
	M 18 S (PR-2B)	Mini Z8	574740 R	124,51
	M 22 S (PR-2B)	Mini Z8	574742 R	124,51
	M 28 S (PR-2B)	Mini Z8	574744 R	124,51
	M 35 S (PR-2B)	Mini Z8	574746 R	136,96
	TH 14		578348	177,08
	TH 16		578352 R	177,08
	TH 20		578358 R	177,08
TH 26		578362 R	177,08	
TH 32		578364	177,08	
SESTA SESTA GAS	H 16		578400	159,75
	H 20		578406	159,75
	TH 14		578348	177,08
	TH 16		578352 R	177,08
	TH 18		578356	177,08
	TH 20		578358 R	177,08
SESTA sistema multistrato	TH 26		578362 R	177,08
	TH 32		578364	177,08
	TH 16		578352 R	177,08
	TH 18		578356	177,08
	TH 20		578358 R	177,08
	TH 26		578362 R	177,08
	TH 32		578364	177,08
	TH 40		578624	234,69
	U 16		578374	165,66
	U 20		578378	165,66
SIGMA LI Premium	TH 16		578352 R	177,08
	TH 20		578358 R	177,08
	TH 25		578360	177,08
	TH 32		578364	177,08
	TH 16 S (PR-2B)**	Mini Z8	574782 R	124,51
	TH 20 S (PR-2B)**	Mini Z8	574788 R	124,51
	TH 25 S (PR-2B)**	Mini Z8	574792 R	124,51
	TH 32 S (PR-2B)	Mini Z8	574798 R	136,96
	U 16		578374	165,66
	U 20		578378	165,66
SLOVARM PEX-THERM	U 25		578380	165,66
	U 32		578382	194,31
	U 16		578374	165,66
	U 20		578378	165,66
	H 26		578410	159,75
	U 32		578382	194,31
	H 16		578400	159,75
	H 20		578406	159,75
	H 26		578410	159,75
	H 32		578412	159,75

# REMS pressing tongs Mini REMS pressing rings

## Accessories for REMS radial presses 22 kN

System	Pressing tongs Mini / pressing rings	Driven by adapter tongs	Art.-No.	€	System	Pressing tongs Mini / pressing rings	Driven by adapter tongs	Art.-No.	€			
STANDARD HIDRAULICA MultiStandard	H 16		578400	159,75	TDM BRASS Serie 2600	H 16		578400	159,75			
	H 20		578406	159,75		H 18		578404	159,75			
	H 25		578408	159,75		H 20		578406	159,75			
	H 32		578412	159,75		H 25		578408	159,75			
	RFz 16		578492	184,45		H 26		578410	159,75			
	RFz 20		578494	184,45		H 32		578412	159,75			
	RFz 25		578496	184,45		TH 16		578352 R	177,08			
	RFz 32		578498	184,45		TH 18		578356	177,08			
	TH 16		578352 R	177,08		TH 20		578358 R	177,08			
	TH 20		578358 R	177,08		TH 25		578360	177,08			
	TH 25		578360	177,08		TH 26		578362 R	177,08			
	TH 32		578364	177,08		THL 32		578368	177,08			
	TH 16 S (PR-2B)**	Mini Z8	574782 R	124,51		TH 16 S (PR-2B)**	Mini Z8	574782 R	124,51			
	TH 20 S (PR-2B)**	Mini Z8	574788 R	124,51		TH 18 S (PR-2B)**	Mini Z8	574786 R	124,51			
	TH 25 S (PR-2B)**	Mini Z8	574792 R	124,51		TH 20 S (PR-2B)**	Mini Z8	574788 R	124,51			
	TH 32 S (PR-2B)	Mini Z8	574798 R	136,96		TH 25 S (PR-2B)**	Mini Z8	574792 R	124,51			
	U 16		578374	165,66		TH 26 S (PR-2B)**	Mini Z8	574794 R	124,51			
	U 18		578376	165,66		U 16		578374	165,66			
	U 20		578378	165,66		U 18		578376	165,66			
	U 25		578380	165,66		U 20		578378	165,66			
	U 32		578382	194,31		U 25		578380	165,66			
	U 40		578386	236,66		U 26 <sup>7)</sup>		578392	194,31			
	steeltrade Presssystem Edelstahl Kontur M	M 15		578312		146,98	TDM BRASS Serie 1700 gas	TH 16		578352 R	177,08	
M 18 <sup>1)</sup>			578314	146,98	TH 20			578358 R	177,08			
M 22			578316	146,98	TH 26			578362 R	177,08			
M 28 <sup>1)</sup>			578318	146,98	THL 32			578368	177,08			
M 35			578390	178,12	TH 16 S (PR-2B)**	Mini Z8		574782 R	124,51			
M 15 S (PR-2B)		Mini Z8	574738 R	124,51	TH 20 S (PR-2B)**	Mini Z8		574788 R	124,51			
M 18 S (PR-2B)		Mini Z8	574740 R	124,51	TH 26 S (PR-2B)**	Mini Z8		574794 R	124,51			
M 22 S (PR-2B)		Mini Z8	574742 R	124,51	U 16			578374	165,66			
M 28 S (PR-2B)		Mini Z8	574744 R	124,51	U 18			578376	165,66			
M 35 S (PR-2B)		Mini Z8	574746 R	136,96	U 20			578378	165,66			
STELBI Polikraft		H 16		578400	159,75	TermoConcept TC-PRESS		Basic E01 <sup>1)</sup>		578618	305,17	
		H 20		578406	159,75			THERMOLUTZ	H 14		578398	159,75
		H 26		578410	159,75				H 16		578400	159,75
	TH 16		578352 R	177,08	TH 20				578358 R	177,08		
	TH 20		578358 R	177,08	TH 20 S (PR-2B)**		Mini Z8		574788 R	124,51		
	TH 26		578362 R	177,08	TE-SA TE-SA press serie 800		TH 14			578348	177,08	
	TH 32		578364	177,08			TH 16			578352 R	177,08	
	TH 40		578624	234,69			TH 18			578356	177,08	
	TH 16 S (PR-2B)**	Mini Z8	574782 R	124,51			TH 20			578358 R	177,08	
	TH 20 S (PR-2B)**	Mini Z8	574788 R	124,51			TH 26			578362 R	177,08	
	TH 26 S (PR-2B)**	Mini Z8	574794 R	124,51			TH 32			578364	177,08	
	TH 32 S (PR-2B)	Mini Z8	574798 R	136,96			TH 40			578624	234,69	
	U 16		578374	165,66			TH 14 S (PR-2B)**		Mini Z8	574778 R	124,51	
U 20		578378	165,66	TH 16 S (PR-2B)**		Mini Z8	574782 R		124,51			
U 26 <sup>7)</sup>		578392	194,31	TH 18 S (PR-2B)**		Mini Z8	574786 R	124,51				
STELBI Stelgas	TH 16		578352 R	177,08		TH 20 S (PR-2B)**	Mini Z8	574788 R	124,51			
	TH 20		578358 R	177,08		TH 26 S (PR-2B)**	Mini Z8	574794 R	124,51			
	TH 26		578362 R	177,08		TH 32 S (PR-2B)	Mini Z8	574798 R	136,96			
	TH 16 S (PR-2B)**	Mini Z8	574782 R	124,51	THERMACOME ACOPEX ALU	H 16		578400	159,75			
	TH 20 S (PR-2B)**	Mini Z8	574788 R	124,51		H 20		578406	159,75			
	TH 26 S (PR-2B)**	Mini Z8	574794 R	124,51		H 26		578410	159,75			
	STH Westco COPPER PRESS	M 15		578312		146,98	H 32		578412	159,75		
M 22			578316	146,98		TH 16		578352 R	177,08			
M 28			578318	146,98		TH 20		578358 R	177,08			
M 35			578390	178,12		TH 26		578362 R	177,08			
M 15 S (PR-2B)		Mini Z8	574738 R	124,51	TH 32		578364	177,08				
M 22 S (PR-2B)		Mini Z8	574742 R	124,51	U 16		578374	165,66				
M 28 S (PR-2B)		Mini Z8	574744 R	124,51	U 20		578378	165,66				
M 35 S (PR-2B)	Mini Z8	574746 R	136,96	U 32		578382	194,31					
<b>T</b>												
TDM BRASS Serie 1600	H 16		578400	159,75	TIEMME 1650 AL-COBRAPEX	TH 14		578348	177,08			
	H 18		578404	159,75		TH 16		578352 R	177,08			
	H 20		578406	159,75		TH 18		578356	177,08			
	H 25		578408	159,75		TH 20		578358 R	177,08			
	H 26		578410	159,75		TH 25		578360	177,08			
	H 32		578412	159,75		TH 26		578362 R	177,08			
	TH 16		578352 R	177,08		THL 32		578368	177,08			
	TH 18		578356	177,08		TH 40		578624	234,69			
	TH 20		578358 R	177,08		TH 14 S (PR-2B)**	Mini Z8	574778 R	124,51			
	TH 25		578360	177,08		TH 16 S (PR-2B)**	Mini Z8	574782 R	124,51			
	TH 26		578362 R	177,08		TH 18 S (PR-2B)**	Mini Z8	574786 R	124,51			
	THL 32		578368	177,08		TH 20 S (PR-2B)**	Mini Z8	574788 R	124,51			
	TH 40		578624	234,69		TH 25 S (PR-2B)**	Mini Z8	574792 R	124,51			
	TH 16 S (PR-2B)**	Mini Z8	574782 R	124,51		TH 26 S (PR-2B)**	Mini Z8	574794 R	124,51			
	TH 18 S (PR-2B)**	Mini Z8	574786 R	124,51		TIEMME 1700 COBRAPEX	RFz 12		578490	184,45		
	TH 20 S (PR-2B)**	Mini Z8	574788 R	124,51			RFz 16		578492	184,45		
	TH 25 S (PR-2B)**	Mini Z8	574792 R	124,51			RFz 20		578494	184,45		
	TH 32 S (PR-2B)	Mini Z8	574798 R	136,96			RFz 25		578496	184,45		
	U 16		578374	165,66			RFz 32		578498	184,45		
	U 18		578376	165,66			TH 40		578624	234,69		
	U 20		578378	165,66								
	U 25		578380	165,66								
	U 32		578382	194,31								
	U 40		578386	236,66								

Pressfitting systems for gas installations must only be pressed with REMS pressing tongs Mini/pressing rings which are highlighted in yellow.

Observe the national regulations. Read and observe the instructions for use and the installation instructions of the system provider/manufacturer.

\*\* Can also be driven by the REMS Eco-Press manual radial press using the Z8 adapter tongs, see page 185. Observe the national regulations.

- 1) Only pressing tongs from designation "108" (1<sup>st</sup> quarter of 2008), "208" (2<sup>nd</sup> quarter of 2008) etc. can be used. The designation is stamped on every pressing jaw.
- 2) For taking suitable pressing inserts.
- 3) Only pressing tongs from designation "117" (1<sup>st</sup> quarter of 2017), "217" (2<sup>nd</sup> quarter of 2017) etc. can be used. The designation is stamped on every pressing jaw.
- 4) For pipes of the EN technical standard. Observe the instructions for use of the system provider/manufacturer.
- 5) For pipes of the ASTM technical standard. Observe the instructions for use of the system provider/manufacturer.
- 6) Only use Mini pressing tongs identified by "VMP ½" G" on the pressing jaws for gas installations.
- 7) Previous designation: Mini C 26 pressing tongs

The suitability of REMS pressing tools for pressfitting systems: Date 27.10.2023. For the updated situation regarding suitability status check our website: [www.rems.de](http://www.rems.de) > Downloads > Product catalogues, brochures > REMS Catalogue. See page 183 for adapter tongs. Pressing tongs for additional pressfitting systems on request.

# REMS pressing tongs Mini REMS pressing rings

## Accessories for REMS radial presses 22 kN

System	Pressing tongs Mini/ pressing rings	Driven by adapter tongs	Art.-No.	€
TIEMME 1650 AL-COBRAPEX GAS	TH 16		578352 R	177,08
	TH 20		578358 R	177,08
	TH 26		578362 R	177,08
	THL 32		578368	177,08
	TH 16 S (PR-2B)**	Mini Z8	574782 R	124,51
	TH 20 S (PR-2B)**	Mini Z8	574788 R	124,51
	TH 26 S (PR-2B)**	Mini Z8	574794 R	124,51
TIGRE ALPEX GAS	TH 16		578352 R	177,08
	TH 20		578358 R	177,08
	TH 26		578362 R	177,08
	TH 32		578364	177,08
TKM Systemtechnik	TH 14		578348	177,08
	TH 16		578352 R	177,08
	TH 20		578358 R	177,08
	TH 26		578362 R	177,08
	TH 32		578364	177,08
	TH 40		578624	234,69
TRA Multi TRA+	H 16		578400	159,75
	H 20		578406	159,75
	H 25		578408	159,75
	H 26		578410	159,75
	H 32		578412	159,75
	TH 16		578352 R	177,08
	TH 20		578358 R	177,08
	TH 25		578360	177,08
	TH 26		578362 R	177,08
	TH 32		578364	177,08
	TH 40		578624	234,69
	TH 16 S (PR-2B)**	Mini Z8	574782 R	124,51
	TH 20 S (PR-2B)**	Mini Z8	574788 R	124,51
	TH 25 S (PR-2B)**	Mini Z8	574792 R	124,51
	TH 26 S (PR-2B)**	Mini Z8	574794 R	124,51
	TH 32 S (PR-2B)	Mini Z8	574798 R	136,96
	U 16		578374	165,66
U 20		578378	165,66	
U 25		578380	165,66	
U 26 <sup>7)</sup>		578392	194,31	
U 32		578382	194,31	
U 40		578386	236,66	
TRA MULTITRAPRESS	U 16		578374	165,66
	U 18		578376	165,66
	U 20		578378	165,66
	U 25		578380	165,66
	U 32		578382	194,31
	U 40		578386	236,66
TRA TRAPRESS	H 12		578396	159,75
	H 16		578400	159,75
	H 20		578406	159,75
	H 25		578408	159,75
	H 32		578412	159,75
	Rfz 12		578490	184,45
	Rfz 16		578492	184,45
	Rfz 20		578494	184,45
	Rfz 25		578496	184,45
	Rfz 32		578498	184,45
Tradelink TradePex Crimp Water	K16/P18		578592	184,45
	K/20		578594	184,45
	K/25		578596	184,45
	K32		578598	184,45
	K1/40		578600	184,45
Tradelink TradePex Crimp Gas	K16/P18		578592	184,45
	K/20		578594	184,45
	K/25		578596	184,45
	K32		578598	184,45
	K1/40		578600	184,45
TUBIPLAST ITALY MULTILAYER PIPE	H 16		578400	159,75
	H 18		578404	159,75
	H 20		578406	159,75
	H 26		578410	159,75
	H 32		578412	159,75
	TH 16		578352 R	177,08
	TH 18		578356	177,08
	TH 20		578358 R	177,08
	TH 26		578362 R	177,08
	TH 32		578364	177,08
	TH 40		578624	234,69
	TH 16 S (PR-2B)**	Mini Z8	574782 R	124,51
	TH 18 S (PR-2B)**	Mini Z8	574786 R	124,51
	TH 20 S (PR-2B)**	Mini Z8	574788 R	124,51
	TH 26 S (PR-2B)**	Mini Z8	574794 R	124,51
	TH 32 S (PR-2B)	Mini Z8	574798 R	136,96
	U 16		578374	165,66
	U 18		578376	165,66
	U 20		578378	165,66
	U 26 <sup>7)</sup>		578392	194,31
	U 32		578382	194,31
TUBIPLAST ITALY MULTILAYER PIPE GAS SYSTEM	TH 16		578352 R	177,08
	TH 18		578356	177,08
	TH 20		578358 R	177,08
	TH 26		578362 R	177,08
	TH 32		578364	177,08
	TH 16 S (PR-2B)**	Mini Z8	574782 R	124,51
	TH 18 S (PR-2B)**	Mini Z8	574786 R	124,51
	TH 20 S (PR-2B)**	Mini Z8	574788 R	124,51
	TH 26 S (PR-2B)**	Mini Z8	574794 R	124,51
	TH 32 S (PR-2B)	Mini Z8	574798 R	136,96

System	Pressing tongs Mini/ pressing rings	Driven by adapter tongs	Art.-No.	€
TWEETOP	U 16		578374	165,66
	U 20		578378	165,66
	U 25		578380	165,66
	U 32		578382	194,31
	U 40		578386	236,66
<b>U</b>				
UNICAL AG MAX-MULTIPEX	U 16		578374	165,66
	U 20		578378	165,66
	H 26		578410	159,75
	U 26 <sup>7)</sup>		578392	194,31
	U 32		578382	194,31
UNIDELTA DELTAPRESS	TH 16		578352 R	177,08
	TH 20		578358 R	177,08
	TH 26		578362 R	177,08
	TH 32		578364	177,08
	TH 40		578624	234,69
	TH 16 S (PR-2B)**	Mini Z8	574782 R	124,51
	TH 20 S (PR-2B)**	Mini Z8	574788 R	124,51
	TH 26 S (PR-2B)**	Mini Z8	574794 R	124,51
	TH 32 S (PR-2B)	Mini Z8	574798 R	136,96
UNIDELTA DELTAPRESS GAS	H 16		578400	159,75
	H 20		578406	159,75
	H 26		578410	159,75
	H 32		578412	159,75
	U 16		578374	165,66
	U 20		578378	165,66
	U 32		578382	194,31
	U 40		578386	236,66
	TH 16		578352 R	177,08
	TH 20		578358 R	177,08
	TH 26		578362 R	177,08
	TH 32		578364	177,08
	TH 16 S (PR-2B)**	Mini Z8	574782 R	124,51
	TH 20 S (PR-2B)**	Mini Z8	574788 R	124,51
	TH 26 S (PR-2B)**	Mini Z8	574794 R	124,51
TH 32 S (PR-2B)	Mini Z8	574798 R	136,96	
Uponor	UP 14		578576	165,66
	UP 16		578578	165,66
	UP 20		578582	165,66
	UP 25		578584	165,66
	UP 32		578586	194,31
	U 40		578386	236,66
<b>V</b>				
Valsir Bravopress	B 16		578468	193,28
	B 20		578472	193,28
	B 26		578474	213,00
	B 32		578476	213,00
	F 16		578456	168,68
	F 20		578460	168,68
	F 26		578462	182,48
	F 16 S (PR-2B)**	Mini Z8	574728 R	124,51
	F 20 S (PR-2B)**	Mini Z8	574730 R	124,51
	F 26 S (PR-2B)**	Mini Z8	574732 R	124,51
	H 16		578400	159,75
	H 20		578406	159,75
	H 26		578410	159,75
	H 32		578412	159,75
	H 32 V		578602	204,17
TH 16		578352 R	177,08	
TH 20		578358 R	177,08	
TH 26		578362 R	177,08	
TH 32		578364	177,08	
U 16		578374	165,66	
U 20		578378	165,66	
U 26 <sup>7)</sup>		578392	194,31	
U 32		578382	194,31	
Valsir PEXAL	H 14		578398	159,75
	H 16		578400	159,75
	H 20		578406	159,75
	H 26		578410	159,75
	H 32		578412	159,75
	H 32 V		578602	204,17
	TH 16		578352 R	177,08
	TH 20		578358 R	177,08
	TH 26		578362 R	177,08
	TH 32		578364	177,08
U 16		578374	165,66	
U 20		578378	165,66	
U 26 <sup>7)</sup>		578392	194,31	
U 32		578382	194,31	

# REMS pressing tongs Mini REMS pressing rings

## Accessories for REMS radial presses 22 kN

System	Pressing tongs Mini / pressing rings	Driven by adapter tongs	Art.-No.	€	System	Pressing tongs Mini / pressing rings	Driven by adapter tongs	Art.-No.	€	
Van Marcke NV SYSTEMPEX	TH 16		578352 R	177,08	Viega MegaPress 316 (ASTM) <sup>51</sup>	VMP ½" G (OD 21,3 mm)		578666 R	204,17	
	TH 20		578358 R	177,08		VMPz ¾" (OD 26,9 mm)		578664	204,17	
	TH 26		578362 R	177,08		Viega MegaPress 316 FKM	VMP ½" G (OD 21,3 mm)		578666 R	204,17
	TH 32		578364	177,08		VMPz ¾" (OD 26,9 mm)		578664	204,17	
	TH 40		578624	234,69		(ASTM) <sup>51</sup>	VMP ½" G (OD 21,3 mm)		578666 R	204,17
	TH 16 S (PR-2B)**	Mini Z8	574782 R	124,51		VMPz ¾" (OD 26,9 mm)		578664	204,17	
	TH 20 S (PR-2B)**	Mini Z8	574788 R	124,51		Viega MegaPress CuNi (ASTM) <sup>51</sup>	VMP ½" G (OD 21,3 mm)		578666 R	204,17
	TH 26 S (PR-2B)**	Mini Z8	574794 R	124,51		VMPz ¾" (OD 26,9 mm)		578664	204,17	
Van Marcke NV Tubipress	TH 32 S (PR-2B)	Mini Z8	574798 R	136,96	Viega MegaPress FKM (ASTM) <sup>51</sup>	VMP ½" G (OD 21,3 mm)		578666 R	204,17	
	M 12		578310	146,98	VMPz ¾" (OD 26,9 mm)		578664	204,17		
	M 15		578312	146,98	Viega MegaPresG (ASTM) <sup>51</sup>	VMP ½" G (OD 21,3 mm)		578666 R	204,17	
	M 18		578314	146,98	VMPz ¾" (OD 26,9 mm)		578664	204,17		
	M 22		578316	146,98	Viega Megapress (EN) <sup>41</sup>	VMP ¾" (OD 17,2 mm)		578660	204,17	
	M 28		578318	146,98	VMP ½" G (OD 21,3 mm)		578666 R	204,17		
	M 35		578390	178,12	VMPz ¾" (OD 26,9 mm)		578664	204,17		
	M 12 S (PR-2B)	Mini Z8	574736 R	124,51	Viega MegapressS (EN) <sup>41</sup>	VMP ¾" (OD 17,2 mm)		578660	204,17	
	M 15 S (PR-2B)	Mini Z8	574738 R	124,51	VMP ½" G (OD 21,3 mm)		578666 R	204,17		
	M 18 S (PR-2B)	Mini Z8	574740 R	124,51	VMPz ¾" (OD 26,9 mm)		578664	204,17		
	M 22 S (PR-2B)	Mini Z8	574742 R	124,51	Viega Pexfit	VX 16		578552	204,17	
	M 28 S (PR-2B)	Mini Z8	574744 R	124,51	VX 20		578554	204,17		
	M 35 S (PR-2B)	Mini Z8	574746 R	136,96	VX 25		578556	204,17		
	Variotherm System TH	TH 11,6		578344	177,08	Viega Pexfit G	VX 16		578552	204,17
TH 16			578352 R	177,08	VX 20		578554	204,17		
TH 20			578358 R	177,08	VX 25		578556	204,17		
TH 16 S (PR-2B)**		Mini Z8	574782 R	124,51	Viega Prestabo	V 12		578324	146,98	
TH 20 S (PR-2B)**		Mini Z8	574788 R	124,51	V 15		578328	146,98		
VESBO CARBON	M 15		578312	146,98	V 18		578332	146,98		
	M 18		578314	146,98	V 22		578334	146,98		
	M 22		578316	146,98	V 28		578336	146,98		
	M 28		578318	146,98	V 12 S (PR-2B)	Mini Z8	574748 R	124,51		
	M 35		578390	178,12	V 14 S (PR-2B)	Mini Z8	574750 R	124,51		
	M 15 S (PR-2B)	Mini Z8	574738 R	124,51	V 15 S (PR-2B)	Mini Z8	574752 R	124,51		
	M 18 S (PR-2B)	Mini Z8	574740 R	124,51	V 16 S (PR-2B)	Mini Z8	574754 R	124,51		
	M 22 S (PR-2B)	Mini Z8	574742 R	124,51	V 18 S (PR-2B)	Mini Z8	574756 R	124,51		
	M 28 S (PR-2B)	Mini Z8	574744 R	124,51	V 22 S (PR-2B)	Mini Z8	574758 R	124,51		
	M 35 S (PR-2B)	Mini Z8	574746 R	136,96	V 28 S (PR-2B)	Mini Z8	574760 R	124,51		
VESBO INOX	M 15		578312	146,98	V 35 S (PR-2B)	Mini Z8	574762 R	136,96		
	M 18		578314	146,98	Viega Profipress	V 12		578324	146,98	
	M 22		578316	146,98	VG 14		578338	146,98		
	M 28		578318	146,98	V 15		578328	146,98		
	M 35		578390	178,12	V 16		578340	146,98		
	M 15 S (PR-2B)	Mini Z8	574738 R	124,51	V 18		578332	146,98		
	M 18 S (PR-2B)	Mini Z8	574740 R	124,51	V 22		578334	146,98		
	M 22 S (PR-2B)	Mini Z8	574742 R	124,51	V 28		578336	146,98		
	M 28 S (PR-2B)	Mini Z8	574744 R	124,51	V 35		578604	178,12		
	M 35 S (PR-2B)	Mini Z8	574746 R	136,96	V 12 S (PR-2B)	Mini Z8	574748 R	124,51		
	VESBO MULTIPRESS TH-U	TH 16		578352 R	177,08	VG 14 S (PR-2B)	Mini Z8	574750 R	124,51	
		TH 20		578358 R	177,08	V 15 S (PR-2B)	Mini Z8	574752 R	124,51	
		TH 26		578362 R	177,08	VG 16 S (PR-2B)	Mini Z8	574754 R	124,51	
TH 32			578364	177,08	V 18 S (PR-2B)	Mini Z8	574756 R	124,51		
TH 16 S (PR-2B)**		Mini Z8	574782 R	124,51	V 22 S (PR-2B)	Mini Z8	574758 R	124,51		
TH 20 S (PR-2B)**		Mini Z8	574788 R	124,51	V 28 S (PR-2B)	Mini Z8	574760 R	124,51		
TH 26 S (PR-2B)**		Mini Z8	574794 R	124,51	V 35 S (PR-2B)	Mini Z8	574762 R	136,96		
TH 32 S (PR-2B)		Mini Z8	574798 R	136,96	Viega Profipress G	V 12		578324	146,98	
U 16			578374	165,66	VG 14		578338	146,98		
U 20			578378	165,66	V 15		578328	146,98		
U 26 <sup>7)</sup>			578392	194,31	VG 16		578340	146,98		
U 32			578382	194,31	V 18		578332	146,98		
VESBO VPREMIUM		U 16		578374	165,66	V 22		578334	146,98	
	U 20		578378	165,66	V 28		578336	146,98		
	U 25		578380	165,66	V 35		578604	178,12		
	U 32		578382	194,31	V 12 S (PR-2B)	Mini Z8	574748 R	124,51		
	U 40		578386	236,66	VG 14 S (PR-2B)	Mini Z8	574750 R	124,51		
Viega Fonterra	YX 12		578550	204,17	V 15 S (PR-2B)	Mini Z8	574752 R	124,51		
	VP 14/15		578480	176,56	V 16 S (PR-2B)	Mini Z8	574754 R	124,51		
	VP 16/17		578482	176,56	V 18 S (PR-2B)	Mini Z8	574756 R	124,51		
	VP 20		578484	176,56	V 22 S (PR-2B)	Mini Z8	574758 R	124,51		
	VP 25		578486	176,56	V 28 S (PR-2B)	Mini Z8	574760 R	124,51		
Viega MegaPress (ASTM) <sup>51</sup>	VMP ½" G (OD 21,3 mm)		578666 R	204,17	V 35 S (PR-2B)	Mini Z8	574762 R	136,96		
	VMPz ¾" (OD 26,9 mm)		578664	204,17	Viega Profipress S	V 12		578324	146,98	
Viega MegaPress 304 FKM (ASTM) <sup>51</sup>	VMP ½" G (OD 21,3 mm)		578666 R	204,17	V 15		578328	146,98		
	VMPz ¾" (OD 26,9 mm)		578664	204,17	V 18		578332	146,98		

Pressfitting systems for gas installations must only be pressed with REMS pressing tongs Mini/pressing rings which are highlighted in yellow.

Observe the national regulations. Read and observe the instructions for use and the installation instructions of the system provider/manufacturer.

\*\* Can also be driven by the REMS Eco-Press manual radial press using the Z8 adapter tongs, see page 185. Observe the national regulations.

<sup>1)</sup> Only pressing tongs from designation "108" (1<sup>st</sup> quarter of 2008), "208" (2<sup>nd</sup> quarter of 2008) etc. can be used. The designation is stamped on every pressing jaw.

<sup>2)</sup> For taking suitable pressing inserts.

<sup>3)</sup> Only pressing tongs from designation "117" (1<sup>st</sup> quarter of 2017), "217" (2<sup>nd</sup> quarter of 2017) etc. can be used. The designation is stamped on every pressing jaw.

<sup>4)</sup> For pipes of the EN technical standard. Observe the instructions for use of the system provider/manufacturer.

<sup>5)</sup> For pipes of the ASTM technical standard. Observe the instructions for use of the system provider/manufacturer.

<sup>6)</sup> Only use Mini pressing tongs identified by "VMP ½" G" on the pressing jaws for gas installations.

<sup>7)</sup> Previous designation: Mini C 26 pressing tongs

The suitability of REMS pressing tools for pressfitting systems: Date 27.10.2023. For the updated situation regarding suitability status check our website:

[www.rems.de](http://www.rems.de) > Downloads > Product catalogues, brochures > REMS Catalogue.

See page 183 for adapter tongs. Pressing tongs for additional pressfitting systems on request.

# REMS pressing tongs Mini REMS pressing rings

## Accessories for REMS radial presses 22 kN

System	Pressing tongs Mini / pressing rings	Driven by adapter tongs	Art.-No.	€	
Viega Profipress Therm	V 12		578324	146,98	
	V 15		578328	146,98	
	V 18		578332	146,98	
	V 22		578334	146,98	
	V 12 S (PR-2B)	Mini Z8	574748 R	124,51	
	V 15 S (PR-2B)	Mini Z8	574752 R	124,51	
Viega ProPress (ASTM) <sup>5)</sup>	V 18 S (PR-2B)	Mini Z8	574756 R	124,51	
	V 22 S (PR-2B)	Mini Z8	574758 R	124,51	
	VUS ½" (OD 15,9 mm)		578566	177,50	
	VUS ¾" (OD 22,2 mm)		578568	177,50	
	VUS 1" (OD 28,6 mm)		578570	177,50	
	VUS 1¼" (OD 34,9 mm)		578606	177,50	
Viega ProPress 304 FKM (ASTM) <sup>5)</sup>	VUS ½" S (PR-2B) (OD 15,9 mm)	Mini Z8	574764 R	124,51	
	VUS ¾" S (PR-2B) (OD 22,2 mm)	Mini Z8	574766 R	124,51	
	VUS 1" S (PR-2B) (OD 28,6 mm)	Mini Z8	574768 R	124,51	
	VUS 1¼" S (PR-2B) (OD 34,9 mm)	Mini Z8	574770 R	124,51	
	VUS ½" (OD 15,9 mm)		578566	177,50	
	VUS ¾" (OD 22,2 mm)		578568	177,50	
Viega ProPress 316 (ASTM) <sup>5)</sup>	VUS 1" (OD 28,6 mm)		578570	177,50	
	VUS 1¼" (OD 34,9 mm)		578606	177,50	
	VUA 15 (OD 12,7 mm)		578630	151,86	
	VUA 20 (OD 19,1 mm)		578632	151,86	
	VUA 25 (OD 25,4 mm)		578634	151,86	
	VUA 32 (OD 31,8 mm)		578636	159,75	
Viega Propress WATER System AUS	VUA 15 S (PR-2B) (OD 12,7 mm)	Mini Z8	574804 R	124,51	
	VUA 20 S (PR-2B)** (OD 19,1 mm)	Mini Z8	574806 R	124,51	
	VUA 25 S (PR-2B)** (OD 25,4 mm)	Mini Z8	574808 R	136,96	
	VUA 32 S (PR-2B) (OD 31,8 mm)	Mini Z8	574856 R	136,96	
	VUA 15 (OD 12,7 mm)		578630	151,86	
	VUA 20 (OD 19,1 mm)		578632	151,86	
Viega PropressGAS System AUS	VUA 25 (OD 25,4 mm)		578634	151,86	
	VUA 32 (OD 31,8 mm)		578636	159,75	
	VRX 16		578640	186,42	
	VRX 20		578642	186,42	
Viega Raxofix	VRX 16		578640	186,42	
	VRX 20		578642	186,42	
	VRX 25		578644	204,17	
	VRX 32		578646	204,17	
Viega Sanfix	VP 16/17		578482	176,56	
	VP 20		578484	176,56	
	VP 25		578486	176,56	
	VP 32		578488	195,25	
Viega Sanfix Fosta	VP 16/17		578482	176,56	
	VP 20		578484	176,56	
	VP 25		578486	176,56	
	VP 32		578488	195,25	
Viega Sanpress	V 12		578324	146,98	
	V 15		578328	146,98	
	V 18		578332	146,98	
	V 22		578334	146,98	
	V 28		578336	146,98	
	V 35		578604	178,12	
	V 12 S (PR-2B)	Mini Z8	574748 R	124,51	
	V 15 S (PR-2B)	Mini Z8	574752 R	124,51	
	V 18 S (PR-2B)	Mini Z8	574756 R	124,51	
	V 22 S (PR-2B)	Mini Z8	574758 R	124,51	
	V 28 S (PR-2B)	Mini Z8	574760 R	124,51	
	V 35 S (PR-2B)	Mini Z8	574762 R	136,96	
	Viega Sanpress Inox	V 15		578328	146,98
		V 18		578332	146,98
		V 22		578334	146,98
V 28			578336	146,98	
V 35			578604	178,12	
V 15 S (PR-2B)		Mini Z8	574752 R	124,51	
V 18 S (PR-2B)		Mini Z8	574756 R	124,51	
V 22 S (PR-2B)		Mini Z8	574758 R	124,51	
V 28 S (PR-2B)		Mini Z8	574760 R	124,51	
V 35 S (PR-2B)		Mini Z8	574762 R	136,96	
Viega Sanpress Inox G		V 15		578328	146,98
		V 18		578332	146,98
		V 22		578334	146,98
		V 28		578336	146,98
		V 35		578604	178,12
	V 15 S (PR-2B)	Mini Z8	574752 R	124,51	
	V 18 S (PR-2B)	Mini Z8	574756 R	124,51	
	V 22 S (PR-2B)	Mini Z8	574758 R	124,51	
	V 28 S (PR-2B)	Mini Z8	574760 R	124,51	
	V 35 S (PR-2B)	Mini Z8	574762 R	136,96	
Viega Smartpress	VX 16		578552	204,17	
	VX 20		578554	204,17	
	VX 25		578556	204,17	
Viega Temponox	V 15		578328	146,98	
	V 18		578332	146,98	
	V 22		578334	146,98	
	V 28		578336	146,98	
	V 35		578604	178,12	
	V 15 S (PR-2B)	Mini Z8	574752 R	124,51	
	V 18 S (PR-2B)	Mini Z8	574756 R	124,51	
	V 22 S (PR-2B)	Mini Z8	574758 R	124,51	
	V 28 S (PR-2B)	Mini Z8	574760 R	124,51	

System	Pressing tongs Mini / pressing rings	Driven by adapter tongs	Art.-No.	€
Viessmann	TH 14		578348	177,08
	TH 16		578352 R	177,08
	TH 20		578358 R	177,08
	TH 26		578362 R	177,08
	TH 32		578364	177,08
	Vogel & Noot EASYTEC	TH 16		578352 R
TH 20			578358 R	177,08
TH 26			578362 R	177,08
TH 32			578364	177,08
TH 40			578624	234,69
TH 16 S (PR-2B)**		Mini Z8	574782 R	124,51
VSH	TH 20 S (PR-2B)**	Mini Z8	574788 R	124,51
	TH 26 S (PR-2B)**	Mini Z8	574794 R	124,51
	TH 32 S (PR-2B)	Mini Z8	574798 R	136,96

VSH > Aalberts integrated piping systems

## W

Watts MTR Art press	TH 16		578352 R	177,08
	TH 20		578358 R	177,08
	TH 26		578362 R	177,08
	TH 32		578364	177,08
WATTS RADIANT	US ¾"		578534	201,16
	US ½"		578536	201,16
	US ¾"		578538	201,16
Watts WaterPEX	US 1"		578540	201,16
	US ¾"		578534	201,16
WATTS RADIANT	US ½"		578536	201,16
	US ¾"		578538	201,16
Watts RadiantPEX	US 1"		578540	201,16
	U 16 (½")		578374	165,66
WATTS RADIANT	U 20 (¾")		578378	165,66
	U 25 (¾")		578380	165,66
RadiantPEX-AL	U 32 (1")		578382	194,31
	B 16		578468	193,28
Wavin Tigris K5/M5	B 20		578472	193,28
	B 32		578476	213,00
	H 16		578400	159,75
	H 20		578406	159,75
	H 25		578408	159,75
	H 32		578412	159,75
	TH 16		578352 R	177,08
	TH 20		578358 R	177,08
	TH 25		578364	177,08
	TH 32		578624	234,69
	TH 16 S (PR-2B)**	Mini Z8	574782 R	124,51
	TH 20 S (PR-2B)**	Mini Z8	574788 R	124,51
TH 25 S (PR-2B)**	Mini Z8	574792 R	124,51	
TH 32 S (PR-2B)	Mini Z8	574798 R	136,96	
WEECON PRESS-C-Stahl	U 16		578374	165,66
	U 20		578378	165,66
	U 25		578380	165,66
	U 32		578382	194,31
	U 40		578386	236,66
	UP 16		578578	165,66
	UP 20		578582	165,66
	UP 25		578584	165,66
	UP 32		578586	194,31
	M 15		578312	146,98
	M 18		578314	146,98
	M 22		578316	146,98
M 28		578318	146,98	
M 35		578390	178,12	
M 15 S (PR-2B)	Mini Z8	574738 R	124,51	
M 18 S (PR-2B)	Mini Z8	574740 R	124,51	
M 22 S (PR-2B)	Mini Z8	574742 R	124,51	
M 28 S (PR-2B)	Mini Z8	574744 R	124,51	
M 35 S (PR-2B)	Mini Z8	574746 R	136,96	
WEECON PRESS-Edelstahl	M 15		578312	146,98
	M 18		578314	146,98
	M 22		578316	146,98
	M 28		578318	146,98
	M 35		578390	178,12
	M 15 S (PR-2B)	Mini Z8	574738 R	124,51
WEECON PRESS-Kupfer	M 18 S (PR-2B)	Mini Z8	574740 R	124,51
	M 22 S (PR-2B)	Mini Z8	574742 R	124,51
	M 28 S (PR-2B)	Mini Z8	574744 R	124,51
	M 35 S (PR-2B)	Mini Z8	574746 R	136,96
	V 15		578328	146,98
	V 18		578332	146,98
WEECON PRESS-Kupfer	V 22		578334	146,98
	V 28		578336	146,98
	V 35		578604	178,12
	V 15 S (PR-2B)	Mini Z8	574752 R	124,51
	V 18 S (PR-2B)	Mini Z8	574756 R	124,51
	V 22 S (PR-2B)	Mini Z8	574758 R	124,51
	V 28 S (PR-2B)	Mini Z8	574760 R	124,51
	V 35 S (PR-2B)	Mini Z8	574762 R	136,96

# REMS pressing tongs Mini

## REMS pressing rings

### Accessories for REMS radial presses 22 kN

System	Pressing tongs Mini / pressing rings	Driven by adapter tongs	Art.-No.	€
WEM	U 16		578374	165,66
WIELAND-WERKE cuprotherm CTX	TH 14		578348	177,08
	TH 16		578352 R	177,08
	TH 14 S (PR-2B)**	Mini Z8	574778 R	124,51
	TH 16 S (PR-2B)**	Mini Z8	574782 R	124,51
WKS-Press	TH 14		578348	177,08
	TH 16		578352 R	177,08
	TH 17		578354	177,08
	TH 20		578358 R	177,08
	TH 26		578362 R	177,08
	TH 32		578364	177,08
	TH 40		578624	234,69
	WÜRTH	TH 16		578352 R
Würth	TH 20		578358 R	177,08
	TH 26		578362 R	177,08
	HE 32		578370 R	212,06

### X

XtraConnect	F 16		578456	168,68	
	F 20		578460	168,68	
	F 26		578462	182,48	
	F 32		578464	182,48	
	F 16 S (PR-2B)**	Mini Z8	574728 R	124,51	
	F 20 S (PR-2B)**	Mini Z8	574730 R	124,51	
	F 26 S (PR-2B)**	Mini Z8	574732 R	124,51	
	F 32 S (PR-2B)	Mini Z8	574734 R	136,96	
	H 16		578400	159,75	
	H 20		578406	159,75	
	H 26		578410	159,75	
	H 32		578412	159,75	
	TH 16		578352 R	177,08	
	TH 20		578358 R	177,08	
	TH 26		578362 R	177,08	
	TH 32		578364	177,08	
	TH 16 S (PR-2B)**	Mini Z8	574782 R	124,51	
	TH 20 S (PR-2B)**	Mini Z8	574788 R	124,51	
	TH 26 S (PR-2B)**	Mini Z8	574794 R	124,51	
	TH 32 S (PR-2B)	Mini Z8	574798 R	136,96	
	U 16		578374	165,66	
	U 20		578378	165,66	
	(DN 26)	U 25		578380	165,66
		U 32		578382	194,31
		VP 16		578482	176,56
		VP 20		578484	176,56
		VP 32		578488	195,25

### Y

YX COPPER	Yz 16 UNI		578740	184,45
UNIPEX Water & Gas	Yz 20 UNI		578742	184,45
(AUS)	Yz 25 UNI		578744	184,45
	Yz 32 UNI		578746	184,45

System	Pressing tongs Mini / pressing rings	Driven by adapter tongs	Art.-No.	€
<b>Z</b>				
ZEWOTHERM	TH 12		578346	177,08
Zewo Press Premium	TH 16		578352 R	177,08
	TH 17		578354	177,08
	TH 18		578356	177,08
	TH 20		578358 R	177,08
	TH 26		578362 R	177,08
	TH 32		578364	177,08
	TH 40		578624	234,69
	TH 12 S (PR-2B)**	Mini Z8	574776 R	124,51
	TH 16 S (PR-2B)**		574782 R	124,51
	TH 17 S (PR-2B)**	Mini Z8	574784 R	124,51
	TH 18 S (PR-2B)**	Mini Z8	574786 R	124,51
	TH 20 S (PR-2B)**		574788 R	124,51
	TH 26 S (PR-2B)**		574794 R	124,51
TH 32 S (PR-2B)		574798 R	136,96	
ZEWOTHERM	TH 16		578352 R	177,08
Zewo Press PPSU	TH 20		578358 R	177,08
	TH 26		578362 R	177,08
	TH 32		578364	177,08
	TH 16 S (PR-2B)**	Mini Z8	574782 R	124,51
	TH 20 S (PR-2B)**	Mini Z8	574788 R	124,51
	TH 26 S (PR-2B)**	Mini Z8	574794 R	124,51
	TH 32 S (PR-2B)	Mini Z8	574798 R	136,96
ZURN	US ¾"		578534	201,16
INDUSTRIES	US ½"		578536	201,16
ZURN PEX	US ¾"		578538	201,16
	US 1"		578540	201,16

Pressfitting systems for gas installations must only be pressed with REMS pressing tongs Mini/pressing rings which are highlighted in yellow.

Observe the national regulations. Read and observe the instructions for use and the installation instructions of the system provider/manufacturer.

\*\* Can also be driven by the REMS Eco-Press manual radial press using the Z8 adapter tongs, see page 185. Observe the national regulations.

- 1) Only pressing tongs from designation "108" (1<sup>st</sup> quarter of 2008), "208" (2<sup>nd</sup> quarter of 2008) etc. can be used. The designation is stamped on every pressing jaw.
- 2) For taking suitable pressing inserts.
- 3) Only pressing tongs from designation "117" (1<sup>st</sup> quarter of 2017), "217" (2<sup>nd</sup> quarter of 2017) etc. can be used. The designation is stamped on every pressing jaw.
- 4) For pipes of the EN technical standard. Observe the instructions for use of the system provider/manufacturer.
- 5) For pipes of the ASTM technical standard. Observe the instructions for use of the system provider/manufacturer.
- 6) Only use Mini pressing tongs identified by "VMP ½" G" on the pressing jaws for gas installations.
- 7) Previous designation: Mini C 26 pressing tongs

The suitability of REMS pressing tools for pressfitting systems: Date 27.10.2023. For the updated situation regarding suitability status check our website: [www.rems.de](http://www.rems.de) > Downloads > Product catalogues, brochures > REMS Catalogue.

See page 183 for adapter tongs. Pressing tongs for additional pressfitting systems on request.

### Accessories

Description	Art.-No.	€
<b>Adapter tongs Mini Z8</b> for driving REMS pressing rings S (PR-2B)	574700R	<b>144,28</b>
<b>Steel case</b> with insert for adapter tongs Mini Z8 and adapter tongs Z8 as well as 6 REMS pressing rings S (PR-2B)	574516R	<b>96,53</b>
<b>L-Boxx system case</b> with inlay for Mini Z8 adapter tongs and Z8 adapter tongs as well as 14 REMS S pressing rings (PR-2B)	574704R	<b>146,36</b>
<b>Steel case</b> with insert for 8 pressing tongs Mini/ cropping tongs Mini and compartment for pipe cutter up to 42 mm	578295R	<b>96,53</b>
<b>L-Boxx system case</b> with insert for 11 pressing tongs Mini and 6 pressing rings S (PR-2B)	578659R	<b>146,36</b>



# REMS cropping tongs Mini

Accessories for REMS radial presses 22 kN

High performance cropping tongs Mini in forged and specially hardened steel for cutting threaded rods.

Steel, stainless steel up to hardness classification 4.8 (400 N/mm<sup>2</sup>) M 6 – M 10

## REMS cropping tongs Mini – cuts in just 2 seconds!

Made of forged and specially hardened steel.

Reversible cropping inserts for double service life.

M cropping inserts with high precision thread contour machined on CNC machining centres for exact guiding of the threaded rod in the cutting process. Pliers parts, cropping inserts and specially machined and hardened cutting edges, made to fit exactly, for cutting without burr.

Threaded rod can be screwed into a threaded connection of the pipe clip or the nut without rework after cutting.

Cutting device in pliers design (**Patent EP 1 459 825, patent US 7,284,330**). Very compact design and low weight of the REMS Mini cropping tongs due to special arrangement of the cropping tongs connection (**Patent EP 1 952 948**). Recesses in the connecting plate for safe guidance of the connecting lugs for offset-free pressing (**Patent EP 2 347 862**).

Can be driven by all REMS radial presses 22 kN.

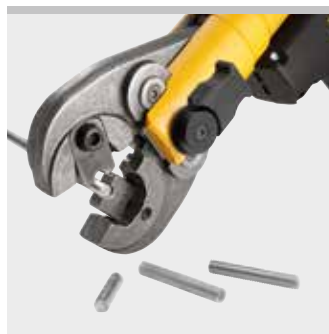

German Quality Product

## Supply format

**REMS cropping tongs Mini.** Cropping tongs with 1 pair of reversible cropping inserts for steel, stainless steel, M 6 – M 10. In a carton.

Description	for threaded rods	Art.-No.	€
<b>REMS cropping tongs Mini M 6</b>	M 6	578620	<b>241,85</b>
<b>REMS cropping tongs Mini M 8</b>	M 8	578621	<b>241,85</b>
<b>REMS cropping tongs Mini M 10</b>	M 10	578622	<b>241,85</b>



Patent EP 1 952 948  
Patent EP 1 459 825  
Patent US 7,284,330  
Patent EP 2 347 862

## Accessories

Description	for threaded rods	Art.-No.	€
<b>Cropping inserts M 6 (pair)</b>	M 6	571891	<b>111,07</b>
<b>Cropping inserts M 8 (pair)</b>	M 8	571896	<b>111,07</b>
<b>Cropping inserts M 10 (pair)</b>	M 10	571866	<b>111,07</b>
<b>Steel case with insert for 8 pressing tongs Mini/cropping tongs Mini and compartment for pipe cutter up to 42 mm</b>		578295R	<b>96,53</b>





Universal, manual radial press for producing pipe pressing joints for common pressfitting systems.

Pressing joints with plastic and multi-layer composite tubes  $\varnothing$  10–26 mm  
 $\varnothing$   $\frac{3}{8}$ –1"

Complete range of REMS pressing tongs/pressing rings for all common pressfitting systems, see page 198–238.

### REMS Eco-Press – universal up to $\varnothing$ 26 mm. Secure crimping in seconds.

#### System advantage

Only **one** type of pressing tongs/pressing rings for all REMS radial presses 32 kN and suitable radial presses of other makes with 32 kN thrust force.

All pressing tongs marked with \* have another connection and also fit the manual radial press REMS Eco-Press. All pressing rings S (PR-2B) marked with \*\* can also be driven with the manual radial press REMS Eco-Press using the adapter tong Z8.

#### Pressing tongs/pressing rings for all common systems

Complete assortment of REMS pressing tongs/pressing rings for all common pressfitting systems (page 198–238). Highly durable pressing tongs/pressing rings made of tenacious, specially hardened special steel. Pressing contours of REMS pressing tongs/pressing rings are system-specific and correspond to the respective pressfitting system. Thus perfect system conformity, safe press jointing. For driving the REMS pressing rings S (PR-2B) adapter tongs Z8 are required, see page 238.

#### Design

Compact, handy, light. Drive unit with short tubular arms only 1.6 kg. Works anywhere, free-hand, overhead, in confined areas. Secure seating of pressing tongs through locking pins. Dividable tubular arms for individual adjustment of leverage to accommodate different force demands of different pressfitting systems.

#### Pressing operation

A perfect joint is achieved when pressing tongs close completely. Final-lock-positioning, the pressing jaws remain in a closed position until opening. This way, the perfect pressing joint (completely closed pressing jaws) can be observed.

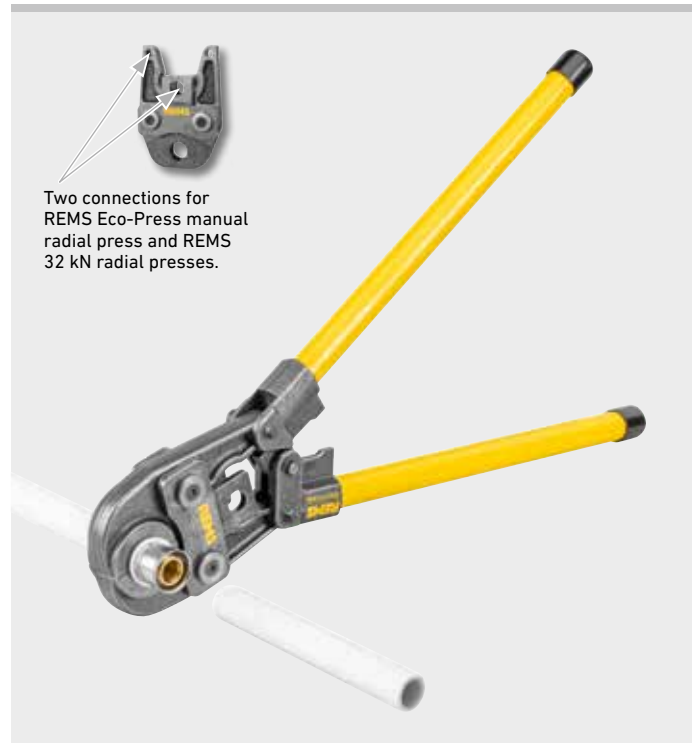

Two connections for REMS Eco-Press manual radial press and REMS 32 kN radial presses.

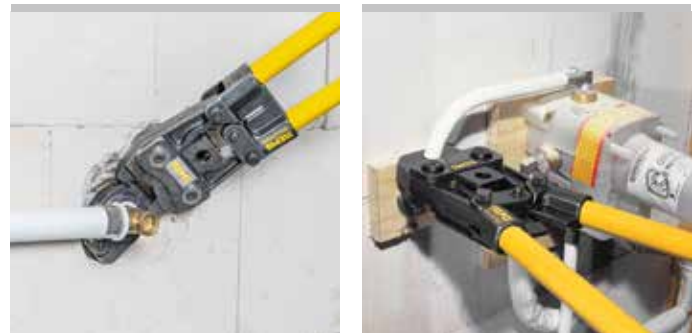

German Quality Product



Info

### Supply format

**REMS Eco-Press drive unit.** Manual radial press with final-lock-positioning for producing pressing joints of plastic and multi-layer composite tubes  $\varnothing$  10–26 mm,  $\varnothing$   $\frac{3}{8}$ –1". For driving REMS pressing tongs/pressing rings. With dividable tubular arms. In skin package.

	Art.-No.	€
	574000R	227,32



### Accessories

Description	Art.-No.	€
<b>REMS pressing tongs/pressing rings</b> , see page 198–238.		
<b>Adapter tongs Z8</b> for driving REMS pressing rings S (PR-2B)	574702R	144,28
<b>REMS cropping tongs</b> for threaded rods see page 241.		
<b>Carrying bag</b> for drive unit and for 3 pressing tongs	574436R	38,41
<b>Steel case</b> with insert for drive unit and for 3 pressing tongs	574430R	96,53



# REMS Power-Press SE

Electric radial press 32 kN

Universal, handy electric tool for producing pipe pressing joints for all common pressfitting systems.

Pipe pressing joints  $\varnothing$  10 – 108 (110) mm  
 $\varnothing$   $\frac{3}{8}$  – 4"

Complete range of REMS pressing tongs/  
pressing rings for all common pressfitting systems,  
see page 198 – 238.

**REMS Power-Press SE – universal up to  $\varnothing$  110 mm.**

**Secure crimping in seconds.**

**Automatic locking of pressing tongs.**

### System advantage

Only **one** type of pressing tongs/pressing rings for all REMS radial presses 32 kN and suitable radial presses of other makes with 32 kN thrust force.

All pressing tongs marked with \* have another connection and also fit the manual radial press REMS Eco-Press. All pressing rings S (PR-2B) marked with \*\* can also be driven with the manual radial press REMS Eco-Press using the adapter tong Z8.

### Pressing tongs/pressing rings for all common systems

Complete assortment of REMS pressing tongs/pressing rings for all common pressfitting systems (page 198 – 238). Highly durable pressing tongs/pressing rings made of tenacious, specially hardened special steel. Pressing contours of REMS pressing tongs/pressing rings are system-specific and correspond to the respective pressfitting system. Thus perfect system conformity, safe press jointing. Adapter tongs required for driving the REMS (PR) pressing rings, see page 238.

### Design

Compact, robust, job site-proven. Small in size, slender design, drive unit only 4.7 kg. Works anywhere, free-hand, overhead, in confined areas. Secure seating of pressing tongs/adapter tongs by automatic locking. Also suitable for other suitable makes of pressing tongs/pressing chains.

### Pressing operation by touch-control

For reliable service, operating and functional safety. A perfect joint is achieved when pressing tongs close completely. The pressing tongs remain in a closed position until machine is switched and runs into reverse. The perfect pressing joint (completely closed pressing jaws) can be observed.

### Drive

Enormous thrust and pressing force for fast and perfect press jointing. Thrust force 32 kN. Powerful electro-mechanical drive with proven universal motor, 450 W, maintenance-free gear with safety slipping clutch and in-feed system with machine screw spindle. Overload protection. Safety tip switch.



German Quality Product



### Supply format

**REMS Power-Press SE Basic-Pack.** Electric radial press 32 kN for producing pressing joints  $\varnothing$  10 – 108 (110) mm,  $\varnothing$   $\frac{3}{8}$  – 4". For driving REMS pressing tongs/pressing rings and other suitable makes of pressing tongs/pressing rings. Pressing tongs seat with automatic locking. Electro-mechanical drive with proven universal motor 230 V or 110 V, 50 – 60 Hz, 450 W, maintenance-free gear with safety slipping clutch and in-feed system with machine screw spindle, overload protection, safety tip switch. In sturdy steel case.

	Art.-No.	€
	572111 R220	<b>964,30</b>

Other voltages on request.

### Accessories

Description	Art.-No.	€
<b>REMS Power-Press SE Drive Unit</b>	572101 R220	<b>912,40</b>
<b>REMS pressing tongs/pressing rings</b> see page 198 – 238.		
<b>Adapter tongs</b> for REMS pressing rings see page 238.		
<b>REMS cropping tongs</b> for threaded rods see page 241.		
<b>REMS cable shear</b> for electric cable see page 241.		
<b>Steel case</b> with insert	570280 R	<b>110,03</b>



# REMS Power-Press ACC

Electro-hydraulic radial press 32 kN with automatic retraction

Universal, handy electric tool with automatic circuit control for producing pipe pressing joints for all common pressfitting systems.

Pipe pressing joints  $\varnothing$  10 – 108 (110) mm  
 $\varnothing$   $\frac{3}{8}$  – 4"

Complete range of REMS pressing tongs/pressing rings for all common pressfitting systems, see page 198 – 238.

**REMS Power-Press ACC – universal up to  $\varnothing$  110 mm. Secure crimping in seconds. With automatic circuit control. Automatic locking of pressing tongs.**

### System advantage

Only **one** type of pressing tongs/pressing rings for all REMS radial presses 32 kN and suitable radial presses of other makes with 32 kN thrust force.

All pressing tongs marked with \* have another connection and also fit the manual radial press REMS Eco-Press. All pressing rings S (PR-2B) marked with \*\* can also be driven with the manual radial press REMS Eco-Press using the adapter tong Z8.

### Pressing tongs/pressing rings for all common systems

Complete assortment of REMS pressing tongs/pressing rings for all common pressfitting systems (page 198 – 238). Highly durable pressing tongs/pressing rings made of tenacious, specially hardened special steel. Pressing contours of REMS pressing tongs/pressing rings are system-specific and correspond to the respective pressfitting system. Thus perfect system conformity, safe press jointing. Adapter tongs required for driving the REMS (PR) pressing rings, see page 238.

### Design

Compact, robust, job site-proven. Small in size, slender design, drive unit only 4.7 kg. Works anywhere, free-hand, overhead, in confined areas. Ideal weight distribution for single handed operation. Ergonomically designed housing with recessed grip. Swivelling pressing tongs/adapter tongs seat. Secure seating of pressing tongs by automatic locking. Also suitable for other suitable makes of pressing tongs/pressing rings.

### Pressing operation by touch-control with ACC

For reliable service, operating and functional safety. Automatic retraction after completion of pressing operation (automatic circuit control).

### Drive

Enormous thrust and pressing force for fast and perfect press jointing. Thrust force 32 kN. Powerful electro-hydraulic drive with proven universal motor 450 W, robust planetary gear, eccentric reciprocating pump and compact high power hydraulic system. Safety tip switch.



German Quality Product



Info

### Supply format

**REMS Power-Press ACC Basic-Pack.** Electro-hydraulic radial press 32 kN with automatic retraction for producing pressing joints  $\varnothing$  10 – 108 (110) mm,  $\varnothing$   $\frac{3}{8}$  – 4". For driving REMS pressing tongs/pressing rings and other suitable makes of pressing tongs/pressing rings. Pressing tongs seat with automatic locking. Electro-hydraulic drive with proven universal motor 230 V or 110 V, 50 – 60 Hz, 450 W, robust planetary gear, eccentric reciprocating pump and compact high power hydraulic system. Safety tip switch.

Version	Art.-No.	€
In sturdy steel case.	577010R220	<b>1.462,54</b>
In L-Boxx system case.	577013R220	<b>1.504,06</b>

Other voltages on request.



### Accessories

Description	Art.-No.	€
<b>REMS Power-Press ACC Drive Unit</b>	577000R220	<b>1.358,74</b>
<b>REMS pressing tongs/pressing rings</b> see page 198 – 238.		
<b>Adapter tongs</b> for REMS pressing rings see page 238.		
<b>REMS cropping tongs</b> for threaded rods see page 241.		
<b>REMS cable shear</b> for electric cable see page 241.		
<b>Steel case</b> with insert	570280R	<b>110,03</b>
<b>L-Boxx system case</b> with inserts	571283R	<b>146,36</b>



# REMS Power-Press XL ACC

Electro-hydraulic radial press XL 32 kN  
with automatic retraction

Universal, powerful power tool with automatic circuit control for making press joints of all common press fitting systems.

Pipe pressing joints  $\varnothing$  10 – 108 (110) mm  
 $\varnothing$   $\frac{3}{8}$  – 4"

Complete range of REMS pressing tongs/pressing rings/  
pressing rings XL for all common pressfitting systems,  
see page 198 – 238.

**REMS Power-Press XL ACC – universal up to  $\varnothing$  110 mm.**  
**Pressing of  $\varnothing$  10 – 108 mm in just one action.**  
**Ultra-fast, e.g. Geberit Mapress stainless steel  $\varnothing$  108 mm**  
**in only 15 seconds. With automatic circuit control.**  
**Automatic locking of pressing tongs.**

## System advantage

Only **one** type of pressing tongs/pressing rings for all REMS radial presses 32 kN and suitable radial presses of other makes with 32 kN thrust force.

All pressing tongs marked with \* have another connection and also fit the manual radial press REMS Eco-Press. All pressing rings S (PR-2B) marked with \*\* can also be driven with the manual radial press REMS Eco-Press using the adapter tong Z8.

## Pressing tongs/pressing rings for all common systems

Complete assortment of REMS pressing tongs/pressing rings/pressing rings XL for all common pressfitting systems (page 198 – 238). Highly durable pressing tongs/XL pressing rings made of tenacious, specially hardened special steel. Pressing contours of REMS pressing tongs/pressing rings/pressing rings XL are system-specific and correspond to the respective pressfitting system. Thus perfect system conformity, safe press jointing. Adapter tongs are required, as an accessory, for driving the REMS (PR) pressing rings.

## Design

Compact, robust, job site-proven. Small in size, slender design, drive unit only 5.5 kg. Long working stroke for pressings in a single action, ideal for large dimensions. Ultra-fast, e.g. Geberit Mapress stainless steel  $\varnothing$  108 mm in only 15 seconds. Ergonomically designed housing with soft grip and recessed handle. Swivelling pressing tongs/adapter tongs seat. Secure seating of pressing tongs by automatic locking. Also suitable for other suitable makes of pressing tongs/pressing rings. Adjustable hand guard.

## Pressing operation by touch-control with ACC

For reliable service, operating and functional safety. Automatic retraction after completion of pressing operation (automatic circuit control).

## Drive

Enormous thrust and pressing force for fast and perfect press jointing. Thrust force 32 kN. Powerful electro-hydraulic drive with proven universal motor 450 W, robust planetary gear, eccentric reciprocating pump and compact high power hydraulic system. Safety tip switch.



German Quality Product



Info

## Supply format

**REMS Power-Press XL ACC Basic-Pack.** Electro-hydraulic radial press 32 kN with automatic retraction for producing pressing joints  $\varnothing$  10 – 108 (110) mm,  $\varnothing$   $\frac{3}{8}$  – 4". For driving REMS pressing tongs/pressing rings/pressing rings XL and other suitable makes of pressing tongs/pressing rings. Pressing tongs seat with automatic locking. Electro-hydraulic drive with proven universal motor 230 V or 110 V, 50 – 60 Hz, 450 W, robust planetary gear, eccentric reciprocating pump and compact high power hydraulic system. Safety tip switch.

Version	Art.-No.	€
In transport case XL.	579010R220	<b>2.385,32</b>
In XL-Boxx system case.	579012R220	<b>2.344,84</b>

Other voltages on request.



## Accessories

Description	Art.-No.	€
<b>REMS Power-Press XL ACC drive Unit</b>	579000R220	<b>2.096,76</b>
<b>Adapter tongs Z6 XL</b> for driving REMS pressing rings 64.0 – 108.0 XL (PR-3S), 2 1/2 – 4" XL (PR-3S) with REMS Power-Press XL ACC	579120R	<b>373,68</b>
<b>Adapter tongs</b> for other REMS pressing rings see page 238.		
<b>REMS pressing tongs/pressing rings/pressing rings XL</b> see page 198 – 238.		
<b>REMS cropping tongs</b> for threaded rods see page 241.		
<b>REMS cable shear</b> for electric cable see page 241.		
<b>Transport case XL</b> with inlays and practical carrying handles	579240R	<b>288,56</b>
<b>XL-Boxx system case</b> with inserts	579601R	<b>248,08</b>





# REMS Akku-Press E 22V ACC

Cordless radial press 32 kN with automatic circuit control

Universal, handy electric tool with automatic circuit control for producing pipe pressing joints for all common pressfitting systems. Li-Ion 22V Technology. For battery and corded operation.

Pipe pressing joints Ø 10 – 108 (110) mm  
Ø 3/8 – 4"

Complete range of REMS pressing tongs/pressing rings for all common pressfitting systems, see page 198 – 238.

**REMS Akku-Press E 22V ACC – universal up to Ø 110 mm. Secure crimping in seconds. With automatic circuit control. Anti-vibration system. Automatic locking of pressing tongs. Li-Ion 21.6V, 2.5 Ah battery for approx. 200 pressings Viega Profipress DN 15 with one battery charge\*.**

### System advantage

Only **one** type of pressing tongs/pressing rings for all REMS radial presses 32 kN and suitable radial presses of other makes with 32 kN thrust force.

All pressing tongs marked with \* have another connection and also fit the manual radial press REMS Eco-Press. All pressing rings S (PR-2B) marked with \*\* can also be driven with the manual radial press REMS Eco-Press using the adapter tong Z8.

### Pressing tongs/pressing rings for all common systems

Complete assortment of REMS pressing tongs/pressing rings for all common pressfitting systems (page 198 – 238). Highly durable pressing tongs/pressing rings made of tenacious, specially hardened special steel. Pressing contours of REMS pressing tongs/pressing rings are system-specific and correspond to the respective pressfitting system. Thus perfect system conformity, safe press jointing. Adapter tongs required for driving the REMS (PR) pressing rings, see page 238.

### Design

Compact, handy, super light. Drive unit with battery only 3.3 kg. Drive unit with pressing tongs V 15 only 35.5 cm long. Works anywhere, free-hand, overhead, also in particularly tight areas. Works anywhere, free-hand, overhead, in confined areas. Optimum weight distribution for single-hand operation. Drive unit with inserted pressing tongs can be put down on the battery ready to pick up. Ergonomically designed housing and soft grips. LED work light for illuminating the work place. Machine status check. Swivelling pressing tongs seat, rotation angle > 360°. Secure seating of pressing tongs/adapter tongs by automatic locking. Also for other suitable makes of pressing tongs/pressing rings.

### Anti-vibration system

Special drive technology with weight balancing and soft grips for low-vibration, fatigue-free pressing.

### Pressing operation by touch-control with ACC

For reliable service, operating and functional safety. Automatic retraction after completion of pressing operation (automatic circuit control).

### Drive

Enormous thrust and pressing force for fast and perfect press jointing. Thrust force 32 kN. Powerful electro-hydraulic drive with powerful battery motor 21.6 V, 380 W output, robust planetary gear, eccentric reciprocating pump and compact high power hydraulic system. Safety tip switch.

### Battery or mains operation

Li-Ion 22V Technology. Highly resistant Li-Ion 21.6V battery with 2.5, 4.4, 5.0 or 9.0 Ah capacity, for long service life. Light and powerful. Li-Ion 21.6 V, 2.5 Ah batteries for approx. 200 pressings, 4.4 Ah for approx. 350 pressings, 5.0 Ah for approx. 400 pressings, 9.0 Ah for approx. 720 pressings Viega Profipress DN 15 with one battery charge\*. Graduated charging status check by coloured LEDs. Operating temperature range – 10 to + 60 °C. No memory effect for maximum battery power. Rapid charger 100 – 240V, 70W. Rapid charger 100 – 240V, 290W, for shorter charging times, as accessory. Voltage supply 220 – 240V/21.6 V, 15 A output, for mains operation instead of Li-Ion battery 21.6 V, as accessory.



German Quality Product

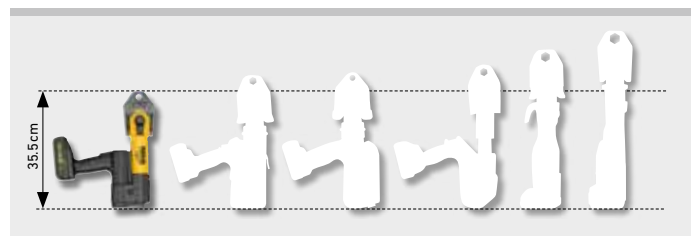

The little one amongst the big. Only 3.3 kg.



## Supply format

**REMS Akku-Press E 22 V ACC Basic-Pack.** Cordless radial press 32 kN with automatic circuit control for making press joints Ø 10 – 108 (110) mm, Ø 3/8 – 4". For driving REMS pressing tongs/pressing rings and other suitable makes of pressing tongs/pressing rings. Swivelling pressing tongs seat with automatic locking. Electro-hydraulic drive with powerful battery motor 21.6 V, 380 W, robust planetary gear, eccentric reciprocating pump and compact high power hydraulic system. Anti-vibration system. Safety tip switch. LED work light. Battery Li-Ion 21.6 V, 2.5 Ah, rapid charger 100 – 240 V, 50 – 60 Hz, 70 W.

Version	Art.-No.	€
In sturdy steel case.	576016R220	<b>1.806,12</b>
In L-Boxx system case.	576017R220	<b>1.847,64</b>

Other voltages on request.

## Accessories

Description	Art.-No.	€
<b>REMS pressing tongs/pressing rings</b> see page 198 – 238.		
<b>Adapter tongs</b> for REMS pressing rings see page 238.		
<b>REMS cropping tongs</b> for threaded rods see page 241.		
<b>REMS cable shear</b> for electric cable see page 241.		
<b>REMS Akku-Press E 22 V ACC drive unit,</b> without battery	576006R22	<b>1.255,98</b>
<b>Battery Li-Ion 21.6 V, 2.5 Ah</b>	571571R22	<b>258,46</b>
<b>Battery Li-Ion 21.6 V, 4.4 Ah</b>	571574R22	<b>372,64</b>
<b>Battery Li-Ion 21.6 V, 5.0 Ah</b>	571581R22	<b>310,36</b>
<b>Battery Li-Ion 21.6 V, 9.0 Ah</b>	571583R22	<b>414,16</b>
<b>Rapid charger 100 – 240 V, 50 – 60 Hz, 90 W</b>	571585R220	<b>175,42</b>
<b>Rapid charger 100 – 240 V, 50 – 60 Hz, 290 W</b>	571587R220	<b>414,16</b>
<b>Voltage supply 220 – 240 V/21.6 V, 50 – 60 Hz, 15 A,</b> for mains operation instead of battery Li-Ion 21.6 V.	571567R220	<b>414,16</b>
<b>Steel case with inlay</b>	571290R	<b>110,03</b>
<b>L-Boxx system case with inserts</b>	576345R	<b>146,36</b>
<b>REMS Lumen 2800 22V,</b> cordless LED flood light, see page 111		



# REMS Akku-Press 22 V ACC

Cordless radial press 32 kN with automatic circuit control, pressure monitoring and result display

Universal, handy electric tool with automatic circuit control, pressure monitoring and result display, for producing pipe pressing joints for all common pressfitting systems. Li-Ion 22V Technology. For battery and corded operation.

Pipe pressing joints  $\varnothing$  10–108 (110) mm  
 $\varnothing$  3/8–4"

Complete range of REMS pressing tongs/pressing rings for all common pressfitting systems, see page 198–238.

**REMS Akku-Press 22 V ACC – universal up to  $\varnothing$  110 mm. Secure crimping in seconds. With automatic circuit control, pressure monitoring and result display. Anti-vibration system. Automatic locking of pressing tongs. Li-Ion 21.6V, 2.5 Ah battery for approx. 200 pressings Viega Profipress DN 15 with one battery charge\*.**

### System advantage

Only **one** type of pressing tongs/pressing rings for all REMS radial presses 32 kN and suitable radial presses of other makes with 32 kN thrust force.

All pressing tongs marked with \* have another connection and also fit the manual radial press REMS Eco-Press. All pressing rings S (PR-2B) marked with \*\* can also be driven with the manual radial press REMS Eco-Press using the adapter tong Z8.

### Pressing tongs/pressing rings for all common systems

Complete assortment of REMS pressing tongs/pressing rings for all common pressfitting systems (page 198–238). Highly durable pressing tongs/pressing rings made of tenacious, specially hardened special steel. Pressing contours of REMS pressing tongs/pressing rings are system-specific and correspond to the respective pressfitting system. Thus perfect system conformity, safe press jointing. Adapter tongs required for driving the REMS (PR) pressing rings, see page 238.

### Design

Compact, handy, super light. Drive unit with battery only 3.3 kg. Drive unit with pressing tongs V 15 only 35.5 cm long. Works anywhere, free-hand, overhead, also in particularly tight areas. Works anywhere, free-hand, overhead, in confined areas. Optimum weight distribution for single-hand operation. Drive unit with inserted pressing tongs can be put down on the battery ready to pick up. Ergonomically designed housing and soft grips. LED work light for illuminating the work place. Machine status check. Swivelling pressing tongs seat, rotation angle  $> 360^\circ$ . Secure seating of pressing tongs/adapter tongs by automatic locking. Also for other suitable makes of pressing tongs/pressing rings.

### Pressure monitoring and result display

Electronic pressure sensor for thrust force monitoring. Pressure evaluation after the pressing process. Result display with 2-coloured white/red LED.

### Anti-vibration system

Special drive technology with weight balancing and soft grips for low-vibration, fatigue-free pressing.

### Pressing operation by touch-control with ACC

For reliable service, operating and functional safety. Automatic retraction after completion of pressing operation (automatic circuit control).

### Drive

Enormous thrust and pressing force for fast and perfect press jointing. Thrust force 32 kN. Powerful electro-hydraulic drive with powerful battery motor 21.6V, 380 W output, robust planetary gear, eccentric reciprocating pump and compact high power hydraulic system. Safety tip switch.

### Battery or mains operation

Li-Ion 22V Technology. Highly resistant Li-Ion 21.6V battery with 2.5, 4.4, 5.0 or 9.0 Ah capacity, for long service life. Light and powerful. Li-Ion 21.6V, 2.5 Ah batteries for approx. 200 pressings, 4.4 Ah for approx. 350 pressings, 5.0 Ah for approx. 400 pressings, 9.0 Ah for approx. 720 pressings Viega Profipress DN 15 with one battery charge\*. Graduated charging status check by coloured LEDs. Operating temperature range  $-10$  to  $+60^\circ\text{C}$ . No memory effect for maximum battery power. Rapid charger 100–240V, 90W. Rapid charger 100–240V, 290W, for shorter charging times, as accessory. Voltage supply 220–240V/21.6V, 15A output, for mains operation instead of Li-Ion battery 21.6V, as accessory.



German Quality Product



Info

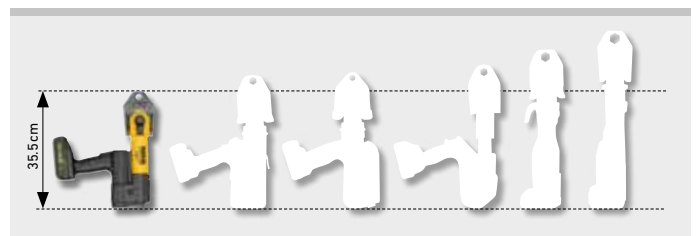

The little one amongst the big. Only 3.3 kg.



# REMS Akku-Press 22 V ACC

Cordless radial press 32 kN with automatic circuit control, pressure monitoring and result display



## Supply format

**REMS Akku-Press 22 V ACC Basic-Pack.** Cordless radial press 32 kN with automatic circuit control, pressure monitoring and result display, for making press joints Ø 10–108 (110) mm, Ø 3/8–4". For driving REMS pressing tongs/pressing rings and other suitable makes of pressing tongs/pressing rings. Swivelling pressing tongs seat with automatic locking. Electro-hydraulic drive with powerful battery motor 21.6 V, 380 W, robust planetary gear, eccentric reciprocating pump and compact high power hydraulic system. Anti-vibration system. Safety tip switch. LED work light. Battery Li-Ion 21.6 V, 2.5 Ah, rapid charger 100–240 V, 50–60 Hz, 90 W.

Version	Art.-No.	€
In sturdy steel case.	576010R220	<b>2.117,52</b>
In L-Boxx system case.	576011R220	<b>2.159,04</b>

Other voltages on request.

## Accessories

Description	Art.-No.	€
<b>REMS pressing tongs/pressing rings</b> see page 198–238.		
<b>Adapter tongs</b> for REMS pressing rings see page 238.		
<b>REMS cropping tongs</b> for threaded rods see page 241.		
<b>REMS cable shear</b> for electric cable see page 241.		
<b>REMS Akku-Press 22 V ACC drive unit,</b> without battery	576000R22	<b>1.546,62</b>
<b>Battery Li-Ion 21.6 V, 2.5 Ah</b>	571571R22	<b>258,46</b>
<b>Battery Li-Ion 21.6 V, 4.4 Ah</b>	571574R22	<b>372,64</b>
<b>Battery Li-Ion 21.6 V, 5.0 Ah</b>	571581R22	<b>310,36</b>
<b>Battery Li-Ion 21.6 V, 9.0 Ah</b>	571583R22	<b>414,16</b>
<b>Rapid charger 100–240 V, 50–60 Hz, 90 W</b>	571585R220	<b>175,42</b>
<b>Rapid charger 100–240 V, 50–60 Hz, 290 W</b>	571587R220	<b>414,16</b>
<b>Voltage supply 220–240 V/21.6 V, 50–60 Hz, 15 A,</b> for mains operation instead of battery Li-Ion 21.6 V.	571567R220	<b>414,16</b>
<b>Steel case with inlay</b>	571290R	<b>110,03</b>
<b>L-Boxx system case with inserts</b>	576345R	<b>146,36</b>
<b>REMS Lumen 2800 22 V,</b> cordless LED flood light, see page 111		



# REMS Akku-Press 22V Connected

Cordless radial press 32 kN with Connected functionality via Wi-Fi radio standard and OLED display

Universal, handy electric tool with Connected functionality via Wi-Fi radio standard and OLED display for producing pipe pressing joints for all common pressfitting systems. Li-Ion 22V Technology. For battery and corded operation.

Pipe pressing joints Ø 10 – 108 (110) mm  
Ø 3/8 – 4"

Complete range of REMS pressing tongs/pressing rings for all common pressfitting systems, see page 198 – 238.

**REMS Akku-Press 22V Connected – universal up to Ø 110 mm. Secure crimping in seconds. With selectable ACC drive mode. Connected functionality via Wi-Fi radio standard and OLED display. Pressure monitoring and result display. Anti-vibration system. Automatic locking of pressing tongs. Electrically monitored closing position of the tong retaining bolt. Voice recordings with voice recognition. Creating reports with texts and pictures. Geolocalisation of the pressing sites. Li-Ion 21.6V, 2.5 Ah battery for approx. 200 pressings. Viiega Profipress DN 15 with one battery charge\*.**

## System advantage

Only **one** type of pressing tongs/pressing rings for all REMS radial presses 32 kN and suitable radial presses of other makes with 32 kN thrust force.

All pressing tongs marked with \* have another connection and also fit the manual radial press REMS Eco-Press. All pressing rings S (PR-2B) marked with \*\* can also be driven with the manual radial press REMS Eco-Press using the adapter tong Z8.

## Pressing tongs/pressing rings for all common systems

Complete assortment of REMS pressing tongs/pressing rings for all common pressfitting systems (page 198 – 238). Highly durable pressing tongs/pressing rings made of tenacious, specially hardened special steel. Pressing contours of REMS pressing tongs/pressing rings are system-specific and correspond to the respective pressfitting system. Thus perfect system conformity, safe press jointing. Adapter tongs required for driving the REMS (PR) pressing rings, see page 238.

## Design

Compact, handy, super light. Drive unit with battery only 3.3 kg. Drive unit with pressing tongs V 15 only 36.3 cm long. Works anywhere, free-hand, overhead, also in particularly tight areas. Works anywhere, free-hand, overhead, in confined areas. Optimum weight distribution for single-hand operation. Drive unit with inserted pressing tongs can be put down on the battery ready to pick up. Ergonomically designed housing with strong carrying ring for a shoulder strap. Soft-grip surfaces. Two rows of LED work lights for illuminating the workplace as required, adjustable brightness in 4 stages and lighting time. Machine status check with charging state indication by 2-coloured green/red LED. Swivelling pressing tongs seat, rotation angle > 360°. Secure seating of pressing tongs/adapter tongs by automatic locking. Electrically monitored closing position of the tong retaining bolt. Also for other suitable makes of pressing tongs/pressing rings.

## Connected functionality

REMS Akku-Press 22V Connected offers various additional functionalities such as, for example: Recording of measuring/pressing data, creation of reports with your own company logo, display of error messages, configuration of the product (language, date, time, time zone, pressure unit, LED lighting time and LED brightness, standby time, ACC drive mode, information signal tones, etc.), set-up of usage bars (immediate bar or feedback interval as anti-theft, time and date ranges for barring times, limitation of the number of performable pressings), geolocalisation of the pressing sites, conversion of voice recordings into editable text, upload and save images of pressings, display of notices (annual inspection and periodic testing, new firmware version, battery state, etc.), download and installation of new firmware version.

## Pressure monitoring and result display

Electronic pressure sensor for thrust force monitoring. Monitoring and display of pressure and maximum pressure during the pressing process. Pressure analysis after the pressing process with result display in the OLED display and with coloured LEDs. Display of the pressure-time diagram of the performed pressing directly in the OLED display. Storage of the measured/pressing data.

## Voice recordings with voice recognition

A voice recording can be made and stored for every pressing with the microphone integrated into the drive unit. These can be converted into editable text and transferred to reports in the Service Portal.

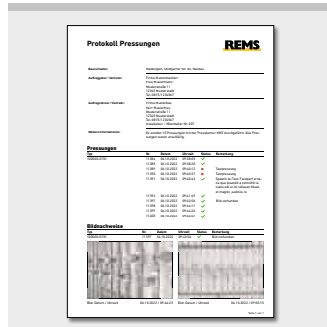

German Quality Product



Info

# REMS Akku-Press 22V Connected

Cordless radial press 32 kN with Connected functionality via Wi-Fi radio standard and OLED display

## Wi-Fi connection to the Cloud

REMS Akku-Press 22V Connected sends collected data (measuring and pressing data, error messages, configuration of the product, voice recordings, etc.) to the Cloud after registration and with an existing Internet connection. The data are processed and stored there. The user can access these data, upload and store pictures of pressings, create reports with texts and pictures and change the drive unit settings through the REMS Service Portal. The changes are transferred back to the drive unit via an existing Internet connection.

## Selectable ACC drive mode

When ACC drive mode is switched on, the drive unit ends the pressing process automatically, emits an acoustic signal (clicking) and automatically returns (automatic circuit control). When ACC mode is switched off, the drive unit stops just before reaching the required pressure to be able to monitor complete closing of the pressing tongs, pressing ring and pressing segments better at the end of the pressing process. The pressing process must be continued by pressing the safety switch again. The drive unit ends the pressing process automatically, emits an acoustic signal (clicking) and automatically returns (automatic circuit control).

## Drive

Enormous thrust and pressing force for fast and perfect press jointing. Thrust force 32 kN. High-performance, electro-hydraulic drive with powerful, brushless, maintenance free 21.6 V, 400 W battery motor, robust planetary gear, eccentric piston pump and compact high-performance hydraulic system. Safety switch.

## Anti-vibration system

Special drive technology with weight balancing and soft grips for low-vibration, fatigue-free pressing.

## Battery or mains operation

Li-Ion 22V Technology. Highly resistant Li-Ion 21.6V battery with 2.5, 4.4, 5.0 or 9.0Ah capacity, for long service life. Light and powerful. Li-Ion 21.6V, 2.5Ah batteries for approx. 210 pressings, 4.4 Ah for approx. 370 pressings, 5.0Ah for approx. 420 pressings, 9.0Ah for approx. 750 pressings Viega Profipress DN 15 with one battery charge\*. Graduated charging status check by coloured LEDs. Operating temperature range - 10 to + 60 °C. No memory effect for maximum battery power. Rapid charger 100-240V, 90W. Rapid charger 100-240V, 290W, for shorter charging times, as accessory. Voltage supply 220-240V/21.6V, 15A output, for mains operation instead of Li-Ion battery 21.6 V, as accessory.

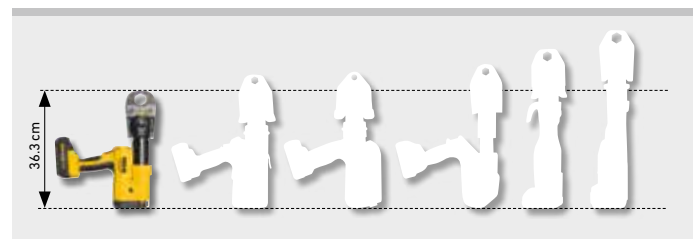

The little one amongst the big. Only 3.3 kg.



Electrically monitored closing position of the tong retaining bolt.



## Supply format

**REMS Akku-Press 22V Connected Basic-Pack.** Cordless radial press 32 kN with selectable ACC drive mode, Connected functionality via Wi-Fi radio standard and OLED display, pressure monitoring and result display, for making press joints Ø 10 – 108 (110) mm, Ø 3/8 – 4". For driving REMS pressing tongs/pressing rings and other suitable makes of pressing tongs/pressing rings. Swivelling pressing tongs seat with automatic locking. Electrically monitored closing position of the tong retaining bolt. Electro-hydraulic drive with powerful, brushless, maintenance free 21.6 V, 400 W battery motor, robust planetary gear, eccentric piston pump and compact high-performance hydraulic system. Anti-vibration system. Safety tip switch. LED work lights. Battery Li-Ion 21.6 V, 2.5 Ah, rapid charger 100-240V, 50-60Hz, 90W.

Version	Art.-No.	€
In sturdy steel case.	576014R220	3.155,52
In L-Boxx system case.	576015R220	3.197,04

Other voltages on request.

## Accessories

Description	Art.-No.	€
<b>REMS pressing tongs/pressing rings</b> see page 198 – 238.		
<b>Adapter tongs</b> for REMS pressing rings see page 238.		
<b>REMS cropping tongs</b> for threaded rods see page 241.		
<b>REMS cable shear</b> for electric cable see page 241.		
<b>REMS Akku-Press 22V Connected drive unit, without battery</b>	576003R22	2.584,62
<b>Battery Li-Ion 21.6V, 2.5 Ah</b>	571571R22	258,46
<b>Battery Li-Ion 21.6V, 4.4 Ah</b>	571574R22	372,64
<b>Battery Li-Ion 21.6V, 5.0 Ah</b>	571581R22	310,36
<b>Battery Li-Ion 21.6V, 9.0 Ah</b>	571583R22	414,16
<b>Rapid charger 100-240V, 50-60 Hz, 90W</b>	571585R220	175,42
<b>Rapid charger 100-240V, 50-60 Hz, 290W</b>	571587R220	414,16
<b>Voltage supply 220-240V/21.6V, 50-60 Hz, 15A, for mains operation instead of battery Li-Ion 21.6 V.</b>	571567R220	414,16
<b>Steel case with inlay</b>	571290R	110,03
<b>L-Boxx system case with inserts</b>	576345R	146,36
<b>REMS Lumen 2800 22V, cordless LED flood light, see page 111</b>		



# REMS Akku-Press XL 45 kN 22 V ACC

Cordless radial press XL 45 kN  
with automatic circuit control

Universal, powerful electric tool with automatic circuit control for producing XL pipe pressing joints for all common pressfitting systems. Thrust force 45 kN. Li-Ion 22V Technology. For battery and corded operation.

Pipe pressing joints XL	Ø 64 – 108 mm
	Ø 2½ – 4"

Complete range of REMS pressing rings XL for all common pressfitting systems, see page 198 – 238.

**REMS Akku-Press XL 45 kN 22 V ACC – the powerful one with 45 kN thrust force. Pressing of Ø 64 – 108 mm in a single action. Anti-vibration system. Super fast, e.g. Geberit Mapress stainless steel Ø 108 mm in just 15 s. With automatic circuit control. Secure seating of adapter tongs by automatic locking.**

**Li-Ion 21.6 V, 5.0 Ah battery, for approx. 150 pressings Geberit Mapress stainless steel Ø 108.0 mm with one battery charge\*.**

### Pressing rings XL for all common systems

Full range of REMS pressing rings XL for driving by REMS Akku-Press XL 45 kN 22 V ACC (page 198 – 238). Highly durable pressing rings XL made of tenacious, specially hardened special steel. Pressing contours of REMS pressing rings XL are system-specific and correspond to the respective pressfitting system. Thus perfect system conformity, safe press jointing.

### Adapter tongs Z7 XL 45 kN

For driving REMS pressing rings XL by REMS Akku-Press XL 45 kN 22 V ACC adapter tongs Z7 XL 45 kN are required.

### Design

Compact, robust, job site-proven. Small in size, slender design, drive unit with battery only 6.5 kg. Long working stroke for pressings in a single action. Super fast, e.g. Geberit Mapress stainless steel Ø 108 mm in just 15 s. Drive unit with inserted pressing tongs can be put down on the battery ready to pick up. Ergonomically designed housing and soft grips. LED work light for illuminating the work place. Machine status check. Swivelling pressing ring seat, rotation angle > 360°. Secure seating of adapter tongs by automatic locking.

### Anti-vibration system

Special drive technology with weight balancing and soft grips for low-vibration, fatigue-free pressing.

### Pressing operation by touch-control with ACC

For reliable service, operating and functional safety. Automatic retraction after completion of pressing operation (automatic circuit control).

### Drive

Enormous thrust and pressing force for fast and perfect press jointing. Thrust force 45 kN. Powerful electro-hydraulic drive with powerful battery motor 21.6 V, 380 W output, robust planetary gear, eccentric dual-piston pump and compact high power hydraulic system. Safety tip switch.

### Battery or mains operation

Li-Ion 22V Technology. Highly resistant Li-Ion 21.6 V battery with 4.4, 5.0 or 9.0 Ah capacity, for long service life. Light and powerful. Li-Ion 21.6 V, 4.4 Ah batteries for approx. 130 pressings, 5.0 Ah batteries for approx. 150 pressings, 9.0 Ah for approx. 270 pressings Geberit Mapress stainless steel Ø 108.0 mm with one battery charge\*. Graduated charging status check by coloured LEDs. Operating temperature range – 10 to + 60 °C. No memory effect for maximum battery power. Rapid charger 100 – 240 V, 90 W. Rapid charger 100 – 240 V, 290 W, for shorter charging times, as accessory. Voltage supply 220 – 240 V/21.6 V, 40 A output, for mains operation instead of Li-Ion battery 21.6 V, as accessory.



German Quality Product



Info



## Supply format

**REMS Akku-Press XL 45 kN 22 V ACC Basic-Pack Z7.** Cordless radial press 45 kN with automatic circuit control for making press joints XL Ø 64 – 108 mm, Ø 2½ – 4". For driving REMS pressing rings XL. Swivelling pressing ring seat with automatic locking. Electro-hydraulic drive with powerful battery motor 21.6 V, 380 W, robust planetary gear, eccentric dual-piston pump and compact high power hydraulic system. Anti-vibration system. Safety tip switch. LED work light. Battery Li-Ion 21.6 V, 5.0 Ah, rapid charger 100 – 240 V, 50 – 60 Hz, 90 W. Adapter tongs Z7 XL 45 kN. In XL-Boxx system case.

	Art.-No.	€
	579014R220	<b>3.193,93</b>

Other voltages on request.

## Accessories

Description	Art.-No.	€
<b>REMS Akku-Press XL 45 kN 22 V ACC drive unit,</b> without battery	579001R22	<b>2.065,62</b>
<b>Adapter tongs Z7 XL 45 kN</b> for driving REMS pressing rings 64.0 – 108.0 XL (PR-3S), 2½ – 4" XL (PR-3S), 2½ – 4" XL (PR-3B) with REMS Akku-Press XL 45 kN 22 V ACC	579123R	<b>394,44</b>

## REMS pressing rings XL see page 198 – 238

<b>Battery Li-Ion 21.6 V, 4.4 Ah</b>	571574R22	<b>372,64</b>
<b>Battery Li-Ion 21.6 V, 5.0 Ah</b>	571581R22	<b>310,36</b>
<b>Battery Li-Ion 21.6 V, 9.0 Ah</b>	571583R22	<b>414,16</b>
<b>Rapid charger 100 – 240 V, 50 – 60 Hz, 90 W</b>	571585R220	<b>175,42</b>
<b>Rapid charger 100 – 240 V, 50 – 60 Hz, 290 W</b>	571587R220	<b>414,16</b>
<b>Voltage supply 220 – 240 V/21.6 V, 50 – 60 Hz, 40 A,</b> for mains operation instead of battery Li-Ion 21.6 V	571578R220	<b>517,96</b>
<b>XL-Boxx system case with inserts</b>	579601R	<b>248,08</b>

**REMS Lumen 2800 22 V,** cordless LED flood light, see page 111



**for all common pressfitting systems**

**Select REMS pressing tongs/  
REMS pressing rings yourself!**

Find the desired press fitting system in the table below and choose the size of pressing tongs/pressing rings that you require. Please note that pressfitting systems for gas installation may only be pressed with the pressing tongs/pressing rings which are highlighted in yellow in the table.

Highly durable pressing tongs/pressing rings made of tenacious, specially hardened special steel. Pressing contours of REMS pressing tongs/pressing rings are system-specific and correspond with the respective pressfitting system. Thus perfect system-conformity, safe press jointing. Pressing jaws of pressing tongs/pressing rings manufactured on CNC production centres ensure high-precision machining of pressing contour. Low production tolerances as a result.

Driven by REMS radial presses 32 kN and suitable radial presses of other makes with 32 kN thrust force or, if the system requires, by REMS Akku-Press XL 45 kN 22V ACC with 45 kN thrust force, see the table below. Adapter tongs (page 238) required for driving REMS (PR) pressing rings. All pressing tongs marked with \* have an optional connection for manual drive through the radial press REMS Eco-Press. All pressing rings S (PR-2B) marked with \*\* can also be driven with the manual radial press REMS Eco-Press (page 185) using the adapter tong Z8.

Read and observe the instructions for use and the installation instructions of the system provider/manufacturer.

**REMS pressing tongs (PZ-2B)**

REMS pressing tongs (PZ-2B) with 2 swivellable monoblock pressing jaws. Most sold standard version. REMS ACz, Fz, RFz, RFz, VMPz pressing tongs with teeth prevent formation of burr on the pressfitting (Patent EP 2 027 971).

**REMS pressing tongs (PZ-4G)**

REMS pressing tongs (PZ-4G) with two pivoted, parallel aligned pressing segments for linear pressing of midsize dimensions.

**REMS pressing tongs (PZ-S)**

REMS pressing tongs (S) with one fixed and two pivoted pressing segments, for midsize dimensions. REMS VMPz pressing tongs with teeth prevent formation of burr on the pressfitting.

**REMS pressing rings (PR-3S)**

REMS pressing ring (PR-3S) with 3 pressing segments, 2 swivel guided, for large dimension complex pressings. Ideal pressing through radially controlled movement of pressing segments. Adapter tongs required, see page 238.

**REMS pressing rings (PR-3B)**

REMS pressing rings (PR-3B) with 3 pressing segments for high quality, large dimension pressings Optimum pressing by radially controlled movement of the pressing segments. Adapter tongs required, see page 238. REMS VAUFz, VFz, VMPz, VUSFz pressing rings with teeth prevent formation of burr on the pressfitting.

**REMS pressing ring (PR-2B)**

REMS pressing ring (PR-2B) with 2 pressing jaws, for secure engagement of the pressing jaws in tight spaces, for midsize dimensions. Adapter tongs required for driving the REMS (PR-2B) pressing rings, see page 238.

**REMS pressing ring S (PR-2B)**

REMS pressing ring S (PR-2B), continuously swivellable, with 2 pressing jaws, for secure engagement of the pressing jaws in places of difficult access. Adapter tongs required for driving the REMS S (PR-2B) pressing rings, see page 238.

**Traceability according to EN 1775:2007**

REMS pressing tongs/pressing rings with pressing contour F, M, V, SA, B, RN and UP have worked a specific marking into the pressing contour which leaves a lasting impression on the pressed fitting after the pressing process. This enables the user to check again whether the most suitable pressing tongs or the suitable pressing ring have been used to make the pressfit connection even after the pressing process.

With this traceability REMS fulfils the recommendations of the European standard EN 1775:2007 for the installation of pressfitting systems for gas.

**Confirmation of suitability**

See page 239.

**Hold-Harmless and Indemnification Agreement**

See page 240.

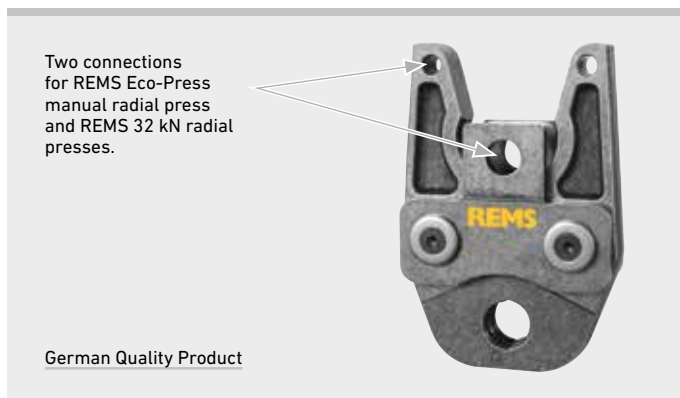

REMS pressing tongs (PZ-2B)



REMS pressing tongs (PZ-4G)



REMS pressing tongs (PZ-S)



REMS pressing rings (PR-3S)



REMS pressing rings (PR-3B)



REMS pressing rings (PR-2B)



REMS pressing ring S (PR-2B), continuously swivellable

# REMS pressing tongs

## REMS pressing rings

Accessories for REMS radial presses (except for REMS Mini-Press) and suitable radial presses of other makes

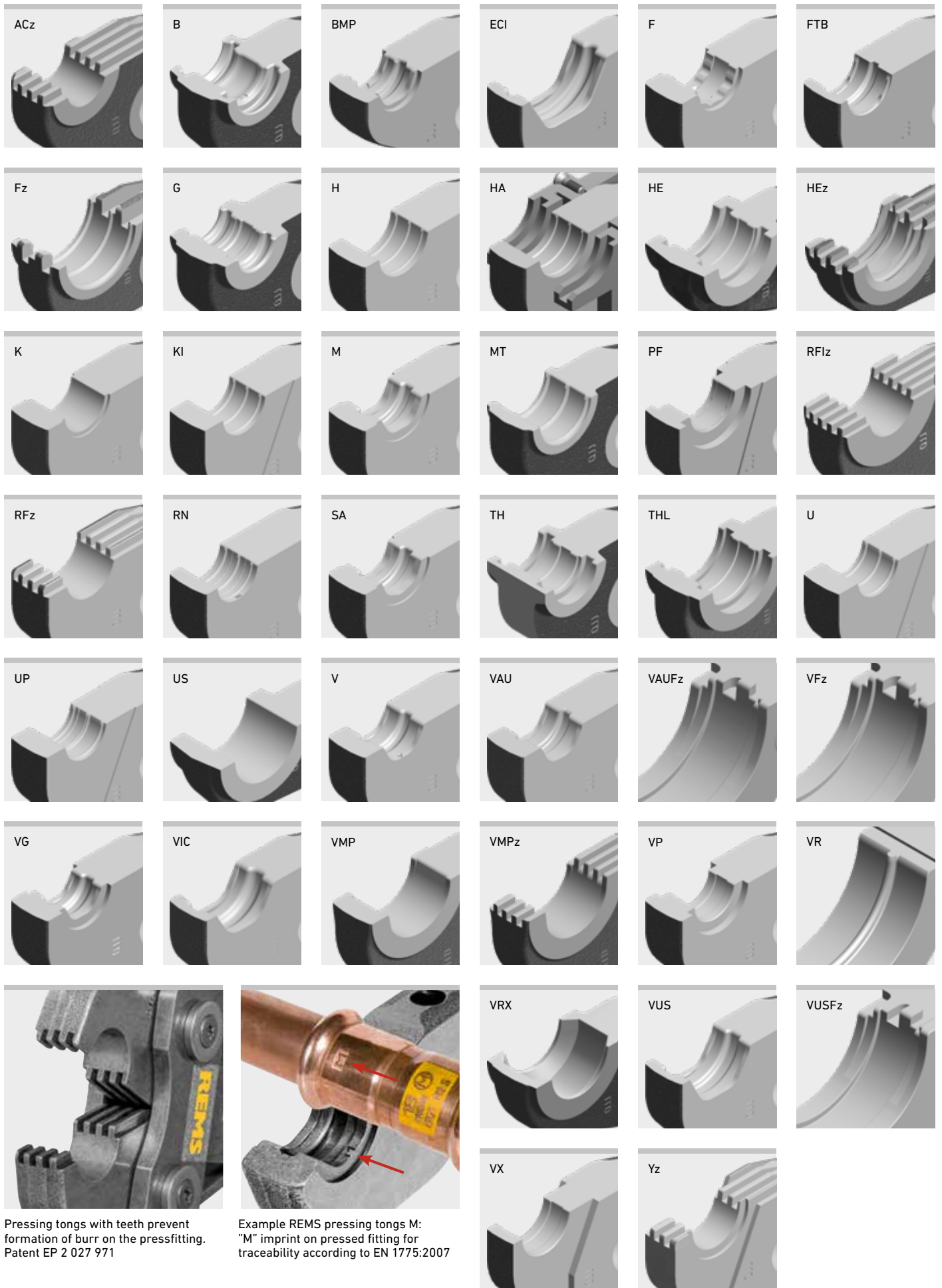

Pressing tongs with teeth prevent formation of burr on the pressfitting. Patent EP 2 027 971

Example REMS pressing tongs M: "M" imprint on pressed fitting for traceability according to EN 1775:2007





# REMS pressing tongs REMS pressing rings

Accessories for REMS radial presses (except for REMS Mini-Press)  
and suitable radial presses of other makes

System	Pressing tongs/ pressing rings	Driven by adapter tongs	Art.-No.	€	System	Pressing tongs/ pressing rings	Driven by adapter tongs	Art.-No.	€
AC-FIX PRESS (Global Piping Systems)	H 12*		570300	168,10	AHLSELL A-press elförzinkad V	V 12		570107	154,61
	H 16*		570320	168,10		V 15		570115	154,61
	H 20*		570350	168,10		V 18		570125	154,61
	H 25*		570360	168,10		V 22		570135	154,61
	H 32		570380	168,10		V 28		570145	154,61
	RFz 12*		571320	194,05		V 35		570155	154,61
	RFz 16*		571325	194,05		V 42		570165	360,13
	RFz 20*		571330	194,05		V 54		570175	370,51
	RFz 25		571335	194,05		V 12 S (PR-2B)	Z8	574748 R	124,51
	RFz 32		571340	194,05		V 15 S (PR-2B)	Z8	574752 R	124,51
	U 16*		570765	174,33		V 18 S (PR-2B)	Z8	574756 R	124,51
	U 20*		570775	174,33		V 22 S (PR-2B)	Z8	574758 R	124,51
	U 25*		570780	174,33		V 28 S (PR-2B)	Z8	574760 R	124,51
	U 32		570785	204,43		V 35 S (PR-2B)	Z8	574762 R	136,96
	VX 16*		571635	214,81		AHLSELL	M 12	570100	154,61
	VX 20*		571640	214,81		A-press koppar M	M 15	570110	154,61
	M 18					M 18		570120	154,61
	M 22					M 22		570130	154,61
	M 28					M 28		570140	154,61
	M 35					M 35		570150	154,61
M 42 (PR-3S)	Z2	572706 R	672,57	M 42 (PR-3S)	Z2	572706 R	672,57		
M 54 (PR-3S)	Z2	572708 R	672,57	M 54 (PR-3S)	Z2	572708 R	672,57		
M 76,1 XL (PR-3S)	Z6 XL <sup>3)</sup> / Z7 XL 45 kN <sup>4)</sup>	579101 R	1.161,47	M 76,1 XL (PR-3S)	Z6 XL <sup>3)</sup> / Z7 XL 45 kN <sup>4)</sup>	579101 R	1.161,47		
M 88,9 G XL (PR-3S)	Z6 XL <sup>3)</sup> / Z7 XL 45 kN <sup>4)</sup>	579110 R	1.355,58	M 88,9 G XL (PR-3S)	Z6 XL <sup>3)</sup> / Z7 XL 45 kN <sup>4)</sup>	579110 R	1.355,58		
M 108,0 G XL (PR-3S)	Z6 XL <sup>3)</sup> / Z7 XL 45 kN <sup>4)</sup>	579111 R	1.355,58	M 108,0 G XL (PR-3S)	Z6 XL <sup>3)</sup> / Z7 XL 45 kN <sup>4)</sup>	579111 R	1.355,58		
M 12 S (PR-2B)	Z8	574736 R	124,51	M 15 S (PR-2B)	Z8	574738 R	124,51		
M 15 S (PR-2B)	Z8	574738 R	124,51	M 18 S (PR-2B)	Z8	574740 R	124,51		
M 18 S (PR-2B)	Z8	574740 R	124,51	M 22 S (PR-2B)	Z8	574742 R	124,51		
M 22 S (PR-2B)	Z8	574742 R	124,51	M 28 S (PR-2B)	Z8	574744 R	124,51		
M 28 S (PR-2B)	Z8	574744 R	124,51	M 35 S (PR-2B)	Z8	574746 R	136,96		
M 35 S (PR-2B)	Z8	574746 R	136,96	AHLSELL	V 12	570107	154,61		
				A-press koppar V	V 15	570115	154,61		
				V 18		570125	154,61		
				V 22		570135	154,61		
				V 28		570145	154,61		
				V 35		570155	154,61		
				V 42		570165	360,13		
				V 54		570175	370,51		
				V 12 S (PR-2B)	Z8	574748 R	124,51		
				V 15 S (PR-2B)	Z8	574752 R	124,51		
				V 18 S (PR-2B)	Z8	574756 R	124,51		
				V 22 S (PR-2B)	Z8	574758 R	124,51		
				V 28 S (PR-2B)	Z8	574760 R	124,51		
				V 35 S (PR-2B)	Z8	574762 R	136,96		
				AHLSELL	M 15	570110	154,61		
				A-press rostfritt	M 18	570120	154,61		
				M 22		570130	154,61		
				M 28		570140	154,61		
				M 35		570150	154,61		
				M 42 (PR-3S)	Z2	572706 R	672,57		
				M 54 (PR-3S)	Z2	572708 R	672,57		
				M 76,1 XL (PR-3S)	Z6 XL <sup>3)</sup> / Z7 XL 45 kN <sup>4)</sup>	579101 R	1.161,47		
				M 88,9 G XL (PR-3S)	Z6 XL <sup>3)</sup> / Z7 XL 45 kN <sup>4)</sup>	579110 R	1.355,58		
				M 108,0 G XL (PR-3S)	Z6 XL <sup>3)</sup> / Z7 XL 45 kN <sup>4)</sup>	579111 R	1.355,58		
				M 15 S (PR-2B)	Z8	574738 R	124,51		
				M 18 S (PR-2B)	Z8	574740 R	124,51		
				M 22 S (PR-2B)	Z8	574742 R	124,51		
				M 28 S (PR-2B)	Z8	574744 R	124,51		
				M 35 S (PR-2B)	Z8	574746 R	136,96		
				AIRBEL PRESSCLIM	M 15	570110	154,61		
				M 18		570120	154,61		
				M 22		570130	154,61		
				M 28		570140	154,61		
				M 35		570150	154,61		
				M 42 (PR-3S)	Z2	572706 R	672,57		
				M 54 (PR-3S)	Z2	572708 R	672,57		
				M 76,1 XL (PR-3S)	Z6 XL <sup>3)</sup> / Z7 XL 45 kN <sup>4)</sup>	579101 R	1.161,47		
				M 88,9 G XL (PR-3S)	Z6 XL <sup>3)</sup> / Z7 XL 45 kN <sup>4)</sup>	579110 R	1.355,58		
				M 108,0 G XL (PR-3S)	Z6 XL <sup>3)</sup> / Z7 XL 45 kN <sup>4)</sup>	579111 R	1.355,58		
				M 15 S (PR-2B)	Z8	574738 R	124,51		
				M 18 S (PR-2B)	Z8	574740 R	124,51		
				M 22 S (PR-2B)	Z8	574742 R	124,51		
				M 28 S (PR-2B)	Z8	574744 R	124,51		
				M 35 S (PR-2B)	Z8	574746 R	136,96		

Pressfitting systems for gas installations must only be pressed with pressing tongs/pressing rings which are highlighted in yellow.

Observe the national regulations. Read and observe the instructions for use and the installation instructions of the system provider/manufacturer.

\* Can also be driven by the REMS Eco-Press manual radial press, see page 185. Observe the national regulations.

\*\* Can also be driven by the REMS Eco-Press manual radial press using the Z8 adapter tongs, see page 185. Observe the national regulations.

1) Only pressing tongs from designation "108" (1<sup>st</sup> quarter of 2008), "208" (2<sup>nd</sup> quarter of 2008) etc. can be used. The designation is stamped on every pressing jaw.

2) For this pressfitting system producing a pressing joint with manual radial presses is not permitted.

3) Driven by REMS Power-Press XL ACC, see page 188.

4) Driven by REMS Akku-Press XL 45 kN 22V ACC, see page 196.

5) For taking suitable pressing inserts.

6) Press fittings made of red bronze (Sanpress XL) must be pressed with pressing rings with press contour VR, copper fittings (Profipress XL, Profipress G XL), carbon steel (Prestabo XL) and stainless steel fittings (Sanpress Inox XL, Sanpress Inox G XL) with pressing rings with press contour VF.

7) Use pressing rings labelled "M 88.9 G" or "M 108 G" on the three pressing segments for gas installations.

8) For making press joints for operating pressure ≤ PN 10.

9) For pipes of the EN technical standard. Observe the instructions for use of the system provider/manufacturer.

10) For pipes of the ASTM technical standard. Observe the instructions for use of the system provider/manufacturer.

11) Only use pressing tongs identified by "VMP ½" G" on the pressing jaws for gas installations.

12) Previous designation: C 26 pressing tongs

The suitability of REMS pressing tools for pressfitting systems: Date 27.10.2023. For the updated situation regarding suitability status check our website:

www.rems.de > Downloads > Product catalogues, brochures > REMS Catalogue.

See page 238 for adapter tongs. Pressing tongs/pressing rings for additional pressfitting systems on request.

# REMS pressing tongs

# REMS pressing rings

Accessories for REMS radial presses (except for REMS Mini-Press) and suitable radial presses of other makes

System	Pressing tongs / pressing rings	Driven by adapter tongs	Art.-No.	€
AIRBEL	M 15		570110	154,61
SERTINOX	M 18		570120	154,61
	M 22		570130	154,61
	M 28		570140	154,61
	M 35		570150	154,61
	M 42 (PR-3S)	Z2	572706 R	672,57
	M 54 (PR-3S)	Z2	572708 R	672,57
	M 76,1 XL (PR-3S)	Z6 XL <sup>3)</sup> / Z7 XL 45 kN <sup>4)</sup>	579101 R	1.161,47
	M 88,9 G XL (PR-3S)	Z6 XL <sup>3)</sup> / Z7 XL 45 kN <sup>4)</sup>	579110 R	1.355,58
	M 108,0 G XL (PR-3S)	Z6 XL <sup>3)</sup> / Z7 XL 45 kN <sup>4)</sup>	579111 R	1.355,58
	M 15 S (PR-2B)	Z8	574738 R	124,51
	M 18 S (PR-2B)	Z8	574740 R	124,51
	M 22 S (PR-2B)	Z8	574742 R	124,51
	M 28 S (PR-2B)	Z8	574744 R	124,51
	M 35 S (PR-2B)	Z8	574746 R	136,96
ALB	TH 16*		570460	186,32
Sistema Multicapa para calefacción y sanitario	TH 18*		570465	186,32
	TH 20*		570470	186,32
	TH 26*		570475	186,32
	TH 32		570480	186,32
	TH 40		570485	246,99
	TH 50 (PZ-S)		572400	645,58
	TH 63 (PZ-S)		572405	645,58
	TH 16 S (PR-2B)**	Z8	574782 R	124,51
	TH 18 S (PR-2B)**	Z8	574786 R	124,51
	TH 20 S (PR-2B)**	Z8	574788 R	124,51
	TH 26 S (PR-2B)**	Z8	574794 R	124,51
	TH 32 S (PR-2B)	Z8	574798 R	136,96
	H 16*		570320	168,10
	H 18*		570340	168,10
	H 20*		570350	168,10
	H 26*		570370	168,10
	H 32		570380	168,10
	H 40 (PZ-4G)		570390	565,67
	U 16*		570765	174,33
	U 18*		570770	174,33
	U 20*		570775	174,33
	U 26* <sup>12)</sup>		570750	204,43
	U 32		570785	204,43
	U 40		570790	249,07
ALB	TH 16*		570460	186,32
Sistema Multicapa para Gas	TH 20*		570470	186,32
	TH 26*		570475	186,32
	TH 32		570480	186,32
	TH 16 S (PR-2B)**	Z8	574782 R	124,51
	TH 20 S (PR-2B)**	Z8	574788 R	124,51
	TH 26 S (PR-2B)**	Z8	574794 R	124,51
	TH 32 S (PR-2B)	Z8	574798 R	136,96
	H 16*		570320	168,10
	H 20*		570350	168,10
	H 26*		570370	168,10
	H 32		570380	168,10
	U 16*		570765	174,33
	U 20*		570775	174,33
	U 26* <sup>12)</sup>		570750	204,43
	U 32		570785	204,43
ALTECH Altech	Rfz 12*		571320	194,05
	Rfz 16*		571325	194,05
	Rfz 20*		571330	194,05
	Rfz 25		571335	194,05
APE MULTYGAS Serie AP Gas	TH 16*		570460	186,32
	TH 20*		570470	186,32
	TH 26*		570475	186,32
	TH 32		570480	186,32
	TH 16 S (PR-2B)**	Z8	574782 R	124,51
	TH 20 S (PR-2B)**	Z8	574788 R	124,51
	TH 26 S (PR-2B)**	Z8	574794 R	124,51
	TH 32 S (PR-2B)	Z8	574798 R	136,96
APE Serie AP	B 16*		570850	203,40
	B 20*		570860	203,40
	B 26		570870	224,16
	B 32		570880	224,16
	H 16*		570320	168,10
	H 20*		570350	168,10
	H 26*		570370	168,10
	H 32		570380	168,10
	TH 16*		570460	186,32
	TH 18*		570465	186,32
	TH 20*		570470	186,32
	TH 26*		570475	186,32
	TH 32		570480	186,32
	TH 16 S (PR-2B)**	Z8	574782 R	124,51
	TH 18 S (PR-2B)**	Z8	574786 R	124,51
	TH 20 S (PR-2B)**	Z8	574788 R	124,51
	TH 26 S (PR-2B)**	Z8	574794 R	124,51
	TH 32 S (PR-2B)	Z8	574798 R	136,96
	U 16*		570765	174,33
	U 20*		570775	174,33

System	Pressing tongs / pressing rings	Driven by adapter tongs	Art.-No.	€
APE Serie APL	H 16*		570320	168,10
	H 18*		570340	168,10
	H 20*		570350	168,10
	H 25*		570360	168,10
	H 26*		570370	168,10
	H 32		570380	168,10
	TH 16*		570460	186,32
	TH 18*		570465	186,32
	TH 20*		570470	186,32
	TH 25*		570495	186,32
	TH 26*		570475	186,32
	TH 32		570480	186,32
	TH 16 S (PR-2B)**	Z8	574782 R	124,51
	TH 18 S (PR-2B)**	Z8	574786 R	124,51
	TH 20 S (PR-2B)**	Z8	574788 R	124,51
	TH 25 S (PR-2B)**	Z8	574792 R	124,51
	TH 26 S (PR-2B)**	Z8	574794 R	124,51
	TH 32 S (PR-2B)	Z8	574798 R	136,96
	U 16*		570765	174,33
	U 18*		570770	174,33
	U 20*		570775	174,33
AQUATECHNIK Press-fitting metal	H 16*		570320	168,10
	H 20*		570350	168,10
	H 26*		570370	168,10
	H 32		570380	168,10
	TH 16*		570460	186,32
	TH 20*		570470	186,32
	TH 26*		570475	186,32
	TH 32		570480	186,32
	TH 40		570485	246,99
	TH 50 (PZ-S)		572400	645,58
	TH 63 (PZ-S)		572405	645,58
	TH 16 S (PR-2B)**	Z8	574782 R	124,51
	TH 20 S (PR-2B)**	Z8	574788 R	124,51
	TH 26 S (PR-2B)**	Z8	574794 R	124,51
	TH 32 S (PR-2B)	Z8	574798 R	136,96
	U 16*		570765	174,33
	U 20*		570775	174,33
	U 26* <sup>12)</sup>		570750	204,43
	U 32		570785	204,43
AQUATECHNIK Universal	B 16*		570850	203,40
	B 20*		570860	203,40
	B 26		570870	224,16
	B 32		570880	224,16
	F 16*		570717	177,45
	F 20*		570727	177,45
	F 26*		570730	191,98
	F 32		570735	191,98
	F 16 S (PR-2B)**	Z8	574728 R	124,51
	F 20 S (PR-2B)**	Z8	574730 R	124,51
	F 26 S (PR-2B)**	Z8	574732 R	124,51
	F 32 S (PR-2B)	Z8	574734 R	136,96
	H 16*		570320	168,10
	H 20*		570350	168,10
	H 26*		570370	168,10
	H 32		570380	168,10
	TH 16*		570460	186,32
	TH 20*		570470	186,32
	TH 26*		570475	186,32
	TH 32		570480	186,32
	TH 16 S (PR-2B)**	Z8	574782 R	124,51
	TH 20 S (PR-2B)**	Z8	574788 R	124,51
	TH 26 S (PR-2B)**	Z8	574794 R	124,51
	TH 32 S (PR-2B)	Z8	574798 R	136,96
	U 16*		570765	174,33
	U 20*		570775	174,33
	U 26* <sup>12)</sup>		570750	204,43
	U 32		570785	204,43
ARKA DUROsystem	H 16*		570320	168,10
	H 20*		570350	168,10
	H 25*		570360	168,10
	H 26*		570370	168,10
	H 32		570380	168,10
	TH 16*		570460	186,32
	TH 20*		570470	186,32
	TH 25*		570495	186,32
	TH 26*		570475	186,32
	TH 32		570480	186,32
	TH 16 S (PR-2B)**	Z8	574782 R	124,51
	TH 20 S (PR-2B)**	Z8	574788 R	124,51
	TH 25 S (PR-2B)**	Z8	574792 R	124,51
	TH 26 S (PR-2B)**	Z8	574794 R	124,51
	TH 32 S (PR-2B)	Z8	574798 R	136,96
	U 16*		570765	174,33
	U 20*		570775	174,33
Aschl NIR	M 15		570110	154,61
	M 18		570120	154,61
	M 22		570130	154,61
	M 28		570140	154,61
	M 35		570150	154,61
	M 42 (PR-3S)	Z2	572706 R	672,57
	M 54 (PR-3S)	Z2	572708 R	672,57
	M 76,1 XL (PR-3S)	Z6 XL <sup>3)</sup> / Z7 XL 45 kN <sup>4)</sup>	579101 R	1.161,47
	M 88,9 G XL (PR-3S)	Z6 XL <sup>3)</sup> / Z7 XL 45 kN <sup>4)</sup>	579110 R	1.355,58
	M 108,0 G XL (PR-3S)	Z6 XL <sup>3)</sup> / Z7 XL 45 kN <sup>4)</sup>	579111 R	1.355,58
	M 15 S (PR-2B)	Z8	574738 R	124,51
	M 18 S (PR-2B)	Z8	574740 R	124,51
	M 22 S (PR-2B)	Z8	574742 R	124,51
	M 28 S (PR-2B)	Z8	574744 R	124,51
	M 35 S (PR-2B)	Z8	574746 R	136,96





System	Pressing tongs / pressing rings	Driven by adapter tongs	Art.-No.	€
BRASSTECH MULTitermoSAN Brasspress	B 16*		570850	203,40
	B 20*		570860	203,40
	B 26		570870	224,16
	B 32		570880	224,16
	F 16*		570717	177,45
	F 20*		570727	177,45
	F 26*		570730	191,98
	F 16 S (PR-2B)**	Z8	574728 R	124,51
	F 20 S (PR-2B)**	Z8	574730 R	124,51
	F 26 S (PR-2B)**	Z8	574732 R	124,51
	H 16*		570320	168,10
	H 18*		570340	168,10
	H 20*		570350	168,10
	H 26*		570370	168,10
	TH 16*		570460	186,32
	TH 18*		570465	186,32
	TH 20*		570470	186,32
	TH 26*		570475	186,32
	TH 32		570480	186,32
	TH 40		570485	246,99
	TH 50 (PZ-S)		572400	645,58
	TH 63 (PZ-S)		572405	645,58
	TH 16 S (PR-2B)**	Z8	574782 R	124,51
	TH 18 S (PR-2B)**	Z8	574786 R	124,51
	TH 20 S (PR-2B)**	Z8	574788 R	124,51
	TH 26 S (PR-2B)**	Z8	574794 R	124,51
	TH 32 S (PR-2B)	Z8	574798 R	136,96
	U 16*		570765	174,33
	U 18*		570770	174,33
	U 20*		570775	174,33
	U 26* <sup>12)</sup>		570750	204,43
	U 32		570785	204,43

**C**

Cello Products -B- Press	VUS ½" (OD 15,9 mm)		571770	186,79
	VUS ¾" (OD 22,2 mm)		571775	186,79
	VUS 1" (OD 28,6 mm)		571780	186,79
	VUS 1¼" (OD 34,9 mm)		571785	186,79
	VUS 1½" (OD 41,3 mm)		571790	360,13
CGR DYNAFLU multicouche	VUS 2" (OD 54,0 mm)		571795	370,51
	H 16*		570320	168,10
	H 20*		570350	168,10
	H 26*		570370	168,10
	H 32		570380	168,10
	TH 16*		570460	186,32
	TH 20*		570470	186,32
	TH 26*		570475	186,32
	TH 32		570480	186,32
	TH 40		570485	246,99
	TH 50 (PZ-S)		572400	645,58
	TH 63 (PZ-S)		572405	645,58
	TH 16 S (PR-2B)**	Z8	574782 R	124,51
	TH 20 S (PR-2B)**	Z8	574788 R	124,51
	TH 26 S (PR-2B)**	Z8	574794 R	124,51
	TH 32 S (PR-2B)	Z8	574798 R	136,96
	U 16*		570765	174,33
	U 20*		570775	174,33
	U 26* <sup>12)</sup>		570750	204,43
	U 32		570785	204,43
	U 40		570790	249,07
	U 50		570795	298,89
U 63 (PR-3B)	Z4	572837 R	733,81	
U 63 (PZ-S)		572365	645,58	
CGR DYNAFLU PER	H 12*		570300	168,10
	H 16*		570320	168,10
	H 20*		570350	168,10
	H 25*		570360	168,10
	RFz 12*		571320	194,05
	RFz 16*		571325	194,05
	RFz 20*		571330	194,05
	RFz 25		571335	194,05

System	Pressing tongs / pressing rings	Driven by adapter tongs	Art.-No.	€	
CHIALI CHIALIPEX	TH 16*		570460	186,32	
	TH 20*		570470	186,32	
	TH 26*		570475	186,32	
	TH 32		570480	186,32	
	TH 40		570485	246,99	
	TH 50 (PZ-S)		572400	645,58	
	TH 63 (PZ-S)		572405	645,58	
	Climatrix Climatrix Rhinopex	H 16*		570320	168,10
		H 20*		570350	168,10
		U 16*		570765	174,33
		U 20*		570775	174,33
		U 26* <sup>12)</sup>		570750	204,43
	TH 14*		570455	186,32	
	TH 16*		570460	186,32	
	TH 18*		570465	186,32	
TH 20*		570470	186,32		
TH 26*		570475	186,32		
TH 32		570480	186,32		
TH 16 S (PR-2B)**	Z8	574782 R	124,51		
TH 20 S (PR-2B)**	Z8	574788 R	124,51		
TH 26 S (PR-2B)**	Z8	574794 R	124,51		
TH 32 S (PR-2B)	Z8	574798 R	136,96		
Climatrix Variotherm	TH 11,6*		570482	186,32	
	TH 16*		570460	186,32	
System TH ClouSet	TH 16 S (PR-2B)**	Z8	574782 R	124,51	
	TH 16*		570460	186,32	
	TH 18*		570465	186,32	
	TH 20*		570470	186,32	
	TH 16 S (PR-2B)**	Z8	574782 R	124,51	
	TH 18 S (PR-2B)**	Z8	574786 R	124,51	
	TH 20 S (PR-2B)**	Z8	574788 R	124,51	
Comap PEX Press	RFz 12*		571320	194,05	
	RFz 16*		571325	194,05	
	RFz 20*		571330	194,05	
	RFz 25		571335	194,05	
	Comap Multiskin	TH 14*		570455	186,32
TH 16*			570460	186,32	
TH 18*			570465	186,32	
TH 20*			570470	186,32	
TH 26*			570475	186,32	
TH 32			570480	186,32	
THL 32			570487	186,32	
TH 40			570485	246,99	
TH 50 (PZ-S)			572400	645,58	
TH 63 (PZ-S)			572405	645,58	
THz 75 (PR-3B)		Z4	572829 R	609,25	
TH 16 S (PR-2B)**		Z8	574782 R	124,51	
TH 20 S (PR-2B)**		Z8	574788 R	124,51	
TH 26 S (PR-2B)**		Z8	574794 R	124,51	
TH 32 S (PR-2B)		Z8	574798 R	136,96	
U 14*			570760	174,33	
U 16*			570765	174,33	
U 18*			570770	174,33	
U 20*			570775	174,33	
U 32			570785	204,43	
U 40		570790	249,07		
U 50		570795	298,89		
U 63 (PR-3B)	Z4	572837 R	733,81		
U 63 (PZ-S)		572365	645,58		
U 75 (PR-3B)	Z4	572828 R	645,58		
H 14*		570310	168,10		
H 16*		570320	168,10		
H 18*		570340	168,10		
H 20*		570350	168,10		
H 26*		570370	168,10		
H 32		570380	168,10		
H 40 (PZ-4G)		570390	565,67		

Pressfitting systems for gas installations must only be pressed with pressing tongs/pressing rings which are highlighted in yellow.

Observe the national regulations. Read and observe the instructions for use and the installation instructions of the system provider/manufacturer.

\* Can also be driven by the REMS Eco-Press manual radial press, see page 185. Observe the national regulations.

\*\* Can also be driven by the REMS Eco-Press manual radial press using the Z8 adapter tongs, see page 185. Observe the national regulations.

<sup>1)</sup> Only pressing tongs from designation "108" (1<sup>st</sup> quarter of 2008), "208" (2<sup>nd</sup> quarter of 2008) etc. can be used. The designation is stamped on every pressing jaw.

<sup>2)</sup> For this pressfitting system producing a pressing joint with manual radial presses is not permitted.

<sup>3)</sup> Driven by REMS Power-Press XL ACC, see page 188.

<sup>4)</sup> Driven by REMS Akku-Press XL 45 kN 22V ACC, see page 196.

<sup>5)</sup> For taking suitable pressing inserts.

<sup>6)</sup> Press fittings made of red bronze (Sanpress XL) must be pressed with pressing rings with press contour VR, copper fittings (Profipress XL, Profipress G XL), carbon steel (Prestabo XL) and stainless steel fittings (Sanpress Inox XL, Sanpress Inox G XL) with pressing rings with press contour VF.

<sup>7)</sup> Use pressing rings labelled "M 88.9 G" or "M 108 G" on the three pressing segments for gas installations.

<sup>8)</sup> For making press joints for operating pressure ≤ PN 10.

<sup>9)</sup> For pipes of the EN technical standard. Observe the instructions for use of the system provider/manufacturer.

<sup>10)</sup> For pipes of the ASTM technical standard. Observe the instructions for use of the system provider/manufacturer.

<sup>11)</sup> Only use pressing tongs identified by "VMP ½" G" on the pressing jaws for gas installations.

<sup>12)</sup> Previous designation: C 26 pressing tongs

The suitability of REMS pressing tools for pressfitting systems: Date 27.10.2023. For the updated situation regarding suitability status check our website: [www.rems.de](http://www.rems.de) > Downloads > Product catalogues, brochures > REMS Catalogue.

See page 238 for adapter tongs. Pressing tongs/pressing rings for additional pressfitting systems on request.



# REMS pressing tongs REMS pressing rings

Accessories for REMS radial presses (except for REMS Mini-Press)  
and suitable radial presses of other makes

System	Pressing tongs/ pressing rings	Driven by adapter tongs	Art.-No.	€	System	Pressing tongs/ pressing rings	Driven by adapter tongs	Art.-No.	€	
Conex Bänninger >B< Press	V 12		570107	154,61	Conex Bänninger >B< Press XL stainless	XP 64,0 XL (PR-3S)	Z6 XL <sup>3)</sup> / Z7 XL 45 kN <sup>4)</sup>	579100 R	1.056,63	
	V 14		570112	154,61		XP 66,7 XL (PR-3S)	Z6 XL <sup>3)</sup> / Z7 XL 45 kN <sup>4)</sup>	579108 R	1.161,47	
	V 15		570115	154,61		M 76,1 XL (PR-3S)	Z6 XL <sup>3)</sup> / Z7 XL 45 kN <sup>4)</sup>	579101 R	1.161,47	
	V 16		570117	154,61		CBM 88,9 XL (PR-3S)	Z6 XL <sup>3)</sup> / Z7 XL 45 kN <sup>4)</sup>	579144 R	1.355,58	
	V 18		570125	154,61		CBM 108,0 XL (PR-3S)	Z6 XL <sup>3)</sup> / Z7 XL 45 kN <sup>4)</sup>	579146 R	1.355,58	
	V 22		570135	154,61		Conex Bänninger >B< Press Solar	V 12		570107	154,61
	V 28		570145	154,61			V 14		570112	154,61
	V 35		570155	154,61			V 15		570115	154,61
	V 42		570165	360,13			V 16		570117	154,61
	V 54		570175	370,51			V 18		570125	154,61
	V 12 S (PR-2B)	Z8	574748 R	124,51			V 22		570135	154,61
	V 14 S (PR-2B)	Z8	574800 R	124,51			V 28		570145	154,61
	V 15 S (PR-2B)	Z8	574752 R	124,51			V 35		570155	154,61
	V 16 S (PR-2B)	Z8	574802 R	124,51	V 42			570165	360,13	
	V 18 S (PR-2B)	Z8	574756 R	124,51	V 54			570175	370,51	
	V 22 S (PR-2B)	Z8	574758 R	124,51	V 12 S (PR-2B)	Z8	574748 R	124,51		
	V 28 S (PR-2B)	Z8	574760 R	124,51	V 14 S (PR-2B)	Z8	574800 R	124,51		
	V 35 S (PR-2B)	Z8	574762 R	136,96	V 15 S (PR-2B)	Z8	574752 R	124,51		
	M 15		570110	154,61	V 16 S (PR-2B)	Z8	574802 R	124,51		
	M 22		570130	154,61	V 18 S (PR-2B)	Z8	574756 R	124,51		
	M 28		570140	154,61	V 22 S (PR-2B)	Z8	574758 R	124,51		
	Conex Bänninger >B< Press XL copper	VFz 64,0 (PR-3B)	Z5	572815 R	609,25	V 28 S (PR-2B)	Z8	574760 R	124,51	
		CBVFz 66,7 (PR-3B)	Z5	572847 R	609,25	V 35 S (PR-2B)	Z8	574762 R	136,96	
VFz 76,1 (PR-3B) <sup>5)</sup>		Z5	572816 R	609,25	<b>D</b>					
VFz 88,9 (PR-3B) <sup>6)</sup>		Z5	572817 R	645,58	Debrunner Acifer	M 12		570100	154,61	
VFz 108,0 (PR-3B) <sup>6)</sup>		Z5	572818 R	645,58	d-a Presssystem	M 15		570110	154,61	
Conex Bänninger >B< Press carbon	V 15		570115	154,61	C-Stahl	M 18		570120	154,61	
	V 18		570125	154,61		M 22		570130	154,61	
	V 22		570135	154,61		M 28		570140	154,61	
	V 28		570145	154,61		M 35		570150	154,61	
	V 35		570155	154,61	M 42 (PR-3S)	Z2	572706 R	672,57		
	V 42		570165	360,13	M 54 (PR-3S)	Z2	572708 R	672,57		
	V 42 (PR-2B)	Z2	572850 R	322,77	M 76,1 XL (PR-3S)	Z6 XL <sup>3)</sup> / Z7 XL 45 kN <sup>4)</sup>	579101 R	1.161,47		
	V 54		570175	370,51	M 88,9 G XL (PR-3S)	Z6 XL <sup>3)</sup> / Z7 XL 45 kN <sup>4)</sup>	579110 R	1.355,58		
	V 54 (PR-2B)	Z2	572851 R	348,72	M 108,0 G XL (PR-3S)	Z6 XL <sup>3)</sup> / Z7 XL 45 kN <sup>4)</sup>	579111 R	1.355,58		
	V 15 S (PR-2B)	Z8	574752 R	124,51	M 12 S (PR-2B)	Z8	574736 R	124,51		
	V 18 S (PR-2B)	Z8	574756 R	124,51	M 15 S (PR-2B)	Z8	574738 R	124,51		
	V 22 S (PR-2B)	Z8	574758 R	124,51	M 18 S (PR-2B)	Z8	574740 R	124,51		
	V 28 S (PR-2B)	Z8	574760 R	124,51	M 22 S (PR-2B)	Z8	574742 R	124,51		
	V 35 S (PR-2B)	Z8	574762 R	136,96	M 28 S (PR-2B)	Z8	574744 R	124,51		
	Conex Bänninger >B< Press XL carbon	XP 64,0 XL (PR-3S)	Z6 XL <sup>3)</sup> / Z7 XL 45 kN <sup>4)</sup>	579100 R	1.056,63	M 35 S (PR-2B)	Z8	574746 R	136,96	
XP 66,7 XL (PR-3S)		Z6 XL <sup>3)</sup> / Z7 XL 45 kN <sup>4)</sup>	579108 R	1.161,47	<b>E</b>					
M 76,1 XL (PR-3S)		Z6 XL <sup>3)</sup> / Z7 XL 45 kN <sup>4)</sup>	579101 R	1.161,47	DUOPIPE SYSTEMS	U 16*		570765	174,33	
CBM 88,9 XL (PR-3S)		Z6 XL <sup>3)</sup> / Z7 XL 45 kN <sup>4)</sup>	579144 R	1.355,58	DUOFIL MKSYSTEM	U 18*		570770	174,33	
CBM 108,0 XL (PR-3S)		Z6 XL <sup>3)</sup> / Z7 XL 45 kN <sup>4)</sup>	579146 R	1.355,58		U 20*		570775	174,33	
Conex Bänninger >B< Press Gas	V 12		570107	154,61		U 25*		570780	174,33	
	V 14		570112	154,61		U 32		570785	204,43	
	V 15		570115	154,61	DW Verbundrohr	U 16*		570765	174,33	
	V 16		570117	154,61	multitubo systems	U 18*		570770	174,33	
	V 18		570125	154,61		U 20*		570775	174,33	
	V 22		570135	154,61		U 25*		570780	174,33	
	V 28		570145	154,61		U 32		570785	204,43	
	V 35		570155	154,61		U 40		570790	249,07	
	V 42		570165	360,13		U 50		570795	298,89	
	V 54		570175	370,51		U 63 (PR-3B)	Z4	572837 R	733,81	
	V 12 S (PR-2B)	Z8	574748 R	124,51		U 63 (PZ-S)		572365	645,58	
	V 14 S (PR-2B)	Z8	574800 R	124,51		U 75 (PR-3B)	Z4	572828 R	645,58	
	V 15 S (PR-2B)	Z8	574752 R	124,51	<b>E</b>					
	V 16 S (PR-2B)	Z8	574802 R	124,51	EBRILLE	U 16*		570765	174,33	
	V 18 S (PR-2B)	Z8	574756 R	124,51	Isomonflex	U 20*		570775	174,33	
V 22 S (PR-2B)	Z8	574758 R	124,51		U 25*		570780	174,33		
V 28 S (PR-2B)	Z8	574760 R	124,51		H 26*		570370	168,10		
V 35 S (PR-2B)	Z8	574762 R	136,96		TH 26*		570475	186,32		
					TH 26 S (PR-2B)**	Z8	574794 R	124,51		
					U 32		570785	204,43		
Conex Bänninger >B< Press Inox	V 15		570115	154,61	EBRILLE	U 16*		570765	174,33	
	V 18		570125	154,61	Monflex	U 20*		570775	174,33	
	V 22		570135	154,61		U 25*		570780	174,33	
	V 28		570145	154,61		H 26*		570370	168,10	
	V 35		570155	154,61		TH 26*		570475	186,32	
	V 42		570165	360,13		TH 26 S (PR-2B)**	Z8	574794 R	124,51	
	V 42 (PR-2B)	Z2	572850 R	322,77		U 32		570785	204,43	
	V 54		570175	370,51		U 16*		570765	174,33	
	V 54 (PR-2B)	Z2	572851 R	348,72		U 20*		570775	174,33	
	V 15 S (PR-2B)	Z8	574752 R	124,51		U 25*		570780	174,33	
	V 18 S (PR-2B)	Z8	574756 R	124,51		H 26*		570370	168,10	
	V 22 S (PR-2B)	Z8	574758 R	124,51		TH 26*		570475	186,32	
	V 28 S (PR-2B)	Z8	574760 R	124,51		TH 26 S (PR-2B)**	Z8	574794 R	124,51	
	V 35 S (PR-2B)	Z8	574762 R	136,96		U 32		570785	204,43	

Pressfitting systems for gas installations must only be pressed with pressing tongs/pressing rings which are highlighted in yellow.

Observe the national regulations. Read and observe the instructions for use and the installation instructions of the system provider/manufacturer.

\* Can also be driven by the REMS Eco-Press manual radial press, see page 185. Observe the national regulations.

\*\* Can also be driven by the REMS Eco-Press manual radial press using the Z8 adapter tongs, see page 185. Observe the national regulations.

<sup>1)</sup> Only pressing tongs from designation "108" (1<sup>st</sup> quarter of 2008), "208" (2<sup>nd</sup> quarter of 2008) etc. can be used. The designation is stamped on every pressing jaw.

<sup>2)</sup> For this pressfitting system producing a pressing joint with manual radial presses is not permitted.

<sup>3)</sup> Driven by REMS Power-Press XL ACC, see page 188.

<sup>4)</sup> Driven by REMS Akku-Press XL 45 kN 22V ACC, see page 196.

<sup>5)</sup> For taking suitable pressing inserts.

<sup>6)</sup> Press fittings made of red bronze (Sanpress XL) must be pressed with pressing rings with press contour VR, copper fittings (Profipress XL, Profipress G XL), carbon steel (Prestabo XL) and stainless steel fittings (Sanpress Inox XL, Sanpress Inox G XL) with pressing rings with press contour VF.

<sup>7)</sup> Use pressing rings labelled "M 88,9 G" or "M 108 G" on the three pressing segments for gas installations.

<sup>8)</sup> For making press joints for operating pressure ≤ PN 10.

<sup>9)</sup> For pipes of the EN technical standard. Observe the instructions for use of the system provider/manufacturer.

<sup>10)</sup> For pipes of the ASTM technical standard. Observe the instructions for use of the system provider/manufacturer.

<sup>11)</sup> Only use pressing tongs identified by "VMP ½" G" on the pressing jaws for gas installations.

<sup>12)</sup> Previous designation: C 26 pressing tongs

The suitability of REMS pressing tools for pressfitting systems: Date 27.10.2023. For the updated situation regarding suitability status check our website: [www.rems.de](http://www.rems.de) > Downloads > Product catalogues, brochures > REMS Catalogue.

See page 238 for adapter tongs. Pressing tongs/pressing rings for additional pressfitting systems on request.

# REMS pressing tongs

## REMS pressing rings

Accessories for REMS radial presses (except for REMS Mini-Press) and suitable radial presses of other makes

System	Pressing tongs / pressing rings	Driven by adapter tongs	Art.-No.	€
EFFEBI	M 15		570110	154,61
EFFEBI-PRESS	M 18		570120	154,61
Aisi316	M 22		570130	154,61
System M Profile <sup>1)</sup>	M 28		570140	154,61
	M 35		570150	154,61
	M 42 (PR-3S)	Z2	572706 R	672,57
	M 54 (PR-3S)	Z2	572708 R	672,57
	M 76,1 XL (PR-3S)	Z6 XL <sup>3)</sup> / Z7 XL 45 kN <sup>4)</sup>	579101 R	1.161,47
	M 88,9 G XL (PR-3S)	Z6 XL <sup>3)</sup> / Z7 XL 45 kN <sup>4)</sup>	579110 R	1.355,58
	M 108,0 G XL (PR-3S) <sup>5)</sup>	Z6 XL <sup>3)</sup> / Z7 XL 45 kN <sup>4)</sup>	579111 R	1.355,58
	M 15 S (PR-2B)	Z8	574738 R	124,51
	M 18 S (PR-2B)	Z8	574740 R	124,51
	M 22 S (PR-2B)	Z8	574742 R	124,51
	M 28 S (PR-2B)	Z8	574744 R	124,51
	M 35 S (PR-2B)	Z8	574746 R	136,96
	EFFEBI	V 12		570107
EFFEBI-PRESS	V 15		570115	154,61
Aisi316	V 18		570125	154,61
System V Profile	V 22		570135	154,61
	V 28		570145	154,61
	V 35		570155	154,61
	V 42		570165	360,13
	V 42 (PR-2B)	Z2	572850 R	322,77
	V 54		570175	370,51
	V 54 (PR-2B)	Z2	572851 R	348,72
	V 12 S (PR-2B)	Z8	574748 R	124,51
	V 15 S (PR-2B)	Z8	574752 R	124,51
	V 18 S (PR-2B)	Z8	574756 R	124,51
	V 22 S (PR-2B)	Z8	574758 R	124,51
	V 28 S (PR-2B)	Z8	574760 R	124,51
	V 35 S (PR-2B)	Z8	574762 R	136,96
EFFEBI	M 12		570100	154,61
EFFEBI-PRESS	M 15		570110	154,61
Carbon-S	M 18		570120	154,61
System M Profile <sup>1)</sup>	M 22		570130	154,61
	M 28		570140	154,61
	M 35		570150	154,61
	M 42 (PR-3S)	Z2	572706 R	672,57
	M 54 (PR-3S)	Z2	572708 R	672,57
	M 76,1 XL (PR-3S)	Z6 XL <sup>3)</sup> / Z7 XL 45 kN <sup>4)</sup>	579101 R	1.161,47
	M 88,9 G XL (PR-3S)	Z6 XL <sup>3)</sup> / Z7 XL 45 kN <sup>4)</sup>	579110 R	1.355,58
	M 108,0 G XL (PR-3S)	Z6 XL <sup>3)</sup> / Z7 XL 45 kN <sup>4)</sup>	579111 R	1.355,58
	M 12 S (PR-2B)	Z8	574736 R	124,51
	M 15 S (PR-2B)	Z8	574738 R	124,51
	M 18 S (PR-2B)	Z8	574740 R	124,51
	M 22 S (PR-2B)	Z8	574742 R	124,51
	M 28 S (PR-2B)	Z8	574744 R	124,51
M 35 S (PR-2B)	Z8	574746 R	136,96	
EFFEBI	V 12		570107	154,61
EFFEBI-PRESS	V 15		570115	154,61
Carbon-S	V 18		570125	154,61
System V Profile	V 22		570135	154,61
	V 28		570145	154,61
	V 35		570155	154,61
	V 42		570165	360,13
	V 42 (PR-2B)	Z2	572850 R	322,77
	V 54		570175	370,51
	V 54 (PR-2B)	Z2	572851 R	348,72
	V 12 S (PR-2B)	Z8	574748 R	124,51
	V 15 S (PR-2B)	Z8	574752 R	124,51
	V 18 S (PR-2B)	Z8	574756 R	124,51
	V 22 S (PR-2B)	Z8	574758 R	124,51
	V 28 S (PR-2B)	Z8	574760 R	124,51
	V 35 S (PR-2B)	Z8	574762 R	136,96
EFFEBI	V 12		570107	154,61
EFFEBI-PRESS	V 14		570112	154,61
COPPER	V 15		570115	154,61
	V 16		570117	154,61
	V 18		570125	154,61
	V 22		570135	154,61
	V 28		570145	154,61
	V 35		570155	154,61
	V 42		570165	360,13
	V 42 (PR-2B)	Z2	572850 R	322,77
	V 54		570175	370,51
	V 54 (PR-2B)	Z2	572851 R	348,72
	V 12 S (PR-2B)	Z8	574748 R	124,51
	V 14 S (PR-2B)	Z8	574800 R	124,51
	V 15 S (PR-2B)	Z8	574752 R	124,51
V 16 S (PR-2B)	Z8	574802 R	124,51	
V 18 S (PR-2B)	Z8	574756 R	124,51	
V 22 S (PR-2B)	Z8	574758 R	124,51	
V 28 S (PR-2B)	Z8	574760 R	124,51	
V 35 S (PR-2B)	Z8	574762 R	136,96	
EFFEBI	V 12		570107	154,61
EFFEBI-PRESS	V 15		570115	154,61
UNICO	V 18		570125	154,61
	V 22		570135	154,61
	V 28		570145	154,61
	V 35		570155	154,61
	V 42		570165	360,13
	V 42 (PR-2B)	Z2	572850 R	322,77
	V 54		570175	370,51
	V 54 (PR-2B)	Z2	572851 R	348,72
	V 12 S (PR-2B)	Z8	574748 R	124,51
	V 15 S (PR-2B)	Z8	574752 R	124,51
	V 18 S (PR-2B)	Z8	574756 R	124,51
	V 22 S (PR-2B)	Z8	574758 R	124,51
	V 28 S (PR-2B)	Z8	574760 R	124,51
V 35 S (PR-2B)	Z8	574762 R	136,96	

System	Pressing tongs / pressing rings	Driven by adapter tongs	Art.-No.	€	
EFFEBI	V 12		570107	154,61	
EFFEBI-PRESS	V 15		570115	154,61	
UNICO (GAS)	V 18		570125	154,61	
	V 22		570135	154,61	
	V 28		570145	154,61	
	V 35		570155	154,61	
	V 42		570165	360,13	
	V 42 (PR-2B)	Z2	572850 R	322,77	
	V 54		570175	370,51	
	V 54 (PR-2B)	Z2	572851 R	348,72	
	V 12 S (PR-2B)	Z8	574748 R	124,51	
	V 15 S (PR-2B)	Z8	574752 R	124,51	
	V 18 S (PR-2B)	Z8	574756 R	124,51	
	V 22 S (PR-2B)	Z8	574758 R	124,51	
	V 28 S (PR-2B)	Z8	574760 R	124,51	
V 35 S (PR-2B)	Z8	574762 R	136,96		
EFFEBI	M 15		570110	154,61	
PRESSTIGE	M 18		570120	154,61	
	M 22		570130	154,61	
	M 28		570140	154,61	
	M 35		570150	154,61	
	M 15 S (PR-2B)	Z8	574738 R	124,51	
	M 18 S (PR-2B)	Z8	574740 R	124,51	
	M 22 S (PR-2B)	Z8	574742 R	124,51	
	M 28 S (PR-2B)	Z8	574744 R	124,51	
	M 35 S (PR-2B)	Z8	574746 R	136,96	
	V 15		570115	154,61	
	V 18		570125	154,61	
	V 22		570135	154,61	
	V 28		570145	154,61	
V 35		570155	154,61		
V 42		570165	360,13		
V 42 (PR-2B)	Z2	572850 R	322,77		
V 54		570175	370,51		
V 54 (PR-2B)	Z2	572851 R	348,72		
V 15 S (PR-2B)	Z8	574752 R	124,51		
V 18 S (PR-2B)	Z8	574756 R	124,51		
V 22 S (PR-2B)	Z8	574758 R	124,51		
V 28 S (PR-2B)	Z8	574760 R	124,51		
V 35 S (PR-2B)	Z8	574762 R	136,96		
EFFEBI	M 15		570110	154,61	
PRESSTIGE 4E05	M 18		570120	154,61	
	M 22		570130	154,61	
	M 28		570140	154,61	
	M 35		570150	154,61	
	M 42 (PR-3S)	Z2	572706 R	672,57	
	M 54 (PR-3S)	Z2	572708 R	672,57	
	M 15 S (PR-2B)	Z8	574738 R	124,51	
	M 18 S (PR-2B)	Z8	574740 R	124,51	
	M 22 S (PR-2B)	Z8	574742 R	124,51	
	M 28 S (PR-2B)	Z8	574744 R	124,51	
	M 35 S (PR-2B)	Z8	574746 R	136,96	
	EFFEBI	M 15		570110	154,61
	PRESSTIGE-GAS	M 18		570120	154,61
M 22			570130	154,61	
M 28			570140	154,61	
M 35			570150	154,61	
M 42 (PR-3S)		Z2	572706 R	672,57	
M 54 (PR-3S)		Z2	572708 R	672,57	
M 15 S (PR-2B)		Z8	574738 R	124,51	
M 18 S (PR-2B)		Z8	574740 R	124,51	
M 22 S (PR-2B)		Z8	574742 R	124,51	
M 28 S (PR-2B)		Z8	574744 R	124,51	
M 35 S (PR-2B)		Z8	574746 R	136,96	
EFFEBI		M 15		570110	154,61
PRESSTIGE-GAS		M 18		570120	154,61
	M 22		570130	154,61	
	M 28		570140	154,61	
	M 35		570150	154,61	
	M 15 S (PR-2B)	Z8	574738 R	124,51	
	M 18 S (PR-2B)	Z8	574740 R	124,51	
	M 22 S (PR-2B)	Z8	574742 R	124,51	
	M 28 S (PR-2B)	Z8	574744 R	124,51	
	M 35 S (PR-2B)	Z8	574746 R	136,96	
	EFFEBI	TH 16*		570460	186,32
	TOF-GAS MULTIPINZA	TH 20*		570470	186,32
		TH 26*		570475	186,32
		TH 32		570480	186,32
TH 16 S (PR-2B)**		Z8	574782 R	124,51	
TH 20 S (PR-2B)**		Z8	574788 R	124,51	
TH 26 S (PR-2B)**		Z8	574794 R	124,51	
TH 32 S (PR-2B)		Z8	574798 R	136,96	
H 16*			570320	168,10	
H 20*			570350	168,10	
H 26*			570370	168,10	
H 32			570380	168,10	
H 40 (PZ-4G)			570390	565,67	
U 16*			570765	174,33	
U 20*		570775	174,33		
U 32		570785	204,43		



System	Pressing tongs/ pressing rings	Driven by adapter tongs	Art.-No.	€
EFFEBI TOF MULTIPINZA	TH 16*		570460	186,32
	TH 18*		570465	186,32
	TH 20*		570470	186,32
	TH 25*		570495	186,32
	TH 26*		570475	186,32
	TH 32		570480	186,32
	TH 40		570485	246,99
	TH 50 (PZ-S)		572400	645,58
	TH 63 (PZ-S)		572405	645,58
	TH 16 S (PR-2B)**	Z8	574782 R	124,51
	TH 18 S (PR-2B)**	Z8	574786 R	124,51
	TH 20 S (PR-2B)**	Z8	574788 R	124,51
	TH 25 S (PR-2B)**	Z8	574792 R	124,51
	TH 26 S (PR-2B)**	Z8	574794 R	124,51
	TH 26 S (PR-2B)**	Z8	574794 R	124,51
	TH 32 S (PR-2B)	Z8	574798 R	136,96
	F 16*		570717	177,45
	F 18*		570720	177,45
	F 20*		570727	177,45
	F 26*		570730	191,98
	F 32		570735	191,98
	Fz 40		570742	205,47
	Fz 50		570747	311,35
	F 63 (PZ-S)		572385	645,58
	F 16 S (PR-2B)**	Z8	574728 R	124,51
	F 20 S (PR-2B)**	Z8	574730 R	124,51
	F 24 S (PR-2B)**	Z8	574732 R	124,51
	F 32 S (PR-2B)	Z8	574734 R	136,96
	H 16*		570320	168,10
	H 18*		570340	168,10
	H 20*		570350	168,10
	H 25*		570360	168,10
	H 26*		570370	168,10
	H 32		570380	168,10
	H 40 (PZ-4G)		570390	565,67
	U 16*		570765	174,33
	U 18*		570770	174,33
U 20*		570775	174,33	
U 25*		570780	174,33	
U 26 <sup>12)</sup>		570750	204,43	
U 32		570785	204,43	
U 40		570790	249,07	
U 50		570795	298,89	
U 63 (PR-3B)	Z4	572837 R	733,81	
U 63 (PZ-S)		572365	645,58	
B 16*		570850	203,40	
B 18*		570855	203,40	
B 20*		570860	203,40	
B 26		570870	224,16	
B 32		570880	224,16	
EFIELD MULTILAYER PRESS DINGAS	U 16*		570765	174,33
	U 18*		570770	174,33
	U 20*		570775	174,33
	U 25*		570780	174,33
	U 32		570785	204,43
EFIELD MULTILAYER PRESS WATER	U 16*		570765	174,33
	U 18*		570770	174,33
	U 20*		570775	174,33
	U 25*		570780	174,33
	U 32		570785	204,43
Elkhart APOLLOXPRESS Fittings Copper and Low-Lead Brass	VUS ½" (OD 15,9 mm)		571770	186,79
	VUS ¾" (OD 22,2 mm)		571775	186,79
	VUS 1" (OD 28,6 mm)		571780	186,79
	VUS 1½" (OD 34,9 mm)		571785	186,79
	VUS 1½" (OD 41,3 mm)		571790	360,13
VUS 2" (OD 54,0 mm)		571795	370,51	
Elkhart APOLLOXPRESS LD-C Fittings Copper	VUSFz 2½" (PR-3B) (OD 66,7 mm)	Z5	572819 R	609,25
	VUSFz 3" (PR-3B) (OD 79,4 mm)	Z5	572820 R	609,25
	VUSFz 4" (PR-3B) (OD 104,8 mm)	Z5	572821 R	645,58

System	Pressing tongs/ pressing rings	Driven by adapter tongs	Art.-No.	€	
EMMETI GERPEX- FIVPRESS	B 16*		570850	203,40	
	B 20*		570860	203,40	
	B 26		570870	224,16	
	B 32		570880	224,16	
	H 16*		570320	168,10	
	H 20*		570350	168,10	
	TH 16*		570460	186,32	
	TH 20*		570470	186,32	
	TH 26*		570475	186,32	
	TH 32		570480	186,32	
	TH 40		570485	246,99	
	TH 50 (PZ-S)		572400	645,58	
	TH 63 (PZ-S)		572405	645,58	
	U 16*		570765	174,33	
	U 20*		570775	174,33	
	EMPUR	TH 14*		570455	186,32
		TH 15*		570457	186,32
		TH 16*		570460	186,32
		TH 17*		570462	186,32
		TH 20*		570470	186,32
		TH 25*		570495	186,32
		TH 14 S (PR-2B)**	Z8	574778 R	124,51
		TH 15 S (PR-2B)**	Z8	574780 R	124,51
		TH 16 S (PR-2B)**	Z8	574782 R	124,51
		TH 17 S (PR-2B)**	Z8	574784 R	124,51
		TH 20 S (PR-2B)**	Z8	574788 R	124,51
		TH 25 S (PR-2B)**	Z8	574792 R	124,51
	Esta Rohr simplesta SH M	M 15		570110	154,61
		M 18		570120	154,61
		M 22		570130	154,61
M 28			570140	154,61	
M 35			570150	154,61	
M 42 (PZ-4G)			570160	498,19	
M 54 (PZ-4G)			570170	498,19	
M 42 (PR-3S)		Z2	572706 R	672,57	
M 54 (PR-3S)		Z2	572708 R	672,57	
M 76,1 XL (PR-3S)		Z6 XL <sup>3)</sup> / Z7 XL 45 kN <sup>4)</sup>	579101 R	1.161,47	
M 88,9 G XL (PR-3S)		Z6 XL <sup>3)</sup> / Z7 XL 45 kN <sup>4)</sup>	579110 R	1.355,58	
M 108,0 G XL (PR-3S) <sup>8)</sup>		Z6 XL <sup>3)</sup> / Z7 XL 45 kN <sup>4)</sup>	579111 R	1.355,58	
M 15 S (PR-2B)		Z8	574738 R	124,51	
M 18 S (PR-2B)		Z8	574740 R	124,51	
M 22 S (PR-2B)		Z8	574742 R	124,51	
M 28 S (PR-2B)		Z8	574744 R	124,51	
M 35 S (PR-2B)		Z8	574746 R	136,96	
Esta Rohr simplesta ST M		M 15		570110	154,61
	M 18		570120	154,61	
	M 22		570130	154,61	
	M 28		570140	154,61	
	M 35		570150	154,61	
	M 42 (PZ-4G)		570160	498,19	
	M 54 (PZ-4G)		570170	498,19	
	M 42 (PR-3S)	Z2	572706 R	672,57	
	M 54 (PR-3S)	Z2	572708 R	672,57	
	M 76,1 XL (PR-3S)	Z6 XL <sup>3)</sup> / Z7 XL 45 kN <sup>4)</sup>	579101 R	1.161,47	
	M 88,9 G XL (PR-3S)	Z6 XL <sup>3)</sup> / Z7 XL 45 kN <sup>4)</sup>	579110 R	1.355,58	
	M 108,0 G XL (PR-3S) <sup>8)</sup>	Z6 XL <sup>3)</sup> / Z7 XL 45 kN <sup>4)</sup>	579111 R	1.355,58	
EUROTUBI EUROPA C-Steel Pressfitting System M-Profile <sup>1)</sup>	M 12		570100	154,61	
	M 15		570110	154,61	
	M 18		570120	154,61	
	M 22		570130	154,61	
	M 28		570140	154,61	
	M 35		570150	154,61	
	M 42 (PR-3S)	Z2	572706 R	672,57	
	M 54 (PR-3S)	Z2	572708 R	672,57	
	M 76,1 XL (PR-3S)	Z6 XL <sup>3)</sup> / Z7 XL 45 kN <sup>4)</sup>	579101 R	1.161,47	
	M 88,9 G XL (PR-3S)	Z6 XL <sup>3)</sup> / Z7 XL 45 kN <sup>4)</sup>	579110 R	1.355,58	
	M 108,0 G XL (PR-3S)	Z6 XL <sup>3)</sup> / Z7 XL 45 kN <sup>4)</sup>	579111 R	1.355,58	
	M 12 S (PR-2B)	Z8	574736 R	124,51	
M 15 S (PR-2B)	Z8	574738 R	124,51		
M 18 S (PR-2B)	Z8	574740 R	124,51		
M 22 S (PR-2B)	Z8	574742 R	124,51		
M 28 S (PR-2B)	Z8	574744 R	124,51		
M 35 S (PR-2B)	Z8	574746 R	136,96		

Pressfitting systems for gas installations must only be pressed with pressing tongs/pressing rings which are highlighted in yellow.

Observe the national regulations. Read and observe the instructions for use and the installation instructions of the system provider/manufacturer.

\* Can also be driven by the REMS Eco-Press manual radial press, see page 185. Observe the national regulations.

\*\* Can also be driven by the REMS Eco-Press manual radial press using the Z8 adapter tongs, see page 185. Observe the national regulations.

<sup>1)</sup> Only pressing tongs from designation "108" (1<sup>st</sup> quarter of 2008), "208" (2<sup>nd</sup> quarter of 2008) etc. can be used. The designation is stamped on every pressing jaw.

<sup>2)</sup> For this pressfitting system producing a pressing joint with manual radial presses is not permitted.

<sup>3)</sup> Driven by REMS Power-Press XL ACC, see page 188.

<sup>4)</sup> Driven by REMS Akku-Press XL 45 kN 22V ACC, see page 196.

<sup>5)</sup> For taking suitable pressing inserts.

<sup>6)</sup> Press fittings made of red bronze (Sanpress XL) must be pressed with pressing rings with press contour VR, copper fittings (Profipress XL, Profipress G XL), carbon steel (Prestabo XL) and stainless steel fittings (Sanpress Inox XL, Sanpress Inox G XL) with pressing rings with press contour VF.

<sup>7)</sup> Use pressing rings labelled "M 88.9 G" or "M 108 G" on the three pressing segments for gas installations.

<sup>8)</sup> For making press joints for operating pressure ≤ PN 10.

<sup>9)</sup> For pipes of the EN technical standard. Observe the instructions for use of the system provider/manufacturer.

<sup>10)</sup> For pipes of the ASTM technical standard. Observe the instructions for use of the system provider/manufacturer.

<sup>11)</sup> Only use pressing tongs identified by "VMP ½" G" on the pressing jaws for gas installations.

<sup>12)</sup> Previous designation: C 26 pressing tongs

The suitability of REMS pressing tools for pressfitting systems: Date 27.10.2023. For the updated situation regarding suitability status check our website: [www.rems.de](http://www.rems.de) > Downloads > Product catalogues, brochures > REMS Catalogue.

See page 238 for adapter tongs. Pressing tongs/pressing rings for additional pressfitting systems on request.

# REMS pressing tongs REMS pressing rings

Accessories for REMS radial presses (except for REMS Mini-Press)  
and suitable radial presses of other makes

System	Pressing tongs / pressing rings	Driven by adapter tongs	Art.-No.	€
EUROTUBI	M 15		570110	154,61
EUROPA	M 18		570120	154,61
Inox Pressfitting	M 22		570130	154,61
System M-Profile <sup>1)</sup>	M 28		570140	154,61
	M 35		570150	154,61
	M 42 (PR-3S)	Z2	572706 R	672,57
	M 54 (PR-3S)	Z2	572708 R	672,57
	M 76,1 XL (PR-3S)	Z6 XL <sup>3)</sup> / Z7 XL 45 kN <sup>4)</sup>	579101 R	1.161,47
	M 88,9 G XL (PR-3S)	Z6 XL <sup>3)</sup> / Z7 XL 45 kN <sup>4)</sup>	579110 R	1.355,58
	M 108,0 G XL (PR-3S)	Z6 XL <sup>3)</sup> / Z7 XL 45 kN <sup>4)</sup>	579111 R	1.355,58
	M 15 S (PR-2B)	Z8	574738 R	124,51
	M 18 S (PR-2B)	Z8	574740 R	124,51
	M 22 S (PR-2B)	Z8	574742 R	124,51
	M 28 S (PR-2B)	Z8	574744 R	124,51
	M 35 S (PR-2B)	Z8	574746 R	136,96
Evans	VAU 15 (½") (OD 12,7 mm)		572687	159,80
Components	VAU 20 (¾") (OD 19,1 mm)		572689	159,80
Presslok	VAU 25 (1") (OD 25,4 mm)		572691	159,80
	ECI 1½"		571932	200,28
	ECI 2" (PZ-4G)		571934	498,19
	ECI 2½" XL (PR-3S)	Z6 XL <sup>3)</sup> / Z7 XL 45 kN <sup>4)</sup>	579104 R	1.056,63
	ECI 3" XL (PR-3S)	Z6 XL <sup>3)</sup> / Z7 XL 45 kN <sup>4)</sup>	579105 R	1.161,47
	ECI 4" XL (PR-3S)	Z6 XL <sup>3)</sup> / Z7 XL 45 kN <sup>4)</sup>	579106 R	1.355,58
<b>F</b>				
FAR Rubinetterie	TH 14*		570455	186,32
PRESSFAR	TH 16*		570460	186,32
	TH 17*		570462	186,32
	TH 18*		570465	186,32
	TH 20*		570470	186,32
	TH 25*		570495	186,32
	TH 26*		570475	186,32
	TH 32		570480	186,32
	TH 40		570485	246,99
	TH 50 (PZ-S)		572400	645,58
	TH 63 (PZ-S)		572405	645,58
	TH 14 S (PR-2B)**	Z8	574778 R	124,51
	TH 16 S (PR-2B)**	Z8	574782 R	124,51
	TH 17 S (PR-2B)**	Z8	574784 R	124,51
	TH 18 S (PR-2B)**	Z8	574786 R	124,51
	TH 20 S (PR-2B)**	Z8	574788 R	124,51
	TH 25 S (PR-2B)**	Z8	574792 R	124,51
	TH 26 S (PR-2B)**	Z8	574794 R	124,51
	TH 32 S (PR-2B)	Z8	574798 R	136,96
	H 14*		570310	168,10
	H 16*		570320	168,10
	H 18*		570340	168,10
	H 20*		570350	168,10
	H 26*		570370	168,10
	H 32		570380	168,10
	H 40 (PZ-4G)		570390	565,67
	U 14*		570760	174,33
	U 16*		570765	174,33
	U 18*		570770	174,33
	U 20*		570775	174,33
	U 25*		570780	174,33
	U 32		570785	204,43
	U 40		570790	249,07
	U 50		570795	298,89
	U 63 (PR-3B)	Z4	572837 R	733,81
	U 63 (PZ-S)		572365	645,58
F.B.Q. BARONIO	V 12		570107	154,61
BQ PRESS SOLAR	V 14		570112	154,61
	V 15		570115	154,61
	V 16		570117	154,61
	V 18		570125	154,61
	V 22		570135	154,61
	V 28		570145	154,61
	V 35		570155	154,61
	V 42		570165	360,13
	V 42 (PR-2B)	Z2	572850 R	322,77
	V 54		570175	370,51
	V 54 (PR-2B)	Z2	572851 R	348,72
	V 12 S (PR-2B)	Z8	574748 R	124,51
	V 14 S (PR-2B)	Z8	574800 R	124,51
	V 15 S (PR-2B)	Z8	574752 R	124,51
	VG 16 S (PR-2B)	Z8	574754 R	124,51
	V 18 S (PR-2B)	Z8	574756 R	124,51
	V 22 S (PR-2B)	Z8	574758 R	124,51
	V 28 S (PR-2B)	Z8	574760 R	124,51
	V 35 S (PR-2B)	Z8	574762 R	136,96
F.B.Q. BARONIO	V 12		570107	154,61
BQ PRESS WATER	V 14		570112	154,61
	V 15		570115	154,61
	V 16		570117	154,61
	V 18		570125	154,61
	V 22		570135	154,61
	V 28		570145	154,61
	V 35		570155	154,61
	V 42		570165	360,13
	V 42 (PR-2B)	Z2	572850 R	322,77
	V 54		570175	370,51
	V 54 (PR-2B)	Z2	572851 R	348,72
	V 12 S (PR-2B)	Z8	574748 R	124,51
	V 14 S (PR-2B)	Z8	574800 R	124,51
	V 15 S (PR-2B)	Z8	574752 R	124,51
	VG 16 S (PR-2B)	Z8	574754 R	124,51
	V 18 S (PR-2B)	Z8	574756 R	124,51
	V 22 S (PR-2B)	Z8	574758 R	124,51
	V 28 S (PR-2B)	Z8	574760 R	124,51
	V 35 S (PR-2B)	Z8	574762 R	136,96

System	Pressing tongs / pressing rings	Driven by adapter tongs	Art.-No.	€
F.B.Q. BARONIO	V 12		570107	154,61
BQ PRESS GAS	V 14		570112	154,61
	V 15		570115	154,61
	V 16		570117	154,61
	V 18		570125	154,61
	V 22		570135	154,61
	V 28		570145	154,61
	V 35		570155	154,61
	V 42		570165	360,13
	V 42 (PR-2B)	Z2	572850 R	322,77
	V 54		570175	370,51
	V 54 (PR-2B)	Z2	572851 R	348,72
	V 12 S (PR-2B)	Z8	574748 R	124,51
	V 14 S (PR-2B)	Z8	574800 R	124,51
	V 15 S (PR-2B)	Z8	574752 R	124,51
	VG 16 S (PR-2B)	Z8	574754 R	124,51
	V 18 S (PR-2B)	Z8	574756 R	124,51
	V 22 S (PR-2B)	Z8	574758 R	124,51
	V 28 S (PR-2B)	Z8	574760 R	124,51
	V 35 S (PR-2B)	Z8	574762 R	136,96
FERCOFLOOR	RfZ 16*		571325	194,05
DUO Press	RfZ 20*		571330	194,05
FERCO PEX	RfZ 25		571335	194,05
	RfZ 32		571340	194,05
	TH 16*		570460	186,32
	TH 20*		570470	186,32
	TH 25*		570495	186,32
	TH 32		570480	186,32
	TH 40		570485	246,99
	TH 50 (PZ-S)		572400	645,58
	TH 63 (PZ-S)		572405	645,58
	TH 16 S (PR-2B)**	Z8	574782 R	124,51
	TH 20 S (PR-2B)**	Z8	574788 R	124,51
	TH 25 S (PR-2B)**	Z8	574792 R	124,51
	TH 32 S (PR-2B)	Z8	574798 R	136,96
FERCOFLOOR	RfZ 16*		571325	194,05
DUO Press	RfZ 20*		571330	194,05
MULTIFER	RfZ 25		571335	194,05
	RfZ 32		571340	194,05
	TH 16*		570460	186,32
	TH 20*		570470	186,32
	TH 25*		570495	186,32
	TH 32		570480	186,32
	TH 40		570485	246,99
	TH 50 (PZ-S)		572400	645,58
	TH 63 (PZ-S)		572405	645,58
	TH 16 S (PR-2B)**	Z8	574782 R	124,51
	TH 20 S (PR-2B)**	Z8	574788 R	124,51
	TH 25 S (PR-2B)**	Z8	574792 R	124,51
	TH 32 S (PR-2B)	Z8	574798 R	136,96
	U 16*		570765	174,33
	U 18*		570770	174,33
	U 20*		570775	174,33
	U 25*		570780	174,33
	U 32		570785	204,43
	U 40		570790	249,07
	U 50		570795	298,89
	U 63 (PZ-S)		572365	645,58
FERRO systems	TH 16*		570460	186,32
BRASELI	TH 20*		570470	186,32
GPF GAS	TH 25*		570495	186,32
	TH 32		570480	186,32
	TH 16 S (PR-2B)**	Z8	574782 R	124,51
	TH 20 S (PR-2B)**	Z8	574788 R	124,51
	TH 25 S (PR-2B)**	Z8	574792 R	124,51
	TH 32 S (PR-2B)	Z8	574798 R	136,96
FERRO systems	U 16*		570765	174,33
BRASELI	U 18*		570770	174,33
GPF MULT	U 20*		570775	174,33
Pressfitting	U 25*		570780	174,33
MULTICAPA	U 32		570785	204,43
	U 40		570790	249,07
	U 50		570795	298,89
FERRO systems	U 16*		570765	174,33
BRASELI	U 18*		570770	174,33
GPF PPSU	U 20*		570775	174,33
Pressfitting	U 25*		570780	174,33
PEX y MULTICAPA	U 32		570785	204,43
	U 40		570790	249,07
	U 50		570795	298,89
FERRO systems	RfZ 16*		571325	194,05
BRASELI	RfZ 20*		571330	194,05
GPF PRESS	RfZ 25		571335	194,05
Pressfitting PEX	RfZ 32		571340	194,05
FILINOX	FTB 15		571432	224,16
Filpress	FTB 18		571434	224,16
	FTB 22		571436	224,16
	FTB 28		571438	224,16
	M 42 (PR-3S)	Z2	572706 R	672,57
	M 54 (PR-3S)	Z2	572708 R	672,57
	M 76,1 XL (PR-3S)	Z7 XL 45 kN <sup>4)</sup>	579101 R	1.161,47
	M 88,9 G XL (PR-3S)	Z7 XL 45 kN <sup>4)</sup>	579110 R	1.355,58
	M 108,0 G XL (PR-3S)	Z7 XL 45 kN <sup>4)</sup>	579111 R	1.355,58

**REMS pressing tongs**  
**REMS pressing rings**

Accessories for REMS radial presses (except for REMS Mini-Press)  
and suitable radial presses of other makes

System	Pressing tongs/ pressing rings	Driven by adapter tongs	Art.-No.	€	
FILINOX Instalpress Steel	M 15		570110	154,61	
	M 18		570120	154,61	
	M 22		570130	154,61	
	M 28		570140	154,61	
	M 35		570150	154,61	
	M 42 (PR-3S)	Z2	572706 R	672,57	
	M 54 (PR-3S)	Z2	572708 R	672,57	
	M 76,1 XL (PR-3S)	Z7 XL 45 kN <sup>(4)</sup>	579101 R	1.161,47	
	M 88,9 G XL (PR-3S)	Z7 XL 45 kN <sup>(4)</sup>	579110 R	1.355,58	
	M 108,0 G XL (PR-3S)	Z7 XL 45 kN <sup>(4)</sup>	579111 R	1.355,58	
	M 15 S (PR-2B)	Z8	574738 R	124,51	
	M 18 S (PR-2B)	Z8	574740 R	124,51	
	M 22 S (PR-2B)	Z8	574742 R	124,51	
	M 28 S (PR-2B)	Z8	574744 R	124,51	
	M 35 S (PR-2B)	Z8	574746 R	136,96	
	FILINOX Instalpress Inox	M 15		570110	154,61
		M 18		570120	154,61
		M 22		570130	154,61
M 28			570140	154,61	
M 35			570150	154,61	
M 42 (PR-3S)		Z2	572706 R	672,57	
M 54 (PR-3S)		Z2	572708 R	672,57	
M 76,1 XL (PR-3S)		Z7 XL 45 kN <sup>(4)</sup>	579101 R	1.161,47	
M 88,9 G XL (PR-3S)		Z7 XL 45 kN <sup>(4)</sup>	579110 R	1.355,58	
M 108,0 G XL (PR-3S)		Z7 XL 45 kN <sup>(4)</sup>	579111 R	1.355,58	
M 15 S (PR-2B)		Z8	574738 R	124,51	
M 18 S (PR-2B)		Z8	574740 R	124,51	
M 22 S (PR-2B)		Z8	574742 R	124,51	
M 28 S (PR-2B)		Z8	574744 R	124,51	
M 35 S (PR-2B)		Z8	574746 R	136,96	
FITTINGS ESTÁNDAR ECO-PRESS		RFz 16*		571325	194,05
		RFz 20*		571330	194,05
		RFz 25		571335	194,05
	RFz 32		571340	194,05	
FITTINGS ESTÁNDAR MULTICAPA	RFz 16*		571325	194,05	
	RFz 18*		571327	194,05	
	RFz 20*		571330	194,05	
	RFz 25		571335	194,05	
	RFz 32		571340	194,05	
FITTINGS ESTÁNDAR PE-X	RFz 16*		571325	194,05	
	RFz 20*		571330	194,05	
	RFz 25		571335	194,05	
	RFz 32		571340	194,05	
	FORNARA ForPress	B 16*		570850	203,40
B 20*			570860	203,40	
B 26			570870	224,16	
B 32			570880	224,16	
F 16*			570717	177,45	
F 20*			570727	177,45	
F 26*			570730	191,98	
F 32			570735	191,98	
F 16 S (PR-2B)**		Z8	574728 R	124,51	
F 20 S (PR-2B)**		Z8	574730 R	124,51	
F 26 S (PR-2B)**		Z8	574732 R	124,51	
F 32 S (PR-2B)		Z8	574734 R	136,96	
H 16*			570320	168,10	
H 20*			570350	168,10	
H 26*			570370	168,10	
H 32			570380	168,10	
TH 16*			570460	186,32	
TH 20*			570470	186,32	
TH 26*			570475	186,32	
TH 32			570480	186,32	
TH 16 S (PR-2B)**		Z8	574782 R	124,51	
TH 20 S (PR-2B)**		Z8	574788 R	124,51	
TH 26 S (PR-2B)**		Z8	574794 R	124,51	
TH 32 S (PR-2B)		Z8	574798 R	136,96	
U 16*			570765	174,33	
U 20*			570775	174,33	
U 26* <sup>(12)</sup>			570750	204,43	
U 32			570785	204,43	

System	Pressing tongs/ pressing rings	Driven by adapter tongs	Art.-No.	€	
FORZA WATER CRIMP (AUS)	K16/P18*		572600	194,05	
	K/20*		572605	194,05	
	K/25*		572610	194,05	
	K32		572615	194,05	
	K1/40		572620	194,05	
	K1/50		572625	318,61	
FORZA STAINLESS WATER CRIMP	K16/P18*		572600	194,05	
	K/20*		572605	194,05	
FORZA STESSO PEX WATER AND GAS CRIMP (AUS)	U 16*		570765	174,33	
	U 20*		570775	174,33	
	U 25*		570780	174,33	
	U 32		570785	204,43	
	U 40		570790	249,07	
	U 50 U 63 (PZ-S)		570795 572365	298,89 645,58	
FORZA GAS CRIMP (AUS)	K16/P18*		572600	194,05	
	K/20*		572605	194,05	
	K/25*		572610	194,05	
	K32		572615	194,05	
	K1/40		572620	194,05	
	K1/50		572625	318,61	
FORZA COPPER V PRESS (AUS)	VAU 15 (OD 12,7 mm)		572687	159,80	
	VAU 20 (OD 19,1 mm)		572689	159,80	
	VAU 25 (OD 25,4 mm)		572691	159,80	
	VAU 32 (OD 31,8 mm)		572693	168,10	
	VAU 40 (OD 38,1 mm)		572695	249,07	
	VAU 50 (OD 50,8 mm)		572697	441,10	
	VAUFz 65 (PR-3B) (OD 63,5 mm)	Z5	572839 R	609,25	
	VAUFz 80 (PR-3B) (OD 76,2 mm)	Z5	572840 R	609,25	
	VAUFz 100 (PR-3B) (OD 101,6 mm)	Z5	572841 R	645,58	
	VAU 15 S (PR-2B) (OD 12,7 mm)	Z8	574804 R	124,51	
	VAU 20 S (PR-2B)** (OD 19,1 mm)	Z8	574806 R	124,51	
	VAU 25 S (PR-2B)** (OD 25,4 mm)	Z8	574808 R	136,96	
	FORZA STAINLESS V PRESS (AUS)	V 15		570115	154,61
V 22			570135	154,61	
V 28			570145	154,61	
V 35			570155	154,61	
V 42			570165	360,13	
V 54			570175	370,51	
M 76,1 XL (PR-3S)		Z6 XL <sup>(3)</sup> / Z7 XL 45 kN <sup>(4)</sup>	579101 R	1.161,47	
M 88,9 G XL (PR-3S)		Z6 XL <sup>(3)</sup> / Z7 XL 45 kN <sup>(4)</sup>	579110 R	1.355,58	
M 108,0 G XL (PR-3S)		Z6 XL <sup>(3)</sup> / Z7 XL 45 kN <sup>(4)</sup>	579111 R	1.355,58	
V 15 S (PR-2B)		Z8	574752 R	124,51	
V 22 S (PR-2B)		Z8	574758 R	124,51	
V 28 S (PR-2B)		Z8	574760 R	124,51	
V 35 S (PR-2B)		Z8	574762 R	136,96	
FRABO FRABOPRESS 316 GAS M		M 15		570110	154,61
		M 18		570120	154,61
		M 22		570130	154,61
	M 28		570140	154,61	
	M 35		570150	154,61	
	M 42 (PR-3S)	Z2	572706 R	672,57	
	M 54 (PR-3S)	Z2	572708 R	672,57	
	M 15 S (PR-2B)	Z8	574738 R	124,51	
	M 18 S (PR-2B)	Z1	574740 R	124,51	
	M 22 S (PR-2B)	Z8	574742 R	124,51	
	M 28 S (PR-2B)	Z8	574744 R	124,51	
	M 35 S (PR-2B)	Z8	574746 R	136,96	
	FRABO FRABOPRESS 316 GAS V	V 15		570115	154,61
		V 18		570125	154,61
		V 22		570135	154,61
		V 28		570145	154,61
V 35			570155	154,61	
V 42			570165	360,13	
V 42 (PR-2B)		Z2	572850 R	322,77	
V 54			570175	370,51	
V 54 (PR-2B)		Z2	572851 R	348,72	
V 15 S (PR-2B)		Z8	574752 R	124,51	
V 18 S (PR-2B)		Z8	574756 R	124,51	
V 22 S (PR-2B)		Z8	574758 R	124,51	
V 28 S (PR-2B)		Z8	574760 R	124,51	
V 35 S (PR-2B)		Z8	574762 R	136,96	

Pressfitting systems for gas installations must only be pressed with pressing tongs/pressing rings which are highlighted in yellow.

Observe the national regulations. Read and observe the instructions for use and the installation instructions of the system provider/manufacturer.

\* Can also be driven by the REMS Eco-Press manual radial press, see page 185. Observe the national regulations.

\*\* Can also be driven by the REMS Eco-Press manual radial press using the Z8 adapter tongs, see page 185. Observe the national regulations.

<sup>1)</sup> Only pressing tongs from designation "108" (1<sup>st</sup> quarter of 2008), "208" (2<sup>nd</sup> quarter of 2008) etc. can be used. The designation is stamped on every pressing jaw.

<sup>2)</sup> For this pressfitting system producing a pressing joint with manual radial presses is not permitted.

<sup>3)</sup> Driven by REMS Power-Press XL ACC, see page 188.

<sup>4)</sup> Driven by REMS Akku-Press XL 45 kN 22V ACC, see page 196.

<sup>5)</sup> For taking suitable pressing inserts.

<sup>6)</sup> Press fittings made of red bronze (Sanpress XL) must be pressed with pressing rings with press contour VR, copper fittings (Profipress XL, Profipress G XL), carbon steel (Prestabo XL) and stainless steel fittings (Sanpress Inox XL, Sanpress Inox G XL) with pressing rings with press contour VF.

<sup>7)</sup> Use pressing rings labelled "M 88.9 G" or "M 108 G" on the three pressing segments for gas installations.

<sup>8)</sup> For making press joints for operating pressure ≤ PN 10.

<sup>9)</sup> For pipes of the EN technical standard. Observe the instructions for use of the system provider/manufacturer.

<sup>10)</sup> For pipes of the ASTM technical standard. Observe the instructions for use of the system provider/manufacturer.

<sup>11)</sup> Only use pressing tongs identified by "VMP 1/2" G" on the pressing jaws for gas installations.

<sup>12)</sup> Previous designation: C 26 pressing tongs

The suitability of REMS pressing tools for pressfitting systems: Date 27.10.2023. For the updated situation regarding suitability status check our website:

www.rems.de > Downloads > Product catalogues, brochures > REMS Catalogue.

See page 238 for adapter tongs. Pressing tongs/pressing rings for additional pressfitting systems on request.



# REMS pressing tongs REMS pressing rings

Accessories for REMS radial presses (except for REMS Mini-Press) and suitable radial presses of other makes

System	Pressing tongs/ pressing rings	Driven by adapter tongs	Art.-No.	€	
Fränkische alpeX L	Fz 40		570742	205,47	
	Fz 50		570747	311,35	
	F 63 (PZ-S)		572385	645,58	
	Fz 75 (PR-3B)	24	572830 R	609,25	
<b>G</b>					
gaboTherm H+S	TH 10*		570467	186,32	
	TH 12*		570452	186,32	
	TH 14*		570455	186,32	
	TH 15*		570457	186,32	
	TH 16*		570460	186,32	
	TH 17*		570462	186,32	
	TH 18*		570465	186,32	
	TH 20*		570470	186,32	
	TH 25*		570495	186,32	
	TH 26*		570475	186,32	
	TH 32		570480	186,32	
	TH 40		570485	246,99	
	TH 50 (PZ-S)		572400	645,58	
	TH 63 (PZ-S)		572405	645,58	
	TH 10 S (PR-2B)**	Z8	574772 R	124,51	
	TH 12 S (PR-2B)**	Z8	574776 R	124,51	
	TH 14 S (PR-2B)**	Z8	574778 R	124,51	
	TH 15 S (PR-2B)**	Z8	574780 R	124,51	
	TH 16 S (PR-2B)**	Z8	574782 R	124,51	
	TH 17 S (PR-2B)**	Z8	574784 R	124,51	
	TH 18 S (PR-2B)**	Z8	574786 R	124,51	
	TH 20 S (PR-2B)**	Z8	574788 R	124,51	
	TH 25 S (PR-2B)**	Z8	574792 R	124,51	
	TH 26 S (PR-2B)**	Z8	574794 R	124,51	
	TH 32 S (PR-2B)**	Z8	574798 R	136,96	
	Gallagher USA YogaPipe ACR	H 12* (¼")		570300	168,10
		U 14* (⅜")		570760	174,33
U 16* (½")			570765	174,33	
U 18* (⅝")			570770	174,33	
U 20* (¾")			570775	174,33	
U 25* (7/8")			570780	174,33	
U 32 (1")			570785	204,43	
Geberit Mapress C-STAHl	M 12		570100	154,61	
	M 15		570110	154,61	
	M 18		570120	154,61	
	M 22		570130	154,61	
	M 28		570140	154,61	
	M 35		570150	154,61	
	M 35 (PR-3S)	Z2	572727 R	672,57	
	M 42 (PZ-4G)		570160	498,19	
	M 54 (PZ-4G)		570170	498,19	
	M 42 (PR-3S)	Z2	572706 R	672,57	
	M 54 (PR-3S)	Z2	572708 R	672,57	
	M 66,7 XL (PR-3S)	Z6 XL <sup>3)</sup> / Z7 XL 45 kN <sup>4)</sup>	579107 R	1.161,47	
	M 76,1 XL (PR-3S)	Z6 XL <sup>3)</sup> / Z7 XL 45 kN <sup>4)</sup>	579101 R	1.161,47	
	M 88,9 G XL (PR-3S)	Z6 XL <sup>3)</sup> / Z7 XL 45 kN <sup>4)</sup>	579110 R	1.355,58	
	M 108,0 G XL (PR-3S)	Z6 XL <sup>3)</sup> / Z7 XL 45 kN <sup>4)</sup>	579111 R	1.355,58	
	M 12 S (PR-2B)	Z8	574736 R	124,51	
	M 15 S (PR-2B)	Z8	574738 R	124,51	
	M 18 S (PR-2B)	Z8	574740 R	124,51	
	M 22 S (PR-2B)	Z8	574742 R	124,51	
	M 28 S (PR-2B)	Z8	574744 R	124,51	
	M 35 S (PR-2B)	Z8	574746 R	136,96	
Geberit Mapress C-STAHl Sprinkler nass	M 22		570130	154,61	
	M 28		570140	154,61	
	M 35 (PR-3S)	Z2	572727 R	672,57	
	M 42 (PR-3S)	Z2	572706 R	672,57	
	M 54 (PR-3S)	Z2	572708 R	672,57	
	M 66,7 XL (PR-3S)	Z6 XL <sup>3)</sup> / Z7 XL 45 kN <sup>4)</sup>	579107 R	1.161,47	
	M 76,1 XL (PR-3S)	Z6 XL <sup>3)</sup> / Z7 XL 45 kN <sup>4)</sup>	579101 R	1.161,47	
	M 88,9 G XL (PR-3S)	Z6 XL <sup>3)</sup> / Z7 XL 45 kN <sup>4)</sup>	579110 R	1.355,58	
	M 108,0 G XL (PR-3S)	Z6 XL <sup>3)</sup> / Z7 XL 45 kN <sup>4)</sup>	579111 R	1.355,58	

System	Pressing tongs/ pressing rings	Driven by adapter tongs	Art.-No.	€
Geberit Mapress Edelstahl	M 12		570100	154,61
	M 15		570110	154,61
	M 18		570120	154,61
	M 22		570130	154,61
	M 28		570140	154,61
	M 35		570150	154,61
	M 35 (PR-3S)	Z2	572727 R	672,57
	M 42 (PZ-4G)		570160	498,19
	M 54 (PZ-4G)		570170	498,19
	M 42 (PR-3S)	Z2	572706 R	672,57
	M 54 (PR-3S)	Z2	572708 R	672,57
	M 76,1 XL (PR-3S)	Z6 XL <sup>3)</sup> / Z7 XL 45 kN <sup>4)</sup>	579107 R	1.161,47
	M 88,9 G XL (PR-3S)	Z6 XL <sup>3)</sup> / Z7 XL 45 kN <sup>4)</sup>	579110 R	1.355,58
	M 108,0 G XL (PR-3S)	Z6 XL <sup>3)</sup> / Z7 XL 45 kN <sup>4)</sup>	579111 R	1.355,58
	M 12 S (PR-2B)	Z8	574736 R	124,51
	M 15 S (PR-2B)	Z8	574738 R	124,51
	M 18 S (PR-2B)	Z8	574740 R	124,51
	M 22 S (PR-2B)	Z8	574742 R	124,51
	M 28 S (PR-2B)	Z8	574744 R	124,51
	M 35 S (PR-2B)	Z8	574746 R	136,96
Geberit Mapress Edelstahl Gas	M 15		570110	154,61
	M 18		570120	154,61
	M 22		570130	154,61
	M 28		570140	154,61
	M 35		570150	154,61
	M 35 (PR-3S)	Z2	572727 R	672,57
	M 42 (PR-3S)	Z2	572706 R	672,57
	M 54 (PR-3S)	Z2	572708 R	672,57
	M 76,1 XL (PR-3S)	Z6 XL <sup>3)</sup> / Z7 XL 45 kN <sup>4)</sup>	579107 R	1.161,47
	M 88,9 G XL (PR-3S) <sup>7)</sup>	Z6 XL <sup>3)</sup> / Z7 XL 45 kN <sup>4)</sup>	579110 R	1.355,58
	M 108,0 G XL (PR-3S) <sup>7)</sup>	Z6 XL <sup>3)</sup> / Z7 XL 45 kN <sup>4)</sup>	579111 R	1.355,58
Geberit Mapress Edelstahl Sprinkler	M 22		570130	154,61
	M 28		570140	154,61
	M 35 (PR-3S)	Z2	572727 R	672,57
	M 42 (PR-3S)	Z2	572706 R	672,57
	M 54 (PR-3S)	Z2	572708 R	672,57
	M 66,7 XL (PR-3S)	Z6 XL <sup>3)</sup> / Z7 XL 45 kN <sup>4)</sup>	579107 R	1.161,47
	M 76,1 XL (PR-3S)	Z6 XL <sup>3)</sup> / Z7 XL 45 kN <sup>4)</sup>	579101 R	1.161,47
	M 88,9 G XL (PR-3S)	Z6 XL <sup>3)</sup> / Z7 XL 45 kN <sup>4)</sup>	579110 R	1.355,58
	M 108,0 G XL (PR-3S)	Z6 XL <sup>3)</sup> / Z7 XL 45 kN <sup>4)</sup>	579111 R	1.355,58
	M 12 S (PR-2B)	Z8	574736 R	124,51
	M 15 S (PR-2B)	Z8	574738 R	124,51
Geberit Mapress Kupfer	M 12		570100	154,61
	M 15		570110	154,61
	M 18		570120	154,61
	M 22		570130	154,61
	M 28		570140	154,61
	M 35		570150	154,61
	M 35 (PR-3S)	Z2	572727 R	672,57
	M 42 (PZ-4G)		570160	498,19
	M 54 (PZ-4G)		570170	498,19
	M 42 (PR-3S)	Z2	572706 R	672,57
Geberit Mapress Kupfer Gas	M 15		570110	154,61
	M 18		570120	154,61
	M 22		570130	154,61
	M 28		570140	154,61
	M 35		570150	154,61
	M 35 (PR-3S)	Z2	572727 R	672,57
	M 42 (PR-3S)	Z2	572706 R	672,57
	M 54 (PR-3S)	Z2	572708 R	672,57
	M 15 S (PR-2B)	Z8	574738 R	124,51
	M 18 S (PR-2B)	Z8	574740 R	124,51

Pressfitting systems for gas installations must only be pressed with pressing tongs/pressing rings which are highlighted in yellow.

Observe the national regulations. Read and observe the instructions for use and the installation instructions of the system provider/manufacturer.

\* Can also be driven by the REMS Eco-Press manual radial press, see page 185. Observe the national regulations.

\*\* Can also be driven by the REMS Eco-Press manual radial press using the Z8 adapter tongs, see page 185. Observe the national regulations.

<sup>1)</sup> Only pressing tongs from designation "108" (1<sup>st</sup> quarter of 2008), "208" (2<sup>nd</sup> quarter of 2008) etc. can be used. The designation is stamped on every pressing jaw.

<sup>2)</sup> For this pressfitting system producing a pressing joint with manual radial presses is not permitted.

<sup>3)</sup> Driven by REMS Power-Press XL ACC, see page 188.

<sup>4)</sup> Driven by REMS Akku-Press XL 45 kN 22V ACC, see page 196.

<sup>5)</sup> For taking suitable pressing inserts.

<sup>6)</sup> Press fittings made of red bronze (Sanpress XL) must be pressed with pressing rings with press contour VR, copper fittings (Profipress XL, Profipress G XL), carbon steel (Prestabo XL) and stainless steel fittings (Sanpress Inox XL, Sanpress Inox G XL) with pressing rings with press contour VF.

<sup>7)</sup> Use pressing rings labelled "M 88,9 G" or "M 108 G" on the three pressing segments for gas installations.

<sup>8)</sup> For making press joints for operating pressure ≤ PN 10.

<sup>9)</sup> For pipes of the EN technical standard. Observe the instructions for use of the system provider/manufacturer.

<sup>10)</sup> For pipes of the ASTM technical standard. Observe the instructions for use of the system provider/manufacturer.

<sup>11)</sup> Only use pressing tongs identified by "VMP ½" G" on the pressing jaws for gas installations.

<sup>12)</sup> Previous designation: C 26 pressing tongs

The suitability of REMS pressing tools for pressfitting systems: Date 27.10.2023. For the updated situation regarding suitability status check our website: [www.rems.de](http://www.rems.de) > Downloads > Product catalogues, brochures > REMS Catalogue.

See page 238 for adapter tongs. Pressing tongs/pressing rings for additional pressfitting systems on request.

# REMS pressing tongs REMS pressing rings

## Accessories for REMS radial presses (except for REMS Mini-Press) and suitable radial presses of other makes

System	Pressing tongs / pressing rings	Driven by adapter tongs	Art.-No.	€
Geberit Mepla	G 16*		570400	186,79
	G 20*		570410	186,79
	G 26*		570420	198,21
	G 32		570430	211,70
	G 40		570440	273,98
	G 50		570450	286,44
G 63 (PZ-S)		572470	809,59	
Geberit Mepla Therm	G 16*		570400	186,79
	G 20*		570410	186,79
	G 26*		570420	198,21
Geberit Volex	TH 16*		570460	186,32
	TH 20*		570470	186,32
	TH 26*		570475	186,32
General Fittings 5T00	H 16*		570320	168,10
	H 20*		570350	168,10
	H 26*		570370	168,10
	H 32		570380	168,10
	TH 16*		570460	186,32
	TH 20*		570470	186,32
	TH 26*		570475	186,32
	TH 32		570480	186,32
	TH 40		570485	246,99
	TH 50 (PZ-S)		572400	645,58
	TH 63 (PZ-S)		572405	645,58
	TH 16 S (PR-2B)**	Z8	574782 R	124,51
	TH 20 S (PR-2B)**	Z8	574788 R	124,51
	TH 26 S (PR-2B)**	Z8	574794 R	124,51
	TH 32 S (PR-2B)	Z8	574798 R	136,96
	U 16*		570765	174,33
	U 20*		570775	174,33
	U 32		570785	204,43
	U 40		570790	249,07
	U 63 (PZ-S)		572365	645,58
U 63 (PR-3B)	Z4	572837 R	733,81	
General Fittings Ewoprex	H 16*		570320	168,10
	H 20*		570350	168,10
	H 26*		570370	168,10
	H 32		570380	168,10
	TH 16*		570460	186,32
	TH 20*		570470	186,32
	TH 26*		570475	186,32
	TH 32		570480	186,32
	TH 40		570485	246,99
	TH 50 (PZ-S)		572400	645,58
	TH 63 (PZ-S)		572405	645,58
	TH 16 S (PR-2B)**	Z8	574782 R	124,51
	TH 20 S (PR-2B)**	Z8	574788 R	124,51
	TH 26 S (PR-2B)**	Z8	574794 R	124,51
	TH 32 S (PR-2B)	Z8	574798 R	136,96
	U 16*		570765	174,33
	U 20*		570775	174,33
	U 32		570785	204,43
	U 40		570790	249,07
	U 63 (PZ-S)		572365	645,58
U 63 (PR-3B)	Z4	572837 R	733,81	
General Fittings Serie 5S00	B 16*		570850	203,40
	B 18*		570855	203,40
	B 20*		570860	203,40
	B 26		570870	224,16
	B 32		570880	224,16
	F 16*		570717	177,45
	F 20*		570727	177,45
	F 26*		570730	191,98
	F 32		570735	191,98
	F 16 S (PR-2B)**	Z8	574728 R	124,51
	F 20 S (PR-2B)**	Z8	574730 R	124,51
	F 26 S (PR-2B)**	Z8	574732 R	124,51
	F 32 S (PR-2B)	Z8	574734 R	136,96
	H 16*		570320	168,10
	H 18*		570340	168,10
	H 20*		570350	168,10
	H 25*		570360	168,10
	H 26*		570370	168,10
	H 32		570380	168,10
	H 40 (PZ-4G)		570390	565,67
	TH 16*		570460	186,32
	TH 18*		570465	186,32
	TH 20*		570470	186,32
	TH 25*		570495	186,32
	TH 26*		570475	186,32
	TH 32		570480	186,32
	TH 40		570485	246,99
	TH 50 (PZ-S)		572400	645,58
	TH 63 (PZ-S)		572405	645,58
	TH 16 S (PR-2B)**	Z8	574782 R	124,51
	TH 18 S (PR-2B)**	Z8	574786 R	124,51
	TH 20 S (PR-2B)**	Z8	574788 R	124,51
	TH 25 S (PR-2B)**	Z8	574792 R	124,51
	TH 26 S (PR-2B)**	Z8	574794 R	124,51
	TH 32 S (PR-2B)	Z8	574798 R	136,96
	U 16*		570765	174,33
	U 18*		570770	174,33
	U 20*		570775	174,33
	U 25*		570780	174,33
	U 32		570785	204,43
	U 40		570790	249,07
	U 63 (PZ-S)		572365	645,58
U 63 (PR-3B)	Z4	572837 R	733,81	

System	Pressing tongs / pressing rings	Driven by adapter tongs	Art.-No.	€
General Fittings Trident	H 16*		570320	168,10
	H 20*		570350	168,10
	H 26*		570370	168,10
	H 32		570380	168,10
	TH 16*		570460	186,32
	TH 20*		570470	186,32
	TH 26*		570475	186,32
	TH 32		570480	186,32
	TH 16 S (PR-2B)**	Z8	574782 R	124,51
	TH 20 S (PR-2B)**	Z8	574788 R	124,51
	TH 26 S (PR-2B)**	Z8	574794 R	124,51
	TH 32 S (PR-2B)	Z8	574798 R	136,96
General Fittings Trident Gas	U 16*		570765	174,33
	U 20*		570775	174,33
	U 32		570785	204,43
	TH 16*		570460	186,32
	TH 20*		570470	186,32
	TH 26*		570475	186,32
	TH 32		570480	186,32
	TH 16 S (PR-2B)**	Z8	574782 R	124,51
	TH 20 S (PR-2B)**	Z8	574788 R	124,51
	TH 26 S (PR-2B)**	Z8	574794 R	124,51
	TH 32 S (PR-2B)	Z8	574798 R	136,96
	Giacomini Raccordi RM Giacomini	H 16*		570320
H 20*			570350	168,10
H 26*			570370	168,10
H 32			570380	168,10
TH 16*			570460	186,32
TH 20*			570470	186,32
TH 26*			570475	186,32
TH 32			570480	186,32
TH 50 (PZ-S)			572400	645,58
TH 63 (PZ-S)			572405	645,58
U 16*			570765	174,33
U 20*			570775	174,33
Giacomini RM MULTIGAS	U 32		570785	204,43
	U 40		570790	249,07
	U 50		570795	298,89
	H 16*		570320	168,10
	H 20*		570350	168,10
	H 26*		570370	168,10
	H 32		570380	168,10
	TH 16*		570460	186,32
	TH 20*		570470	186,32
	TH 26*		570475	186,32
	TH 32		570480	186,32
	U 16*		570765	174,33
U 20*		570775	174,33	
U 32		570785	204,43	
U 40		570790	249,07	
U 50		570795	298,89	
Giacomini Valvole Giacomini serie R850V	U 32		570785	204,43
	U 40		570790	249,07
	V 15		570115	154,61
	V 18		570125	154,61
	V 22		570135	154,61
	V 28		570145	154,61
	V 35		570155	154,61
	V 42		570165	360,13
	V 54		570175	370,51
	V 15 S (PR-2B)	Z8	574752 R	124,51
	V 18 S (PR-2B)	Z8	574756 R	124,51
	V 22 S (PR-2B)	Z8	574758 R	124,51
V 28 S (PR-2B)	Z8	574760 R	124,51	
V 35 S (PR-2B)	Z8	574762 R	136,96	
SA 15		570935	185,75	
SA 18		570940	185,75	
SA 22		570945	185,75	
SA 28		570950	185,75	
SA 35		570955	185,75	
M 15		570110	154,61	
M 18		570120	154,61	
M 22		570130	154,61	
M 28		570140	154,61	
M 35		570150	154,61	
M 15 S (PR-2B)	Z8	574738 R	124,51	
M 18 S (PR-2B)	Z8	574740 R	124,51	
M 22 S (PR-2B)	Z8	574742 R	124,51	
M 28 S (PR-2B)	Z8	574744 R	124,51	
M 35 S (PR-2B)	Z8	574746 R	136,96	
Golan Pipe Systems (Scandinavia) Alu-Pres	U 16*		570765	174,33
	U 20*		570775	174,33
	U 25*		570780	174,33
	U 32		570785	204,43
	U 40		570790	249,07
	U 50		570795	298,89
	U 63 (PZ-S)		572365	645,58
U 63 (PR-3B)	Z4	572837 R	733,81	
U 75 (PR-3B)	Z4	572828 R	645,58	
Grinnell G-PRESS Copper Fittings	VUS ½" (OD 15,9 mm)		571770	186,79
	VUS ¾" (OD 22,2 mm)		571775	186,79
	VUS 1" (OD 28,6 mm)		571780	186,79
	VUS 1¼" (OD 34,9 mm)		571785	186,79
	VUS 1½" (OD 41,3 mm)		571790	360,13
	VUS 2" (OD 54,0 mm)		571795	370,51
	VUSFz 2½" (PR-3B) (OD 66,7 mm)	Z5	572819 R	609,25
	VUSFz 3" (PR-3B) (OD 79,4 mm)	Z5	572820 R	609,25
VUSFz 4" (PR-3B) (OD 104,8 mm)	Z5	572821 R	645,58	

**REMS pressing tongs**  
**REMS pressing rings**

Accessories for REMS radial presses (except for REMS Mini-Press) and suitable radial presses of other makes

System	Pressing tongs / pressing rings	Driven by adapter tongs	Art.-No.	€	System	Pressing tongs / pressing rings	Driven by adapter tongs	Art.-No.	€
GS Wärmesysteme System TH	TH 14*		570455	186,32	Herotec tempusPRESS PLUS	H 16*		570320	168,10
	TH 16*		570460	186,32		H 20*		570350	168,10
	TH 20*		570470	186,32		H 25*		570360	168,10
	TH 26*		570475	186,32		H 32		570380	168,10
	TH 32		570480	186,32		H 40 (PZ-4G)		570390	565,67
	TH 40		570485	246,99		RFz 16*		571325	194,05
	TH 50 (PZ-S)		572400	645,58		RFz 20*		571330	194,05
	TH 63 (PZ-S)		572405	645,58		RFz 25		571335	194,05
	TH 14 S (PR-2B)**	Z8	574778 R	124,51		RFz 32		571340	194,05
	TH 16 S (PR-2B)**	Z8	574782 R	124,51		TH 16*		570460	186,32
	TH 20 S (PR-2B)**	Z8	574788 R	124,51		TH 20*		570470	186,32
	TH 26 S (PR-2B)**	Z8	574794 R	124,51		TH 25*		570495	186,32
	TH 32 S (PR-2B)	Z8	574798 R	136,96		TH 32		570480	186,32
						TH 40		570485	246,99
	GS Wärmesysteme System V	V 15		570115		154,61	TH 50 (PZ-S)		572400
V 18			570125	154,61	TH 63 (PZ-S)		572405	645,58	
V 22			570135	154,61	TH 16 S (PR-2B)**	Z8	574782 R	124,51	
V 28			570145	154,61	TH 20 S (PR-2B)**	Z8	574788 R	124,51	
V 35			570155	154,61	TH 25 S (PR-2B)**	Z8	574792 R	124,51	
V 15 S (PR-2B)		Z8	574752 R	124,51	TH 32 S (PR-2B)	Z8	574798 R	136,96	
V 18 S (PR-2B)		Z8	574756 R	124,51	U 16*		570765	174,33	
V 22 S (PR-2B)		Z8	574758 R	124,51	U 20*		570775	174,33	
V 28 S (PR-2B)		Z8	574760 R	124,51	U 25*		570780	174,33	
V 35 S (PR-2B)		Z8	574762 R	136,96	U 32		570785	204,43	
					U 40		570790	249,07	
					U 50		570795	298,89	
					U 63 (PZ-S)		572365	645,58	
					U 63 (PR-3B)	Z4	572837 R	733,81	
					U 75 (PR-3B)	Z4	572828 R	645,58	
<b>H</b>					Herotec tempusPRESS PLUS PPSU	H 16*		570320	168,10
HASTINIK Hastinik/Hitpress	M 15		570110	154,61		H 20*		570350	168,10
	M 18		570120	154,61		H 25*		570380	168,10
	M 22		570130	154,61		TH 16*		570460	186,32
	M 28		570140	154,61		TH 20*		570495	186,32
	M 35		570150	154,61		TH 25*		570495	186,32
	M 42 (PZ-4G)		570160	498,19		TH 32		570480	186,32
	M 54 (PZ-4G)		570170	498,19		TH 40		570485	246,99
	M 42 (PR-3S)	Z2	572706 R	672,57		TH 50 (PZ-S)		572400	645,58
	M 54 (PR-3S)	Z2	572708 R	672,57		TH 63 (PZ-S)		572405	645,58
	M 76,1 XL (PR-3S)	Z6 XL <sup>3)</sup> / Z7 XL 45kN <sup>4)</sup>	579101 R	1.161,47		TH 16 S (PR-2B)**	Z8	574782 R	124,51
	M 88,9 G XL (PR-3S)	Z6 XL <sup>3)</sup> / Z7 XL 45kN <sup>4)</sup>	579110 R	1.355,58		TH 20 S (PR-2B)**	Z8	574788 R	124,51
	M 108,0 G XL (PR-3S)	Z6 XL <sup>3)</sup> / Z7 XL 45kN <sup>4)</sup>	579111 R	1.355,58		TH 25 S (PR-2B)**	Z8	574792 R	124,51
	M 15 S (PR-2B)	Z8	574738 R	124,51		TH 32 S (PR-2B)	Z8	574798 R	136,96
	M 18 S (PR-2B)	Z8	574740 R	124,51		U 16*		570765	174,33
	M 22 S (PR-2B)	Z8	574742 R	124,51	U 20*		570775	174,33	
M 28 S (PR-2B)	Z8	574744 R	124,51	U 25*		570780	174,33		
M 35 S (PR-2B)	Z8	574746 R	136,96	U 32		570785	204,43		
heima24	TH 16*		570460	186,32	U 40		570790	249,07	
	TH 20*		570470	186,32	U 50		570795	298,89	
	TH 26*		570475	186,32	U 63 (PR-3B)	Z4	572837 R	733,81	
	TH 32		570480	186,32	U 63 (PZ-S)		572365	645,58	
	TH 40		570485	246,99	U 75 (PR-3B)	Z4	572828 R	645,58	
	TH 50 (PZ-S)		572400	645,58	HERZ PIPEFIX	TH 10*	570467	186,32	
	TH 63 (PZ-S)		572405	645,58	TH 16*		570460	186,32	
	TH 16 S (PR-2B)**	Z8	574782 R	124,51	TH 20*		570470	186,32	
	TH 20 S (PR-2B)**	Z8	574788 R	124,51	TH 26*		570475	186,32	
	TH 26 S (PR-2B)**	Z8	574794 R	124,51	TH 32		570480	186,32	
	TH 32 S (PR-2B)	Z8	574798 R	136,96	TH 40		570485	246,99	
	U 16*		570765	174,33	TH 50 (PZ-S)		572400	645,58	
	U 20*		570775	174,33	TH 63 (PZ-S)		572405	645,58	
	U 32		570785	204,43	THz 75 (PR-3B)	Z4	572829 R	609,25	
	HELIROMA Klimapress	U 16*		570765	174,33	TH 10 S (PR-2B)**	Z8	574772 R	124,51
U 20*			570775	174,33	TH 16 S (PR-2B)**	Z8	574782 R	124,51	
U 25*			570780	174,33	TH 20 S (PR-2B)**	Z8	574788 R	124,51	
U 32			570785	204,43	TH 26 S (PR-2B)**	Z8	574794 R	124,51	
U 40			570790	249,07	TH 32 S (PR-2B)**	Z8	574798 R	136,96	
HELIROMA Klimapress PPSU	U 50		570795	298,89	HIDRONIX MULTIGAS	TH 16*		570460	186,32
	U 63 (PR-3B)	Z4	572837 R	733,81		TH 20*		570470	186,32
	U 63 (PZ-S)		572365	645,58		TH 26*		570475	186,32
	U 75 (PR-3B)	Z4	572828 R	645,58					
Henco	U 16*		570765	174,33					
	U 20*		570775	174,33					
	U 25*		570780	174,33					
	U 32		570785	204,43					
	TH 14*		570455	186,32					
TH 16*		570460	186,32						
TH 18*		570465	186,32						
TH 20*		570470	186,32						
TH 26*		570475	186,32						
HE 32		571900	223,12						
HEz 40		571904	323,80						

Pressfitting systems for gas installations must only be pressed with pressing tongs/pressing rings which are highlighted in yellow. Observe the national regulations. Read and observe the instructions for use and the installation instructions of the system provider/manufacturer.

- \* Can also be driven by the REMS Eco-Press manual radial press, see page 185. Observe the national regulations.
- \*\* Can also be driven by the REMS Eco-Press manual radial press using the Z8 adapter tongs, see page 185. Observe the national regulations.
- 1) Only pressing tongs from designation "108" (1<sup>st</sup> quarter of 2008), "208" (2<sup>nd</sup> quarter of 2008) etc. can be used. The designation is stamped on every pressing jaw.
- 2) For this pressfitting system producing a pressing joint with manual radial presses is not permitted.
- 3) Driven by REMS Power-Press XL ACC, see page 188.
- 4) Driven by REMS Akku-Press XL 45 kN 22V ACC, see page 196.
- 5) For taking suitable pressing inserts.
- 6) Press fittings made of red bronze (Sanpress XL) must be pressed with pressing rings with press contour VR, copper fittings (Profipress XL, Profipress G XL), carbon steel (Prestabo XL) and stainless steel fittings (Sanpress Inox XL, Sanpress Inox G XL) with pressing rings with press contour VF.
- 7) Use pressing rings labelled "M 88.9 G" or "M 108 G" on the three pressing segments for gas installations.
- 8) For making press joints for operating pressure ≤ PN 10.
- 9) For pipes of the EN technical standard. Observe the instructions for use of the system provider/manufacturer.
- 10) For pipes of the ASTM technical standard. Observe the instructions for use of the system provider/manufacturer.
- 11) Only use pressing tongs identified by "VMP ½" G" on the pressing jaws for gas installations.
- 12) Previous designation: C 26 pressing tongs

The suitability of REMS pressing tools for pressfitting systems: Date 27.10.2023. For the updated situation regarding suitability status check our website: [www.rems.de](http://www.rems.de) > Downloads > Product catalogues, brochures > REMS Catalogue. See page 238 for adapter tongs. Pressing tongs/pressing rings for additional pressfitting systems on request.

# REMS pressing tongs REMS pressing rings

Accessories for REMS radial presses (except for REMS Mini-Press) and suitable radial presses of other makes

System	Pressing tongs / pressing rings	Driven by adapter tongs	Art.-No.	€	
HIDRONIX MULTIPIPE	TH 14*		570455	186,32	
	TH 16*		570460	186,32	
	TH 20*		570470	186,32	
	TH 26*		570475	186,32	
	H 32		570480	186,32	
	H 14*		570310	168,10	
	H 16*		570320	168,10	
	H 18*		570340	168,10	
	H 20*		570350	168,10	
	H 26*		570370	168,10	
	H 32		570380	168,10	
	U 14*		570760	174,33	
	U 16*		570765	174,33	
	U 18*		570770	174,33	
	U 20*		570775	174,33	
	U 26* <sup>12)</sup>		570750	204,43	
	U 32		570785	204,43	
	HIDRONIX UNICO	TH 14*		570455	186,32
		TH 16*		570460	186,32
		TH 20*		570470	186,32
TH 26*			570475	186,32	
H 32			570480	186,32	
H 14*			570310	168,10	
H 16*			570320	168,10	
H 18*			570340	168,10	
H 20*			570350	168,10	
H 26*			570370	168,10	
H 32			570380	168,10	
U 14*			570760	174,33	
U 16*			570765	174,33	
U 18*			570770	174,33	
U 20*			570775	174,33	
U 26* <sup>12)</sup>			570750	204,43	
U 32			570785	204,43	
HITEC Sistema Multistrato		TH 14*		570455	186,32
		TH 16*		570460	186,32
		TH 18*		570465	186,32
	TH 20*		570470	186,32	
	TH 26*		570475	186,32	
	TH 32		570480	186,32	
	TH 40		570485	246,99	
	TH 50 (PZ-S)		572400	645,58	
	TH 14 S (PR-2B)**	Z8	574778 R	124,51	
	TH 16 S (PR-2B)**	Z8	574782 R	124,51	
	TH 18 S (PR-2B)**	Z8	574786 R	124,51	
	TH 20 S (PR-2B)**	Z8	574788 R	124,51	
	TH 26 S (PR-2B)**	Z8	574794 R	124,51	
	TH 32 S (PR-2B)**	Z8	574798 R	136,96	
	HITHERM-ISOTUBI NUMEPRESS	M 15		570110	154,61
		M 18		570120	154,61
		M 22		570130	154,61
		M 28		570140	154,61
M 35			570150	154,61	
M 42 (PR-3S)		Z2	572706 R	672,57	
M 54 (PR-3S)		Z2	572708 R	672,57	
M 76,1 XL (PR-3S)		Z6 XL <sup>3)</sup> / Z7 XL 45 kN <sup>4)</sup>	579101 R	1.161,47	
M 88,9 G XL (PR-3S)		Z6 XL <sup>3)</sup> / Z7 XL 45 kN <sup>4)</sup>	579110 R	1.355,58	
M 108,0 G XL (PR-3S)		Z6 XL <sup>3)</sup> / Z7 XL 45 kN <sup>4)</sup>	579111 R	1.355,58	
M 15 S (PR-2B)		Z8	574738 R	124,51	
M 18 S (PR-2B)		Z8	574740 R	124,51	
M 22 S (PR-2B)		Z8	574742 R	124,51	
M 28 S (PR-2B)		Z8	574744 R	124,51	
M 35 S (PR-2B)		Z8	574746 R	136,96	
HITHERM HTpress		M 15		570110	154,61
		M 18		570120	154,61
		M 22		570130	154,61
		M 28		570140	154,61
		M 35		570150	154,61
		M 42 (PR-3S)	Z2	572706 R	672,57
		M 54 (PR-3S)	Z2	572708 R	672,57
	M 76,1 XL (PR-3S)	Z6 XL <sup>3)</sup> / Z7 XL 45 kN <sup>4)</sup>	579101 R	1.161,47	
	M 88,9 G XL (PR-3S)	Z6 XL <sup>3)</sup> / Z7 XL 45 kN <sup>4)</sup>	579110 R	1.355,58	
	M 108,0 G XL (PR-3S)	Z6 XL <sup>3)</sup> / Z7 XL 45 kN <sup>4)</sup>	579111 R	1.355,58	
	M 15 S (PR-2B)	Z8	574738 R	124,51	
	M 18 S (PR-2B)	Z8	574740 R	124,51	
	M 22 S (PR-2B)	Z8	574742 R	124,51	
	M 28 S (PR-2B)	Z8	574744 R	124,51	
	M 35 S (PR-2B)	Z8	574746 R	136,96	
	HITHERM HTfire	M 15		570110	154,61
		M 18		570120	154,61
		M 22		570130	154,61
		M 28		570140	154,61
		M 35		570150	154,61
M 42 (PR-3S)		Z2	572706 R	672,57	
M 54 (PR-3S)		Z2	572708 R	672,57	
M 76,1 XL (PR-3S)		Z6 XL <sup>3)</sup> / Z7 XL 45 kN <sup>4)</sup>	579101 R	1.161,47	
M 88,9 G XL (PR-3S)		Z6 XL <sup>3)</sup> / Z7 XL 45 kN <sup>4)</sup>	579110 R	1.355,58	
M 108,0 G XL (PR-3S)		Z6 XL <sup>3)</sup> / Z7 XL 45 kN <sup>4)</sup>	579111 R	1.355,58	
M 15 S (PR-2B)		Z8	574738 R	124,51	
M 18 S (PR-2B)		Z8	574740 R	124,51	
M 22 S (PR-2B)		Z8	574742 R	124,51	
M 28 S (PR-2B)		Z8	574744 R	124,51	
M 35 S (PR-2B)		Z8	574746 R	136,96	

System	Pressing tongs / pressing rings	Driven by adapter tongs	Art.-No.	€	
HITHERM HTair	M 15		570110	154,61	
	M 18		570120	154,61	
	M 22		570130	154,61	
	M 28		570140	154,61	
	M 35		570150	154,61	
	M 42 (PR-3S)	Z2	572706 R	672,57	
	M 54 (PR-3S)	Z2	572708 R	672,57	
	M 76,1 XL (PR-3S)	Z6 XL <sup>3)</sup> / Z7 XL 45 kN <sup>4)</sup>	579101 R	1.161,47	
	M 88,9 G XL (PR-3S)	Z6 XL <sup>3)</sup> / Z7 XL 45 kN <sup>4)</sup>	579110 R	1.355,58	
	M 108,0 G XL (PR-3S)	Z6 XL <sup>3)</sup> / Z7 XL 45 kN <sup>4)</sup>	579111 R	1.355,58	
	M 15 S (PR-2B)	Z8	574738 R	124,51	
	M 18 S (PR-2B)	Z8	574740 R	124,51	
	M 22 S (PR-2B)	Z8	574742 R	124,51	
	M 28 S (PR-2B)	Z8	574744 R	124,51	
	M 35 S (PR-2B)	Z8	574746 R	136,96	
	Hopewell press fit system	M 15		570110	154,61
		M 18		570120	154,61
		M 22		570130	154,61
		M 28		570140	154,61
		M 35		570150	154,61
		M 42 (PZ-4G)		570160	498,19
		M 54 (PZ-4G)		570170	498,19
	M 42 (PR-3S)	Z2	572706 R	672,57	
	M 54 (PR-3S)	Z2	572708 R	672,57	
	hp praski BAVARIA-press	TH 10*		570467	186,32
		TH 12*		570452	186,32
TH 14*			570455	186,32	
TH 16*			570460	186,32	
TH 17*			570462	186,32	
TH 20*			570470	186,32	
TH 25*			570495	186,32	
TH 26*			570475	186,32	
TH 32			570480	186,32	
TH 40			570485	246,99	
TH 10 S (PR-2B)**		Z8	574772 R	124,51	
TH 12 S (PR-2B)**		Z8	574776 R	124,51	
TH 14 S (PR-2B)**		Z8	574778 R	124,51	
TH 16 S (PR-2B)**		Z8	574782 R	124,51	
TH 17 S (PR-2B)**	Z8	574784 R	124,51		
TH 20 S (PR-2B)**	Z8	574788 R	124,51		
TH 25 S (PR-2B)**	Z8	574792 R	124,51		
TH 26 S (PR-2B)**	Z8	574794 R	124,51		
TH 32 S (PR-2B)	Z8	574798 R	136,96		
ICMA Sempiter	H 16*		570320	168,10	
	H 20*		570350	168,10	
	H 25*		570360	168,10	
	H 26*		570370	168,10	
	H 32		570380	168,10	
	H 40 (PZ-4G)		570390	565,67	
	TH 16*		570460	186,32	
	TH 20*		570470	186,32	
	TH 25*		570495	186,32	
	TH 26*		570475	186,32	
	TH 32		570480	186,32	
	TH 40		570485	246,99	
	TH 50 (PZ-S)		572400	645,58	
	TH 63 (PZ-S)		572405	645,58	
	TH 16 S (PR-2B)**	Z8	574782 R	124,51	
	TH 20 S (PR-2B)**	Z8	574788 R	124,51	
	TH 26 S (PR-2B)**	Z8	574794 R	124,51	
	TH 32 S (PR-2B)	Z8	574798 R	136,96	
	U 16*		570765	174,33	
	U 20*		570775	174,33	
	U 25*		570780	174,33	
	U 26* <sup>12)</sup>		570750	204,43	
U 32		570785	204,43		
U 40		570790	249,07		
U 50		570795	298,89		
U 63 (PR-3B)	Z4	572837 R	733,81		
U 63 (PZ-S)		572365	645,58		
ICMA Sempigas	TH 16*		570460	186,32	
	TH 20*		570470	186,32	
	TH 25*		570495	186,32	
	TH 26*		570475	186,32	
	TH 32		570480	186,32	
	TH 16 S (PR-2B)**	Z8	574782 R	124,51	
	TH 20 S (PR-2B)**	Z8	574788 R	124,51	
	TH 26 S (PR-2B)**	Z8	574794 R	124,51	
	TH 32 S (PR-2B)	Z8	574798 R	136,96	
Idrosanitaria Bonomi	TH 16*		570460	186,32	
	TH 20*		570470	186,32	
	Homegas	TH 26*		570475	186,32
		TH 16 S (PR-2B)**	Z8	574782 R	124,51
TH 20 S (PR-2B)**		Z8	574788 R	124,51	
TH 26 S (PR-2B)**	Z8	574794 R	124,51		
Idrosanitaria Bonomi Idropress	TH 16*		570460	186,32	
	TH 18*		570465	186,32	
	TH 20*		570470	186,32	
	TH 26*		570475	186,32	
	TH 32		570480	186,32	
	TH 40		570485	246,99	
	TH 50 (PZ-S)		572400	645,58	
	TH 63 (PZ-S)		572405	645,58	
	TH 16 S (PR-2B)**	Z8	574782 R	124,51	
	TH 20 S (PR-2B)**	Z8	574788 R	124,51	
	TH 26 S (PR-2B)**	Z8	574794 R	124,51	
TH 32 S (PR-2B)	Z8	574798 R	136,96		



# REMS pressing tongs REMS pressing rings

Accessories for REMS radial presses (except for REMS Mini-Press)  
and suitable radial presses of other makes

System	Pressing tongs/ pressing rings	Driven by adapter tongs	Art.-No.	€	System	Pressing tongs/ pressing rings	Driven by adapter tongs	Art.-No.	€	
IDROSISTEMI Ta-Press	TH 16*		570460	186,32	IDROTRADE StormSTEEL <sup>1)</sup>	M 12		570100	154,61	
	TH 20*		570470	186,32		M 15		570110	154,61	
	TH 26*		570475	186,32		M 18		570120	154,61	
	TH 32		570480	186,32		M 22		570130	154,61	
	TH 40		570485	246,99		M 28		570140	154,61	
	TH 50 (PZ-S)		572400	645,58		M 35		570150	154,61	
	TH 63 (PZ-S)		572405	645,58		M 42 (PR-3S)	Z2	572706 R	672,57	
	TH 16 S (PR-2B)**	Z8	574782 R	124,51		M 54 (PR-3S)	Z2	572708 R	672,57	
	TH 20 S (PR-2B)**	Z8	574788 R	124,51		M 76,1 XL (PR-3S) <sup>8)</sup>	Z7 XL 45 kN <sup>4)</sup>	579101 R	1.161,47	
	TH 26 S (PR-2B)**	Z8	574794 R	124,51		M 88,9 G XL (PR-3S) <sup>8)</sup>	Z7 XL 45 kN <sup>4)</sup>	579110 R	1.355,58	
	TH 32 S (PR-2B)	Z8	574798 R	136,96		M 108,0 G XL (PR-3S) <sup>8)</sup>	Z7 XL 45 kN <sup>4)</sup>	579111 R	1.355,58	
	F 16*		570717	177,45		M 12 S (PR-2B)	Z8	574736 R	124,51	
	F 20*		570727	177,45		M 15 S (PR-2B)	Z8	574738 R	124,51	
	F 26*		570730	191,98		M 18 S (PR-2B)	Z8	574740 R	124,51	
	F 32		570735	191,98		M 22 S (PR-2B)	Z8	574742 R	124,51	
	F 16 S (PR-2B)**	Z8	574728 R	124,51		M 28 S (PR-2B)	Z8	574744 R	124,51	
	F 20 S (PR-2B)**	Z8	574730 R	124,51		M 35 S (PR-2B)	Z8	574746 R	136,96	
	F 26 S (PR-2B)**	Z8	574732 R	124,51		ILTA	M 15	570110	154,61	
	F 32 S (PR-2B)	Z8	574734 R	136,96		INOX/CHIBRO	M 18	570120	154,61	
	Fz 40		570742	205,47		Pressfitting Cuni	M 22	570130	154,61	
	Fz 50		570747	311,35		M 28		570140	154,61	
	F 63 (PZ-S)		572385	645,58		M 35		570150	154,61	
	H 16*		570320	168,10		M 42 (PR-3S)	Z2	572706 R	672,57	
	H 20*		570350	168,10		M 54 (PR-3S)	Z2	572708 R	672,57	
	H 26*		570370	168,10		M 76,1 XL (PR-3S)	Z6 XL <sup>3)</sup> / Z7 XL 45 kN <sup>4)</sup>	579101 R	1.161,47	
	H 32		570380	168,10		M 88,9 G XL (PR-3S)	Z6 XL <sup>3)</sup> / Z7 XL 45 kN <sup>4)</sup>	579110 R	1.355,58	
	H 40 (PZ-46)		570390	565,67		M 108,0 G XL (PR-3S)	Z6 XL <sup>3)</sup> / Z7 XL 45 kN <sup>4)</sup>	579111 R	1.355,58	
	U 16*		570765	174,33		M 15 S (PR-2B)	Z8	574738 R	124,51	
	U 20*		570775	174,33		M 18 S (PR-2B)	Z8	574740 R	124,51	
	U 26* <sup>12)</sup>		570750	204,43		M 22 S (PR-2B)	Z8	574742 R	124,51	
	U 32		570785	204,43		M 28 S (PR-2B)	Z8	574744 R	124,51	
	U 40		570790	249,07		M 35 S (PR-2B)	Z8	574746 R	136,96	
	U 50		570795	298,89		ILTA	M 15	570110	154,61	
	U 63 (PZ-S)		572365	645,58		INOX/CHIBRO	M 18	570120	154,61	
	B 16*		570850	203,40		Pressfitting inox	M 22	570130	154,61	
	B 20*		570860	203,40		M 28		570140	154,61	
	B 26		570870	224,16		M 35		570150	154,61	
	B 32		570880	224,16		M 42 (PR-3S)	Z2	572706 R	672,57	
	IDROTRADE Storm Multipinza	H 16*		570320		168,10	M 54 (PR-3S)	Z2	572708 R	672,57
		H 20*		570350		168,10	M 76,1 XL (PR-3S)	Z6 XL <sup>3)</sup> / Z7 XL 45 kN <sup>4)</sup>	579101 R	1.161,47
		H 26*		570370		168,10	M 88,9 G XL (PR-3S)	Z6 XL <sup>3)</sup> / Z7 XL 45 kN <sup>4)</sup>	579110 R	1.355,58
		H 32		570380		168,10	M 108,0 G XL (PR-3S)	Z6 XL <sup>3)</sup> / Z7 XL 45 kN <sup>4)</sup>	579111 R	1.355,58
		TH 16*		570460		186,32	M 15 S (PR-2B)	Z8	574738 R	124,51
		TH 20*		570470		186,32	M 18 S (PR-2B)	Z8	574740 R	124,51
		TH 26*		570475		186,32	M 22 S (PR-2B)	Z8	574742 R	124,51
		TH 32		570480		186,32	M 28 S (PR-2B)	Z8	574744 R	124,51
		THL 32		570487		186,32	M 35 S (PR-2B)	Z8	574746 R	136,96
		TH 40		570485		246,99	Instantor Press System	TH 16*	570460	186,32
		TH 50 (PZ-S)		572400		645,58	TH 20*	570470	186,32	
		TH 63 (PZ-S)		572405		645,58	TH 26*	570475	186,32	
		TH 16 S (PR-2B)**	Z8	574782 R		124,51	TH 32	570480	186,32	
		TH 20 S (PR-2B)**	Z8	574788 R		124,51	TH 16 S (PR-2B)**	Z8	574782 R	124,51
TH 26 S (PR-2B)**		Z8	574794 R	124,51	TH 20 S (PR-2B)**	Z8	574788 R	124,51		
TH 32 S (PR-2B)		Z8	574798 R	136,96	TH 26 S (PR-2B)**	Z8	574794 R	124,51		
U 16*			570765	174,33	TH 32 S (PR-2B)	Z8	574798 R	136,96		
U 20*			570775	174,33	Instantor	VI ½" S (PR-2B)	574850 R	124,51		
IDROTRADE StormPRES <sup>1)</sup>		M 15		570110	154,61	Copper Press Imperial	VI ¾" S (PR-2B)	574852 R	124,51	
	M 18		570120	154,61	VI 1" S (PR-2B)	574854 R	124,51			
	M 22		570130	154,61	Instantor	M 15	570110	154,61		
	M 28		570140	154,61	Copper Press Metric	M 22	570130	154,61		
	M 35		570150	154,61	M 28		570140	154,61		
	M 42 (PR-3S)	Z2	572706 R	672,57	M 15 S (PR-2B)	Z8	574738 R	124,51		
	M 54 (PR-3S)	Z2	572708 R	672,57	M 22 S (PR-2B)	Z8	574742 R	124,51		
	M 76,1 XL (PR-3S) <sup>8)</sup>	Z7 XL 45 kN <sup>4)</sup>	579101 R	1.161,47	M 28 S (PR-2B)	Z8	574744 R	124,51		
	M 88,9 G XL (PR-3S) <sup>8)</sup>	Z7 XL 45 kN <sup>4)</sup>	579110 R	1.355,58	M 35 S (PR-2B)	Z8	574746 R	136,96		
	M 108,0 G XL (PR-3S) <sup>8)</sup>	Z7 XL 45 kN <sup>4)</sup>	579111 R	1.355,58						
	M 15 S (PR-2B)	Z8	574738 R	124,51						
	M 18 S (PR-2B)	Z8	574740 R	124,51						
	M 22 S (PR-2B)	Z8	574742 R	124,51						
	M 28 S (PR-2B)	Z8	574744 R	124,51						
	M 35 S (PR-2B)	Z8	574746 R	136,96						

Pressfitting systems for gas installations must only be pressed with pressing tongs/pressing rings which are highlighted in yellow.

Observe the national regulations. Read and observe the instructions for use and the installation instructions of the system provider/manufacturer.

\* Can also be driven by the REMS Eco-Press manual radial press, see page 185. Observe the national regulations.

\*\* Can also be driven by the REMS Eco-Press manual radial press using the Z8 adapter tongs, see page 185. Observe the national regulations.

<sup>1)</sup> Only pressing tongs from designation "108" (1<sup>st</sup> quarter of 2008), "208" (2<sup>nd</sup> quarter of 2008) etc. can be used. The designation is stamped on every pressing jaw.

<sup>2)</sup> For this pressfitting system producing a pressing joint with manual radial presses is not permitted.

<sup>3)</sup> Driven by REMS Power-Press XL ACC, see page 188.

<sup>4)</sup> Driven by REMS Akku-Press XL 45 kN 22V ACC, see page 196.

<sup>5)</sup> For taking suitable pressing inserts.

<sup>6)</sup> Press fittings made of red bronze (Sanpress XL) must be pressed with pressing rings with press contour VR, copper fittings (Profipress XL, Profipress G XL), carbon steel (Prestabo XL) and stainless steel fittings (Sanpress Inox XL, Sanpress Inox G XL) with pressing rings with press contour VF.

<sup>7)</sup> Use pressing rings labelled "M 88.9 G" or "M 108 G" on the three pressing segments for gas installations.

<sup>8)</sup> For making press joints for operating pressure ≤ PN 10.

<sup>9)</sup> For pipes of the EN technical standard. Observe the instructions for use of the system provider/manufacturer.

<sup>10)</sup> For pipes of the ASTM technical standard. Observe the instructions for use of the system provider/manufacturer.

<sup>11)</sup> Only use pressing tongs identified by "VMP ½" G" on the pressing jaws for gas installations.

<sup>12)</sup> Previous designation: C 26 pressing tongs

The suitability of REMS pressing tools for pressfitting systems: Date 27.10.2023. For the updated situation regarding suitability status check our website: [www.rems.de](http://www.rems.de) > Downloads > Product catalogues, brochures > REMS Catalogue.

See page 238 for adapter tongs. Pressing tongs/pressing rings for additional pressfitting systems on request.

System	Pressing tongs / pressing rings	Driven by adapter tongs	Art.-No.	€	
IPA IPANA Press	TH 10*		570467	186,32	
	TH 11,6*		570482	186,32	
	TH 12*		570452	186,32	
	TH 14*		570455	186,32	
	TH 15*		570457	186,32	
	TH 16*		570460	186,32	
	TH 17*		570462	186,32	
	TH 18*		570465	186,32	
	TH 20*		570470	186,32	
	TH 22*		570472	186,32	
	TH 25*		570495	186,32	
	TH 26*		570475	186,32	
	TH 28		570477	186,32	
	TH 32		570480	186,32	
	TH 40		570485	246,99	
	TH 50 (PZ-S)		572400	645,58	
	TH 63 (PZ-S)		572405	645,58	
	THz 75 (PR-3B)	Z4	572829 R	609,25	
	TH 10 S (PR-2B)**	Z8	574772 R	124,51	
	TH 11,6 S (PR-2B)**	Z8	574774 R	124,51	
	TH 12 S (PR-2B)**	Z8	574776 R	124,51	
	TH 14 S (PR-2B)**	Z8	574778 R	124,51	
	TH 15 S (PR-2B)**	Z8	574780 R	124,51	
	TH 16 S (PR-2B)**	Z8	574782 R	124,51	
	TH 17 S (PR-2B)**	Z8	574784 R	124,51	
	TH 18 S (PR-2B)**	Z8	574786 R	124,51	
	TH 20 S (PR-2B)**	Z8	574788 R	124,51	
	TH 22 S (PR-2B)**	Z8	574790 R	124,51	
	TH 25 S (PR-2B)**	Z8	574792 R	124,51	
	TH 26 S (PR-2B)**	Z8	574794 R	124,51	
	TH 28 S (PR-2B)**	Z8	574796 R	136,96	
	TH 32 S (PR-2B)**	Z8	574798 R	136,96	
	IPA THu IPANA Press	TH 16*		570460	186,32
		TH 20*		570470	186,32
		TH 26*		570475	186,32
TH 32			570480	186,32	
TH 40			570485	246,99	
TH 16 S (PR-2B)**		Z8	574782 R	124,51	
TH 20 S (PR-2B)**		Z8	574788 R	124,51	
TH 26 S (PR-2B)**		Z8	574794 R	124,51	
TH 32 S (PR-2B)	Z8	574798 R	136,96		
IPALPEX (Industrie du Plastique et Accessoires)	TH 14*		570455	186,32	
	TH 16*		570460	186,32	
	TH 18*		570465	186,32	
	TH 20*		570470	186,32	
	TH 26*		570475	186,32	
	THL 32		570487	186,32	
	TH 40		570485	246,99	
TH 50 (PZ-S)		572400	645,58		
TH 63 (PZ-S)		572405	645,58		
IPLEX PIPELINES AUSTRALIA Iplex Pro-fit	K16/P18*		572600	194,05	
	PF 22*		571980	209,62	
IPLEX PIPELINES AUSTRALIA Iplex K1 (Gas)	K16/P18*		572600	194,05	
	K/20*		572605	194,05	
	K/25*		572610	194,05	
	K32		572615	194,05	
	K1/40		572620	194,05	
	K1/50		572625	318,61	
IPLEX PIPELINES AUSTRALIA Iplex K2	K16/P18*		572600	194,05	
	K/20*		572605	194,05	
	K/25*		572610	194,05	
			572610	194,05	
ISOLTUBEX ISOLPEX IPERT	Rfz 16*		571325	194,05	
	Rfz 20*		571330	194,05	
	Rfz 25		571337	213,78	
	Rfz 32		571342	213,78	
			571325	194,05	
ISOLTUBEX Multicapra	Rfz 16*		571325	194,05	
	Rfz 18*		571327	194,05	
	Rfz 20*		571330	194,05	
	Rfz 25		571337	213,78	
	Rfz 32		571342	213,78	
	U 16*		570765	174,33	
	U 18*		570770	174,33	
	U 20*		570775	174,33	
	U 25*		570780	174,33	
	U 32		570785	204,43	
	U 40		570790	249,07	
	U 50		570795	298,89	
	U 63 (PR-3B)	Z4	572837 R	733,81	
	U 63 (PZ-S)		572365	645,58	
	ISOLTUBEX Multicapra GAS	Rfz 16*		571325	194,05
		Rfz 20*		571330	194,05
		Rfz 25		571337	213,78
		Rfz 32		571342	213,78
ISOLTUBEX Multicapra-PPSU	U 16*		570765	174,33	
	U 20*		570775	174,33	
	U 25*		570780	174,33	
	U 32		570785	204,43	
ISOTUBI NUMEPRESS	M 15		570110	154,61	
	M 18 <sup>1)</sup>		570120	154,61	
	M 22		570130	154,61	
	M 28 <sup>1)</sup>		570140	154,61	
	M 35		570150	154,61	
	M 42 (PR-3S)	Z2	572706 R	672,57	
	M 54 (PR-3S)	Z2	572708 R	672,57	
	M 76,1 XL (PR-3S)	Z6 XL <sup>2)</sup> / Z7 XL 45 kN <sup>4)</sup>	579101 R	1.161,47	
	M 88,9 G XL (PR-3S)	Z6 XL <sup>2)</sup> / Z7 XL 45 kN <sup>4)</sup>	579110 R	1.355,58	
	M 108,0 G XL (PR-3S)	Z6 XL <sup>2)</sup> / Z7 XL 45 kN <sup>4)</sup>	579111 R	1.355,58	
	M 15 S (PR-2B)	Z8	574738 R	124,51	
	M 18 S (PR-2B)	Z8	574740 R	124,51	
	M 22 S (PR-2B)	Z8	574742 R	124,51	
	M 28 S (PR-2B)	Z8	574744 R	124,51	
	M 35 S (PR-2B)	Z8	574746 R	136,96	

System	Pressing tongs / pressing rings	Driven by adapter tongs	Art.-No.	€	
IVAR ALPEX-GAS	B 20		570860	203,40	
	B 26		570870	224,16	
	B 32		570880	224,16	
IVAR Ivar-Press	B 14*		570845	203,40	
	B 16*		570850	203,40	
	B 18*		570855	203,40	
	B 20*		570860	203,40	
	B 26		570870	224,16	
	B 32		570880	224,16	
	Fz 40		570742	205,47	
	Fz 50		570747	311,35	
	F 63 (PZ-S)		572385	645,58	
	IVAR MULTI PRESS GAS ITALIA	TH 16*		570460	186,32
TH 20*			570470	186,32	
TH 26*			570475	186,32	
H 16*			570320	168,10	
H 20*			570350	168,10	
H 26*			570370	168,10	
U 16*			570765	174,33	
U 20*			570775	174,33	
IVAR Multi Press MP		TH 16*		570460	186,32
		TH 18*		570465	186,32
		TH 20*		570470	186,32
		TH 25*		570495	186,32
		TH 26*		570475	186,32
		TH 32		570480	186,32
		TH 40		570485	246,99
	TH 50 (PZ-S)		572400	645,58	
	TH 63 (PZ-S)		572405	645,58	
	TH 16 S (PR-2B)**	Z8	574782 R	124,51	
	TH 18 S (PR-2B)**	Z8	574786 R	124,51	
	TH 20 S (PR-2B)**	Z8	574788 R	124,51	
	TH 25 S (PR-2B)**	Z8	574792 R	124,51	
	TH 26 S (PR-2B)**	Z8	574794 R	124,51	
	TH 32 S (PR-2B)	Z8	574798 R	136,96	
F 16*		570717	177,45		
F 18*		570720	177,45		
F 20*		570727	177,45		
F 26*		570730	191,98		
F 32		570735	191,98		
Fz 40		570742	205,47		
Fz 50		570747	311,35		
F 63 (PZ-S)		572385	645,58		
F 16 S (PR-2B)**	Z8	574728 R	124,51		
F 20 S (PR-2B)**	Z8	574730 R	124,51		
F 26 S (PR-2B)**	Z8	574732 R	124,51		
F 32 S (PR-2B)	Z8	574734 R	136,96		
H 16*		570320	168,10		
H 18*		570340	168,10		
H 20*		570350	168,10		
H 25*		570360	168,10		
H 26*		570370	168,10		
H 32		570380	168,10		
H 40 (PZ-46)		570390	565,67		
U 16*		570765	174,33		
U 18*		570770	174,33		
U 20*		570775	174,33		
U 25*		570780	174,33		
U 26* <sup>12)</sup>		570750	204,43		
U 32		570785	204,43		
U 40		570790	249,07		
U 50		570795	298,89		
U 63 (PZ-S)		572365	645,58		
B 16*		570850	203,40		
B 18*		570855	203,40		
B 20*		570860	203,40		
B 26		570870	224,16		
B 32		570880	224,16		
IVAR Multi Press Leak (MPL)	TH 16*		570460	186,32	
	TH 20*		570470	186,32	
	TH 26*		570475	186,32	
	TH 32		570480	186,32	
	TH 16 S (PR-2B)**	Z8	574782 R	124,51	
	TH 20 S (PR-2B)**	Z8	574788 R	124,51	
	TH 26 S (PR-2B)**	Z8	574794 R	124,51	
	TH 32 S (PR-2B)	Z8	574798 R	136,96	
	F 16*		570717	177,45	
	F 20*		570727	177,45	
	F 26*		570730	191,98	
	F 32		570735	191,98	
	F 16 S (PR-2B)**	Z8	574728 R	124,51	
	F 20 S (PR-2B)**	Z8	574730 R	124,51	
	F 26 S (PR-2B)**	Z8	574732 R	124,51	
F 32 S (PR-2B)	Z8	574734 R	136,96		
H 16*		570320	168,10		
H 20*		570350	168,10		
H 26*		570370	168,10		
H 32		570380	168,10		
U 16*		570765	174,33		
U 20*		570775	174,33		
U 26* <sup>12)</sup>		570750	204,43		
U 32		570785	204,43		
B 16*		570850	203,40		
B 20*		570860	203,40		
B 26		570870	224,16		
B 32		570880	224,16		

**REMS pressing tongs**  
**REMS pressing rings**

Accessories for REMS radial presses (except for REMS Mini-Press)  
and suitable radial presses of other makes

System	Pressing tongs/ pressing rings	Driven by adapter tongs	Art.-No.	€	System	Pressing tongs/ pressing rings	Driven by adapter tongs	Art.-No.	€		
IVAR Plastic Multi Press Leak (PMPL)	TH 16*		570460	186,32	IVT PRIPRESS	TH 16*		570460	186,32		
	TH 20*		570470	186,32		TH 20*		570470	186,32		
	TH 26*		570475	186,32		TH 26*		570475	186,32		
	TH 32		570480	186,32		TH 32		570480	186,32		
	TH 16 S (PR-2B)**	Z8	574782 R	124,51		TH 40		570485	246,99		
	TH 20 S (PR-2B)**	Z8	574788 R	124,51		TH 16 S (PR-2B)**	Z8	574782 R	124,51		
	TH 26 S (PR-2B)**	Z8	574794 R	124,51		TH 20 S (PR-2B)**	Z8	574788 R	124,51		
	TH 32 S (PR-2B)	Z8	574798 R	136,96		TH 26 S (PR-2B)**	Z8	574794 R	124,51		
	F 16*		570717	177,45		TH 32 S (PR-2B)	Z8	574798 R	136,96		
	F 20*		570727	177,45		<b>J</b>					
	F 26*		570730	191,98		Jäger - Aquatec	H 14*		570310	168,10	
	F 32		570735	191,98		Aquapress H	H 16*		570320	168,10	
	F 16 S (PR-2B)**	Z8	574728 R	124,51			H 17*		570330	168,10	
	F 20 S (PR-2B)**	Z8	574730 R	124,51			H 18*		570340	168,10	
	F 26 S (PR-2B)**	Z8	574732 R	124,51			H 20*		570350	168,10	
	F 32 S (PR-2B)	Z8	574734 R	136,96			H 26*		570370	168,10	
	H 16*		570320	168,10			H 32		570380	168,10	
	H 20*		570350	168,10			U 40		570790	249,07	
	H 26*		570370	168,10			U 50		570795	298,89	
	H 32		570380	168,10			U 63 (PZ-S)		572365	645,58	
	U 16*		570765	174,33		Jäger - Aquatec	M 15		570110	154,61	
	U 20*		570775	174,33		C-Stahl - Press Typ M	M 18		570120	154,61	
	U 26* <sup>12)</sup>		570750	204,43			M 22		570130	154,61	
	U 32		570785	204,43			M 28		570140	154,61	
	B 16*		570850	203,40			M 35		570150	154,61	
	B 20*		570860	203,40			M 42 (PR-3S)	Z2	572706 R	672,57	
	B 26		570870	224,16			M 54 (PR-3S)	Z2	572708 R	672,57	
	B 32		570880	224,16			M 76,1 XL (PR-3S)	Z6 XL <sup>3)</sup> / Z7 XL 45 kN <sup>4)</sup>	579101 R	1.161,47	
	IVAR	TH 16*		570460		186,32	M 88,9 G XL (PR-3S)	Z6 XL <sup>3)</sup> / Z7 XL 45 kN <sup>4)</sup>	579110 R	1.355,58	
	Plastic Multi Press PMP	TH 20*		570470		186,32	M 108,0 G XL (PR-3S)	Z6 XL <sup>3)</sup> / Z7 XL 45 kN <sup>4)</sup>	579111 R	1.355,58	
		TH 25*		570495		186,32	M 15 S (PR-2B)	Z8	574738 R	124,51	
		TH 26*		570475		186,32	M 18 S (PR-2B)	Z8	574740 R	124,51	
		TH 32		570480		186,32	M 22 S (PR-2B)	Z8	574742 R	124,51	
		TH 16 S (PR-2B)**	Z8	574782 R		124,51	M 28 S (PR-2B)	Z8	574744 R	124,51	
		TH 20 S (PR-2B)**	Z8	574788 R		124,51	M 35 S (PR-2B)	Z8	574746 R	136,96	
		TH 25 S (PR-2B)**	Z8	574792 R		124,51	Jäger - Aquatec	M 15		570110	154,61
		TH 26 S (PR-2B)**	Z8	574794 R		124,51	Edelstahl - Press Typ M	M 18		570120	154,61
		TH 32 S (PR-2B)	Z8	574798 R		136,96		M 22		570130	154,61
		F 16*		570717		177,45		M 28		570140	154,61
		F 20*		570727		177,45		M 35		570150	154,61
		F 26*		570730		191,98		M 42 (PR-3S)	Z2	572706 R	672,57
		F 32		570735		191,98		M 54 (PR-3S)	Z2	572708 R	672,57
F 16 S (PR-2B)**		Z8	574728 R	124,51		M 76,1 XL (PR-3S)	Z6 XL <sup>3)</sup> / Z7 XL 45 kN <sup>4)</sup>	579101 R	1.161,47		
F 20 S (PR-2B)**		Z8	574730 R	124,51		M 88,9 G XL (PR-3S)	Z6 XL <sup>3)</sup> / Z7 XL 45 kN <sup>4)</sup>	579110 R	1.355,58		
F 26 S (PR-2B)**		Z8	574732 R	124,51		M 108,0 G XL (PR-3S)	Z6 XL <sup>3)</sup> / Z7 XL 45 kN <sup>4)</sup>	579111 R	1.355,58		
F 32 S (PR-2B)		Z8	574734 R	136,96		M 15 S (PR-2B)	Z8	574738 R	124,51		
H 16*			570320	168,10		M 18 S (PR-2B)	Z8	574740 R	124,51		
H 20*			570350	168,10		M 22 S (PR-2B)	Z8	574742 R	124,51		
H 25*			570360	168,10		M 28 S (PR-2B)	Z8	574744 R	124,51		
H 26*			570370	168,10		M 35 S (PR-2B)	Z8	574746 R	136,96		
H 32			570380	168,10	Jäger - Aquatec	V 15		570115	154,61		
U 16*			570765	174,33	Kupfer - Press Typ V	V 18		570125	154,61		
U 20*			570775	174,33		V 22		570135	154,61		
U 25*			570780	174,33		V 28		570145	154,61		
U 26* <sup>12)</sup>			570750	204,43		V 35		570155	154,61		
U 32			570785	204,43		V 42		570165	360,13		
B 16*			570850	203,40		V 42 (PR-2B)	Z2	572850 R	322,77		
B 20*			570860	203,40		V 54		570175	370,51		
B 26			570870	224,16		V 54 (PR-2B)	Z2	572851 R	348,72		
B 32			570880	224,16		V 15 S (PR-2B)	Z8	574752 R	124,51		
IVT Edelstahl- Presssystem		M 15		570110	154,61	V 18 S (PR-2B)	Z8	574756 R	124,51		
		M 18 <sup>1)</sup>		570120	154,61	V 22 S (PR-2B)	Z8	574758 R	124,51		
		M 22		570130	154,61	V 28 S (PR-2B)	Z8	574760 R	124,51		
		M 28 <sup>1)</sup>		570140	154,61	V 35 S (PR-2B)	Z8	574762 R	136,96		
		M 35		570150	154,61						
		M 42 (PR-3S)	Z2	572706 R	672,57						
		M 54 (PR-3S)	Z2	572708 R	672,57						
		M 76,1 XL (PR-3S)	Z6 XL <sup>3)</sup> / Z7 XL 45 kN <sup>4)</sup>	579101 R	1.161,47						
		M 88,9 G XL (PR-3S)	Z6 XL <sup>3)</sup> / Z7 XL 45 kN <sup>4)</sup>	579110 R	1.355,58						
		M 108,0 G XL (PR-3S)	Z6 XL <sup>3)</sup> / Z7 XL 45 kN <sup>4)</sup>	579111 R	1.355,58						
		M 15 S (PR-2B)	Z8	574738 R	124,51						
	M 18 S (PR-2B)	Z8	574740 R	124,51							
	M 22 S (PR-2B)	Z8	574742 R	124,51							
	M 28 S (PR-2B)	Z8	574744 R	124,51							
	M 35 S (PR-2B)	Z8	574746 R	136,96							

Pressfitting systems for gas installations must only be pressed with pressing tongs/pressing rings which are highlighted in yellow.

Observe the national regulations. Read and observe the instructions for use and the installation instructions of the system provider/manufacturer.

\* Can also be driven by the REMS Eco-Press manual radial press, see page 185. Observe the national regulations.

\*\* Can also be driven by the REMS Eco-Press manual radial press using the Z8 adapter tongs, see page 185. Observe the national regulations.

<sup>1)</sup> Only pressing tongs from designation "108" (1<sup>st</sup> quarter of 2008), "208" (2<sup>nd</sup> quarter of 2008) etc. can be used. The designation is stamped on every pressing jaw.

<sup>2)</sup> For this pressfitting system producing a pressing joint with manual radial presses is not permitted.

<sup>3)</sup> Driven by REMS Power-Press XL ACC, see page 188.

<sup>4)</sup> Driven by REMS Akku-Press XL 45 kN 22V ACC, see page 196.

<sup>5)</sup> For taking suitable pressing inserts.

<sup>6)</sup> Press fittings made of red bronze (Sanpress XL) must be pressed with pressing rings with press contour VR, copper fittings (Profipress XL, Profipress G XL), carbon steel (Prestabo XL) and stainless steel fittings (Sanpress Inox XL, Sanpress Inox G XL) with pressing rings with press contour VF.

<sup>7)</sup> Use pressing rings labelled "M 88.9 G" or "M 108 G" on the three pressing segments for gas installations.

<sup>8)</sup> For making press joints for operating pressure ≤ PN 10.

<sup>9)</sup> For pipes of the EN technical standard. Observe the instructions for use of the system provider/manufacturer.

<sup>10)</sup> For pipes of the ASTM technical standard. Observe the instructions for use of the system provider/manufacturer.

<sup>11)</sup> Only use pressing tongs identified by "VMP ½" G" on the pressing jaws for gas installations.

<sup>12)</sup> Previous designation: C 26 pressing tongs

The suitability of REMS pressing tools for pressfitting systems: Date 27.10.2023. For the updated situation regarding suitability status check our website: [www.rems.de](http://www.rems.de) > Downloads > Product catalogues, brochures > REMS Catalogue.

See page 238 for adapter tongs. Pressing tongs/pressing rings for additional pressfitting systems on request.

# REMS pressing tongs REMS pressing rings

Accessories for REMS radial presses (except for REMS Mini-Press)  
and suitable radial presses of other makes

System	Pressing tongs / pressing rings	Driven by adapter tongs	Art.-No.	€
Jansen AG	TH 14*		570455	186,32
JANSEN COMISA	TH 16*		570460	186,32
	TH 20*		570470	186,32
	TH 26*		570475	186,32
	TH 32		570480	186,32
	TH 40		570485	246,99
	TH 50 (PZ-S)		572400	645,58
	TH 63 (PZ-S)		572405	645,58
	TH 14 S (PR-2B)**	Z8	574778 R	124,51
	TH 16 S (PR-2B)**	Z8	574782 R	124,51
	TH 20 S (PR-2B)**	Z8	574788 R	124,51
	TH 26 S (PR-2B)**	Z8	574794 R	124,51
	TH 32 S (PR-2B)**	Z8	574798 R	136,96
Jaralflex-Presssystem	TH 14*		570455	186,32
	TH 16*		570460	186,32
	TH 17*		570462	186,32
	TH 18*		570465	186,32
	TH 20*		570470	186,32
	TH 25*		570495	186,32
	TH 26*		570475	186,32
	TH 32		570480	186,32
	TH 40		570485	246,99
	TH 50 (PZ-S)		572400	645,58
	TH 63 (PZ-S)		572405	645,58
	TH 14 S (PR-2B)**	Z8	574778 R	124,51
	TH 16 S (PR-2B)**	Z8	574782 R	124,51
	TH 17 S (PR-2B)**	Z8	574784 R	124,51
	TH 18 S (PR-2B)**	Z8	574786 R	124,51
	TH 20 S (PR-2B)**	Z8	574788 R	124,51
	TH 25 S (PR-2B)**	Z8	574792 R	124,51
	TH 26 S (PR-2B)**	Z8	574794 R	124,51
	TH 32 S (PR-2B)**	Z8	574798 R	136,96
JUNGWOO	VUS 1/2" (OD 15,9 mm)		571770	186,79
JWPress	VUS 3/4" (OD 22,2 mm)		571775	186,79
	VUS 1" (OD 28,6 mm)		571780	186,79
	VUS 1 1/4" (OD 34,9 mm)		571785	186,79
	VUS 1 1/2" (OD 41,3 mm)		571790	360,13
	VUS 2" (OD 54,0 mm)		571795	370,51
	VUSFz 2 1/4" (PR-3B) (OD 66,7 mm)	Z5	572819 R	609,25
	VUSFz 3" (PR-3B) (OD 79,4 mm)	Z5	572820 R	609,25
	VUSFz 4" (PR-3B) (OD 104,8 mm)	Z5	572821 R	645,58

## K

KAN	U 14*		570760	174,33
KAN-therm Press LBP	U 16*		570765	174,33
	U 20*		570775	174,33
	U 25*		570780	174,33
	U 26* <sup>(12)</sup>		570750	204,43
	U 32		570785	204,43
	U 40		570790	249,07
	TH 14*		570455	186,32
	TH 16*		570460	186,32
	TH 20*		570470	186,32
	TH 25*		570495	186,32
	TH 26*		570475	186,32
	TH 32		570480	186,32
	TH 40		570485	246,99
	TH 50 (PZ-S)		572400	645,58
	TH 63 (PZ-S)		572405	645,58
	TH 14 S (PR-2B)**	Z8	574778 R	124,51
	TH 16 S (PR-2B)**	Z8	574782 R	124,51
	TH 20 S (PR-2B)**	Z8	574788 R	124,51
	TH 25 S (PR-2B)**	Z8	574792 R	124,51
	TH 26 S (PR-2B)**	Z8	574794 R	124,51
	TH 32 S (PR-2B)**	Z8	574798 R	136,96
KAN	M 15		570110	154,61
KAN-therm Inox	M 18 <sup>(1)</sup>		570120	154,61
	M 22		570130	154,61
	M 28 <sup>(1)</sup>		570140	154,61
	M 35		570150	154,61
	M 42 (PZ-4G)		570160	498,19
	M 54 (PZ-4G)		570170	498,19
	M 42 (PR-3S)	Z2	572706 R	672,57
	M 54 (PR-3S)	Z2	572708 R	672,57
	M 76,1 XL (PR-3S)	Z6 XL <sup>(3)</sup> / Z7 XL 45 kN <sup>(4)</sup>	579101 R	1.161,47
	M 88,9 G XL (PR-3S)	Z6 XL <sup>(3)</sup> / Z7 XL 45 kN <sup>(4)</sup>	579110 R	1.355,58
	M 108,0 G XL (PR-3S)	Z6 XL <sup>(3)</sup> / Z7 XL 45 kN <sup>(4)</sup>	579111 R	1.355,58
	M 15 S (PR-2B)	Z8	574738 R	124,51
	M 18 S (PR-2B)	Z8	574740 R	124,51
	M 22 S (PR-2B)	Z8	574742 R	124,51
	M 28 S (PR-2B)	Z8	574744 R	124,51
	M 35 S (PR-2B)	Z8	574746 R	136,96
KAN	M 12		570100	154,61
KAN-therm Steel	M 15		570110	154,61
	M 18 <sup>(1)</sup>		570120	154,61
	M 22		570130	154,61
	M 28 <sup>(1)</sup>		570140	154,61
	M 35		570150	154,61
	M 42 (PZ-4G)		570160	498,19
	M 54 (PZ-4G)		570170	498,19
	M 42 (PR-3S)	Z2	572706 R	672,57
	M 54 (PR-3S)	Z2	572708 R	672,57
	XP 66,7 XL (PR-3S)	Z6 XL <sup>(3)</sup> / Z7 XL 45 kN <sup>(4)</sup>	579108 R	1.161,47
	M 76,1 XL (PR-3S)	Z6 XL <sup>(3)</sup> / Z7 XL 45 kN <sup>(4)</sup>	579101 R	1.161,47
	M 88,9 G XL (PR-3S)	Z6 XL <sup>(3)</sup> / Z7 XL 45 kN <sup>(4)</sup>	579110 R	1.355,58
	M 108,0 G XL (PR-3S)	Z6 XL <sup>(3)</sup> / Z7 XL 45 kN <sup>(4)</sup>	579111 R	1.355,58
	M 12 S (PR-2B)	Z8	574736 R	124,51
	M 15 S (PR-2B)	Z8	574738 R	124,51
	M 18 S (PR-2B)	Z8	574740 R	124,51
	M 22 S (PR-2B)	Z8	574742 R	124,51
	M 28 S (PR-2B)	Z8	574744 R	124,51
	M 35 S (PR-2B)	Z8	574746 R	136,96

System	Pressing tongs / pressing rings	Driven by adapter tongs	Art.-No.	€
KAN	U 14*		570760	174,33
KAN-therm	U 16*		570765	174,33
UltraPRESS	U 20*		570775	174,33
	U 25*		570780	174,33
	U 26* <sup>(12)</sup>		570750	204,43
	U 32		570785	204,43
	U 40		570790	249,07
	TH 14*		570455	186,32
	TH 16*		570460	186,32
	TH 20*		570470	186,32
	TH 25*		570495	186,32
	TH 26*		570475	186,32
	TH 32		570480	186,32
	TH 40		570485	246,99
	TH 50 (PZ-S)		572400	645,58
	TH 63 (PZ-S)		572405	645,58
	TH 14 S (PR-2B)**	Z8	574778 R	124,51
	TH 16 S (PR-2B)**	Z8	574782 R	124,51
	TH 20 S (PR-2B)**	Z8	574788 R	124,51
	TH 25 S (PR-2B)**	Z8	574792 R	124,51
	TH 26 S (PR-2B)**	Z8	574794 R	124,51
	TH 32 S (PR-2B)	Z8	574798 R	136,96
KE KELIT	M 15		570110	154,61
COPPERFIX	M 18		570120	154,61
Kupfer	M 22		570130	154,61
	M 28		570140	154,61
	M 35		570150	154,61
	M 42 (PR-3S)	Z2	572706 R	672,57
	M 54 (PR-3S)	Z2	572708 R	672,57
	M 76,1 XL (PR-3S)	Z6 XL <sup>(3)</sup> / Z7 XL 45 kN <sup>(4)</sup>	579101 R	1.161,47
	M 88,9 G XL (PR-3S)	Z6 XL <sup>(3)</sup> / Z7 XL 45 kN <sup>(4)</sup>	579110 R	1.355,58
	M 108,0 G XL (PR-3S)	Z6 XL <sup>(3)</sup> / Z7 XL 45 kN <sup>(4)</sup>	579111 R	1.355,58
	M 15 S (PR-2B)	Z8	574738 R	124,51
	M 18 S (PR-2B)	Z8	574740 R	124,51
	M 22 S (PR-2B)	Z8	574742 R	124,51
	M 28 S (PR-2B)	Z8	574744 R	124,51
	M 35 S (PR-2B)	Z8	574746 R	136,96
KE KELIT	U 16*		570765	174,33
KELIT KELOX	U 18*		570770	174,33
	U 20*		570775	174,33
	U 25*		570780	174,33
	U 32		570785	204,43
	U 40		570790	249,07
	U 50		570795	298,89
	U 63 (PZ-S)		572365	645,58
	U 63 (PR-3B)	Z4	572837 R	733,81
	U 75 (PR-3B)	Z4	572828 R	645,58
KE KELIT	U 16*		570765	174,33
KELOX-PPSU-W	U 18*		570770	174,33
	U 20*		570775	174,33
	U 25*		570780	174,33
	U 32		570785	204,43
	U 40		570790	249,07
	U 50		570795	298,89
	U 63 (PZ-S)		572365	645,58
	U 63 (PR-3B)	Z4	572837 R	733,81
	U 75 (PR-3B)	Z4	572828 R	645,58
KE KELIT	U 16*		570765	174,33
KELOX-ULTRAX	U 18*		570770	174,33
	U 20*		570775	174,33
	U 25*		570780	174,33
	U 32		570785	204,43
	U 40		570790	249,07
	U 50		570795	298,89
	U 63 (PZ-S)		572365	645,58
	U 63 (PR-3B)	Z4	572837 R	733,81
	U 75 (PR-3B)	Z4	572828 R	645,58
KE KELIT	U 16*		570765	174,33
KELOX-ULTRAX-W	U 18*		570770	174,33
	U 20*		570775	174,33
	U 25*		570780	174,33
	U 32		570785	204,43
	U 40		570790	249,07
	U 50		570795	298,89
	U 63 (PZ-S)		572365	645,58
	U 63 (PR-3B)	Z4	572837 R	733,81
	U 75 (PR-3B)	Z4	572828 R	645,58
KE KELIT	U 16*		570765	174,33
KELOX-WINDOX-U	U 18*		570770	174,33
	U 20*		570775	174,33
	U 25*		570780	174,33
	U 32		570785	204,43
	U 40		570790	249,07
	U 50		570795	298,89
	U 63 (PZ-S)		572365	645,58
	U 63 (PR-3B)	Z4	572837 R	733,81
	U 75 (PR-3B)	Z4	572828 R	645,58
KE KELIT	M 15		570110	154,61
steelFIX	M 18		570120	154,61
C-Stahl	M 22		570130	154,61
	M 28		570140	154,61
	M 35		570150	154,61
	M 42 (PR-3S)	Z2	572706 R	672,57
	M 54 (PR-3S)	Z2	572708 R	672,57
	M 76,1 XL (PR-3S)	Z6 XL <sup>(3)</sup> / Z7 XL 45 kN <sup>(4)</sup>	579101 R	1.161,47
	M 88,9 G XL (PR-3S)	Z6 XL <sup>(3)</sup> / Z7 XL 45 kN <sup>(4)</sup>	579110 R	1.355,58
	M 108,0 G XL (PR-3S)	Z6 XL <sup>(3)</sup> / Z7 XL 45 kN <sup>(4)</sup>	579111 R	1.355,58
	M 15 S (PR-2B)	Z8	574738 R	124,51
	M 18 S (PR-2B)	Z8	574740 R	124,51
	M 22 S (PR-2B)	Z8	574742 R	124,51
	M 28 S (PR-2B)	Z8	574744 R	124,51
	M 35 S (PR-2B)	Z8	574746 R	136,96

**REMS pressing tongs**  
**REMS pressing rings**

Accessories for REMS radial presses (except for REMS Mini-Press)  
and suitable radial presses of other makes

System	Pressing tongs/ pressing rings	Driven by adapter tongs	Art.-No.	€
KE KELIT steelFIX Edelstahl	M 15		570110	154,61
	M 18		570120	154,61
	M 22		570130	154,61
	M 28		570140	154,61
	M 35		570150	154,61
	M 42 (PR-3S)	Z2	572706 R	672,57
	M 54 (PR-3S)	Z2	572708 R	672,57
	M 76,1 XL (PR-3S)	Z6 XL <sup>3)</sup> / Z7 XL 45kN <sup>4)</sup>	579101 R	1.161,47
	M 88,9 G XL (PR-3S)	Z6 XL <sup>3)</sup> / Z7 XL 45kN <sup>4)</sup>	579110 R	1.355,58
	M 108,0 G XL (PR-3S)	Z6 XL <sup>3)</sup> / Z7 XL 45kN <sup>4)</sup>	579111 R	1.355,58
	M 15 S (PR-2B)	Z8	574738 R	124,51
	M 18 S (PR-2B)	Z8	574740 R	124,51
	M 22 S (PR-2B)	Z8	574742 R	124,51
	M 28 S (PR-2B)	Z8	574744 R	124,51
	M 35 S (PR-2B)	Z8	574746 R	136,96
	KEMBLA KemPress (AUS)	VAU 15 (OD 12,7 mm)		572687
VAU 20 (OD 19,1 mm)			572689	159,80
VAU 25 (OD 25,4 mm)			572691	159,80
VAU 32 (OD 31,8 mm)			572693	168,10
VAU 40 (OD 38,1 mm)			572695	249,07
VAU 50 (OD 50,8 mm)			572697	441,10
KEMBLA KemPress Gas (AUS)	VAU 15 (OD 12,7 mm)		572687	159,80
	VAU 20 (OD 19,1 mm)		572689	159,80
	VAU 25 (OD 25,4 mm)		572691	159,80
	VAU 32 (OD 31,8 mm)		572693	168,10
	VAU 40 (OD 38,1 mm)		572695	249,07
	VAU 50 (OD 50,8 mm)		572697	441,10
KISAN Kisan KD	KI 16*		571360	197,17
	KI 20*		571370	197,17
	KI 25*		571375	197,17
	TH 16*		570460	186,32
	TH 20*		570470	186,32
	TH 25*		570495	186,32
	TH 16 S (PR-2B)**	Z8	574782 R	124,51
	TH 20 S (PR-2B)**	Z8	574788 R	124,51
	TH 25 S (PR-2B)**	Z8	574792 R	124,51
	KISAN Kisan WL	KI 16*		571360
KI 20*			571370	197,17
KI 25*			571375	197,17
KI 32			571380	265,68
TH 16*			570460	186,32
TH 20*			570470	186,32
TH 25*			570495	186,32
TH 32			570480	186,32
TH 16 S (PR-2B)**		Z8	574782 R	124,51
TH 20 S (PR-2B)**		Z8	574788 R	124,51
KISAN Kisan WM	KI 16*		571360	197,17
	KI 20*		571370	197,17
	KI 25*		571375	197,17
	KI 32		571380	265,68
	KISAN Kisan WR	U 20*		570775
U 25*			570780	174,33
U 32			570785	204,43
U 40			570790	249,07
U 50			570795	298,89
U 63 (PZ-S)			572365	645,58
U 75 (PR-3B)			572828 R	645,58
TH 20*			570470	186,32
TH 25*			570495	186,32
TH 32			570480	186,32
TH 40			570485	246,99
TH 50 (PZ-S)			572400	645,58
TH 63 (PZ-S)			572405	645,58
TH 20 S (PR-2B)**		Z8	574788 R	124,51
TH 25 S (PR-2B)**		Z8	574792 R	124,51
TH 32 S (PR-2B)		Z8	574798 R	136,96

System	Pressing tongs/ pressing rings	Driven by adapter tongs	Art.-No.	€	
KISAN Kistal C	M 15		570110	154,61	
	M 18		570120	154,61	
	M 22		570130	154,61	
	M 28		570140	154,61	
	M 35		570150	154,61	
	M 42 (PR-3S)	Z2	572706 R	672,57	
	M 54 (PR-3S)	Z2	572708 R	672,57	
	M 76,1 XL (PR-3S)	Z6 XL <sup>3)</sup> / Z7 XL 45kN <sup>4)</sup>	579101 R	1.161,47	
	M 88,9 G XL (PR-3S)	Z6 XL <sup>3)</sup> / Z7 XL 45kN <sup>4)</sup>	579110 R	1.355,58	
	M 108,0 G XL (PR-3S)	Z6 XL <sup>3)</sup> / Z7 XL 45kN <sup>4)</sup>	579111 R	1.355,58	
	M 15 S (PR-2B)	Z8	574738 R	124,51	
	M 18 S (PR-2B)	Z8	574740 R	124,51	
	M 22 S (PR-2B)	Z8	574742 R	124,51	
	M 28 S (PR-2B)	Z8	574744 R	124,51	
	M 35 S (PR-2B)	Z8	574746 R	136,96	
	KISAN Kistal Inox	M 15		570110	154,61
		M 18		570120	154,61
		M 22		570130	154,61
		M 28		570140	154,61
M 35			570150	154,61	
M 42 (PR-3S)		Z2	572706 R	672,57	
M 54 (PR-3S)		Z2	572708 R	672,57	
M 76,1 XL (PR-3S)		Z6 XL <sup>3)</sup> / Z7 XL 45kN <sup>4)</sup>	579101 R	1.161,47	
M 88,9 G XL (PR-3S)		Z6 XL <sup>3)</sup> / Z7 XL 45kN <sup>4)</sup>	579110 R	1.355,58	
M 108,0 G XL (PR-3S)		Z6 XL <sup>3)</sup> / Z7 XL 45kN <sup>4)</sup>	579111 R	1.355,58	
M 15 S (PR-2B)		Z8	574738 R	124,51	
M 18 S (PR-2B)		Z8	574740 R	124,51	
M 22 S (PR-2B)		Z8	574742 R	124,51	
M 28 S (PR-2B)	Z8	574744 R	124,51		
M 35 S (PR-2B)	Z8	574746 R	136,96		

**L**

System	Pressing tongs/ pressing rings	Driven by adapter tongs	Art.-No.	€
LEGEND-PRESS press fitting system	VUS ½" (OD 15,9 mm)		571770	186,79
	VUS ¾" (OD 22,2 mm)		571775	186,79
	VUS 1" (OD 28,6 mm)		571780	186,79
	VUS 1¼" (OD 34,9 mm)		571785	186,79
	VUS 1½" (OD 41,3 mm)		571790	360,13
	VUS 2" (OD 54,0 mm)		571795	370,51
	VUSFz 2½" (PR-3B) (OD 66,7 mm)	Z5	572819 R	609,25
	VUSFz 3" (PR-3B) (OD 79,4 mm)	Z5	572820 R	609,25
LK Systems LK >B-Press	VUSFz 4" (PR-3B) (OD 104,8 mm)	Z5	572821 R	645,58
	V 12		570107	154,61
LK Systems LK >B-Press Elförsinkat	V 15		570115	154,61
	V 18		570125	154,61
	V 22		570135	154,61
	V 28		570145	154,61
	V 35		570155	154,61
	V 42		570165	360,13
	V 54		570175	370,51
	V 12 S (PR-2B)	Z8	574748 R	124,51
	V 15 S (PR-2B)	Z8	574752 R	124,51
	V 18 S (PR-2B)	Z8	574756 R	124,51
	V 22 S (PR-2B)	Z8	574758 R	124,51
	V 28 S (PR-2B)	Z8	574760 R	124,51
	V 35 S (PR-2B)	Z8	574762 R	136,96
	V 12		570107	154,61
	V 15		570115	154,61
	V 18		570125	154,61
	V 22		570135	154,61
V 28		570145	154,61	
V 35		570155	154,61	
V 42		570165	360,13	
V 54		570175	370,51	
V 12 S (PR-2B)	Z8	574748 R	124,51	
V 15 S (PR-2B)	Z8	574752 R	124,51	
V 18 S (PR-2B)	Z8	574756 R	124,51	
V 22 S (PR-2B)	Z8	574758 R	124,51	
V 28 S (PR-2B)	Z8	574760 R	124,51	
V 35 S (PR-2B)	Z8	574762 R	136,96	

Pressfitting systems for gas installations must only be pressed with pressing tongs/pressing rings which are highlighted in yellow.

Observe the national regulations. Read and observe the instructions for use and the installation instructions of the system provider/manufacturer.

- \* Can also be driven by the REMS Eco-Press manual radial press, see page 185. Observe the national regulations.
- \*\* Can also be driven by the REMS Eco-Press manual radial press using the Z8 adapter tongs, see page 185. Observe the national regulations.
- <sup>1)</sup> Only pressing tongs from designation "108" (1<sup>st</sup> quarter of 2008), "208" (2<sup>nd</sup> quarter of 2008) etc. can be used. The designation is stamped on every pressing jaw.
- <sup>2)</sup> For this pressfitting system producing a pressing joint with manual radial presses is not permitted.
- <sup>3)</sup> Driven by REMS Power-Press XL ACC, see page 188.
- <sup>4)</sup> Driven by REMS Akku-Press XL 45 kN 22V ACC, see page 196.
- <sup>5)</sup> For taking suitable pressing inserts.
- <sup>6)</sup> Press fittings made of red bronze (Sanpress XL) must be pressed with pressing rings with press contour VR, copper fittings (Profipress XL, Profipress G XL), carbon steel (Prestabo XL) and stainless steel fittings (Sanpress Inox XL, Sanpress Inox G XL) with pressing rings with press contour VF.
- <sup>7)</sup> Use pressing rings labelled "M 88.9 G" or "M 108 G" on the three pressing segments for gas installations.
- <sup>8)</sup> For making press joints for operating pressure ≤ PN 10.
- <sup>9)</sup> For pipes of the EN technical standard. Observe the instructions for use of the system provider/manufacturer.
- <sup>10)</sup> For pipes of the ASTM technical standard. Observe the instructions for use of the system provider/manufacturer.
- <sup>11)</sup> Only use pressing tongs identified by "VMP ½" G" on the pressing jaws for gas installations.
- <sup>12)</sup> Previous designation: C 26 pressing tongs

The suitability of REMS pressing tools for pressfitting systems: Date 27.10.2023. For the updated situation regarding suitability status check our website:

www.rems.de > Downloads > Product catalogues, brochures > REMS Catalogue.  
See page 238 for adapter tongs. Pressing tongs/pressing rings for additional pressfitting systems on request.

# REMS pressing tongs REMS pressing rings

Accessories for REMS radial presses (except for REMS Mini-Press)  
and suitable radial presses of other makes

System	Pressing tongs / pressing rings	Driven by adapter tongs	Art.-No.	€
LK Systems LK >B-Press Gas	V 15		570115	154,61
	V 18		570125	154,61
	V 22		570135	154,61
	V 28		570145	154,61
	V 35		570155	154,61
	V 42		570165	360,13
	V 54		570175	370,51
	V 15 S (PR-2B)	Z8	574752 R	124,51
	V 18 S (PR-2B)	Z8	574756 R	124,51
	V 22 S (PR-2B)	Z8	574758 R	124,51
	V 28 S (PR-2B)	Z8	574760 R	124,51
V 35 S (PR-2B)	Z8	574762 R	136,96	
LK Systems	TH 16*		570460	186,32
LK Universal	TH 20*		570470	186,32
	TH 25*		570495	186,32
	TH 32		570480	186,32
	TH 40		570485	246,99
	TH 50 (PZ-S)		572400	645,58
	TH 63 (PZ-S)		572405	645,58

## M

MAINCOR	U 16*		570765	174,33
MAINPRESS	U 20*		570775	174,33
	U 25*		570780	174,33
	U 32		570785	204,43
	U 40		570790	249,07
	U 50		570795	298,89
	U 63 (PZ-S)		572365	645,58
	U 63 (PR-3B)	Z4	572837 R	733,81
	MAINCOR	U 16*		570765
MAINFLOR	U 20*		570775	174,33
Mair Heiztechnik M-Press	H 11,5*		570315	168,10
	TH 16*		570460	186,32
	TH 20*		570470	186,32
	TH 26*		570475	186,32
	TH 32		570480	186,32
	TH 40		570485	246,99
	TH 16 S (PR-2B)**	Z8	574782 R	124,51
	TH 20 S (PR-2B)**	Z8	574788 R	124,51
	TH 26 S (PR-2B)**	Z8	574794 R	124,51
	TH 32 S (PR-2B)	Z8	574798 R	136,96
Ma.s.ter System PRESSMASTER	TH 14*		570455	186,32
	TH 16*		570460	186,32
	TH 18*		570465	186,32
	TH 20*		570470	186,32
	TH 25*		570495	186,32
	TH 26*		570475	186,32
	TH 32		570480	186,32
	TH 40		570485	246,99
	TH 50 (PZ-S)		572400	645,58
	TH 63 (PZ-S)		572405	645,58
	TH 14 S (PR-2B)**	Z8	574778 R	124,51
	TH 16 S (PR-2B)**	Z8	574782 R	124,51
	TH 18 S (PR-2B)**	Z8	574786 R	124,51
	TH 20 S (PR-2B)**	Z8	574788 R	124,51
	TH 25 S (PR-2B)**	Z8	574792 R	124,51
	TH 26 S (PR-2B)**	Z8	574794 R	124,51
	TH 32 S (PR-2B)	Z8	574798 R	136,96
	H 14*		570310	168,10
	H 16*		570320	168,10
	H 18*		570340	168,10
	H 20*		570350	168,10
	H 26*		570370	168,10
	H 32		570380	168,10
	H 40 (PZ-4G)		570390	565,67
	U 14*		570760	174,33
	U 16*		570765	174,33
	U 18*		570770	174,33
	U 20*		570775	174,33
U 25*		570780	174,33	
U 32		570785	204,43	
U 40		570790	249,07	
U 50		570795	298,89	
U 63 (PR-3B)	Z4	572837 R	733,81	
U 63 (PZ-S)		572365	645,58	
Meier Tobler Metalplast - Stramax Serie MM	H 16*		570320	168,10
	H 20*		570350	168,10
	H 25*		570360	168,10
	H 32		570380	168,10
	Rfz 16*		571325	194,05
	Rfz 20*		571330	194,05
	Rfz 25		571335	194,05
	Rfz 32		571340	194,05
	TH 16*		570460	186,32
	TH 20*		570470	186,32
	TH 25*		570495	186,32
	TH 32		570480	186,32
	TH 40		570485	246,99
	TH 50 (PZ-S)		572400	645,58
	TH 63 (PZ-S)		572405	645,58
	TH 16 S (PR-2B)**	Z8	574782 R	124,51
	TH 20 S (PR-2B)**	Z8	574788 R	124,51
	TH 25 S (PR-2B)**	Z8	574792 R	124,51
	TH 32 S (PR-2B)	Z8	574798 R	136,96
	U 16*		570765	174,33
	U 20*		570775	174,33
	U 25*		570780	174,33
	U 32		570785	204,43
	U 40		570790	249,07
	U 50		570795	298,89
	U 63 (PZ-S)		572365	645,58
	U 63 (PR-3B)	Z4	572837 R	733,81
	U 63 (PR-3B)	Z4	572828 R	645,58

System	Pressing tongs / pressing rings	Driven by adapter tongs	Art.-No.	€	
METALGRUP	U 16*		570765	174,33	
Permatubo	U 18*		570770	174,33	
	U 20*		570775	174,33	
	U 25*		570780	174,33	
	U 32		570785	204,43	
	U 40		570790	249,07	
	U 50		570795	298,89	
	U 63 (PR-3B)	Z4	572837 R	733,81	
	U 63 (PZ-S)		572365	645,58	
	METALGRUP	Rfz 16*		571325	194,05
PexGrup	Rfz 20*		571330	194,05	
	Rfz 25		571335	194,05	
	Rfz 32		571340	194,05	
METALGRUP	U 16*		570765	174,33	
MultiGrup	U 18*		570770	174,33	
	U 20*		570775	174,33	
	U 25*		570780	174,33	
	U 32		570785	204,43	
Mueller Streamline	VUS ½" (OD 15,9 mm)		571770	186,79	
PRS Copper Press	VUS ¾" (OD 22,2 mm)		571775	186,79	
	VUS 1" (OD 28,6 mm)		571780	186,79	
	VUS 1¼" (OD 34,9 mm)		571785	186,79	
	VUS 1½" (OD 41,3 mm)		571790	360,13	
	VUS 2" (OD 54,0 mm)		571795	370,51	
	VUSFz 2½" (PR-3B) (OD 66,7 mm)	Z5	572819 R	609,25	
	VUSFz 3" (PR-3B) (OD 79,4 mm)	Z5	572820 R	609,25	
	VUSFz 4" (PR-3B) (OD 104,8 mm)	Z5	572821 R	645,58	
MULTITHERM PRESSSYSTEM	TH 16*		570460	186,32	
	TH 20*		570470	186,32	
	TH 26*		570475	186,32	
	TH 32		570480	186,32	
	TH 40		570485	246,99	
	TH 50 (PZ-S)		572400	645,58	
	TH 63 (PZ-S)		572405	645,58	
	THz 75 (PR-3B)	Z4	572829 R	609,25	
	TH 16 S (PR-2B)**	Z8	574782 R	124,51	
	TH 20 S (PR-2B)**	Z8	574788 R	124,51	
	TH 26 S (PR-2B)**	Z8	574794 R	124,51	
	TH 32 S (PR-2B)	Z8	574798 R	136,96	
Multicap Industrial AIS PEX	Rfz 16*		571325	194,05	
	Rfz 20*		571330	194,05	
	Rfz 25		571335	194,05	
	Rfz 32		571340	194,05	
	U 16*		570765	174,33	
	U 20*		570775	174,33	
	U 25*		570780	174,33	
	U 32		570785	204,43	
	Multicap Industrial AIS XPRT	H 16*		570320	168,10
		H 20*		570350	168,10
		H 25*		570360	168,10
		H 32		570380	168,10
		Rfz 16*		571325	194,05
		Rfz 20*		571330	194,05
Rfz 25			571335	194,05	
Rfz 32			571340	194,05	
TH 16*			570460	186,32	
TH 20*			570470	186,32	
TH 25*			570495	186,32	
TH 26*			570475	186,32	
TH 32			570480	186,32	
TH 40			570485	246,99	
TH 50 (PZ-S)		572400	645,58		
TH 63 (PZ-S)		572405	645,58		
THz 75 (PR-3B)	Z4	572829 R	609,25		
TH 16 S (PR-2B)**	Z8	574782 R	124,51		
TH 20 S (PR-2B)**	Z8	574788 R	124,51		
TH 25 S (PR-2B)**	Z8	574792 R	124,51		
TH 26 S (PR-2B)**	Z8	574794 R	124,51		
TH 32 S (PR-2B)	Z8	574798 R	136,96		
Multicap Industrial multitubo systems MC	U 16*		570765	174,33	
	U 18*		570770	174,33	
	U 20*		570775	174,33	
	U 25*		570780	174,33	
	U 32		570785	204,43	
	U 40		570790	249,07	
	U 50		570795	298,89	
	U 63 (PZ-S)		572365	645,58	
	U 63 (PR-3B)	Z4	572837 R	733,81	
	U 75 (PR-3B)	Z4	572828 R	645,58	
	U 16*		570765	174,33	
	U 18*		570770	174,33	
	U 20*		570775	174,33	
	U 25*		570780	174,33	
U 32		570785	204,43		
U 40		570790	249,07		
U 50		570795	298,89		
U 63 (PZ-S)		572365	645,58		
U 63 (PR-3B)	Z4	572837 R	733,81		
U 75 (PR-3B)	Z4	572828 R	645,58		

# REMS pressing tongs REMS pressing rings

Accessories for REMS radial presses (except for REMS Mini-Press)  
and suitable radial presses of other makes

System	Pressing tongs/ pressing rings	Driven by adapter tongs	Art.-No.	€	System	Pressing tongs/ pressing rings	Driven by adapter tongs	Art.-No.	€
Multicap Industrial multitubo systems MM	H 16*		570320	168,10	NUPI Industrie Italiane Multinupi	B 16*		570850	203,40
	H 20*		570350	168,10		B 18*		570855	203,40
	H 25*		570360	168,10		B 20*		570860	203,40
	H 26*		570370	168,10		B 26		570870	224,16
	H 32		570380	168,10		B 32		570880	224,16
	RFz 16*		571325	194,05		F 16*		570717	177,45
	RFz 20*		571330	194,05		F 18*		570720	177,45
	RFz 25		571335	194,05		F 20*		570727	177,45
	RFz 32		571340	194,05		F 26*		570730	191,98
	TH 16*		570460	186,32		F 32		570735	191,98
	TH 20*		570470	186,32		F 16 S (PR-2B)**	Z8	574728 R	124,51
	TH 25*		570495	186,32		F 20 S (PR-2B)**	Z8	574730 R	124,51
	TH 26*		570475	186,32		F 26 S (PR-2B)**	Z8	574732 R	124,51
	TH 32		570480	186,32		F 32 S (PR-2B)	Z8	574734 R	136,96
	TH 40		570485	246,99		H 16*		570320	168,10
	TH 50 (PZ-S)		572400	645,58		H 18*		570340	168,10
	TH 63 (PZ-S)		572405	645,58		H 20*		570350	168,10
	THz 75 (PR-3B)	Z4	572829 R	609,25		H 25*		570360	168,10
	TH 16 S (PR-2B)**	Z8	574782 R	124,51		H 26*		570370	168,10
	TH 20 S (PR-2B)**	Z8	574788 R	124,51		H 32		570380	168,10
	TH 25 S (PR-2B)**	Z8	574792 R	124,51		TH 16*		570460	186,32
	TH 26 S (PR-2B)**	Z8	574794 R	124,51		TH 18*		570465	186,32
	TH 32 S (PR-2B)	Z8	574798 R	136,96		TH 20*		570470	186,32
	U 16*		570765	174,33		TH 25*		570495	186,32
	U 20*		570775	174,33		TH 26*		570475	186,32
	U 25*		570780	174,33		TH 32		570480	186,32
	U 32		570785	204,43		TH 40		570485	246,99
	U 40		570790	249,07		TH 50 (PZ-S)		572400	645,58
	U 50		570795	298,89		TH 63 (PZ-S)		572405	645,58
	U 63 (PZ-S)		572365	645,58		TH 16 S (PR-2B)**	Z8	574782 R	124,51
	U 63 (PR-3B)	Z4	572837 R	733,81		TH 20 S (PR-2B)**	Z8	574788 R	124,51
	U 75 (PR-3B)	Z4	572828 R	645,58		TH 26 S (PR-2B)**	Z8	574794 R	124,51
						TH 32 S (PR-2B)	Z8	574798 R	136,96
						U 14*		570760	174,33
						U 16*		570765	174,33
						U 18*		570770	174,33
						U 20*		570775	174,33
						U 25*		570780	174,33
						U 26* <sup>12)</sup>		570750	204,43
				U 32		570785	204,43		
				U 40		570790	249,07		
				U 50		570795	298,89		
				U 63 (PR-3B)	Z4	572837 R	733,81		
				U 63 (PZ-S)		572365	645,58		
				Nussbaum Optifitt-Press	VMP 3/8" (OD 12,2 mm)	571740	214,81		
					VMP 1/2" G (OD 21,3 mm)	571766 R	214,81		
					VMPz 3/4" (OD 26,9 mm)	571764	214,81		
					VMPz 1" (OD 33,7 mm)	571767	214,81		
					VMPz 1 1/4" (PZ-S) (OD 42,4 mm)	572413	704,75		
					VMPz 1 1/2" (PR-3B) (OD 48,3 mm)	572844 R	479,50		
					VMPz 2" (PR-3B) (OD 60,3 mm)	572845 R	479,50		
				Nussbaum Optiflex-Flowpress	VRX 16	571750	196,13		
					VRX 20	571752	196,13		
					VRX 25	571754	214,81		
					VRX 32	571756	214,81		
					VRX 40	571758	298,89		
					VRX 50	571760	348,72		
					VRX 63	571797	560,47		
				Nussbaum Optipress	V 15	570115	154,61		
					V 18	570125	154,61		
				Aquaplus	V 22	570135	154,61		
					V 28	570145	154,61		
					V 35	570155	154,61		
					V 42	570165	360,13		
					V 42 (PR-2B)	572850 R	322,77		
					V 54	570175	370,51		
					V 54 (PR-2B)	572851 R	348,72		
					Vfz 64,0 (PR-3B)	25	572815 R	609,25	
					Vfz 76,1 (PR-3B)	25	572816 R	609,25	
					Vfz 88,9 (PR-3B)	25	572817 R	645,58	
					Vfz 108,0 (PR-3B)	25	572818 R	645,58	
					V 15 S (PR-2B)	Z8	574752 R	124,51	
					V 18 S (PR-2B)	Z8	574756 R	124,51	
					V 22 S (PR-2B)	Z8	574758 R	124,51	
					V 28 S (PR-2B)	Z8	574760 R	124,51	
					V 35 S (PR-2B)	Z8	574762 R	136,96	
<b>N</b>									
NEUTHERM MEKUPRESS-HT	H 16*		570320	168,10					
	H 20*		570350	168,10					
	H 26*		570370	168,10					
	H 32		570380	168,10					
	H 40 (PZ-4G)		570390	565,67					
	U 40		570790	249,07					
NIBCO Press System Copper	VUS 1/2" (OD 15,9 mm)		571770	186,79					
	VUS 3/4" (OD 22,2 mm)		571775	186,79					
	VUS 1" (OD 28,6 mm)		571780	186,79					
	VUS 1 1/4" (OD 34,9 mm)		571785	186,79					
	VUS 1 1/2" (OD 41,3 mm)		571790	360,13					
	VUS 2" (OD 54,0 mm)		571795	370,51					
NICOLL FLUXO	TH 16*		570460	186,32					
	TH 20*		570470	186,32					
	TH 26*		570475	186,32					
	TH 32		570480	186,32					
	TH 40		570485	246,99					
	TH 50 (PZ-S)		572400	645,58					
	TH 63 (PZ-S)		572405	645,58					
	THz 75 (PR-3B)	Z4	572829 R	609,25					
	TH 16 S (PR-2B)**	Z8	574782 R	124,51					
	TH 20 S (PR-2B)**	Z8	574788 R	124,51					
	TH 26 S (PR-2B)**	Z8	574794 R	124,51					
	TH 32 S (PR-2B)	Z8	574798 R	136,96					

Pressfitting systems for gas installations must only be pressed with pressing tongs/pressing rings which are highlighted in yellow.

Observe the national regulations. Read and observe the instructions for use and the installation instructions of the system provider/manufacturer.

\* Can also be driven by the REMS Eco-Press manual radial press, see page 185. Observe the national regulations.

\*\* Can also be driven by the REMS Eco-Press manual radial press using the Z8 adapter tongs, see page 185. Observe the national regulations.

<sup>1)</sup> Only pressing tongs from designation "108" (1<sup>st</sup> quarter of 2008), "208" (2<sup>nd</sup> quarter of 2008) etc. can be used. The designation is stamped on every pressing jaw.

<sup>2)</sup> For this pressfitting system producing a pressing joint with manual radial presses is not permitted.

<sup>3)</sup> Driven by REMS Power-Press XL ACC, see page 188.

<sup>4)</sup> Driven by REMS Akku-Press XL 45 kN 22V ACC, see page 196.

<sup>5)</sup> For taking suitable pressing inserts.

<sup>6)</sup> Press fittings made of red bronze (Sanpress XL) must be pressed with pressing rings with press contour VR, copper fittings (Profipress XL, Profipress G XL), carbon steel (Prestabo XL) and stainless steel fittings (Sanpress Inox XL, Sanpress Inox G XL) with pressing rings with press contour VF.

<sup>7)</sup> Use pressing rings labelled "M 88.9 G" or "M 108 G" on the three pressing segments for gas installations.

<sup>8)</sup> For making press joints for operating pressure ≤ PN 10.

<sup>9)</sup> For pipes of the EN technical standard. Observe the instructions for use of the system provider/manufacturer.

<sup>10)</sup> For pipes of the ASTM technical standard. Observe the instructions for use of the system provider/manufacturer.

<sup>11)</sup> Only use pressing tongs identified by "VMP 1/2" G" on the pressing jaws for gas installations.

<sup>12)</sup> Previous designation: C 26 pressing tongs

The suitability of REMS pressing tools for pressfitting systems: Date 27.10.2023. For the updated situation regarding suitability status check our website:

www.rems.de > Downloads > Product catalogues, brochures > REMS Catalogue.

See page 238 for adapter tongs. Pressing tongs/pressing rings for additional pressfitting systems on request.

System	Pressing tongs / pressing rings	Driven by adapter tongs	Art.-No.	€
Nussbaum Optipress-Gaz	V 15		570115	154,61
	V 18		570125	154,61
	V 22		570135	154,61
	V 28		570145	154,61
	V 35		570155	154,61
	V 42		570165	360,13
	V 42 (PR-2B)	Z2	572850 R	322,77
	V 54		570175	370,51
	V 54 (PR-2B)	Z2	572851 R	348,72
	VfZ 64,0 (PR-3B)	Z5	572815 R	609,25
	VfZ 76,1 (PR-3B)	Z5	572816 R	609,25
	VfZ 88,9 (PR-3B)	Z5	572817 R	645,58
	VfZ 108,0 (PR-3B)	Z5	572818 R	645,58
	V 15 S (PR-2B)	Z8	574752 R	124,51
	V 18 S (PR-2B)	Z8	574756 R	124,51
	V 22 S (PR-2B)	Z8	574758 R	124,51
V 28 S (PR-2B)	Z8	574760 R	124,51	
V 35 S (PR-2B)	Z8	574762 R	136,96	
Nussbaum Optipress-Therm	V 15		570115	154,61
	V 18		570125	154,61
	V 22		570135	154,61
	V 28		570145	154,61
	V 35		570155	154,61
	V 42		570165	360,13
	V 42 (PR-2B)	Z2	572850 R	322,77
	V 54		570175	370,51
	V 54 (PR-2B)	Z2	572851 R	348,72
	VfZ 64,0 (PR-3B)	Z5	572815 R	609,25
	VfZ 76,1 (PR-3B)	Z5	572816 R	609,25
	VfZ 88,9 (PR-3B)	Z5	572817 R	645,58
	VfZ 108,0 (PR-3B)	Z5	572818 R	645,58
	V 15 S (PR-2B)	Z8	574752 R	124,51
	V 18 S (PR-2B)	Z8	574756 R	124,51
	V 22 S (PR-2B)	Z8	574758 R	124,51
V 28 S (PR-2B)	Z8	574760 R	124,51	
V 35 S (PR-2B)	Z8	574762 R	136,96	
<b>O</b>				
Oventrop Cofit P	H 16 A*		570620	214,81
	H 20 A*		570650	214,81
	H 26 A*		570670	214,81
	H 32 A		570680	214,81
	H 40 A		570690	373,63
	U 50		570795	298,89
	U 63 (PR-3B)	Z4	572837 R	733,81
	U 63 (PZ-S)		572365	645,58
Oventrop Cofit PD	H 16 A*		570620	214,81
	H 20 A*		570650	214,81
	H 26 A*		570670	214,81
Oventrop Cofit PDK	H 16 A*		570620	214,81
	H 20 A*		570650	214,81
Oventrop Cofit PD-HT	H 16 A*		570620	214,81
	H 20 A*		570650	214,81
	H 25 A*		570660	214,81
Oventrop Cofit PDK-HT	H 16 A*		570620	214,81
	H 20 A*		570650	214,81
<b>P</b>				
PBTub SERTIPRESS	RfZ 12*		571320	194,05
	RfZ 16*		571325	194,05
	RfZ 20*		571330	194,05
	RfZ 25		571335	194,05
PBTub SERTI-STEEL	M 15		570110	154,61
	M 18		570120	154,61
	M 22		570130	154,61
	M 28		570140	154,61
	M 35		570150	154,61
	M 42 (PR-3S)	Z2	572706 R	672,57
	M 54 (PR-3S)	Z2	572708 R	672,57
	M 15 S (PR-2B)	Z8	574738 R	124,51
	M 18 S (PR-2B)	Z8	574740 R	124,51
	M 22 S (PR-2B)	Z8	574742 R	124,51
M 28 S (PR-2B)	Z8	574744 R	124,51	
M 35 S (PR-2B)	Z8	574746 R	136,96	
Pegler Yorkshire	> Aalberts integrated piping systems			
PERFEXIM PERFEKT SYSTEM	U 16*		570765	174,33
	U 20*		570775	174,33
	U 25*		570780	174,33
	U 32		570785	204,43
	U 32		570785	204,43
PERFEXIM PERFEKT SYSTEM PLUS	U 16*		570765	174,33
	U 20*		570775	174,33
	U 25*		570780	174,33
	U 32		570785	204,43
	U 40		570790	249,07
	U 50		570795	298,89
	U 63 (PZ-S)		572365	645,58
	TH 16*		570460	186,32
	TH 20*		570470	186,32
	TH 25*		570495	186,32
	TH 32		570480	186,32
	TH 40		570485	246,99
	TH 50 (PZ-S)		572400	645,58
TH 63 (PZ-S)		572405	645,58	
TH 16 S (PR-2B)**	Z8	574782 R	124,51	
TH 20 S (PR-2B)**	Z8	574788 R	124,51	
TH 25 S (PR-2B)**	Z8	574792 R	124,51	
TH 32 S (PR-2B)	Z8	574798 R	136,96	

System	Pressing tongs / pressing rings	Driven by adapter tongs	Art.-No.	€	
PERFILTUBO PERFILALUPEX	U 16*		570765	174,33	
	U 18*		570770	174,33	
	U 20*		570775	174,33	
	U 25*		570780	174,33	
	U 32		570785	204,43	
	U 40		570790	249,07	
	U 50		570795	298,89	
	U 63 (PR-3B)	Z4	572837 R	733,81	
	U 63 (PZ-S)		572365	645,58	
	U 75 (PR-3B)	Z4	572828 R	645,58	
PERFILTUBO PERFILPRESS	M 15		570110	154,61	
	M 18		570120	154,61	
	M 22		570130	154,61	
	M 28		570140	154,61	
	M 35		570150	154,61	
	M 42 (PR-3S)	Z2	572706 R	672,57	
	M 54 (PR-3S)	Z2	572708 R	672,57	
	M 76,1 XL (PR-3S)	Z6 XL <sup>3)</sup> / Z7 XL 45 kN <sup>4)</sup>	579101 R	1.161,47	
	M 15 S (PR-2B)	Z8	574738 R	124,51	
	M 18 S (PR-2B)	Z8	574740 R	124,51	
	M 22 S (PR-2B)	Z8	574742 R	124,51	
	M 28 S (PR-2B)	Z8	574744 R	124,51	
M 35 S (PR-2B)	Z8	574746 R	136,96		
PEXTUBE PexTube	RfZ 16*		571325	194,05	
	RfZ 20*		571330	194,05	
	RfZ 25		571337	213,78	
	RfZ 32		571342	213,78	
Pipelife C-PRESS	M 15		570110	154,61	
	M 18		570120	154,61	
	M 22		570130	154,61	
	M 28		570140	154,61	
	M 35		570150	154,61	
	M 42 (PR-3S)	Z2	572706 R	672,57	
	M 54 (PR-3S)	Z2	572708 R	672,57	
	M 76,1 XL (PR-3S)	Z6 XL <sup>3)</sup> / Z7 XL 45 kN <sup>4)</sup>	579101 R	1.161,47	
	M 88,9 G XL (PR-3S)	Z6 XL <sup>3)</sup> / Z7 XL 45 kN <sup>4)</sup>	579110 R	1.355,58	
	M 108,0 G XL (PR-3S)	Z6 XL <sup>3)</sup> / Z7 XL 45 kN <sup>4)</sup>	579111 R	1.355,58	
	M 15 S (PR-2B)	Z8	574738 R	124,51	
M 18 S (PR-2B)	Z8	574740 R	124,51		
M 22 S (PR-2B)	Z8	574742 R	124,51		
M 28 S (PR-2B)	Z8	574744 R	124,51		
M 35 S (PR-2B)	Z8	574746 R	136,96		
Pipelife RADOPRESS	TH 16*		570460	186,32	
	TH 18*		570465	186,32	
	TH 20*		570470	186,32	
	TH 26*		570475	186,32	
	TH 32		570480	186,32	
	TH 40		570485	246,99	
	TH 50 (PZ-S)		572400	645,58	
	TH 63 (PZ-S)		572405	645,58	
	TH 16 S (PR-2B)**	Z8	574782 R	124,51	
	TH 18 S (PR-2B)**	Z8	574786 R	124,51	
	TH 20 S (PR-2B)**	Z8	574788 R	124,51	
	TH 26 S (PR-2B)**	Z8	574794 R	124,51	
TH 32 S (PR-2B)	Z8	574798 R	136,96		
Pipetec Connect	TH 16*		570460	186,32	
	TH 20*		570470	186,32	
	TH 26*		570475	186,32	
	TH 32		570480	186,32	
	TH 40		570485	246,99	
	TH 50 (PZ-S)		572400	645,58	
	TH 63 (PZ-S)		572405	645,58	
	TH 16 S (PR-2B)**	Z8	574782 R	124,51	
	TH 20 S (PR-2B)**	Z8	574788 R	124,51	
	TH 26 S (PR-2B)**	Z8	574794 R	124,51	
	TH 32 S (PR-2B)	Z8	574798 R	136,96	
	PLASTICA ALFA Multypex	TH 16*		570460	186,32
TH 20*			570470	186,32	
TH 26*			570475	186,32	
TH 32			570480	186,32	
TH 16 S (PR-2B)**		Z8	574782 R	124,51	
TH 20 S (PR-2B)**		Z8	574788 R	124,51	
TH 26 S (PR-2B)**		Z8	574794 R	124,51	
TH 32 S (PR-2B)		Z8	574798 R	136,96	
PLASTICA ALFA Multypex Air		TH 16*		570460	186,32
		TH 20*		570470	186,32
		TH 26*		570475	186,32
		TH 32		570480	186,32
	TH 16 S (PR-2B)**	Z8	574782 R	124,51	
	TH 20 S (PR-2B)**	Z8	574788 R	124,51	
PLASTICA ALFA Multypex Alfa Gas	TH 16*		570460	186,32	
	TH 20*		570470	186,32	
	TH 26*		570475	186,32	
	TH 16 S (PR-2B)**	Z8	574782 R	124,51	
	TH 20 S (PR-2B)**	Z8	574788 R	124,51	
	TH 26 S (PR-2B)**	Z8	574794 R	124,51	
PLASTICA ALFA Multypex Alfa Gas protek	TH 16*		570460	186,32	
	TH 20*		570470	186,32	
	TH 26*		570475	186,32	
	TH 16 S (PR-2B)**	Z8	574782 R	124,51	
	TH 20 S (PR-2B)**	Z8	574788 R	124,51	
	TH 26 S (PR-2B)**	Z8	574794 R	124,51	
PLASTICA ALFA Multypex Plus	TH 16*		570460	186,32	
	TH 20*		570470	186,32	
	TH 26*		570475	186,32	
	TH 32		570480	186,32	
	TH 16 S (PR-2B)**	Z8	574782 R	124,51	
	TH 20 S (PR-2B)**	Z8	574788 R	124,51	
TH 26 S (PR-2B)**	Z8	574794 R	124,51		
TH 32 S (PR-2B)	Z8	574798 R	136,96		



# REMS pressing tongs REMS pressing rings

Accessories for REMS radial presses (except for REMS Mini-Press)  
and suitable radial presses of other makes

System	Pressing tongs/ pressing rings	Driven by adapter tongs	Art.-No.	€	System	Pressing tongs/ pressing rings	Driven by adapter tongs	Art.-No.	€
PLASTICA ALFA Multypex Thermo	TH 16*		570460	186,32	POLYSAN	M 15		570110	154,61
	TH 20*		570470	186,32	Handelsges.	M 18		570120	154,61
	TH 26*		570475	186,32	m.b.H. & Co KG	M 22		570130	154,61
	TH 32		570480	186,32	(Krems/Öster- reich)	M 28		570140	154,61
	TH 16 S (PR-2B)**	Z8	574782 R	124,51	M 35			570150	154,61
	TH 20 S (PR-2B)**	Z8	574788 R	124,51	POLYSAN-	M 42 (PR-3S)	Z2	572706 R	672,57
TH 26 S (PR-2B)**	Z8	574794 R	124,51	C-Stahl-Press- System M	M 54 (PR-3S)	Z2	572708 R	672,57	
TH 32 S (PR-2B)	Z8	574798 R	136,96	M 76.1 XL (PR-3S)	Z6 XL <sup>3)</sup> / Z7 XL 45 kN <sup>4)</sup>		579101 R	1.161,47	
				M 88,9 G XL (PR-3S)	Z6 XL <sup>3)</sup> / Z7 XL 45 kN <sup>4)</sup>		579110 R	1.355,58	
				M 108,0 G XL (PR-3S)	Z6 XL <sup>3)</sup> / Z7 XL 45 kN <sup>4)</sup>		579111 R	1.355,58	
				M 15 S (PR-2B)	Z8		574738 R	124,51	
				M 18 S (PR-2B)	Z8		574740 R	124,51	
				M 22 S (PR-2B)	Z8		574742 R	124,51	
				M 28 S (PR-2B)	Z8		574744 R	124,51	
				M 35 S (PR-2B)	Z8		574746 R	136,96	
				POLYSAN	M 15		570110	154,61	
				Handelsges.	M 18		570120	154,61	
				m.b.H. & Co KG	M 22		570130	154,61	
				(Krems/Öster- reich)	M 28		570140	154,61	
				M 35			570150	154,61	
				POLYSAN-	M 42 (PR-3S)	Z2	572706 R	672,57	
				Edelstahl	M 54 (PR-3S)	Z2	572708 R	672,57	
				Press-System 1.4520	M 76.1 XL (PR-3S)	Z6 XL <sup>3)</sup> / Z7 XL 45 kN <sup>4)</sup>	579101 R	1.161,47	
				M 88,9 G XL (PR-3S)	Z6 XL <sup>3)</sup> / Z7 XL 45 kN <sup>4)</sup>		579110 R	1.355,58	
				M 108,0 G XL (PR-3S)	Z6 XL <sup>3)</sup> / Z7 XL 45 kN <sup>4)</sup>		579111 R	1.355,58	
				M 15 S (PR-2B)	Z8		574738 R	124,51	
				M 18 S (PR-2B)	Z8		574740 R	124,51	
				M 22 S (PR-2B)	Z8		574742 R	124,51	
				M 28 S (PR-2B)	Z8		574744 R	124,51	
				M 35 S (PR-2B)	Z8		574746 R	136,96	
				POLYSAN	M 15		570110	154,61	
				Handelsges.	M 18		570120	154,61	
				m.b.H. & Co KG	M 22		570130	154,61	
				(Krems/Öster- reich)	M 28		570140	154,61	
				M 35			570150	154,61	
				POLYSAN-	M 42 (PR-3S)	Z2	572706 R	672,57	
				Edelstahl	M 54 (PR-3S)	Z2	572708 R	672,57	
				Press-System Gas	M 76.1 XL (PR-3S)	Z7 XL 45 kN <sup>4)</sup>	579101 R	1.161,47	
				M 88,9 G XL (PR-3S) <sup>7)</sup>	Z7 XL 45 kN <sup>4)</sup>		579110 R	1.355,58	
				M 108,0 G XL (PR-3S) <sup>7)</sup>	Z7 XL 45 kN <sup>4)</sup>		579111 R	1.355,58	
				M 15 S (PR-2B)	Z8		574738 R	124,51	
				M 18 S (PR-2B)	Z8		574740 R	124,51	
				M 22 S (PR-2B)	Z8		574742 R	124,51	
				M 28 S (PR-2B)	Z8		574744 R	124,51	
				M 35 S (PR-2B)	Z8		574746 R	136,96	
				POLYSAN	M 15		570110	154,61	
				Handelsges.	M 18		570120	154,61	
				m.b.H. & Co KG	M 22		570130	154,61	
				(Krems/Öster- reich)	M 28		570140	154,61	
				M 35			570150	154,61	
				POLYSAN-	M 42 (PR-3S)	Z2	572706 R	672,57	
				Edelstahl	M 54 (PR-3S)	Z2	572708 R	672,57	
				Press-System Wasser	M 76.1 XL (PR-3S)	Z6 XL <sup>3)</sup> / Z7 XL 45 kN <sup>4)</sup>	579101 R	1.161,47	
				M 88,9 G XL (PR-3S)	Z6 XL <sup>3)</sup> / Z7 XL 45 kN <sup>4)</sup>		579110 R	1.355,58	
				M 108,0 G XL (PR-3S)	Z6 XL <sup>3)</sup> / Z7 XL 45 kN <sup>4)</sup>		579111 R	1.355,58	
				M 15 S (PR-2B)	Z8		574738 R	124,51	
				M 18 S (PR-2B)	Z8		574740 R	124,51	
				M 22 S (PR-2B)	Z8		574742 R	124,51	
				M 28 S (PR-2B)	Z8		574744 R	124,51	
				M 35 S (PR-2B)	Z8		574746 R	136,96	
				POLYSAN	TH 14*		570455	186,32	
				Handelsges.	TH 16*		570460	186,32	
				m.b.H. & Co KG	TH 17*		570462	186,32	
				(Krems/Öster- reich)	TH 18*		570465	186,32	
				TH 20*			570470	186,32	
				POLYSAN-	TH 26*		570475	186,32	
				Press-System	TH 32		570480	186,32	
				TH 40			570485	246,99	
				TH 50 (PZ-S)			572400	645,58	
				TH 63 (PZ-S)			572405	645,58	
				THz 75 (PR-3B)	Z4		572829 R	609,25	
				TH 14 S (PR-2B)**	Z8		574778 R	124,51	
				TH 16 S (PR-2B)**	Z8		574782 R	124,51	
				TH 17 S (PR-2B)**	Z8		574784 R	124,51	
				TH 18 S (PR-2B)**	Z8		574786 R	124,51	
				TH 20 S (PR-2B)**	Z8		574788 R	124,51	
				TH 26 S (PR-2B)**	Z8		574794 R	124,51	
				TH 32 S (PR-2B)	Z8		574798 R	136,96	

Pressfitting systems for gas installations must only be pressed with pressing tongs/pressing rings which are highlighted in yellow.

Observe the national regulations. Read and observe the instructions for use and the installation instructions of the system provider/manufacturer.

\* Can also be driven by the REMS Eco-Press manual radial press, see page 185. Observe the national regulations.

\*\* Can also be driven by the REMS Eco-Press manual radial press using the Z8 adapter tongs, see page 185. Observe the national regulations.

1) Only pressing tongs from designation "108" (1<sup>st</sup> quarter of 2008), "208" (2<sup>nd</sup> quarter of 2008) etc. can be used. The designation is stamped on every pressing jaw.

2) For this pressfitting system producing a pressing joint with manual radial presses is not permitted.

3) Driven by REMS Power-Press XL ACC, see page 188.

4) Driven by REMS Akku-Press XL 45 kN 22V ACC, see page 196.

5) For fitting suitable pressing inserts.

6) Press fittings made of red bronze (Sanpress XL) must be pressed with pressing rings with press contour VR, copper fittings (Profipress XL, Profipress G XL), carbon steel (Prestabo XL) and stainless steel fittings (Sanpress Inox XL, Sanpress Inox G XL) with pressing rings with press contour VF.

7) Use pressing rings labelled "M 88.9 G" or "M 108 G" on the three pressing segments for gas installations.

8) For making press joints for operating pressure ≤ PN 10.

9) For pipes of the EN technical standard. Observe the instructions for use of the system provider/manufacturer.

10) For pipes of the ASTM technical standard. Observe the instructions for use of the system provider/manufacturer.

11) Only use pressing tongs identified by "VMP ½" G" on the pressing jaws for gas installations.

12) Previous designation: C 26 pressing tongs

The suitability of REMS pressing tools for pressfitting systems: Date 27.10.2023. For the updated situation regarding suitability status check our website:

www.rems.de > Downloads > Product catalogues, brochures > REMS Catalogue.

See page 238 for adapter tongs. Pressing tongs/pressing rings for additional pressfitting systems on request.



# REMS pressing tongs REMS pressing rings

Accessories for REMS radial presses (except for REMS Mini-Press) and suitable radial presses of other makes

System	Pressing tongs/ pressing rings	Driven by adapter tongs	Art.-No.	€	System	Pressing tongs/ pressing rings	Driven by adapter tongs	Art.-No.	€	
RIFENG U PRESS FITTING (F5)	U 14*		570760	174,33	Rubinetterie	M 15		570110	154,61	
	U 16*		570765	174,33	Bresciane	M 18		570120	154,61	
	U 18*		570770	174,33	Bonomi	M 22		570130	154,61	
	U 20*		570775	174,33	TURBO INOX GAS	M 28		570140	154,61	
	U 25*		570780	174,33		M 35		570150	154,61	
	U 32		570785	204,43		M 42 (PR-3S)	Z2	572706 R	672,57	
	U 40		570790	249,07		M 54 (PR-3S)	Z2	572708 R	672,57	
	U 50		570795	298,89		M 15 S (PR-2B)	Z8	574738 R	124,51	
	U 63 (PZ-S)		572365	645,58		M 18 S (PR-2B)	Z8	574740 R	124,51	
	U 63 (PR-3B)	Z4	572837 R	733,81		M 22 S (PR-2B)	Z8	574742 R	124,51	
	U 75 (PR-3B)	Z4	572828 R	645,58		M 28 S (PR-2B)	Z8	574744 R	124,51	
						M 35 S (PR-2B)	Z8	574746 R	136,96	
						Rubinetterie	M 15		570110	154,61
						Bresciane	M 18		570120	154,61
				Bonomi	M 22		570130	154,61		
				TURBO STEEL	M 28		570140	154,61		
				M 35		570150	154,61			
				M 42 (PR-3S)	Z2	572706 R	672,57			
				M 54 (PR-3S)	Z2	572708 R	672,57			
				M 76,1 XL (PR-3S)	Z6 XL <sup>3)</sup> / Z7 XL 45 kN <sup>4)</sup>	579101 R	1.161,47			
				M 88,9 G XL (PR-3S)	Z6 XL <sup>3)</sup> / Z7 XL 45 kN <sup>4)</sup>	579110 R	1.355,58			
				M 108,0 G XL (PR-3S)	Z6 XL <sup>3)</sup> / Z7 XL 45 kN <sup>4)</sup>	579111 R	1.355,58			
				M 15 S (PR-2B)	Z8	574738 R	124,51			
				M 18 S (PR-2B)	Z8	574740 R	124,51			
				M 22 S (PR-2B)	Z8	574742 R	124,51			
				M 28 S (PR-2B)	Z8	574744 R	124,51			
				M 35 S (PR-2B)	Z8	574746 R	136,96			
				Rubinetterie	B 14*		570845	203,40		
				Bresciane	B 16*		570850	203,40		
				Bonomi	B 18*		570855	203,40		
				TURBO PRESS	B 20*		570860	203,40		
					B 26		570870	224,16		
					B 32		570880	224,16		
					H 14*		570310	168,10		
					H 16*		570320	168,10		
					H 18*		570340	168,10		
					H 20*		570350	168,10		
					H 26*		570370	168,10		
					H 32		570380	168,10		
					TH 14*		570455	186,32		
					TH 16*		570460	186,32		
					TH 18*		570465	186,32		
					TH 20*		570470	186,32		
					TH 26*		570475	186,32		
					TH 32		570480	186,32		
					TH 40		570485	246,99		
				TH 50 (PZ-S)		572400	645,58			
				TH 63 (PZ-S)		572405	645,58			
				TH 16 S (PR-2B)**	Z8	574782 R	124,51			
				TH 20 S (PR-2B)**	Z8	574788 R	124,51			
				TH 26 S (PR-2B)**	Z8	574794 R	124,51			
				TH 32 S (PR-2B)	Z8	574798 R	136,96			
				U 14*		570760	174,33			
				U 16*		570765	174,33			
				U 18*		570770	174,33			
				U 20*		570775	174,33			
				U 26* <sup>12)</sup>		570750	204,43			
				U 32		570785	204,43			
				Rubinetterie	TH 16*		570460	186,32		
				Bresciane	TH 20*		570470	186,32		
				Bonomi	TH 26*		570475	186,32		
				TURBO PRESS GAS	TH 32		570480	186,32		
					TH 16 S (PR-2B)**	Z8	574782 R	124,51		
					TH 20 S (PR-2B)**	Z8	574788 R	124,51		
					TH 26 S (PR-2B)**	Z8	574794 R	124,51		
					TH 32 S (PR-2B)	Z8	574798 R	136,96		

Pressfitting systems for gas installations must only be pressed with pressing tongs/pressing rings which are highlighted in yellow. Observe the national regulations. Read and observe the instructions for use and the installation instructions of the system provider/manufacturer.

- \* Can also be driven by the REMS Eco-Press manual radial press, see page 185. Observe the national regulations.
- \*\* Can also be driven by the REMS Eco-Press manual radial press using the Z8 adapter tongs, see page 185. Observe the national regulations.
- <sup>1)</sup> Only pressing tongs from designation "108" (1<sup>st</sup> quarter of 2008), "208" (2<sup>nd</sup> quarter of 2008) etc. can be used. The designation is stamped on every pressing jaw.
- <sup>2)</sup> For this pressfitting system producing a pressing joint with manual radial presses is not permitted.
- <sup>3)</sup> Driven by REMS Power-Press XL ACC, see page 188.
- <sup>4)</sup> Driven by REMS Akku-Press XL 45 kN 22V ACC, see page 196.
- <sup>5)</sup> For taking suitable pressing inserts.
- <sup>6)</sup> Press fittings made of red bronze (Sanpress XL) must be pressed with pressing rings with press contour VR, copper fittings (Profipress XL, Profipress G XL), carbon steel (Prestabo XL) and stainless steel fittings (Sanpress Inox XL, Sanpress Inox G XL) with pressing rings with press contour VF.
- <sup>7)</sup> Use pressing rings labelled "M 88.9 G" or "M 108 G" on the three pressing segments for gas installations.
- <sup>8)</sup> For making press joints for operating pressure ≤ PN 10.
- <sup>9)</sup> For pipes of the EN technical standard. Observe the instructions for use of the system provider/manufacturer.
- <sup>10)</sup> For pipes of the ASTM technical standard. Observe the instructions for use of the system provider/manufacturer.
- <sup>11)</sup> Only use pressing tongs identified by "VMP ½" G" on the pressing jaws for gas installations.
- <sup>12)</sup> Previous designation: C 26 pressing tongs

The suitability of REMS pressing tools for pressfitting systems: Date 27.10.2023. For the updated situation regarding suitability status check our website: [www.rems.de](http://www.rems.de) > Downloads > Product catalogues, brochures > REMS Catalogue. See page 238 for adapter tongs. Pressing tongs/pressing rings for additional pressfitting systems on request.



**REMS pressing tongs**  
**REMS pressing rings**

Accessories for REMS radial presses (except for REMS Mini-Press) and suitable radial presses of other makes

System	Pressing tongs / pressing rings	Driven by adapter tongs	Art.-No.	€	System	Pressing tongs / pressing rings	Driven by adapter tongs	Art.-No.	€
SANHA-NiroSan	SA 15		570935	185,75	SANHA	SA 15		570935	185,75
SF Presssystem	SA 18		570940	185,75	NiroTherm	SA 18		570940	185,75
Serie 19000	SA 22		570945	185,75	Industry	SA 22		570945	185,75
(silicone free)	SA 28		570950	185,75	Serie 98000	SA 28		570950	185,75
	SA 35		570955	185,75		SA 35		570955	185,75
	M 15		570110	154,61		M 15		570110	154,61
	M 18		570120	154,61		M 18		570120	154,61
	M 22		570130	154,61		M 22		570130	154,61
	M 28		570140	154,61		M 28		570140	154,61
	M 35		570150	154,61		M 35		570150	154,61
	M 42 (PR-3S)	Z2	572706 R	672,57		M 42 (PR-3S)	Z2	572706 R	672,57
	M 54 (PR-3S)	Z2	572708 R	672,57		M 54 (PR-3S)	Z2	572708 R	672,57
	M 76,1 XL (PR-3S)	Z6 XL <sup>3)</sup> / Z7 XL 45kN <sup>4)</sup>	579101 R	1.161,47		M 76,1 XL (PR-3S)	Z6 XL <sup>3)</sup> / Z7 XL 45kN <sup>4)</sup>	579101 R	1.161,47
	M 88,9 G XL (PR-3S)	Z6 XL <sup>3)</sup> / Z7 XL 45kN <sup>4)</sup>	579110 R	1.355,58		M 88,9 G XL (PR-3S)	Z6 XL <sup>3)</sup> / Z7 XL 45kN <sup>4)</sup>	579110 R	1.355,58
	M 108,0 G XL (PR-3S)	Z6 XL <sup>3)</sup> / Z7 XL 45kN <sup>4)</sup>	579111 R	1.355,58		M 108,0 G XL (PR-3S)	Z6 XL <sup>3)</sup> / Z7 XL 45kN <sup>4)</sup>	579111 R	1.355,58
	M 15 S (PR-2B)	Z8	574738 R	124,51		M 15 S (PR-2B)	Z8	574738 R	124,51
	M 18 S (PR-2B)	Z8	574740 R	124,51		M 18 S (PR-2B)	Z8	574740 R	124,51
	M 22 S (PR-2B)	Z8	574742 R	124,51		M 22 S (PR-2B)	Z8	574742 R	124,51
	M 28 S (PR-2B)	Z8	574744 R	124,51		M 28 S (PR-2B)	Z8	574744 R	124,51
	M 35 S (PR-2B)	Z8	574746 R	136,96		M 35 S (PR-2B)	Z8	574746 R	136,96
	V 15		570115	154,61		V 15		570115	154,61
	V 18		570125	154,61		V 18		570125	154,61
	V 22		570135	154,61		V 22		570135	154,61
	V 28		570145	154,61		V 28		570145	154,61
	V 35		570155	154,61		V 35		570155	154,61
	V 42		570165	360,13		V 42		570165	360,13
	V 42 (PR-2B)	Z2	572850 R	322,77		V 42 (PR-2B)	Z2	572850 R	322,77
	V 54		570175	370,51		V 54		570175	370,51
	V 54 (PR-2B)	Z2	572851 R	348,72		V 54 (PR-2B)	Z2	572851 R	348,72
	V 15 S (PR-2B)	Z8	574752 R	124,51		V 15 S (PR-2B)	Z8	574752 R	124,51
	V 18 S (PR-2B)	Z8	574756 R	124,51		V 18 S (PR-2B)	Z8	574756 R	124,51
	V 22 S (PR-2B)	Z8	574758 R	124,51		V 22 S (PR-2B)	Z8	574758 R	124,51
	V 28 S (PR-2B)	Z8	574760 R	124,51		V 28 S (PR-2B)	Z8	574760 R	124,51
	V 35 S (PR-2B)	Z8	574762 R	136,96		V 35 S (PR-2B)	Z8	574762 R	136,96
SANHA	SA 15		570935	185,75	SANHA-Press	SA 12		570930	269,83
NiroTherm	SA 18		570940	185,75	Chrom	SA 15		570935	185,75
Serie 91000	SA 22		570945	185,75	Serie 16000	SA 18		570940	185,75
	SA 28		570950	185,75		SA 22		570945	185,75
	SA 35		570955	185,75		SA 28		570950	185,75
	M 15		570110	154,61		M 12		570100	154,61
	M 18		570120	154,61		M 15		570110	154,61
	M 22		570130	154,61		M 18		570120	154,61
	M 28		570140	154,61		M 22		570130	154,61
	M 35		570150	154,61		M 28		570140	154,61
	M 42 (PR-3S)	Z2	572706 R	672,57		M 12 S (PR-2B)	Z8	574736 R	124,51
	M 54 (PR-3S)	Z2	572708 R	672,57		M 15 S (PR-2B)	Z8	574738 R	124,51
	M 76,1 XL (PR-3S)	Z6 XL <sup>3)</sup> / Z7 XL 45kN <sup>4)</sup>	579101 R	1.161,47		M 18 S (PR-2B)	Z8	574740 R	124,51
	M 88,9 G XL (PR-3S)	Z6 XL <sup>3)</sup> / Z7 XL 45kN <sup>4)</sup>	579110 R	1.355,58		M 22 S (PR-2B)	Z8	574742 R	124,51
	M 108,0 G XL (PR-3S)	Z6 XL <sup>3)</sup> / Z7 XL 45kN <sup>4)</sup>	579111 R	1.355,58		M 28 S (PR-2B)	Z8	574744 R	124,51
	M 15 S (PR-2B)	Z8	574738 R	124,51		V 12		570107	154,61
	M 18 S (PR-2B)	Z8	574740 R	124,51		V 15		570115	154,61
	M 22 S (PR-2B)	Z8	574742 R	124,51		V 18		570125	154,61
	M 28 S (PR-2B)	Z8	574744 R	124,51		V 22		570135	154,61
	M 35 S (PR-2B)	Z8	574746 R	136,96		V 28		570145	154,61
	V 15		570115	154,61		V 12 S (PR-2B)	Z8	574748 R	124,51
	V 18		570125	154,61		V 15 S (PR-2B)	Z8	574752 R	124,51
	V 22		570135	154,61		V 18 S (PR-2B)	Z8	574756 R	124,51
	V 28		570145	154,61		V 22 S (PR-2B)	Z8	574758 R	124,51
	V 35		570155	154,61		V 28 S (PR-2B)	Z8	574760 R	124,51
	V 42		570165	360,13					
	V 42 (PR-2B)	Z2	572850 R	322,77					
	V 54		570175	370,51					
	V 54 (PR-2B)	Z2	572851 R	348,72					
	V 15 S (PR-2B)	Z8	574752 R	124,51					
	V 18 S (PR-2B)	Z8	574756 R	124,51					
	V 22 S (PR-2B)	Z8	574758 R	124,51					
	V 28 S (PR-2B)	Z8	574760 R	124,51					
	V 35 S (PR-2B)	Z8	574762 R	136,96					

Pressfitting systems for gas installations must only be pressed with pressing tongs/pressing rings which are highlighted in yellow.

Observe the national regulations. Read and observe the instructions for use and the installation instructions of the system provider/manufacture.

\* Can also be driven by the REMS Eco-Press manual radial press, see page 185. Observe the national regulations.

\*\* Can also be driven by the REMS Eco-Press manual radial press using the Z8 adapter tongs, see page 185. Observe the national regulations.

<sup>1)</sup> Only pressing tongs from designation "108" (1<sup>st</sup> quarter of 2008), "208" (2<sup>nd</sup> quarter of 2008) etc. can be used. The designation is stamped on every pressing jaw.

<sup>2)</sup> For this pressfitting system producing a pressing joint with manual radial presses is not permitted.

<sup>3)</sup> Driven by REMS Power-Press XL ACC, see page 188.

<sup>4)</sup> Driven by REMS Akku-Press XL 45kN 22V ACC, see page 196.

<sup>5)</sup> For taking suitable pressing inserts.

<sup>6)</sup> Press fittings made of red bronze (Sanpress XL) must be pressed with pressing rings with press contour VR, copper fittings (Profipress XL, Profipress G XL), carbon steel (Prestabo XL) and stainless steel fittings (Sanpress Inox XL, Sanpress Inox G XL) with pressing rings with press contour VF.

<sup>7)</sup> Use pressing rings labelled "M 88.9 G" or "M 108 G" on the three pressing segments for gas installations.

<sup>8)</sup> For making press joints for operating pressure ≤ PN 10.

<sup>9)</sup> For pipes of the EN technical standard. Observe the instructions for use of the system provider/manufacture.

<sup>10)</sup> For pipes of the ASTM technical standard. Observe the instructions for use of the system provider/manufacture.

<sup>11)</sup> Only use pressing tongs identified by "VMP ½" G" on the pressing jaws for gas installations.

<sup>12)</sup> Previous designation: C 26 pressing tongs

The suitability of REMS pressing tools for pressfitting systems: Date 27.10.2023. For the updated situation regarding suitability status check our website:

www.rems.de > Downloads > Product catalogues, brochures > REMS Catalogue.

See page 238 for adapter tongs. Pressing tongs/pressing rings for additional pressfitting systems on request.

# REMS pressing tongs

## REMS pressing rings

Accessories for REMS radial presses (except for REMS Mini-Press) and suitable radial presses of other makes

System	Pressing tongs / pressing rings	Driven by adapter tongs	Art.-No.	€	System	Pressing tongs / pressing rings	Driven by adapter tongs	Art.-No.	€	
SANHA-Press GAS Pressfittings Serie 10000/ Serie 11000	SA 12		570930	269,83	SANHA-Press SOLAR Pressfittings Serie 12000/ Serie 13000	SA 12		570930	269,83	
	SA 14		570932	269,83		SA 15		570935	185,75	
	SA 15		570935	185,75		SA 18		570940	185,75	
	SA 16		570937	185,75		SA 22		570945	185,75	
	SA 18		570940	185,75		SA 28		570950	185,75	
	SA 22		570945	185,75		SA 35		570955	185,75	
	SA 28		570950	185,75		M 12		570100	154,61	
	SA 35		570955	185,75		M 15		570110	154,61	
	M 12		570100	154,61		M 18		570120	154,61	
	M 15		570110	154,61		M 22		570130	154,61	
	M 18		570120	154,61		M 28		570140	154,61	
	M 22		570130	154,61		M 35		570150	154,61	
	M 28		570140	154,61		M 42 (PR-3S)	Z2	572706 R	672,57	
	M 35		570150	154,61		M 54 (PR-3S)	Z2	572708 R	672,57	
	M 42 (PR-3S)	Z2	572706 R	672,57		XP 64,0 XL (PR-3S)	Z6 XL <sup>3)</sup> / Z7 XL 45 kN <sup>4)</sup>	579100 R	1.056,63	
	M 54 (PR-3S)	Z2	572708 R	672,57		XP 66,7 XL (PR-3S)	Z6 XL <sup>3)</sup> / Z7 XL 45 kN <sup>4)</sup>	579108 R	1.161,47	
	M 12 S (PR-2B)	Z8	574736 R	124,51		M 66,7 XL (PR-3S)	Z6 XL <sup>3)</sup> / Z7 XL 45 kN <sup>4)</sup>	579107 R	1.161,47	
	M 15 S (PR-2B)	Z8	574738 R	124,51		M 76,1 XL (PR-3S)	Z6 XL <sup>3)</sup> / Z7 XL 45 kN <sup>4)</sup>	579101 R	1.161,47	
	M 18 S (PR-2B)	Z8	574740 R	124,51		M 88,9 G XL (PR-3S)	Z6 XL <sup>3)</sup> / Z7 XL 45 kN <sup>4)</sup>	579110 R	1.355,58	
	M 22 S (PR-2B)	Z8	574742 R	124,51		M 108,0 G XL (PR-3S)	Z6 XL <sup>3)</sup> / Z7 XL 45 kN <sup>4)</sup>	579111 R	1.355,58	
	M 28 S (PR-2B)	Z8	574744 R	124,51		M 12 S (PR-2B)	Z8	574736 R	124,51	
	M 35 S (PR-2B)	Z8	574746 R	136,96		M 15 S (PR-2B)	Z8	574738 R	124,51	
	V 12		570107	154,61		M 18 S (PR-2B)	Z8	574740 R	124,51	
	V 14		570112	154,61		M 22 S (PR-2B)	Z8	574742 R	124,51	
	VG 14		570132	154,61		M 28 S (PR-2B)	Z8	574744 R	124,51	
	V 15		570115	154,61		M 35 S (PR-2B)	Z8	574746 R	136,96	
	V 16		570117	154,61		V 12		570107	154,61	
	VG 16		570137	154,61		V 15		570115	154,61	
	V 18		570125	154,61		V 18		570125	154,61	
	V 22		570135	154,61		V 22		570135	154,61	
	V 28		570145	154,61		V 28		570145	154,61	
	V 35		570155	154,61		V 35		570155	154,61	
	V 42		570165	360,13		V 42		570165	360,13	
	V 42 (PR-2B)	Z2	572850 R	322,77		V 42 (PR-2B)	Z2	572850 R	322,77	
	V 54		570175	370,51		V 54		570175	370,51	
	V 54 (PR-2B)	Z2	572851 R	348,72		V 54 (PR-2B)	Z2	572851 R	348,72	
	V 12 S (PR-2B)	Z8	574748 R	124,51		V 12 S (PR-2B)	Z8	574748 R	124,51	
	VG 14 S (PR-2B)	Z8	574750 R	124,51		V 15 S (PR-2B)	Z8	574752 R	124,51	
	V 15 S (PR-2B)	Z8	574752 R	124,51		V 18 S (PR-2B)	Z8	574756 R	124,51	
	VG 16 S (PR-2B)	Z8	574754 R	124,51		V 22 S (PR-2B)	Z8	574758 R	124,51	
	V 18 S (PR-2B)	Z8	574756 R	124,51		V 28 S (PR-2B)	Z8	574760 R	124,51	
	V 22 S (PR-2B)	Z8	574758 R	124,51		V 35 S (PR-2B)	Z8	574762 R	136,96	
	V 28 S (PR-2B)	Z8	574760 R	124,51		SANHA PURAPRESS Serie 8000	SA 12		570930	269,83
	V 35 S (PR-2B)	Z8	574762 R	136,96			SA 14		570932	269,83
	SA 12		570930	269,83			SA 15		570935	185,75
SA 14		570932	269,83	SA 16			570937	185,75		
SA 15		570935	185,75	SA 18			570940	185,75		
SA 16		570937	185,75	SA 22			570945	185,75		
SA 18		570940	185,75	SA 28			570950	185,75		
SA 22		570945	185,75	SA 35			570955	185,75		
SA 28		570950	185,75	M 12			570100	154,61		
SA 35		570955	185,75	M 15 <sup>1)</sup>			570110	154,61		
M 12		570100	154,61	M 18 <sup>1)</sup>			570120	154,61		
M 15		570110	154,61	M 22 <sup>1)</sup>			570130	154,61		
M 18		570120	154,61	M 28 <sup>1)</sup>			570140	154,61		
M 22		570130	154,61	M 35 <sup>1)</sup>			570150	154,61		
M 28		570140	154,61	M 42 (PR-3S)	Z2		572706 R	672,57		
M 35		570150	154,61	M 54 (PR-3S)	Z2		572708 R	672,57		
M 42 (PR-3S)	Z2	572706 R	672,57	XP 64,0 XL (PR-3S)	Z6 XL <sup>3)</sup> / Z7 XL 45 kN <sup>4)</sup>		579100 R	1.056,63		
M 54 (PR-3S)	Z2	572708 R	672,57	XP 66,7 XL (PR-3S)	Z6 XL <sup>3)</sup> / Z7 XL 45 kN <sup>4)</sup>		579108 R	1.161,47		
XP 64,0 XL (PR-3S)	Z6 XL <sup>3)</sup> / Z7 XL 45 kN <sup>4)</sup>	579100 R	1.056,63	M 66,7 XL (PR-3S)	Z6 XL <sup>3)</sup> / Z7 XL 45 kN <sup>4)</sup>		579107 R	1.161,47		
XP 66,7 XL (PR-3S)	Z6 XL <sup>3)</sup> / Z7 XL 45 kN <sup>4)</sup>	579108 R	1.161,47	M 76,1 XL (PR-3S)	Z6 XL <sup>3)</sup> / Z7 XL 45 kN <sup>4)</sup>		579101 R	1.161,47		
M 66,7 XL (PR-3S)	Z6 XL <sup>3)</sup> / Z7 XL 45 kN <sup>4)</sup>	579107 R	1.161,47	M 88,9 G XL (PR-3S)	Z6 XL <sup>3)</sup> / Z7 XL 45 kN <sup>4)</sup>		579110 R	1.355,58		
M 76,1 XL (PR-3S)	Z6 XL <sup>3)</sup> / Z7 XL 45 kN <sup>4)</sup>	579101 R	1.161,47	M 108,0 G XL (PR-3S)	Z6 XL <sup>3)</sup> / Z7 XL 45 kN <sup>4)</sup>		579111 R	1.355,58		
M 88,9 G XL (PR-3S)	Z6 XL <sup>3)</sup> / Z7 XL 45 kN <sup>4)</sup>	579110 R	1.355,58	M 12 S (PR-2B)	Z8		574736 R	124,51		
M 108,0 G XL (PR-3S)	Z6 XL <sup>3)</sup> / Z7 XL 45 kN <sup>4)</sup>	579111 R	1.355,58	M 15 S (PR-2B)	Z8		574738 R	124,51		
M 12 S (PR-2B)	Z8	574736 R	124,51	M 18 S (PR-2B)	Z8		574740 R	124,51		
M 15 S (PR-2B)	Z8	574738 R	124,51	M 22 S (PR-2B)	Z8		574742 R	124,51		
M 18 S (PR-2B)	Z8	574740 R	124,51	M 28 S (PR-2B)	Z8		574744 R	124,51		
M 22 S (PR-2B)	Z8	574742 R	124,51	M 35 S (PR-2B)	Z8		574746 R	136,96		
M 28 S (PR-2B)	Z8	574744 R	124,51	V 12			570107	154,61		
M 35 S (PR-2B)	Z8	574746 R	136,96	V 14			570112	154,61		
V 12		570107	154,61	VG 14			570132	154,61		
V 14		570112	154,61	V 15			570115	154,61		
VG 14		570132	154,61	V 16			570117	154,61		
V 15		570115	154,61	VG 16			570137	154,61		
V 16		570117	154,61	V 18			570125	154,61		
VG 16		570137	154,61	V 22			570135	154,61		
V 18		570125	154,61	V 28			570145	154,61		
V 22		570135	154,61	V 35			570155	154,61		
V 28		570145	154,61	V 42			570165	360,13		
V 35		570155	154,61	V 42 (PR-2B)	Z2		572850 R	322,77		
V 42		570165	360,13	V 54			570175	370,51		
V 42 (PR-2B)	Z2	572850 R	322,77	V 54 (PR-2B)	Z2		572851 R	348,72		
V 54		570175	370,51	V 12 S (PR-2B)	Z8		574748 R	124,51		
V 54 (PR-2B)	Z2	572851 R	348,72	VG 14 S (PR-2B)	Z8		574750 R	124,51		
V 12 S (PR-2B)	Z8	574748 R	124,51	V 15 S (PR-2B)	Z8		574752 R	124,51		
VG 14 S (PR-2B)	Z8	574750 R	124,51	VG 16 S (PR-2B)	Z8	574754 R	124,51			
V 15 S (PR-2B)	Z8	574752 R	124,51	V 18 S (PR-2B)	Z8	574756 R	124,51			
VG 16 S (PR-2B)	Z8	574754 R	124,51	V 22 S (PR-2B)	Z8	574758 R	124,51			
V 18 S (PR-2B)	Z8	574756 R	124,51	V 28 S (PR-2B)	Z8	574760 R	124,51			
V 22 S (PR-2B)	Z8	574758 R	124,51	V 35 S (PR-2B)	Z8	574762 R	136,96			
V 28 S (PR-2B)	Z8	574760 R	124,51							
V 35 S (PR-2B)	Z8	574762 R	136,96							

**REMS pressing tongs**  
**REMS pressing rings**

Accessories for REMS radial presses (except for REMS Mini-Press)  
and suitable radial presses of other makes

System	Pressing tongs / pressing rings	Driven by adapter tongs	Art.-No.	€	
SANHA-Therm Serie 24000	SA 12		570930	269,83	
	SA 15		570935	185,75	
	SA 18		570940	185,75	
	SA 22		570945	185,75	
	SA 28		570950	185,75	
	SA 35		570955	185,75	
	M 12		570100	154,61	
	M 15		570110	154,61	
	M 18		570120	154,61	
	M 22		570130	154,61	
	M 28		570140	154,61	
	M 35		570150	154,61	
	M 42 (PR-3S)	Z2	572706 R	672,57	
	M 54 (PR-3S)	Z2	572708 R	672,57	
	XP 66,7 XL (PR-3S)	Z6 XL <sup>3)</sup> / Z7 XL 45kN <sup>4)</sup>	579108 R	1.161,47	
	M 66,7 XL (PR-3S)	Z6 XL <sup>3)</sup> / Z7 XL 45kN <sup>4)</sup>	579107 R	1.161,47	
	M 76,1 XL (PR-3S)	Z6 XL <sup>3)</sup> / Z7 XL 45kN <sup>4)</sup>	579101 R	1.161,47	
	M 88,9 G XL (PR-3S)	Z6 XL <sup>3)</sup> / Z7 XL 45kN <sup>4)</sup>	579110 R	1.355,58	
	M 108,0 G XL (PR-3S)	Z6 XL <sup>3)</sup> / Z7 XL 45kN <sup>4)</sup>	579111 R	1.355,58	
	M 12 S (PR-2B)	Z8	574736 R	124,51	
	M 15 S (PR-2B)	Z8	574738 R	124,51	
	M 18 S (PR-2B)	Z8	574740 R	124,51	
	M 22 S (PR-2B)	Z8	574742 R	124,51	
	M 28 S (PR-2B)	Z8	574744 R	124,51	
	M 35 S (PR-2B)	Z8	574746 R	136,96	
	V 12		570107	154,61	
	V 15		570115	154,61	
	V 18		570125	154,61	
	V 22		570135	154,61	
	V 28		570145	154,61	
	V 35		570155	154,61	
	V 42		570165	360,13	
	V 42 (PR-2B)	Z2	572850 R	322,77	
	V 54		570175	370,51	
	V 54 (PR-2B)	Z2	572851 R	348,72	
	V 12 S (PR-2B)	Z8	574748 R	124,51	
	V 15 S (PR-2B)	Z8	574752 R	124,51	
	V 18 S (PR-2B)	Z8	574756 R	124,51	
	V 22 S (PR-2B)	Z8	574758 R	124,51	
	V 28 S (PR-2B)	Z8	574760 R	124,51	
	V 35 S (PR-2B)	Z8	574762 R	136,96	
	SANHA-Therm Industry Serie 28000	SA 12		570930	269,83
		SA 15		570935	185,75
SA 18			570940	185,75	
SA 22			570945	185,75	
SA 28			570950	185,75	
SA 35			570955	185,75	
M 12			570100	154,61	
M 15			570110	154,61	
M 18			570120	154,61	
M 22			570130	154,61	
M 28			570140	154,61	
M 35			570150	154,61	
M 42 (PR-3S)		Z2	572706 R	672,57	
M 54 (PR-3S)		Z2	572708 R	672,57	
XP 66,7 XL (PR-3S)		Z6 XL <sup>3)</sup> / Z7 XL 45kN <sup>4)</sup>	579108 R	1.161,47	
M 66,7 XL (PR-3S)		Z6 XL <sup>3)</sup> / Z7 XL 45kN <sup>4)</sup>	579107 R	1.161,47	
M 76,1 XL (PR-3S)		Z6 XL <sup>3)</sup> / Z7 XL 45kN <sup>4)</sup>	579101 R	1.161,47	
M 88,9 G XL (PR-3S)		Z6 XL <sup>3)</sup> / Z7 XL 45kN <sup>4)</sup>	579110 R	1.355,58	
M 108,0 G XL (PR-3S)		Z6 XL <sup>3)</sup> / Z7 XL 45kN <sup>4)</sup>	579111 R	1.355,58	
M 12 S (PR-2B)		Z8	574736 R	124,51	
M 15 S (PR-2B)		Z8	574738 R	124,51	
M 18 S (PR-2B)		Z8	574740 R	124,51	
M 22 S (PR-2B)		Z8	574742 R	124,51	
M 28 S (PR-2B)		Z8	574744 R	124,51	
M 35 S (PR-2B)		Z8	574746 R	136,96	
V 12			570107	154,61	
V 15			570115	154,61	
V 18			570125	154,61	
V 22			570135	154,61	
V 28			570145	154,61	
V 35			570155	154,61	
V 42			570165	360,13	
V 42 (PR-2B)		Z2	572850 R	322,77	
V 54			570175	370,51	
V 54 (PR-2B)		Z2	572851 R	348,72	
V 12 S (PR-2B)		Z8	574748 R	124,51	
V 15 S (PR-2B)		Z8	574752 R	124,51	
V 18 S (PR-2B)		Z8	574756 R	124,51	
V 22 S (PR-2B)		Z8	574758 R	124,51	
V 28 S (PR-2B)		Z8	574760 R	124,51	
V 35 S (PR-2B)		Z8	574762 R	136,96	

System	Pressing tongs / pressing rings	Driven by adapter tongs	Art.-No.	€	
SANITOP PERMATUBO INOX	M 15		570110	154,61	
	M 18 <sup>1)</sup>		570120	154,61	
	M 22		570130	154,61	
	M 28 <sup>1)</sup>		570140	154,61	
	M 35		570150	154,61	
	M 35 (PR-3S)	Z2	572727 R	672,57	
	M 42 (PZ-4G)		570160	498,19	
	M 54 (PZ-4G)		570170	498,19	
	M 42 (PR-3S)	Z2	572706 R	672,57	
	M 54 (PR-3S)	Z2	572708 R	672,57	
	M 76,1 XL (PR-3S)	Z6 XL <sup>3)</sup> / Z7 XL 45kN <sup>4)</sup>	579101 R	1.161,47	
	M 88,9 G XL (PR-3S)	Z6 XL <sup>3)</sup> / Z7 XL 45kN <sup>4)</sup>	579110 R	1.355,58	
	M 108,0 G XL (PR-3S)	Z6 XL <sup>3)</sup> / Z7 XL 45kN <sup>4)</sup>	579111 R	1.355,58	
	M 15 S (PR-2B)	Z8	574738 R	124,51	
	M 18 S (PR-2B)	Z8	574740 R	124,51	
	M 22 S (PR-2B)	Z8	574742 R	124,51	
	SANPRO THPRESS	M 28 S (PR-2B)	Z8	574744 R	124,51
M 35 S (PR-2B)		Z8	574746 R	136,96	
TH 16*			570460	186,32	
TH 20*			570470	186,32	
TH 26*			570475	186,32	
TH 32			570480	186,32	
TH 16 S (PR-2B)**		Z8	574782 R	124,51	
TH 20 S (PR-2B)**		Z8	574788 R	124,51	
TH 26 S (PR-2B)**		Z8	574794 R	124,51	
TH 32 S (PR-2B)**		Z8	574798 R	136,96	
SATEC SK VITerm	TH 16*		570460	186,32	
	TH 18*		570465	186,32	
	TH 20*		570470	186,32	
	TH 26*		570475	186,32	
	TH 32		570480	186,32	
	U 40		570790	249,07	
	U 50		570795	298,89	
	U 63 (PZ-S)		572365	645,58	
	TH 16*		570460	186,32	
	TH 20*		570470	186,32	
SAVEUR REFLEX PEX Water	TH 25*		570495	186,32	
	TH 32		570480	186,32	
	TH 16*		570460	186,32	
SAVEUR REFLEX PEX-AL-PEX Gas	TH 20*		570470	186,32	
	TH 25*		570495	186,32	
	TH 32		570480	186,32	
	TH 14*		570455	186,32	
Schütz duo-flex tri-o-flex	TH 16*		570460	186,32	
	TH 17*		570462	186,32	
	TH 20*		570470	186,32	
	TH 25*		570495	186,32	
	TH 16 S (PR-2B)**	Z8	574782 R	124,51	
	TH 20 S (PR-2B)**	Z8	574788 R	124,51	
Schwer Fittings AQUApress	M 12		570100	154,61	
	M 15		570110	154,61	
	M 18		570120	154,61	
	M 22		570130	154,61	
	M 28		570140	154,61	
	M 35		570150	154,61	
	M 42 (PZ-4G)		570160	498,19	
	M 54 (PZ-4G)		570170	498,19	
	M 42 (PR-3S)	Z2	572706 R	672,57	
	M 54 (PR-3S)	Z2	572708 R	672,57	
	M 12 S (PR-2B)	Z8	574736 R	124,51	
	M 15 S (PR-2B)	Z8	574738 R	124,51	
SEPPelfricke	M 18 S (PR-2B)	Z8	574740 R	124,51	
	M 22 S (PR-2B)	Z8	574742 R	124,51	
	M 28 S (PR-2B)	Z8	574744 R	124,51	
	M 35 S (PR-2B)	Z8	574746 R	136,96	
	> Aalberts integrated piping systems				
	SESTA SESTA GAS	TH 14*		570455	186,32
		TH 16*		570460	186,32
		TH 20*		570470	186,32
TH 26*			570475	186,32	
TH 32			570480	186,32	

Pressfitting systems for gas installations must only be pressed with pressing tongs/pressing rings which are highlighted in yellow. Observe the national regulations. Read and observe the instructions for use and the installation instructions of the system provider/manufacturer.

- \* Can also be driven by the REMS Eco-Press manual radial press, see page 185. Observe the national regulations.
- \*\* Can also be driven by the REMS Eco-Press manual radial press using the Z8 adapter tongs, see page 185. Observe the national regulations.
- 1) Only pressing tongs from designation "108" (1<sup>st</sup> quarter of 2008), "208" (2<sup>nd</sup> quarter of 2008) etc. can be used. The designation is stamped on every pressing jaw.
- 2) For this pressfitting system producing a pressing joint with manual radial presses is not permitted.
- 3) Driven by REMS Power-Press XL ACC, see page 188.
- 4) Driven by REMS Akku-Press XL 45kN 22V ACC, see page 196.
- 5) For taking suitable pressing inserts.
- 6) Press fittings made of red bronze (Sanpress XL) must be pressed with pressing rings with press contour VR, copper fittings (Profipress XL, Profipress G XL), carbon steel (Prestabo XL) and stainless steel fittings (Sanpress Inox XL, Sanpress Inox G XL) with pressing rings with press contour VF.
- 7) Use pressing rings labelled "M 88.9 G" or "M 108 G" on the three pressing segments for gas installations.
- 8) For making press joints for operating pressure ≤ PN 10.
- 9) For pipes of the EN technical standard. Observe the instructions for use of the system provider/manufacturer.
- 10) For pipes of the ASTM technical standard. Observe the instructions for use of the system provider/manufacturer.
- 11) Only use pressing tongs identified by "VMP ½" G" on the pressing jaws for gas installations.
- 12) Previous designation: C 26 pressing tongs

The suitability of REMS pressing tools for pressfitting systems: Date 27.10.2023. For the updated situation regarding suitability status check our website: [www.rems.de](http://www.rems.de) > Downloads > Product catalogues, brochures > REMS Catalogue. See page 238 for adapter tongs. Pressing tongs/pressing rings for additional pressfitting systems on request.

System	Pressing tongs / pressing rings	Driven by adapter tongs	Art.-No.	€	
SESTA Sistema multistrato	H 16*		570320	168,10	
	H 20*		570350	168,10	
	TH 14*		570455	186,32	
	TH 16*		570460	186,32	
	TH 18*		570465	186,32	
	TH 20*		570470	186,32	
	TH 26*		570475	186,32	
	TH 32		570480	186,32	
	TH 40		570485	246,99	
	TH 50 (PZ-S)		572400	645,58	
	TH 63 (PZ-S)		572405	645,58	
	U 16*		570765	174,33	
	U 20*		570775	174,33	
	SIGMA LI Premium	TH 16*		570460	186,32
		TH 20*		570470	186,32
		TH 25*		570495	186,32
TH 32			570480	186,32	
TH 16 S (PR-2B)**		Z8	574782 R	124,51	
TH 20 S (PR-2B)**		Z8	574788 R	124,51	
TH 25 S (PR-2B)**		Z8	574792 R	124,51	
TH 32 S (PR-2B)		Z8	574798 R	136,96	
U 16*			570765	174,33	
U 20*			570775	174,33	
SLOVARM PEX-THERM	U 16*		570765	174,33	
	U 20*		570775	174,33	
	H 26*		570370	168,10	
	U 32		570785	204,43	
	H 16*		570320	168,10	
	H 20*		570350	168,10	
	H 26*		570370	168,10	
	H 32		570380	168,10	
	STANDARD HIDRAULICA MultiStandard	H 16*		570320	168,10
		H 20*		570350	168,10
H 25*			570360	168,10	
H 32			570380	168,10	
RFz 16*			571325	194,05	
RFz 20*			571330	194,05	
RFz 25			571335	194,05	
RFz 32			571340	194,05	
TH 16*			570460	186,32	
TH 20*			570470	186,32	
TH 25*			570495	186,32	
TH 32			570480	186,32	
TH 16 S (PR-2B)**		Z8	574782 R	124,51	
TH 20 S (PR-2B)**		Z8	574788 R	124,51	
TH 25 S (PR-2B)**		Z8	574792 R	124,51	
TH 32 S (PR-2B)		Z8	574798 R	136,96	
U 16*			570765	174,33	
U 18*			570770	174,33	
U 20*			570775	174,33	
U 25*			570780	174,33	
U 32			570785	204,43	
U 40			570790	249,07	
U 50		570795	298,89		
U 63 (PR-3B)	Z4	572837 R	733,81		
U 63 (PZ-S)		572365	645,58		
steeltrade Presssystem Edelstahl Kontur M	M 15		570110	154,61	
	M 18 <sup>1)</sup>		570120	154,61	
	M 22		570130	154,61	
	M 28 <sup>1)</sup>		570140	154,61	
	M 35		570150	154,61	
	M 42 (PR-3S)	Z2	572706 R	672,57	
	M 54 (PR-3S)	Z2	572708 R	672,57	
	M 76,1 XL (PR-3S)	Z6 XL <sup>2)</sup> / Z7 XL 45 kN <sup>4)</sup>	579101 R	1.161,47	
	M 88,9 G XL (PR-3S)	Z6 XL <sup>3)</sup> / Z7 XL 45 kN <sup>4)</sup>	579110 R	1.355,58	
	M 108,0 G XL (PR-3S)	Z6 XL <sup>3)</sup> / Z7 XL 45 kN <sup>4)</sup>	579111 R	1.355,58	
	M 15 S (PR-2B)	Z8	574738 R	124,51	
	M 18 S (PR-2B)	Z8	574740 R	124,51	
	M 22 S (PR-2B)	Z8	574742 R	124,51	
	M 28 S (PR-2B)	Z8	574744 R	124,51	
	M 35 S (PR-2B)	Z8	574746 R	136,96	
	STELBI Polikraft	H 16*		570320	168,10
		H 20*		570350	168,10
		H 26*		570370	168,10
		TH 16*		570460	186,32
		TH 20*		570470	186,32
		TH 26*		570475	186,32
		TH 32		570480	186,32
TH 40			570485	246,99	
TH 50 (PZ-S)			572400	645,58	
TH 63 (PZ-S)			572405	645,58	
TH 16 S (PR-2B)**		Z8	574782 R	124,51	
TH 20 S (PR-2B)**		Z8	574788 R	124,51	
TH 26 S (PR-2B)**		Z8	574794 R	124,51	
TH 32 S (PR-2B)		Z8	574798 R	136,96	
U 16*			570765	174,33	
U 20*			570775	174,33	
U 26* <sup>12)</sup>			570750	204,43	
STELBI Stelgas		TH 16*		570460	186,32
	TH 20*		570470	186,32	
	TH 26*		570475	186,32	
	TH 16 S (PR-2B)**	Z8	574782 R	124,51	
	TH 20 S (PR-2B)**	Z8	574788 R	124,51	
	TH 26 S (PR-2B)**	Z8	574794 R	124,51	

System	Pressing tongs / pressing rings	Driven by adapter tongs	Art.-No.	€	
STH Westco COPPER PRESS	M 15		570110	154,61	
	M 22		570130	154,61	
	M 28 <sup>1)</sup>		570140	154,61	
	M 35		570150	154,61	
	M 42 (PR-3S)	Z2	572706 R	672,57	
	M 54 (PR-3S)	Z2	572708 R	672,57	
	M 15 S (PR-2B)	Z8	574738 R	124,51	
	M 22 S (PR-2B)	Z8	574742 R	124,51	
	M 28 S (PR-2B)	Z8	574744 R	124,51	
M 35 S (PR-2B)	Z8	574746 R	136,96		
<b>T</b>					
TDM BRASS Serie 1600	H 16*		570320	168,10	
	H 18*		570340	168,10	
	H 20*		570350	168,10	
	H 25*		570360	168,10	
	H 26*		570370	168,10	
	H 32		570380	168,10	
	TH 16*		570460	186,32	
	TH 18*		570465	186,32	
	TH 20*		570470	186,32	
	TH 25*		570495	186,32	
	TH 26*		570475	186,32	
	THL 32		570487	186,32	
	TH 40		570485	246,99	
	TH 50 (PZ-S)		572400	645,58	
	TH 63 (PZ-S)		572405	645,58	
	TH 16 S (PR-2B)**	Z8	574782 R	124,51	
TH 18 S (PR-2B)**	Z8	574786 R	124,51		
TH 20 S (PR-2B)**	Z8	574788 R	124,51		
TH 25 S (PR-2B)**	Z8	574792 R	124,51		
TH 26 S (PR-2B)**	Z8	574794 R	124,51		
U 16*		570765	174,33		
U 18*		570770	174,33		
U 20*		570775	174,33		
U 25*		570780	174,33		
U 26* <sup>12)</sup>		570750	204,43		
U 32		570785	204,43		
TDM BRASS Serie 2600	H 16*		570320	168,10	
	H 18*		570340	168,10	
	H 20*		570350	168,10	
	H 25*		570360	168,10	
	H 26*		570370	168,10	
	H 32		570380	168,10	
	TH 16*		570460	186,32	
	TH 18*		570465	186,32	
	TH 20*		570470	186,32	
	TH 25*		570495	186,32	
	TH 26*		570475	186,32	
	THL 32		570487	186,32	
	TH 16 S (PR-2B)**	Z8	574782 R	124,51	
	TH 18 S (PR-2B)**	Z8	574786 R	124,51	
	TH 20 S (PR-2B)**	Z8	574788 R	124,51	
	TH 25 S (PR-2B)**	Z8	574792 R	124,51	
TH 26 S (PR-2B)**	Z8	574794 R	124,51		
U 16*		570765	174,33		
U 18*		570770	174,33		
U 20*		570775	174,33		
U 25*		570780	174,33		
U 26* <sup>12)</sup>		570750	204,43		
U 32		570785	204,43		
TDM BRASS Serie 1700 gas	TH 16*		570460	186,32	
	TH 20*		570470	186,32	
	TH 26*		570475	186,32	
	THL 32		570487	186,32	
	TH 16 S (PR-2B)**	Z8	574782 R	124,51	
	TH 20 S (PR-2B)**	Z8	574788 R	124,51	
TH 26 S (PR-2B)**	Z8	574794 R	124,51		
TermoConcept TC-PRESS	Basic E01 <sup>5)</sup>		571855	305,17	
THERMOLUTZ	H 14*		570310	168,10	
	H 16*		570320	168,10	
	TH 20*		570470	186,32	
	TH 20 S (PR-2B)**	Z8	574788 R	124,51	
	TE-SA	TH 14*		570455	186,32
	TE-SA press serie 800	TH 16*		570460	186,32
		TH 18*		570465	186,32
TH 20*			570470	186,32	
TH 26*			570475	186,32	
TH 32			570480	186,32	
TH 40			570485	246,99	
TH 50 (PZ-S)			572400	645,58	
TH 63 (PZ-S)			572405	645,58	
TH 14 S (PR-2B)**		Z8	574778 R	124,51	
TH 16 S (PR-2B)**		Z8	574782 R	124,51	
TH 18 S (PR-2B)**		Z8	574786 R	124,51	
TH 20 S (PR-2B)**		Z8	574788 R	124,51	
TH 26 S (PR-2B)**	Z8	574794 R	124,51		
TH 32 S (PR-2B)	Z8	574798 R	136,96		
THERMACOME ACOPELX ALU	H 16*		570320	168,10	
	H 20*		570350	168,10	
	H 26*		570370	168,10	
	H 32		570380	168,10	
	TH 16*		570460	186,32	
	TH 20*		570470	186,32	
	TH 26*		570475	186,32	
	TH 32		570480	186,32	
	U 16*		570765	174,33	
	U 20*		570775	174,33	
	U 32		570785	204,43	





# REMS pressing tongs

# REMS pressing rings

Accessories for REMS radial presses (except for REMS Mini-Press)  
and suitable radial presses of other makes

System	Pressing tongs / pressing rings	Driven by adapter tongs	Art.-No.	€
<b>U</b>				
UNICAL AG MAX-MULTIPEX	U 16* U 20* H 26* U 26* <sup>(12)</sup> U 32		570765 570775 570370 570750 570785	174,33 174,33 168,10 204,43 204,43
UNIDELTA DELTAPRESS	TH 16* TH 20* TH 26* TH 32 TH 40 TH 50 (PZ-S) TH 63 (PZ-S) TH 16 S (PR-2B)** TH 20 S (PR-2B)** TH 26 S (PR-2B)** TH 32 S (PR-2B)		570460 570470 570475 570480 570485 572400 572405 574782 R 574788 R 574794 R 574798 R	186,32 186,32 186,32 246,99 645,58 645,58 124,51 124,51 124,51 136,96
	H 16* H 20* H 26* H 32 H 40 (PZ-4G) U 16* U 20* U 32 U 40 U 50 U 63 (PZ-S)		570320 570350 570370 570380 570390 570765 570775 570785 570790 570795 572365	168,10 168,10 168,10 168,10 565,67 174,33 174,33 204,43 249,07 298,89 645,58
UNIDELTA DELTAPRESS GAS	TH 16* TH 20* TH 26* TH 32 TH 16 S (PR-2B)** TH 20 S (PR-2B)** TH 26 S (PR-2B)** TH 32 S (PR-2B)		570460 570470 570475 570480 574782 R 574788 R 574794 R 574798 R	186,32 186,32 186,32 186,32 124,51 124,51 124,51 136,96
	H 16* H 20* H 26* H 32 U 16* U 20* U 32		570320 570350 570370 570380 570765 570775 570785	168,10 168,10 168,10 168,10 174,33 174,33 204,43
Uponor	UP 14* UP 16* UP 20* UP 25 UP 32 U 40 U 50 U 63 (PR-3B) U 63 (PZ-S) U 75 (PR-3B)		572630 572632 572636 572638 572640 570790 570795 572837 R 572365 572828 R	174,33 174,33 174,33 174,33 204,43 249,07 298,89 733,81 645,58 645,58
		Z4		
		Z4		
<b>V</b>				
Valsir Bravopress	B 16* B 20* B 26 B 32 F 16* F 20* F 26* F 16 S (PR-2B)** F 20 S (PR-2B)** F 26 S (PR-2B)** H 16* H 20* H 26* H 32 H 32 V TH 16* TH 20* TH 26* TH 32 U 16* U 20* U 26* <sup>(12)</sup> U 32		570850 570860 570870 570880 570717 570727 570730 574728 R 574730 R 574732 R 570320 570350 570370 570380 570685 570460 570470 570475 570480 570765 570775 570750 570785	203,40 203,40 224,16 224,16 177,45 177,45 191,98 124,51 124,51 124,51 168,10 168,10 168,10 214,81 186,32 186,32 186,32 186,32 174,33 174,33 204,43 204,43
		Z8		
		Z8		
		Z8		
Valsir PEXAL	H 14* H 16* H 20* H 26* H 32 H 32 V TH 16* TH 20* TH 26* TH 32 U 16* U 20* U 26* <sup>(12)</sup> U 32		570310 570320 570350 570370 570380 570685 570460 570470 570475 570480 570765 570775 570750 570785	168,10 168,10 168,10 168,10 168,10 214,81 186,32 186,32 186,32 186,32 174,33 174,33 204,43 204,43
		Z4		
		Z4		

System	Pressing tongs / pressing rings	Driven by adapter tongs	Art.-No.	€
Van Marcke NV SYSTEMPEX	TH 16* TH 20* TH 26* TH 32 TH 40 TH 50 (PZ-S) TH 63 (PZ-S) THz 75 (PR-3B) TH 16 S (PR-2B)** TH 20 S (PR-2B)** TH 26 S (PR-2B)** TH 32 S (PR-2B)		570460 570470 570475 570480 570485 572400 572405 572829 R 574782 R 574788 R 574794 R 574798 R	186,32 186,32 186,32 246,99 645,58 645,58 609,25 124,51 124,51 124,51 136,96
		Z4		
		Z8		
		Z8		
		Z8		
		Z8		
Van Marcke NV Tubipress	M 12 M 15 M 18 M 22 M 28 M 35 M 42 (PZ-4G) M 54 (PZ-4G) M 42 (PR-3S) M 54 (PR-3S) M 76.1 XL (PR-3S) M 88.9 G XL (PR-3S) M 108.0 G XL (PR-3S) M 12 S (PR-2B) M 15 S (PR-2B) M 18 S (PR-2B) M 22 S (PR-2B) M 28 S (PR-2B) M 35 S (PR-2B)		570100 570110 570120 570130 570140 570150 570160 570170 572706 R 572708 R 579101 R 579110 R 579111 R 574736 R 574738 R 574740 R 574742 R 574744 R 574746 R	154,61 154,61 154,61 154,61 154,61 154,61 498,19 498,19 672,57 672,57 1.161,47 1.355,58 1.355,58 124,51 124,51 124,51 124,51 124,51 136,96
Variotherm System TH	TH 11,6* TH 16* TH 20* TH 11,6 S (PR-2B)** TH 16 S (PR-2B)** TH 20 S (PR-2B)**		570482 570460 570470 574774 R 574782 R 574788 R	186,32 186,32 186,32 124,51 124,51 124,51
		Z8		
		Z8		
		Z8		
VESBO CARBON	M 15 M 18 M 22 M 28 M 35 M 42 (PR-3S) M 54 (PR-3S) M 76.1 XL (PR-3S) M 88.9 G XL (PR-3S) M 108.0 G XL (PR-3S) M 12 S (PR-2B) M 15 S (PR-2B) M 18 S (PR-2B) M 22 S (PR-2B) M 28 S (PR-2B) M 35 S (PR-2B)		570110 570120 570130 570140 570150 572706 R 572708 R 579101 R 579110 R 579111 R 574738 R 574740 R 574742 R 574744 R 574746 R	154,61 154,61 154,61 154,61 154,61 672,57 672,57 1.161,47 1.355,58 1.355,58 124,51 124,51 124,51 124,51 124,51 136,96
		Z2		
		Z2		
		Z2		
		Z2		
VESBO INOX	M 15 M 18 M 22 M 28 M 35 M 42 (PR-3S) M 54 (PR-3S) M 76.1 XL (PR-3S) M 88.9 G XL (PR-3S) M 108.0 G XL (PR-3S) M 12 S (PR-2B) M 15 S (PR-2B) M 18 S (PR-2B) M 22 S (PR-2B) M 28 S (PR-2B) M 35 S (PR-2B)		570110 570120 570130 570140 570150 572706 R 572708 R 579101 R 579110 R 579111 R 574738 R 574740 R 574742 R 574744 R 574746 R	154,61 154,61 154,61 154,61 154,61 672,57 672,57 1.161,47 1.355,58 1.355,58 124,51 124,51 124,51 124,51 136,96
		Z2		
		Z2		
		Z2		
VESBO MULTIPRESS TH-U	TH 16* TH 20* TH 26* TH 32 TH 16 S (PR-2B)** TH 20 S (PR-2B)** TH 26 S (PR-2B)** TH 32 S (PR-2B) U 16* U 20* U 26* <sup>(12)</sup> U 32		570460 570470 570475 570480 574782 R 574788 R 574794 R 574798 R 570765 570775 570750 570785	186,32 186,32 186,32 186,32 124,51 124,51 124,51 136,96 174,33 174,33 204,43 204,43
		Z8		
		Z8		
		Z8		
		Z8		
VESBO VPREMIUM	U 16* U 20* U 25* U 32 U 40 U 50 U 63 (PZ-S)		570765 570775 570780 570785 570790 570795 572365	174,33 174,33 174,33 204,43 249,07 298,89 645,58
Viega Fonterra	VX 12* VP 14/15* VP 16/17* VP 20* VP 25*		571630 570905 570910 570915 570920	214,81 185,75 185,75 185,75 185,75
Viega MegaPress (ASTM) <sup>(1)</sup>	VMP 3/8" (00 17,2 mm) VMP 1/2" G (00 21,3 mm) VMPz 3/8" (00 26,9 mm) VMPz 1" (00 33,7 mm) VMPz 1 1/4" (PZ-S) (00 42,4 mm) VMPz 1 1/2" (PR-3B) (00 48,3 mm) VMPz 2" (PR-3B) (00 60,3 mm)		571740 571766 R 571764 571767 57213 572844 R 572845 R	214,81 214,81 214,81 214,81 704,75 479,50 479,50
		Z5		
		Z5		

# REMS pressing tongs REMS pressing rings

Accessories for REMS radial presses (except for REMS Mini-Press) and suitable radial presses of other makes

System	Pressing tongs / pressing rings	Driven by adapter tongs	Art.-No.	€
Viega MegaPress 304 FKM (ASTM) <sup>10)</sup>	VMP ½" G (OD 21,3 mm)		571766 R	214,81
	VMPz ¾" (OD 26,9 mm)		571764	214,81
	VMPz 1" (OD 33,7 mm)		571767	214,81
	VMPz 1¼" (PZ-S) (OD 42,4 mm)		572413	704,75
	VMPz 1½" (PR-3B) (OD 48,3 mm)	25	572844 R	479,50
	VMPz 2" (PR-3B) (OD 60,3 mm)	25	572845 R	479,50
Viega MegaPress 316 (ASTM) <sup>10)</sup>	VMP ½" G (OD 21,3 mm)		571766 R	214,81
	VMPz ¾" (OD 26,9 mm)		571764	214,81
	VMPz 1" (OD 33,7 mm)		571767	214,81
	VMPz 1¼" (PZ-S) (OD 42,4 mm)		572413	704,75
	VMPz 1½" (PR-3B) (OD 48,3 mm)	25	572844 R	479,50
	VMPz 2" (PR-3B) (OD 60,3 mm)	25	572845 R	479,50
Viega MegaPress 316 FKM (ASTM) <sup>10)</sup>	VMP ½" G (OD 21,3 mm)		571766 R	214,81
	VMPz ¾" (OD 26,9 mm)		571764	214,81
	VMPz 1" (OD 33,7 mm)		571767	214,81
	VMPz 1¼" (PZ-S) (OD 42,4 mm)		572413	704,75
	VMPz 1½" (PR-3B) (OD 48,3 mm)	25	572844 R	479,50
	VMPz 2" (PR-3B) (OD 60,3 mm)	25	572845 R	479,50
Viega MegaPress CuNi (ASTM) <sup>10)</sup>	VMP ½" G (OD 21,3 mm)		571766 R	214,81
	VMPz ¾" (OD 26,9 mm)		571764	214,81
	VMPz 1" (OD 33,7 mm)		571767	214,81
	VMPz 1¼" (PZ-S) (OD 42,4 mm)		572413	704,75
	VMPz 1½" (PR-3B) (OD 48,3 mm)	25	572844 R	479,50
	VMPz 2" (PR-3B) (OD 60,3 mm)	25	572845 R	479,50
Viega MegaPress FKM (ASTM) <sup>10)</sup>	VMP ½" G (OD 21,3 mm)		571766 R	214,81
	VMPz ¾" (OD 26,9 mm)		571764	214,81
	VMPz 1" (OD 33,7 mm)		571767	214,81
	VMPz 1¼" (PZ-S) (OD 42,4 mm)		572413	704,75
	VMPz 1½" (PR-3B) (OD 48,3 mm)	25	572844 R	479,50
	VMPz 2" (PR-3B) (OD 60,3 mm)	25	572845 R	479,50
Viega Megapress (EN) <sup>9)</sup>	VMP ¾" (OD 17,2 mm)		571740	214,81
	VMP ½" G (OD 21,3 mm)		571766 R	214,81
	VMPz ¾" (OD 26,9 mm)		571764	214,81
	VMPz 1" (OD 33,7 mm)		571767	214,81
	VMPz 1¼" (PZ-S) (OD 42,4 mm)		572413	704,75
	VMPz 1½" (PR-3B) (OD 48,3 mm)	25	572844 R	479,50
VMPz 2" (PR-3B) (OD 60,3 mm)	25	572845 R	479,50	
Viega Megapress S (EN) <sup>9)</sup>	VMP ¾" (OD 17,2 mm)		571740	214,81
	VMP ½" G (OD 21,3 mm)		571766 R	214,81
	VMPz ¾" (OD 26,9 mm)		571764	214,81
	VMPz 1" (OD 33,7 mm)		571767	214,81
	VMPz 1¼" (PZ-S) (OD 42,4 mm)		572413	704,75
	VMPz 1½" (PR-3B) (OD 48,3 mm)	25	572844 R	479,50
VMPz 2" (PR-3B) (OD 60,3 mm)	25	572845 R	479,50	
Viega Megapress S XL (EN) <sup>9)</sup>	VMPz 2½" XL (PR-3B) EN (OD 76,1 mm)		27 XL 45 kN <sup>4)</sup>	609,25
	VMPz 3" XL (PR-3B) (OD 88,9 mm)		27 XL 45 kN <sup>4)</sup>	609,25
	VMPz 4" XL (PR-3B) (OD 114,3 mm)		27 XL 45 kN <sup>4)</sup>	645,58
Viega Pexfit	VX 16*		571635	214,81
	VX 20*		571640	214,81
	VX 25*		571645	214,81
Viega Pexfit G	VX 16*		571635	214,81
	VX 20*		571640	214,81
	VX 25*		571645	214,81
Viega Prestabo	V 12		570107	154,61
	V 15		570115	154,61
	V 18		570125	154,61
	V 22		570135	154,61
	V 28		570145	154,61
	V 35		570155	154,61
	V 42		570165	360,13
	V 42 (PR-2B)	22	572850 R	322,77
	V 54		570175	370,51
	V 54 (PR-2B)	22	572851 R	348,72
	Vfz 64,0 (PR-3B) <sup>6)</sup>	25	572815 R	609,25
	Vfz 76,1 (PR-3B) <sup>6)</sup>	25	572816 R	609,25
	Vfz 88,9 (PR-3B) <sup>6)</sup>	25	572817 R	645,58
	Vfz 108,0 (PR-3B) <sup>6)</sup>	25	572818 R	645,58
	V 12 S (PR-2B)	28	574748 R	124,51
	V 15 S (PR-2B)	28	574752 R	124,51
	V 18 S (PR-2B)	28	574756 R	124,51
	V 22 S (PR-2B)	28	574758 R	124,51
	V 28 S (PR-2B)	28	574760 R	124,51
	V 35 S (PR-2B)	28	574762 R	136,96

System	Pressing tongs / pressing rings	Driven by adapter tongs	Art.-No.	€
Viega Profipress	V 12		570107	154,61
	VG 14		570132	154,61
	V 15		570115	154,61
	VG 16		570137	154,61
	V 18		570125	154,61
	V 22		570135	154,61
	V 28		570145	154,61
	V 35		570155	154,61
	V 42		570165	360,13
	V 42 (PR-2B)	22	572850 R	322,77
	V 54 (PR-2B)	22	572851 R	348,72
	Vfz 64,0 (PR-3B) <sup>6)</sup>	25	572846 R	609,25
	Vfz 66,7 (PR-3B)	25	572846 R	609,25
	Vfz 76,1 (PR-3B) <sup>6)</sup>	25	572816 R	609,25
	Vfz 88,9 (PR-3B) <sup>6)</sup>	25	572817 R	645,58
	Vfz 108,0 (PR-3B) <sup>6)</sup>	25	572818 R	645,58
	V 12 S (PR-2B)	28	574748 R	124,51
	VG 14 S (PR-2B)	28	574750 R	124,51
	V 15 S (PR-2B)	28	574752 R	124,51
	VG 16 S (PR-2B)	28	574754 R	124,51
V 18 S (PR-2B)	28	574756 R	124,51	
V 22 S (PR-2B)	28	574758 R	124,51	
V 28 S (PR-2B)	28	574760 R	124,51	
V 35 S (PR-2B)	28	574762 R	136,96	
Viega Profipress G	V 12		570107	154,61
	VG 14		570132	154,61
	V 15		570115	154,61
	VG 16		570137	154,61
	V 18		570125	154,61
	V 22		570135	154,61
	V 28		570145	154,61
	V 35		570155	154,61
	V 42		570165	360,13
	V 42 (PR-2B)	22	572850 R	322,77
	V 54 (PR-2B)	22	572851 R	348,72
	Vfz 64,0 (PR-3B) <sup>6)</sup>	25	572815 R	609,25
	V 12 S (PR-2B)	28	574748 R	124,51
	V 15 S (PR-2B)	28	574752 R	124,51
V 18 S (PR-2B)	28	574756 R	124,51	
V 22 S (PR-2B)	28	574758 R	124,51	
V 28 S (PR-2B)	28	574760 R	124,51	
V 35 S (PR-2B)	28	574762 R	136,96	
Viega Profipress S	V 12		570107	154,61
	V 15		570115	154,61
	V 18		570125	154,61
	V 22		570135	154,61
	V 28		570145	154,61
	V 35		570155	154,61
	V 42		570165	360,13
	V 12 S (PR-2B)	28	574748 R	124,51
	V 15 S (PR-2B)	28	574752 R	124,51
	V 18 S (PR-2B)	28	574756 R	124,51
	V 22 S (PR-2B)	28	574758 R	124,51
	V 28 S (PR-2B)	28	574760 R	124,51
	V 35 S (PR-2B)	28	574762 R	136,96
	Viega Profipress Therm	V 12		570107
V 15			570115	154,61
V 18			570125	154,61
V 22			570135	154,61
V 12 S (PR-2B)		28	574748 R	124,51
V 15 S (PR-2B)		28	574752 R	124,51
V 18 S (PR-2B)	28	574756 R	124,51	
V 22 S (PR-2B)	28	574758 R	124,51	
Viega ProPress (ASTM) <sup>10)</sup>	VUS ½" (OD 15,9 mm)		571770	186,79
	VUS ¾" (OD 22,2 mm)		571775	186,79
	VUS 1" (OD 28,6 mm)		571780	186,79
	VUS 1¼" (OD 34,9 mm)		571785	186,79
	VUS 1½" (OD 41,3 mm)		571790	360,13
	VUS 2" (OD 54,0 mm)		571795	370,51
XL-C/XL-S	VUSFz 2½" (PR-3B) (OD 66,7 mm)	25	572819 R	609,25
XL-C/XL-S	VUSFz 3" (PR-3B) (OD 79,4 mm)	25	572820 R	609,25
XL-C/XL-S	VUSFz 4" (PR-3B) (OD 104,8 mm)	25	572821 R	645,58

Pressfitting systems for gas installations must only be pressed with pressing tongs/pressing rings which are highlighted in yellow.

Observe the national regulations. Read and observe the instructions for use and the installation instructions of the system provider/manufacturer.

\* Can also be driven by the REMS Eco-Press manual radial press, see page 185. Observe the national regulations.

\*\* Can also be driven by the REMS Eco-Press manual radial press using the Z8 adapter tongs, see page 185. Observe the national regulations.

<sup>1)</sup> Only pressing tongs from designation "108" (1<sup>st</sup> quarter of 2008), "208" (2<sup>nd</sup> quarter of 2008) etc. can be used. The designation is stamped on every pressing jaw.

<sup>2)</sup> For this pressfitting system producing a pressing joint with manual radial presses is not permitted.

<sup>3)</sup> Driven by REMS Power-Press XL ACC, see page 188.

<sup>4)</sup> Driven by REMS Akku-Press XL 45 kN 22V ACC, see page 196.

<sup>5)</sup> For taking suitable pressing inserts.

<sup>6)</sup> Press fittings made of red bronze (Sanpress XL) must be pressed with pressing rings with press contour VR, copper fittings (Profipress XL, Profipress G XL), carbon steel (Prestabo XL) and stainless steel fittings (Sanpress Inox XL, Sanpress Inox G XL) with pressing rings with press contour VF.

<sup>7)</sup> Use pressing rings labelled "M 88.9 G" or "M 108 G" on the three pressing segments for gas installations.

<sup>8)</sup> For making press joints for operating pressure ≤ PN 10.

<sup>9)</sup> For pipes of the EN technical standard. Observe the instructions for use of the system provider/manufacturer.

<sup>10)</sup> For pipes of the ASTM technical standard. Observe the instructions for use of the system provider/manufacturer.

<sup>11)</sup> Only use pressing tongs identified by "VMP ½" G" on the pressing jaws for gas installations.

<sup>12)</sup> Previous designation: C 26 pressing tongs

The suitability of REMS pressing tools for pressfitting systems: Date 27.10.2023. For the updated situation regarding suitability status check our website: [www.rems.de](http://www.rems.de) > Downloads > Product catalogues, brochures > REMS Catalogue.

See page 238 for adapter tongs. Pressing tongs/pressing rings for additional pressfitting systems on request.

# REMS pressing tongs

## REMS pressing rings

Accessories for REMS radial presses (except for REMS Mini-Press) and suitable radial presses of other makes

System	Pressing tongs / pressing rings	Driven by adapter tongs	Art.-No.	€
Viega ProPress 304 FKM (ASTM) <sup>(3)</sup>	VUS ½" (OD 15,9 mm)		571770	186,79
	VUS ¾" (OD 22,2 mm)		571775	186,79
	VUS 1" (OD 28,6 mm)		571780	186,79
	VUS 1 ½" (OD 34,9 mm)		571785	186,79
	VUS 1 ½" (OD 41,3 mm)		571790	360,13
	VUS 2" (OD 54,0 mm)		571795	370,51
				572819 R
XL-C/XL-S	VUSFz 2 ½" (PR-3B) (OD 66,7 mm)	Z5	572820 R	609,25
XL-C/XL-S	VUSFz 3" (PR-3B) (OD 79,4 mm)	Z5	572821 R	645,58
Viega ProPress 316 (ASTM) <sup>(3)</sup>	VUS ½" (OD 15,9 mm)		571770	186,79
	VUS ¾" (OD 22,2 mm)		571775	186,79
	VUS 1" (OD 28,6 mm)		571780	186,79
	VUS 1 ½" (OD 34,9 mm)		571785	186,79
	VUS 1 ½" (OD 41,3 mm)		571790	360,13
	VUS 2" (OD 54,0 mm)		571795	370,51
			572819 R	609,25
XL-C/XL-S	VUSFz 2 ½" (PR-3B) (OD 66,7 mm)	Z5	572820 R	609,25
XL-C/XL-S	VUSFz 3" (PR-3B) (OD 79,4 mm)	Z5	572821 R	645,58
Viega ProPress WATER System AUS	VAU 15 (OD 12,7 mm)		572687	159,80
	VAU 20 (OD 19,1 mm)		572689	159,80
	VAU 25 (OD 25,4 mm)		572691	159,80
	VAU 32 (OD 31,8 mm)		572693	168,10
	VAU 40 (OD 38,1 mm)		572695	249,07
	VAU 50 (OD 50,8 mm)		572697	441,10
Viega ProPressG GAS System AUS	VAU 15 (OD 12,7 mm)		572687	159,80
	VAU 20 (OD 19,1 mm)		572689	159,80
	VAU 25 (OD 25,4 mm)		572691	159,80
	VAU 32 (OD 31,8 mm)		572693	168,10
	VAU 40 (OD 38,1 mm)		572695	249,07
	VAU 50 (OD 50,8 mm)		572697	441,10
Viega Raxinox	VRX 16		571750	196,13
	VRX 20		571752	196,13
Viega Raxofix	VRX 16		571750	196,13
	VRX 20		571752	196,13
	VRX 25		571754	214,81
	VRX 32		571756	214,81
	VRX 40		571758	298,89
	VRX 50		571760	348,72
	VRX 63		571797	560,47
Viega Sanfix <sup>(2)</sup>	VP 16/17 <sup>(3)</sup>		570910	185,75
	VP 20 <sup>(3)</sup>		570915	185,75
	VP 25 <sup>(3)</sup>		570920	185,75
	VP 32		570925	205,47
	VP 40 (PZ-4G)		570970	493,00
	VPz 50 (PZ-S)		572350	645,58
	VPz 63 (PZ-S)		572355	645,58
Viega Sanfix Fosta <sup>(3)</sup>	VP 16/17 <sup>(3)</sup>		570910	185,75
	VP 20 <sup>(3)</sup>		570915	185,75
	VP 25 <sup>(3)</sup>		570920	185,75
	VP 32		570925	205,47
	VP 40 (PZ-4G)		570970	493,00
	VPz 50 (PZ-S)		572350	645,58
	VPz 63 (PZ-S)		572355	645,58
Viega Sanpress	V 12		570107	154,61
	V 15		570115	154,61
	V 18		570125	154,61
	V 22		570135	154,61
	V 28		570145	154,61
	V 35		570155	154,61
	V 42		570165	360,13
	V 42 (PR-2B)	Z2	572850 R	322,77
	V 54		570175	370,51
	V 54 (PR-2B)	Z2	572851 R	348,72
	VR 76,1 (PR-3B) <sup>(4)</sup>	Z5	572822 R	609,25
	VR 88,9 (PR-3B) <sup>(4)</sup>	Z5	572823 R	645,58
	VR 108,0 (PR-3B) <sup>(4)</sup>	Z5	572824 R	645,58
	V 12 S (PR-2B)	Z8	574748 R	124,51
	V 15 S (PR-2B)	Z8	574752 R	124,51
	V 18 S (PR-2B)	Z8	574756 R	124,51
	V 22 S (PR-2B)	Z8	574758 R	124,51
	V 28 S (PR-2B)	Z8	574760 R	124,51
	V 35 S (PR-2B)	Z8	574762 R	136,96
Viega Sanpress Inox	V 15		570115	154,61
	V 18		570125	154,61
	V 22		570135	154,61
	V 28		570145	154,61
	V 35		570155	154,61
	V 42		570165	360,13
	V 42 (PR-2B)	Z2	572850 R	322,77
	V 54		570175	370,51
	V 54 (PR-2B)	Z2	572851 R	348,72
	Vfz 64,0 (PR-3B) <sup>(4)</sup>	Z5	572815 R	609,25
	Vfz 76,1 (PR-3B) <sup>(4)</sup>	Z5	572816 R	609,25
	Vfz 88,9 (PR-3B) <sup>(4)</sup>	Z5	572817 R	645,58
	Vfz 108,0 (PR-3B) <sup>(4)</sup>	Z5	572818 R	645,58
	V 15 S (PR-2B)	Z8	574752 R	124,51
	V 18 S (PR-2B)	Z8	574756 R	124,51
	V 22 S (PR-2B)	Z8	574758 R	124,51
	V 28 S (PR-2B)	Z8	574760 R	124,51
	V 35 S (PR-2B)	Z8	574762 R	136,96
Viega Sanpress Inox G	V 15		570115	154,61
	V 18		570125	154,61
	V 22		570135	154,61
	V 28		570145	154,61
	V 35		570155	154,61
	V 42		570165	360,13
	V 42 (PR-2B)	Z2	572850 R	322,77
	V 54		570175	370,51
	V 54 (PR-2B)	Z2	572851 R	348,72
	Vfz 64,0 (PR-3B) <sup>(4)</sup>	Z5	572815 R	609,25
	Vfz 76,1 (PR-3B) <sup>(4)</sup>	Z5	572816 R	609,25
	Vfz 88,9 (PR-3B) <sup>(4)</sup>	Z5	572817 R	645,58
	Vfz 108,0 (PR-3B) <sup>(4)</sup>	Z5	572818 R	645,58
	V 15 S (PR-2B)	Z8	574752 R	124,51
	V 18 S (PR-2B)	Z8	574756 R	124,51
	V 22 S (PR-2B)	Z8	574758 R	124,51
	V 28 S (PR-2B)	Z8	574760 R	124,51
	V 35 S (PR-2B)	Z8	574762 R	136,96

System	Pressing tongs / pressing rings	Driven by adapter tongs	Art.-No.	€
Viega Smartpress	VX 16"		571635	214,81
	VX 20"		571640	214,81
	VX 25"		571645	214,81
Viega Temponox	V 15		570115	154,61
	V 18		570125	154,61
	V 22		570135	154,61
	V 28		570145	154,61
	V 35		570155	154,61
	V 42		570165	360,13
	V 42 (PR-2B)	Z2	572850 R	322,77
	V 54		570175	370,51
	V 54 (PR-2B)	Z2	572851 R	348,72
	Vfz 76,1 (PR-3B) <sup>(4)</sup>	Z5	572816 R	609,25
	Vfz 88,9 (PR-3B) <sup>(4)</sup>	Z5	572817 R	645,58
	Vfz 108,0 (PR-3B) <sup>(4)</sup>	Z5	572818 R	645,58
	V 15 S (PR-2B)	Z8	574752 R	124,51
	V 18 S (PR-2B)	Z8	574756 R	124,51
V 22 S (PR-2B)	Z8	574758 R	124,51	
V 28 S (PR-2B)	Z8	574760 R	124,51	
V 35 S (PR-2B)	Z8	574762 R	136,96	
Viessmann	TH 14"		570455	186,32
	TH 16"		570460	186,32
	TH 20"		570470	186,32
	TH 26"		570475	186,32
	TH 32		570480	186,32
	TH 40		570485	246,99
	TH 16"		570460	186,32
Vogel & Noot EASYTEC	TH 20"		570470	186,32
	TH 26"		570475	186,32
	TH 32		570480	186,32
	TH 40		570485	246,99
	TH 50 (PZ-S)		572400	645,58
	TH 63 (PZ-S)		572405	645,58
	TH 16 S (PR-2B)**	Z8	574782 R	124,51
	TH 20 S (PR-2B)**	Z8	574788 R	124,51
	TH 26 S (PR-2B)**	Z8	574794 R	124,51
	TH 32 S (PR-2B)	Z8	574798 R	136,96
VSH	> Aalberts integrated piping systems			
<b>W</b>				
Watts MTR Art press	TH 16"		570460	186,32
	TH 20"		570470	186,32
	TH 26"		570475	186,32
	TH 32		570480	186,32
WATTS Radiant	US ¾"		571450	211,70
	US ½"		571455	211,70
	US ¾"		571460	211,70
	US 1"		571465	211,70
	US 1 ½"		571470	211,70
Watts WaterPEX RadiantPEX	US 1"		571475	211,70
	US 1 ½"		571475	211,70
	US ¾"		571450	211,70
	US ½"		571455	211,70
	US ¾"		571460	211,70
Watts RadiantPEX-AL	US 1"		571465	211,70
	US 1 ½"		571470	211,70
	US 1 ½"		571475	211,70
	U 16 (½")		570765	174,33
Watts RadiantPEX-AL	U 20 (¾")		570775	174,33
	U 25 (¾")		570780	174,33
	U 32 (1")		570785	204,43
Wavin Tigris K1/M1	U 50		570795	298,89
Wavin Tigris K5/M5	U 63 (PR-3B)	Z4	572837 R	733,81
	U 63 (PZ-S)		572365	645,58
	U 75 (PR-3B)	Z4	572828 R	645,58
Watts RadiantPEX-AL	B 16"		570850	203,40
	B 20"		570860	203,40
	B 32		570880	224,16
	H 16"		570320	168,10
	H 20"		570350	168,10
	H 25"		570360	168,10
	H 32		570380	168,10
	H 40 (PZ-4G)		570390	565,67
	TH 16"		570460	186,32
	TH 20"		570470	186,32
	TH 25"		570495	186,32
	TH 32		570480	186,32
	TH 40		570485	246,99
	TH 16 S (PR-2B)**	Z8	574782 R	124,51
	TH 20 S (PR-2B)**	Z8	574788 R	124,51
	TH 25 S (PR-2B)**	Z8	574792 R	124,51
	TH 32 S (PR-2B)	Z8	574798 R	136,96
	U 16"		570765	174,33
	U 20"		570775	174,33
	U 25"		570780	174,33
U 32		570785	204,43	
U 40		570790	249,07	
UP 16"		572632	174,33	
UP 20"		572636	174,33	
UP 25		572638	174,33	
UP 32		572640	204,43	

**REMS pressing tongs**  
**REMS pressing rings**

Accessories for REMS radial presses (except for REMS Mini-Press) and suitable radial presses of other makes

System	Pressing tongs/ pressing rings	Driven by adapter tongs	Art.-No.	€
WEECON	M 15		570110	154,61
PRESS-C-Stahl	M 18		570120	154,61
	M 22		570130	154,61
	M 28		570140	154,61
	M 35		570150	154,61
	M 42 (PZ-4G)		570160	498,19
	M 54 (PZ-4G)		570170	498,19
	M 42 (PR-3S)	Z2	572706 R	672,57
	M 54 (PR-3S)	Z2	572708 R	672,57
	M 76,1 XL (PR-3S)	Z6 XL <sup>2)</sup> / Z7 XL 45 kN <sup>4)</sup>	579101 R	1.161,47
	M 88,9 G XL (PR-3S)	Z6 XL <sup>3)</sup> / Z7 XL 45 kN <sup>4)</sup>	579110 R	1.355,58
	M 108,0 G XL (PR-3S)	Z6 XL <sup>3)</sup> / Z7 XL 45 kN <sup>4)</sup>	579111 R	1.355,58
	M 15 S (PR-2B)	Z8	574738 R	124,51
	M 18 S (PR-2B)	Z8	574740 R	124,51
	M 22 S (PR-2B)	Z8	574742 R	124,51
	M 28 S (PR-2B)	Z8	574744 R	124,51
	M 35 S (PR-2B)	Z8	574746 R	136,96
WEECON	M 15		570110	154,61
PRESS-Edelstahl	M 18		570120	154,61
	M 22		570130	154,61
	M 28		570140	154,61
	M 35		570150	154,61
	M 42 (PZ-4G)		570160	498,19
	M 54 (PZ-4G)		570170	498,19
	M 42 (PR-3S)	Z2	572706 R	672,57
	M 54 (PR-3S)	Z2	572708 R	672,57
	M 76,1 XL (PR-3S)	Z6 XL <sup>2)</sup> / Z7 XL 45 kN <sup>4)</sup>	579101 R	1.161,47
	M 88,9 G XL (PR-3S)	Z6 XL <sup>3)</sup> / Z7 XL 45 kN <sup>4)</sup>	579110 R	1.355,58
	M 108,0 G XL (PR-3S)	Z6 XL <sup>3)</sup> / Z7 XL 45 kN <sup>4)</sup>	579111 R	1.355,58
	M 15 S (PR-2B)	Z8	574738 R	124,51
	M 18 S (PR-2B)	Z8	574740 R	124,51
	M 22 S (PR-2B)	Z8	574742 R	124,51
	M 28 S (PR-2B)	Z8	574744 R	124,51
	M 35 S (PR-2B)	Z8	574746 R	136,96
WEECON	V 15		570115	154,61
PRESSS-Kupfer	V 18		570125	154,61
	V 22		570135	154,61
	V 28		570145	154,61
	V 35		570155	154,61
	V 42		570165	360,13
	V 42 (PR-2B)	Z2	572850 R	322,77
	V 54		570175	370,51
	V 54 (PR-2B)	Z2	572851 R	348,72
	V 15 S (PR-2B)	Z8	574752 R	124,51
	V 18 S (PR-2B)	Z8	574756 R	124,51
	V 22 S (PR-2B)	Z8	574758 R	124,51
	V 28 S (PR-2B)	Z8	574760 R	124,51
	V 35 S (PR-2B)	Z8	574762 R	136,96
WEM	U 16*		570765	174,33
WIELAND-WERKE	TH 14 <sup>2)</sup>		570455	186,32
cuprotherm CTX <sup>2)</sup>	TH 16 <sup>2)</sup>		570460	186,32
WKS-Press	TH 14*		570455	186,32
	TH 16*		570460	186,32
	TH 17*		570462	186,32
	TH 20*		570470	186,32
	TH 26*		570475	186,32
	TH 32		570480	186,32
	TH 40		570485	246,99
WÜRTH	TH 16*		570460	186,32
Würth	TH 20*		570470	186,32
	TH 26*		570475	186,32
	HE 32		571900	223,12
	HEz 40		571904	323,80

System	Pressing tongs/ pressing rings	Driven by adapter tongs	Art.-No.	€
<b>X</b>				
XtraConnect	F 16*		570717	177,45
	F 20*		570727	177,45
	F 26*		570730	191,98
	F 32		570735	191,98
	F 16 S (PR-2B)**	Z8	574728 R	124,51
	F 20 S (PR-2B)**	Z8	574730 R	124,51
	F 26 S (PR-2B)**	Z8	574732 R	124,51
	F 32 S (PR-2B)	Z8	574734 R	136,96
	H 16*		570320	168,10
	H 20*		570350	168,10
	H 26*		570370	168,10
	H 32		570380	168,10
	TH 16*		570460	186,32
	TH 20*		570470	186,32
	TH 26*		570475	186,32
	TH 32		570480	186,32
	TH 16 S (PR-2B)**	Z8	574782 R	124,51
	TH 20 S (PR-2B)**	Z8	574788 R	124,51
	TH 26 S (PR-2B)**	Z8	574794 R	124,51
	TH 32 S (PR-2B)	Z8	574798 R	136,96
	U 16*		570765	174,33
	U 20*		570775	174,33
(DN 26)	U 25*		570780	174,33
	U 32		570785	204,43
	VP 16*		570910	185,75
	VP 20*		570915	185,75
	VP 32		570925	205,47
<b>Z</b>				
ZEWOTHERM	TH 12*		570452	186,32
Zewo Press Premium	TH 16*		570460	186,32
	TH 17*		570462	186,32
	TH 18*		570465	186,32
	TH 20*		570470	186,32
	TH 26*		570475	186,32
	TH 32		570480	186,32
	TH 40		570485	246,99
	TH 50 (PZ-S)		572400	645,58
	TH 63 (PZ-S)		572405	645,58
	TH 12 S (PR-2B)**	Z8	574776 R	124,51
	TH 16 S (PR-2B)**	Z8	574782 R	124,51
	TH 17 S (PR-2B)**	Z8	574784 R	124,51
	TH 18 S (PR-2B)**	Z8	574786 R	124,51
	TH 20 S (PR-2B)**	Z8	574788 R	124,51
	TH 26 S (PR-2B)**	Z8	574794 R	124,51
	TH 32 S (PR-2B)	Z8	574798 R	136,96
ZEWOTHERM	TH 16*		570460	186,32
Zewo Press PPSU	TH 20*		570470	186,32
	TH 26*		570475	186,32
	TH 32		570480	186,32
	TH 16 S (PR-2B)**	Z8	574782 R	124,51
	TH 20 S (PR-2B)**	Z8	574788 R	124,51
	TH 26 S (PR-2B)**	Z8	574794 R	124,51
	TH 32 S (PR-2B)	Z8	574798 R	136,96
ZURN	US ¾**		571450	211,70
INDUSTRIES	US ½**		571455	211,70
ZURN PEX	US ¾**		571460	211,70
	US 1**		571465	211,70
	US 1 ¼**		571470	211,70
	US 1 ½**		571475	211,70
	US 2*		571477	285,40

Pressfitting systems for gas installations must only be pressed with pressing tongs/pressing rings which are highlighted in yellow.

Observe the national regulations. Read and observe the instructions for use and the installation instructions of the system provider/manufacturer.

\* Can also be driven by the REMS Eco-Press manual radial press, see page 185. Observe the national regulations.

\*\* Can also be driven by the REMS Eco-Press manual radial press using the Z8 adapter tongs, see page 185. Observe the national regulations.

<sup>1)</sup> Only pressing tongs from designation "108" (1<sup>st</sup> quarter of 2008), "208" (2<sup>nd</sup> quarter of 2008) etc. can be used. The designation is stamped on every pressing jaw.

<sup>2)</sup> For this pressfitting system producing a pressing joint with manual radial presses is not permitted.

<sup>3)</sup> Driven by REMS Power-Press XL ACC, see page 188.

<sup>4)</sup> Driven by REMS Akku-Press XL 45 kN 22V ACC, see page 196.

<sup>5)</sup> For taking suitable pressing inserts.

<sup>6)</sup> Press fittings made of red bronze (Sanpress XL) must be pressed with pressing rings with press contour VR, copper fittings (Profipress XL, Profipress G XL), carbon steel (Prestabo XL) and stainless steel fittings (Sanpress Inox XL, Sanpress Inox G XL) with pressing rings with press contour VF.

<sup>7)</sup> Use pressing rings labelled "M 88.9 G" or "M 108 G" on the three pressing segments for gas installations.

<sup>8)</sup> For making press joints for operating pressure ≤ PN 10.

<sup>9)</sup> For pipes of the EN technical standard. Observe the instructions for use of the system provider/manufacturer.

<sup>10)</sup> For pipes of the ASTM technical standard. Observe the instructions for use of the system provider/manufacturer.

<sup>11)</sup> Only use pressing tongs identified by "VMP ½" G" on the pressing jaws for gas installations.

<sup>12)</sup> Previous designation: C 26 pressing tongs

The suitability of REMS pressing tools for pressfitting systems: Date 27.10.2023. For the updated situation regarding suitability status check our website:

[www.rems.de](http://www.rems.de) > Downloads > Product catalogues, brochures > REMS Catalogue.

See page 238 for adapter tongs. Pressing tongs/pressing rings for additional pressfitting systems on request.

# Accessories

For REMS radial presses (except for REMS Mini-Press) and suitable radial presses of other makes

Description	Art.-No.	€
<b>Adapter tongs Z8</b> for driving REMS pressing rings S (PR-2B)	574702R	<b>144,28</b>
<b>Adapter tongs Z2</b> for driving REMS pressing rings M 35–54 (PR-3S), V 42–54 (PR-2B), RN 40–50 (PR-3S)	572795R	<b>144,28</b>
<b>Adapter tongs Z4</b> for driving REMS pressing rings F 75 (PR-3B), TH 63–75 (PR-3B), U 63–75 (PR-3B), RN 63 (PR-3B)	572801RX	<b>310,36</b>
<b>Adapter tongs Z5</b> for driving REMS pressing rings VFz/VR 64–108 (PR-3B), VMPz 1½–2" (PR-3B), VUSFz 2½–4" (PR-3B), VAUFz 65–100 (PR-3B)	572802RX	<b>310,36</b>
<b>Adapter tongs Z6 XL</b> for driving REMS pressing rings 64.0–108.0 XL (PR-3S), 2½–4" XL (PR-3S) with REMS Power-Press XL ACC	579120R	<b>373,68</b>
<b>Adapter tongs Z7 XL 45 kN</b> for driving REMS pressing rings 64.0–108.0 XL (PR-3S), 2½–4" XL (PR-3S), 2½–4" XL (PR-3B) with REMS Akku-Press XL 45 kN 22V ACC	579123R	<b>394,44</b>
<b>Steel case with insert for 6 pressing tongs</b> (up to Ø 35 mm/1" and pressing tongs U 40, U 50, TH 40, F 40, F 50, G 40, VUS 1½")/cropping tongs and compartment for pipe cutter up to 42 mm	570295R	<b>96,53</b>
<b>Steel case with insert for 2 pressing tongs</b> (M 42 (PZ-4G), M 54 (PZ-4G), V 42, V 54, H 40 A, VUS 1½", VUS 2")	570290R	<b>96,53</b>
<b>Steel case with insert for adapter tongs Z2 and pressing rings M 42 (PR-3S) and M 54 (PR-3S) or pressing rings SA 42 (PR-3S) and SA 54 (PR-3S).</b>	572810R	<b>96,53</b>
<b>Steel case with insert for adapter tongs Z5 and 4 pressing rings VFz 64.0–108.0/VR 76.1–108.0/VUSFz 2½–4" (PR-3B) or for adapter tongs Z5 and 1 pressing tong VMPz 1½ (PZ-S) and 2 pressing rings VMPz 1½–2" (PR-3B)</b>	572809R	<b>110,03</b>
<b>Steel case with insert for adapter tongs Mini Z8 and adapter tongs Z8 as well as 6 REMS pressing rings S (PR-2B)</b>	574516R	<b>96,53</b>
<b>L-Boxx system case with inlay for Mini Z8 adapter tongs and Z8 adapter tongs as well as 14 REMS S pressing rings (PR-2B)</b>	574704R	<b>146,36</b>
<b>L-Boxx system case with inserts for 8 pressing tongs (2B) and 6 pressing rings S (PR-2B)</b>	571136R	<b>146,36</b>
<b>L-Boxx system case with inserts for 3 different pressing rings VMPz 2½–4" XL (PR-3B)</b>	571137R	<b>146,36</b>
<b>XL-Boxx system case with inserts for 3 different pressing rings 64.0–108.0 XL (PR-3S) or 2½–4" XL (PR-3S)</b>	579603R	<b>248,08</b>
<b>Steel case with inserts for adapter tongs Z2 and pressing rings V 42 (PR-2B) and V 54 (PR-2B)</b>	572813R	<b>55,01</b>



# Confirmation of suitability

The suitability of crimping tools is determined basically by the manufacturer of crimping tools. Moreover the suitability of REMS crimping tools has been confirmed by the system manufacturer/supplier himself or approved through independent testing institutes.

## Confirmation of suitability through the system manufacturer/supplier

More than 90 % of the manufacturers/suppliers of the pressfitting systems listed herein have tested REMS pressing tongs and confirmed the suitability for their pressfitting system.

## Confirmation of suitability through independent testing institutes

The suitability of REMS pressing tongs for additional pressfitting systems have been confirmed through independent technical institutes:

### TÜV-Certificates

Exist for Geberit Mepla, Geberit Mapress C-STAHl, Geberit Mapress EDELSTAHL, Geberit Mapress Kupfer, Nussbaum Cupress, Nussbaum Optipress, Uponor Unipipe, Viega-'profipress', Viega-'profipress G', Viega-'sanfix P', Viega-'sanpress', Viega-'Viegatherm P', Wavin Tigris. The TÜV-certificates confirm that REMS crimping tools are suitable for producing perfect and system-conformity pressing joints corresponding to these systems.

### Suitability test according to DVGW W 534 (potable water)

Pressing joints produced with REMS pressing tools were tested by the state-operated material testing institute in Darmstadt/Germany or the material testing institute of the Land of North-Rhine-Westphalia, Germany according to DVGW work sheet W 534. These material testing institutes are certified by the DVGW for making these tests. A representative cross-section of press joints of pressfitting systems Geberit Mapress Edelstahl, Raccorderie Metalliche inoxPRES, Raccorderie Metalliche steelPRES, Uponor Unipipe, Viega Megapress, Viega Profipress and Viega Raxofix. was tested. The tests led to the result that all REMS pressing tools are suitable for producing perfect and system conformity pressing joints in accordance with these systems.

### Suitability test according to DVGW G 5614/VP 625 or prEN 1254-7 (gas)

Pressing joints made with REMS pressing tools have been tested by the TÜV or by the Land Material Testing Institute Nordrhein-Westfalen or the DVGW Research Institute Karlsruhe according to DVGW Regulations G 5614/VP 625 or by the BSI (UK) according to prEN 1254-7. A representative cross-section of pressing joints of the pressfitting systems Geberit Mapress Edelstahl Gas, Geberit Mapress Kupfer Gas, Henco Gas, IBP >B<press Gas, Kembla KemPress Gas, Pegler Yorkshire X-Press Copper Gas, Raccorderie Metalliche inoxPRES Gas, Uponor MLC-G, Valsir PEXAL Gas, Viega Profipress G, Viega Pexfit G, Viega Sanpress INOX G, Viega PropressG GAS System (AUS) was tested. The tests led to the result that all REMS pressing tools are suitable for producing perfect and system conformity pressing joints in accordance with these systems.



potable water



gas

# Hold-Harmless and Indemnification Agreement

## REMS is the first system-independent machine and tool manufacturer to sign liability acceptance agreements for pressing tools.

A hold-harmless and indemnification agreement exists with the:

**Zentralverband Sanitär Heizung Klima (Central Organization for the Sanitary-, Heating- and Climatization Industries),**  
Rathausallee 6, D-53757 St. Augustin,  
referred to in the following as "ZVSHK",

**Bundesindustrieverband Technische Gebäudeausrüstung e.V.,**  
Hinter Hoben 149, 53129 Bonn,  
referred to in the following as "BTGA",

**Verband Deutscher Kälte-Klima-Fachbetriebe e. V. (German Association for Coolant & Air-Conditioning Profession Industries),**  
Kaiser-Friedrich-Straße 7, D-53113 Bonn,  
referred to in the following as "VDKF",

**Schweizerisch-Liechtensteinischem Gebäudetechnikverband (Swiss-Liechtenstein Technical Building Association),**  
Auf der Mauer 11, CH-8023 Zürich,  
referred to in the following as "suissetec",

The Zentralverband Sanitär Heizung Klima (ZVSHK), the Bundesindustrieverband Technische Gebäudeausrüstung e. V. (BTGA), the Verband Deutscher Kälte-Klima-Fachbetriebe e. V. (VDKF) and the Schweizerisch-Liechtensteinische Gebäudetechnikverband (suissetec) have made liability acceptance agreements in the interests of trade and industry with REMS GmbH & Co KG (REMS) for the radial pressing tools.

- Manual radial press REMS Eco-Press
- Cordless radial press REMS Mini-Press 14 V ACC
- Cordless radial press REMS Mini-Press 22 V ACC
- Cordless radial press REMS Mini-Press S 22 V ACC
- Electric radial press REMS Power-Press SE
- Electro-hydraulic radial press REMS Power-Press ACC
- Electro-hydraulic radial press REMS Power-Press XL ACC
- Cordless radial press REMS Akku-Press E 22 V ACC
- Cordless radial press REMS Akku-Press 22 V ACC
- Cordless radial press REMS Akku-Press 22 V Connected
- Cordless radial press REMS Akku-Press XL 45 kN 22 V ACC
- REMS pressing tongs
- REMS pressing rings
- REMS pressing tongs Mini

This makes REMS the first system-independent machine- and tool manufacturer to have concluded a hold-harmless and indemnification agreement for pressing tools. The conclusion of the agreement was effected on the basis of a successful cooperation established on partnership between REMS, the crafts, trades and industry and their organizations.

Eligible for services and performances from this agreement are all independent professional craftsmen, and companies of such, who are enrolled in the register of artisans and craftsmen (referred to in the following as "SHK-Establishments"), in as far as they have been members of the crafts guild of the sanitary- heating- and climatization enterprises competent for their business location at the time the damage event has arisen, and this crafts guild is associated with a regional guild association, which is a member of the ZVSHK.

Entitled to the services from the agreement with the BTGA are all building technology companies (hereinafter referred to as "TGA companies") insofar as they were a member of the Land Industry Association **Technical Building Equipment** responsible at the seat of their company at the time of the damage case and therefore an indirect member of the BTGA or direct member of the BTGA.

Eligible for services and performances from this agreement with the VDKF are all coolant systems companies or professional organisations (referred to as Coolant and Air-Conditioning Profession Industries) who, at the time the damage is caused, are members of the VDKF.

Eligible for services and performances from this agreement are all building systems companies (following TGA companies) who, at the time the damaged is caused, are members of suissetec.

In as far as the radial pressing tools mentioned show a defect with regard to construction, manufacture or material, or if the operator's manuals are faulty, thereby causing damage for the customer of the SHK-establishment, the Coolant and Air-Conditioning Profession Industries, or the TGA-companies, for which the SHK-establishment or the TGA-company is liable, then REMS shall be additionally liable - aside of the statutory prescriptions - for the consequences resulting from leakage, in accordance with the stipulations and provisions of this hold-harmless agreement.

The assumption of liability agreements apply regardless of which pressfitting system is pressed with the suitable REMS pressing tools. The current status regarding suitability of the REMS pressing tools for pressfitting systems can be viewed on the Internet: [www.rems.de](http://www.rems.de) > Downloads > Product catalogues, brochures > REMS Catalogue.

For further information, please contact: [info@rems.de](mailto:info@rems.de)

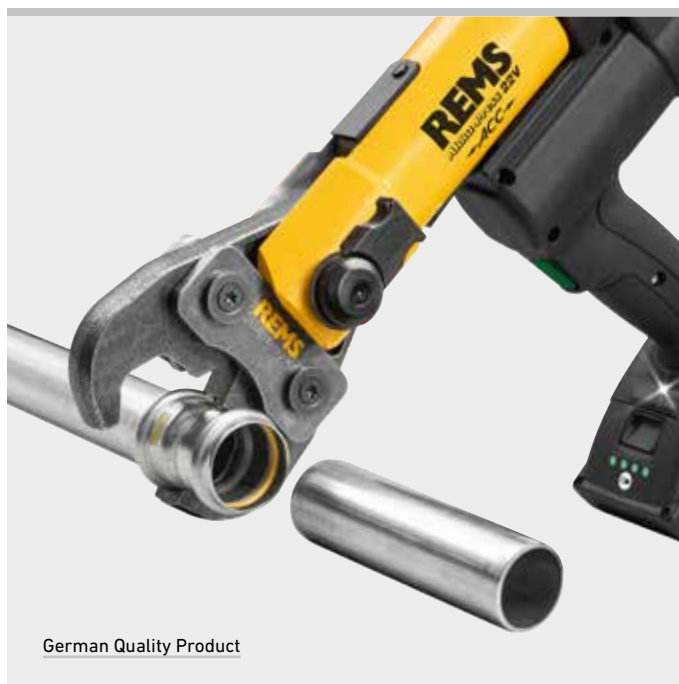

German Quality Product

Reliable and safe: REMS was the first system-independent machine and tool manufacturer to sign liability acceptance agreements for pressing tools as early as the year 2000.





# REMS cropping tongs

Accessories for REMS radial presses (except for REMS Mini-Press) and suitable radial presses of other makes

High performance cropping tongs in forged and specially hardened steel for cutting threaded rods.

Steel, stainless steel up to hardness classification 4.8 (400 N/mm<sup>2</sup>) M 6 – M 12

## REMS cropping tongs – for cutting threaded rods.

Made of forged and specially hardened steel.

Reversible cropping inserts for double service life.

M cropping inserts with high precision thread contour machined on CNC machining centres for exact guiding of the threaded rod in the cutting process. Pliers parts, cropping inserts and specially machined and hardened cutting edges, made to fit exactly, for cutting without burr.

Threaded rod can be screwed into a threaded connection of the pipe clip or the nut without rework after cutting.

Cutting device in pliers design (**Patent EP 1 459 825, patent US 7,284,330**). Driven by REMS radial presses 32 kN and suitable radial presses of other makes with 32 kN thrust force. All cropping tongs marked with \* have an optional connection for manual drive through the radial press REMS Eco-Press.

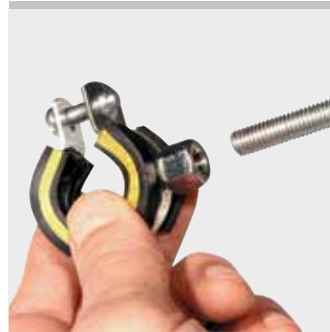
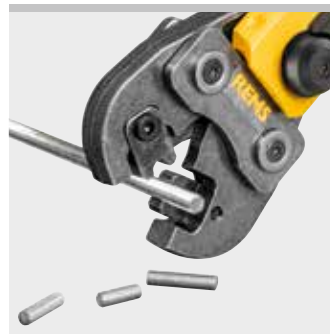

## Supply format

**REMS cropping tongs.** Cropping tongs with 1 pair of reversible cropping inserts for steel, stainless steel, M 6 – M 12. In a carton.

Description	for threaded rods	Art.-No.	€
<b>REMS cropping tongs M 6*</b>	M 6	571890	<b>241,85</b>
<b>REMS cropping tongs M 8*</b>	M 8	571895	<b>241,85</b>
<b>REMS cropping tongs M 10</b>	M 10	571865	<b>241,85</b>
<b>REMS cropping tongs M 12</b>	M 12	571870	<b>241,85</b>

German Quality Product



Patent EP 1 459 825  
Patent US 7,284,330

## Accessories

Description	for threaded rods	Art.-No.	€
<b>Cropping inserts M 6 (pair)</b>	M 6	571891	<b>111,07</b>
<b>Cropping inserts M 8 (pair)</b>	M 8	571896	<b>111,07</b>
<b>Cropping inserts M 10 (pair)</b>	M 10	571866	<b>111,07</b>
<b>Cropping inserts M 12 (pair)</b>	M 12	571871	<b>111,07</b>
<b>Steel case</b> with insert for 6 cropping tongs/pressing tongs and compartment for pipe cutter up to 42 mm		570295R	<b>96,53</b>



# REMS cable shear

Accessories for REMS radial presses (except for REMS Mini-Press) and suitable radial presses of other makes

High-grade cable shear in forged and specially hardened steel for cutting electric cable.

Electric cable ≤ 300 mm<sup>2</sup> (Ø 30 mm)

## REMS cable shear – Easy cutting of electric cable.

Made of forged and specially hardened steel.

Replaceable cutting blades manufactured on CNC production centres ensure a precision blade geometry and long service life. Large cutting range.

Driven by REMS radial presses 32 kN and suitable radial presses of other makes with 32 kN thrust force.

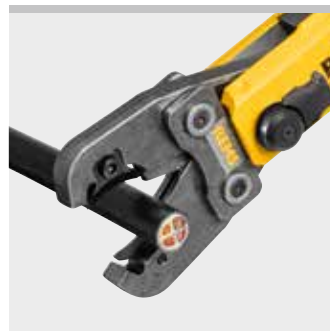

German Quality Product



## Supply format

**REMS cable shear.** Cable shears with 2 changeable cable cutters for electric cables ≤ 300 mm<sup>2</sup> (Ø 30 mm). In a carton.

Description	Art.-No.	€
	571887	<b>396,52</b>



## Accessories

Description	Art.-No.	€
<b>Cable cutters (pack of 2)</b>	571889R02	<b>111,07</b>



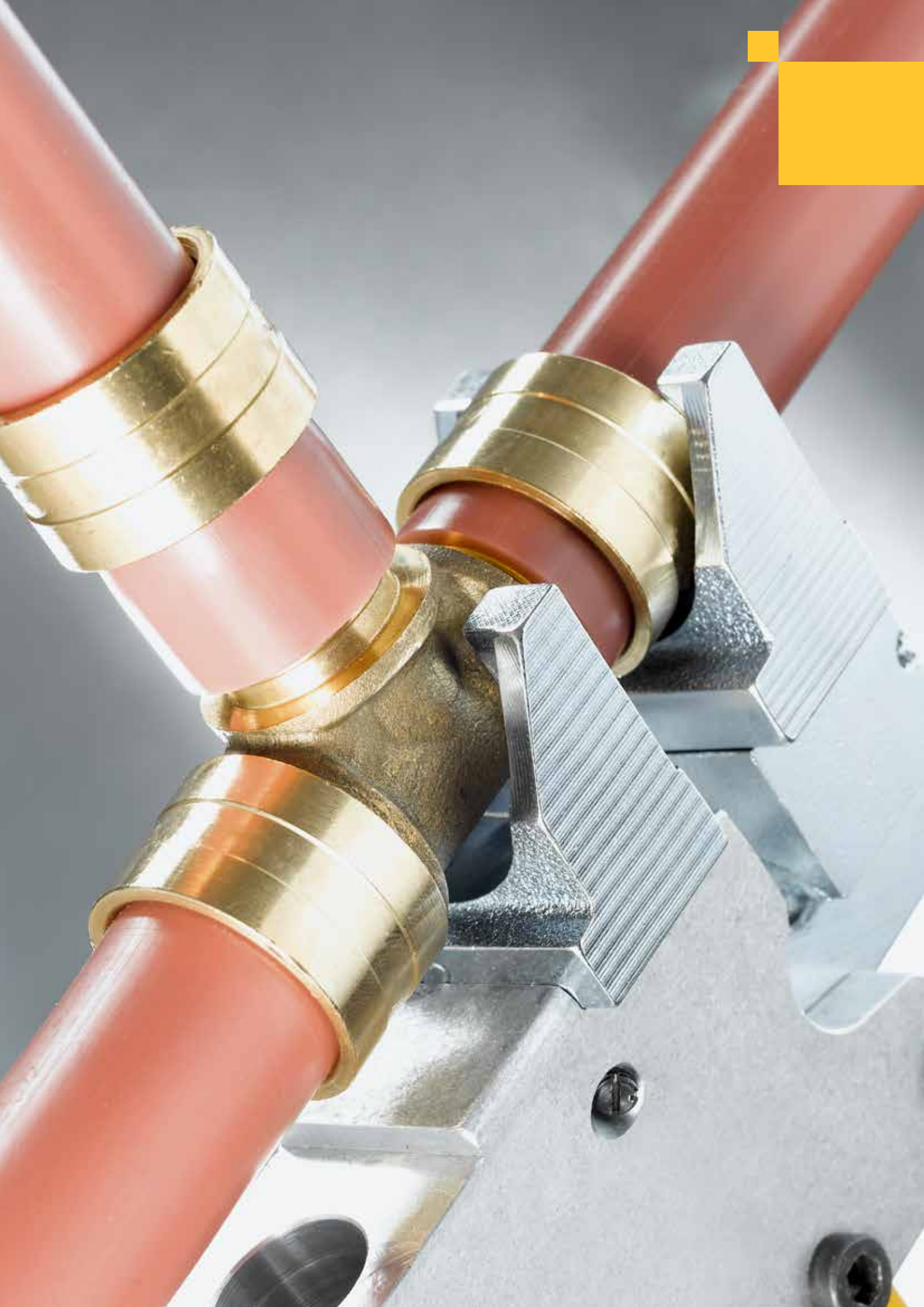

# Axial Press Jointing

	<b>Cordless axial press 30 22V</b> <b>Compression heads</b>	<b>244</b>
	<b>Manual axial press</b>	<b>245</b>
	<b>Cordless axial press 25 22V</b> <b>Cordless axial press 25 L 22V</b>	<b>246</b>
	<b>Compression heads</b>	<b>248</b>

# REMS Ax-Press 30 22V

Cordless axial press 30 kN

Compact, handy electric tool for producing compression sleeve joints with crimping sleeve. For trade and industry. For the building site and the workshop. Li-Ion 22V Technology. For battery and corded operation.

Axial compression  $\varnothing$  12–32 mm

**REMS Ax-Press 30 22V – up to  $\varnothing$  32 mm. Ultra light, ultra small, ultra handy, ultra fast. Li-Ion 21.6 V, 2.5 Ah battery for approx. 220 pressings Georg Fischer pfcI ALUPEX-EXPRESS  $\varnothing$  16 mm with one battery charge\*.**

## Compression heads for all common systems

Complete assortment of REMS compression heads for all common compression sleeve systems with crimping sleeve. High-grade compression heads in forged and specially hardened steel. The REMS compression heads are system-specific and correspond to the respective compression sleeve system. Thus perfect system-conformity, safe jointing.

## Design

Compact, handy, light. Drive unit with battery only 4.6 kg. Vertically from the drive unit located pressing device for seating the compression heads. Can be used anywhere, free hand, over head, in confined spaces. Optimum weight distribution for one-hand operation. Drive unit with inserted compression heads can be put down on the battery ready to pick up. Ergonomically designed housing with soft grip. LED work light for illuminating the work place. Compression heads and expander heads quickly interchangeable, without tools. Secure spring lock seating of compression heads.

## Drive

High pressing force for perfect pressing in seconds, e.g.  $\varnothing$  26 mm in only 5 s. Thrust force 30 kN. Powerful electro-hydraulic drive, eccentric reciprocating pump with robust planetary gear. Powerful electro-hydraulic drive with powerful battery motor 21.6 V, 380 W output, robust planetary gear, eccentric reciprocating pump and compact high power hydraulic system. Safety tip switch.

## Battery or mains operation

Li-Ion 22V Technology. Highly resistant Li-Ion 21.6V battery with 2.5, 4.4, 5.0 or 9.0Ah capacity, for long service life. Light and powerful. Li-Ion 21.6 V, 2.5Ah battery for approx. 220 pressings, 4.4 Ah for approx. 380 pressings, 5.0 Ah for approx. 430 pressings, 9.0Ah for approx. 780 pressings Georg Fischer pfcI ALUPEX-EXPRESS  $\varnothing$  16 mm with one battery charge\*. Graduated charging status check by coloured LEDs. Operating temperature range – 10 to + 60 °C. No memory effect for maximum battery power. Rapid charger 100–240V, 90W. Rapid charger 100–240V, 290W, for shorter charging times, as accessory. Voltage supply 220–240V/21.6V, 15A output, for mains operation instead of Li-Ion battery 21.6 V, as accessory.

## Supply format

**REMS Ax-Press 30 22V Basic-Pack.** Cordless axial press 30 kN for producing compression sleeve joints with crimping sleeve  $\varnothing$  12–32 mm. Electro-hydraulic drive with powerful battery motor 21.6 V, 380 W, robust planetary gear, eccentric reciprocating pump and compact high power hydraulic system, safety tip switch. LED work light. Battery Li-Ion 21.6 V, 2.5 Ah, rapid charger 220–240V, 50–60Hz, 70W. In sturdy steel case.

	Art.-No.	€
	573018R220	2.117,52

## Accessories

Description	Art.-No.	€
<b>REMS Ax-Press 30 22V drive unit, without battery</b>	573008R22	1.577,76
<b>Battery Li-Ion 21.6V, 2.5 Ah</b>	571571R22	258,46
<b>Battery Li-Ion 21.6V, 4.4 Ah</b>	571574R22	372,64
<b>Battery Li-Ion 21.6V, 5.0 Ah</b>	571581R22	310,36
<b>Battery Li-Ion 21.6V, 9.0 Ah</b>	571583R22	414,16
<b>Rapid charger 100–240V, 50–60Hz, 90W</b>	571585R220	175,42
<b>Rapid charger 100–240V, 50–60Hz, 290W</b>	571587R220	414,16
<b>Voltage supply 220–240V/21.6V, 50–60Hz, 15A, for mains operation instead of battery Li-Ion 21.6 V.</b>	571567R220	414,16
<b>Steel case with insert</b>	573282R	110,03

REMS Lumen 2800 22V, cordless LED flood light, see page 111

## REMS compression heads

Compression sleeve system	Compression head	Art.-No.	€
<b>Brasstech Raptor/ Metalpex/ Raptor 2/ MULTitermoSAN</b>	ME 14 (pack of 2)	573100	107,95
	ME 16 (pack of 2)	573102	107,95
	ME 20 (pack of 2)	573106	107,95
	ME 26 (pack of 2)	573108	107,95
	ME 32 (pack of 2)	573110	118,33
<b>General Fittings Serie 5400</b>	ME 14 (pack of 2)	573100	107,95
	ME 16 (pack of 2)	573102	107,95
	ME 20 (pack of 2)	573106	107,95
	ME 26 (pack of 2)	573108	107,95
	ME 32 (pack of 2)	573110	118,33



e.g.  
Brasstech,  
General Fittings,  
Georg Fischer pfcI

German Quality Product



## REMS compression heads

Compression sleeve system	Compression head	Art.-No.	€
<b>Georg Fischer pfcI ALUPEX-EXPRESS/ Alupex Gas System</b>	ME 16 (pack of 2)	573102	107,95
	ME 20 (pack of 2)	573106	107,95
	ME 26 (pack of 2)	573108	107,95
<b>Logstor</b>	ME 16 (pack of 2)	573102	107,95
	LR 20 (pack of 2)	573430	107,95
	LR 22 (pack of 2)	573432	107,95
	LR 25 (pack of 2)	573434	107,95
	LR 28 (pack of 2)	573436	107,95
	LR 32 (pack of 2)	573438	118,33

# REMS Ax-Press HK / H

One-hand axial press / Manual axial press

Universal manual axial press for producing compression sleeve joints.

Axial compression Ø 12 – 32 mm

**REMS Ax-Press HK – universal up to Ø 22 mm**  
Ultra small, ultra light, ultra handy. Only 1.1 kg

**REMS Ax-Press H – universal up to Ø 32 mm.**  
Handy and light. Only 1.4 kg.

**Complete assortment of REMS compression heads, quickly interchangeable.**

### System advantage

Only **one** type of compression heads for REMS Ax-Press HK, REMS Ax-Press H, REMS Ax-Press 25 22V ACC, REMS Ax-Press 25 L 22V ACC. Thus easy, economic stocking.

### Compression heads

Full range of REMS compression heads for all common compression sleeve systems (page 248 – 249). Choice of REMS compression heads with spring lock for seating common compression inserts. High-grade compression heads in forged and specially hardened steel. The REMS compression heads are system-specific and meet the demands of compression sleeve systems. Thus perfect system-conformity, safe jointing.

### Twin compression heads

REMS twin compression heads with two holders each which interleave, for pipe unions of different dimensions (page 248). No need to change compression heads. Extremely simple, saves time.

### Design

Compact, job site proven. Handy and light. REMS Ax-Press HK drive unit only 1.1 kg. REMS Ax-Press H drive unit only 1.4 kg. Works anywhere, free-hand, also in tight spots. 66 mm stroke. Quick-acting forward and release for easy, fast operation. Selectable compression head position (**Patent DE 10 2004 018 429, Patent ES 2 273 563, Patent FR 05 03513**) for pressing compression sleeve connectors with a clamping distance of ≤ 161 mm in one action and for double pressings. Quick-change compression heads and pressing inserts without tools. Secure fit of compression heads and pressing inserts by spring catch. REMS Ax-Press H with overload protection.

### Expanding

Various pipe expanders and complete range of REMS expanding heads for all common compression sleeve systems (page 253 – 257).



Patent DE 10 2004 018 429  
Patent ES 2 273 563  
Patent FR 05 03513

e.g.  
AC-FIX,  
aquatherm,  
BARBI,  
FERRO systems  
BRASELI,  
Brass & Fittings,  
COMAP,  
EUROP'FLUIDES,  
Fittings Estándar,  
PB TUB,  
PLÁSTICOS FERRO,  
REVI,  
RIQUIER,  
TECE,  
TIEMME,  
VELTA



### Supply format

**REMS Ax-Press HK drive unit.** Axial press for single-handed operation for producing compression sleeve joints Ø 12 – 22 mm. 66 mm stroke. With quick-acting forward and release. For driving REMS compression heads. In a carton.

	Art.-No.	€
	574302R	206,56

### Supply format

**REMS Ax-Press H drive unit.** Manual axial press for producing compression sleeve joints Ø 12 – 32 mm. 66 mm stroke. With quick-acting forward and release. For driving REMS compression heads. In a carton.

	Art.-No.	€
	574300RX	289,60

### Accessories

Description	Art.-No.	€
<b>REMS compression heads</b> see page 248 – 249.		
<b>Carrying bag</b> for REMS Ax-Press HK/H drive unit and compression heads	574437R	45,67
<b>Case</b> with inlay for REMS Ax-Press HK drive unit and compression heads	574352R	64,36

German Quality Product



**REMS Ax-Press 25 22V ACC**  
**REMS Ax-Press 25 L 22V ACC**

Cordless axial press 20 kN with automatic return  
 Cordless axial press 13 kN with automatic return

Compact, handy power tool with automatic return for manufacturing compression sleeve joints. Li-Ion 22V Technology. For battery and corded operation. For trade and industry. For the building site and the workshop.

Axial compression  $\varnothing$  12 – 40 mm

**REMS Ax-Press 25 22V ACC – universal up to  $\varnothing$  40 mm. Super light, super handy. Fast. With automatic return. Optimum weight distribution for single-hand operation. Swivelling compression device. Li-Ion 21.6 V, 2.5 Ah battery for approx. 500 pressings REHAU RAUTITAN PX  $\varnothing$  16 mm with one battery charge\*.**

**System advantage**

Only **one** type of compression heads for REMS Ax-Press HK, REMS Ax-Press H, REMS Ax-Press 25 22V ACC, REMS Ax-Press 25 L 22V ACC. Thus easy, economic stocking.

**Compression heads for all common systems**

Full range of REMS compression heads for all common compression sleeve systems (page 248 – 249). Choice of REMS compression heads with spring lock for seating common compression inserts. High-grade compression heads in forged and specially hardened steel. The REMS compression heads are system-specific and meet the demands of compression sleeve systems. Thus perfect system-conformity, safe jointing.

**Twin compression heads**

REMS twin compression heads with two holders each which interleave, for pipe unions of different dimensions (page 248). No need to change compression heads. Extremely simple, saves time.

**Design**

Compact, handy, light. REMS Ax-Press 25 22V ACC drive machine with battery weighs only 3.0 kg, only 28 cm long REMS Ax-Press 25 L 22V ACC drive machine with battery weighs only 3.2 kg, only 31 cm long REMS Ax-Press 25 22V ACC and REMS Ax-Press 25 L 22V ACC with 40 mm stroke respectively REMS Ax-Press 25 22V ACC with preset compression head position for pressing compression sleeve connectors with a clamping distance  $a \leq 82$  mm in one action REMS Ax-Press 25 L 22V ACC with selectable compression head position for pressing compression sleeve connectors with a clamping distance  $a \leq 116$  mm in one action and for double pressings. Works anywhere, free-hand, overhead, in confined areas. Optimum weight distribution for single-hand operation. Ergonomically shaped housing with recessed grip. LED work light for illuminating the work place. Swivelling compression device for working in confined area. Compression heads quickly interchangeable, without tools. Secure spring lock seating of compression heads.

**Drive**

Enormous pressing force for fast and perfect jointing. Thrust force REMS Ax-Press 25 22V 20 kN, thrust force REMS Ax-Press 25 L 22V 13 kN. Powerful electro-hydraulic drive with automatic return (ACC), eccentric reciprocating pump with robust planetary gear. Powerful electro-hydraulic drive with powerful battery motor 21.6 V, 380 W output, robust planetary gear, eccentric reciprocating pump and compact high power hydraulic system. Safety tip switch.

**Battery or mains operation**

Li-Ion 22V Technology. Highly resistant Li-Ion 21.6V battery with 2.5, 4.4, 5.0 or 9.0 Ah capacity, for long service life. Light and powerful. Li-Ion 21.6 V, 2.5 Ah battery for approx. 500 pressings, 4.4 Ah for approx. 880 pressings, 5.0 Ah for approx. 1000 pressings, 9.0 Ah for approx. 1800 pressings REHAU RAUTITAN PX  $\varnothing$  16 mm with one battery charge\*. Graduated charging status check by coloured LEDs. Operating temperature range – 10 to + 60 °C. No memory effect for maximum battery power. Rapid charger 100 – 240V, 90W. Rapid charger 100 – 240V, 290W, for shorter charging times, as accessory. Voltage supply 220 – 240V/21.6 V, 15 A output, for mains operation instead of Li-Ion battery 21.6 V, as accessory.

**Expanding**

Various pipe expanders and complete range of REMS expanding heads for all common pressure sleeve systems

REMS Ax-Press 25 22V ACC



**←ACC→**  
Automatic Circuit Control

with automatic circuit control and charging status check

e.g.  
 aquatherm,  
 General Fittings,  
 IVT,  
 REHAU,  
 REVEL,  
 Seppelfricke,  
 TECE,  
 TIEMME,  
 Würth



REMS Ax-Press 25 L 22V ACC



**←ACC→**  
Automatic Circuit Control

with automatic circuit control and charging status check

e.g.  
 AC-FIX,  
 BARBI,  
 FERRO systems  
 BRASELI,  
 Brass & Fittings,  
 EUROP FLUIDES,  
 Fittings Estándar,  
 PLÁSTICOS FERRO,  
 Velta



German Quality Product



**Supply format**

**REMS Ax-Press 25 22V ACC Basic-Pack.** Cordless axial press 20 kN for producing compression sleeve joints Ø 12–40 mm. 40 mm stroke, for pressing compression sleeve connections with a clamping distance  $a \leq 82$  mm. For driving REMS pressing heads. Electro-hydraulic drive with powerful battery motor 21.6 V, 380 W, robust planetary gear, eccentric reciprocating pump and compact high power hydraulic system, safety tip switch, swivelling pressing device. LED work light. Battery Li-Ion 21.6 V, 2.5 Ah, rapid charger 220–240V or 110 V, 50–60 Hz, 70 W. Without compression heads. In sturdy steel case.

Art.-No.	€
573022R220	<b>1.505,10</b>

Other voltages on request.

**Supply format**

**REMS Ax-Press 25 L 22V ACC Basic-Pack.** Cordless axial press 13 kN for producing compression sleeve joints Ø 12–40 mm. 40 mm stroke, for pressing compression sleeve connections with a clamping distance  $a \leq 116$  mm. For driving REMS pressing heads. Electro-hydraulic drive with powerful battery motor 21.6 V, 380 W, robust planetary gear, eccentric reciprocating pump and compact high power hydraulic system, safety tip switch, swivelling pressing device. LED work light. Battery Li-Ion 21.6 V, 2.5 Ah, rapid charger 220–240V or 110 V, 50–60 Hz, 70 W. Without compression heads. In sturdy steel case.

Art.-No.	€
573023R220	<b>1.505,10</b>

Other voltages on request.

**Accessories**

Description	Art.-No.	€
<b>REMS compression heads</b> see page 248–249.		
<b>REMS Ax-Press 25 22V ACC drive unit,</b> a ≤ 82 mm, without battery	573020R22	<b>1.079,52</b>
<b>REMS Ax-Press 25 L 22V ACC drive unit,</b> a ≤ 116 mm, without battery	573021R22	<b>1.079,52</b>
<b>Battery Li-Ion 21.6 V, 2.5 Ah</b>	571571R22	<b>258,46</b>
<b>Battery Li-Ion 21.6 V, 4.4 Ah</b>	571574R22	<b>372,64</b>
<b>Battery Li-Ion 21.6 V, 5.0 Ah</b>	571581R22	<b>310,36</b>
<b>Battery Li-Ion 21.6 V, 9.0 Ah</b>	571583R22	<b>414,16</b>
<b>Rapid charger 100–240V, 50–60 Hz, 90W</b>	571585R220	<b>175,42</b>
<b>Rapid charger 100–240V, 50–60 Hz, 290W</b>	571587R220	<b>414,16</b>
<b>Voltage supply 220–240V/21.6V, 50–60 Hz, 15 A,</b> for mains operation instead of battery Li-Ion 21.6 V.	571567R220	<b>414,16</b>
<b>Steel case with insert</b>	578290R	<b>110,03</b>
<b>REMS Lumen 2800 22V,</b> cordless LED flood light, see page 111		



Info



Info



# REMS compression heads

Accessories for REMS Ax-Press HK, REMS Ax-Press H, REMS Ax-Press 25 22V ACC, REMS Ax-Press 25 L 22V ACC



## REMS compression heads with spring lock for commercially available press inserts

Description	Use
<b>Compression head Basic 20</b> (pack of 2)	for pipe fittings 20 mm and for standard press inserts outer Ø 20 mm
<b>Compression head Basic 25</b> (pack of 2)	for pipe fittings 25 mm and for standard press inserts outer Ø 25 mm
<b>Compression head Basic 32</b> (pack of 2)	for pipe fittings 32 mm and for standard press inserts outer Ø 32 mm



## REMS twin compression heads

Description	Use
<b>Twin compression head RH 16/20</b> (pack of 2)	for pipe fittings 16 and 20 mm



## REMS compression head for T-pieces, elbows, splitters, transition pieces

Description	Use
<b>Compression head UNI T/L</b> (piece)	for T-pieces, elbows, splitters, in combination with an additional compression head; for transition pieces, in combination with a support bolt



## REMS support bolt for transition pieces

Description	for transition pieces inch	Art.-No.	€
<b>Support bolt 3/8"</b>	3/8	573647R	<b>12,98</b>
<b>Support bolt 1/2"</b>	1/2	573648R	<b>14,95</b>
<b>Support bolt 3/4"</b>	3/4	573649R	<b>16,82</b>

Commercially available press inserts:

T's and elbows

Dm 16

Dm 20

Dm 22

Dm 25

Dm 32





# REMS compression heads

Accessories for REMS Ax-Press HK, REMS Ax-Press H, REMS Ax-Press 25 22V ACC, REMS Ax-Press 25 L 22V ACC

## Select compression heads yourself!

Search for the required compression sleeve system in the table below and select the correct compression heads.

High-grade compression heads in forged and specially hardened steel. Quickly interchangeable, without tools. The REMS compression heads are system-specific and comply with the requirements of the respective compression sleeve system. Thus perfect system-conformity, safe jointing. Drive through REMS axial presses.



Compr. heads Uni



Compr. head UNI T/L

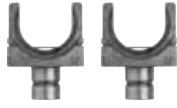

Compr. heads Basic for press inserts

Pressure sleeves system	Compression head mm	Number of pressing heads	fits REMS Ax-Press				Art.-No.	€
			HK <sup>1)</sup>	H	25	25L		
AC-FIX (Global Piping System)	UNI 12	2	•	•		573630	107,95	
	UNI 16	2	•	•		573632	107,95	
	UNI 20	2	•	•		573636	107,95	
	UNI 25	2	•	•		573640	107,95	
	UNI 32	2	•	•		573644	107,95	
	UNI T/L**	1	•	•		573646 R	107,33	
	Basic 20*	2	•	•		573624	119,37	
	Basic 25*	2	•	•		573616	119,37	
aquatherm	AT 16	2	•	•		573120	107,95	
	AT 20	2	•	•		573122	107,95	
	AT 25	2	•	•		573124	107,95	
	AT 32	2	•	•		573126	118,33	
	AT 40	2	•	•		573128	128,71	
	UNI 18	2	•	•		573634	107,95	
	UNI 22	2	•	•		573638	107,95	
	UNI 26	2	•	•		573642	107,95	
BARBI GLADIATOR (Industrial Blansol)	UNI 18	2	•	•		573634	107,95	
	UNI 22	2	•	•		573638	107,95	
	UNI 26	2	•	•		573642	107,95	
	UNI 32	2	•	•		573644	107,95	
	UNI 40	2	•	•		573652	128,71	
	UNI T/L**	1	•	•		573646 R	107,33	
	Basic 20*	2	•	•		573624	119,37	
	Basic 25*	2	•	•		573616	119,37	
BARBI RETICULADO (Industrial Blansol)	UNI 12	2	•	•		573630	107,95	
	UNI 16	2	•	•		573632	107,95	
	UNI 20	2	•	•		573636	107,95	
	UNI 25	2	•	•		573640	107,95	
	UNI 32	2	•	•		573644	107,95	
	UNI 40	2	•	•		573652	128,71	
	UNI T/L**	1	•	•		573646 R	107,33	
	Basic 20*	2	•	•		573624	119,37	
FERRO systems BRASELI GPF AXIAL	UNI 12	2	•	•		573630	107,95	
	UNI 16	2	•	•		573632	107,95	
	UNI 20	2	•	•		573636	107,95	
	UNI 25	2	•	•		573640	107,95	
	UNI 32	2	•	•		573644	107,95	
	UNI T/L**	1	•	•		573646 R	107,33	
	Basic 20*	2	•	•		573624	119,37	
	Basic 25*	2	•	•		573616	119,37	
Brass & Fittings PRESSMAN PowerFit	UNI 16	2	•	•		573632	107,95	
	UNI 20	2	•	•		573636	107,95	
	UNI 25	2	•	•		573640	107,95	
	UNI 32	2	•	•		573644	107,95	
	UNI T/L**	1	•	•		573646 R	107,33	
	Basic 20*	2	•	•		573624	119,37	
	Basic 25*	2	•	•		573616	119,37	
	Basic 32*	2	•	•		573628	119,37	
COMAP PEXY	UNI 12	2	•	•		573630	107,95	
	UNI 16	2	•	•		573632	107,95	
	UNI 20	2	•	•		573636	107,95	
	UNI 25	2	•	•		573640	107,95	
	UNI 32	2	•	•		573644	107,95	
	UNI T/L**	1	•	•		573646 R	107,33	
	Basic 25*	2	•	•		573616	119,37	
	Basic 32*	2	•	•		573628	119,37	
EUROP FLUIDES HYDROFLUIDES	UNI 12	2	•	•		573630	107,95	
	UNI 16	2	•	•		573632	107,95	
	UNI 20	2	•	•		573636	107,95	
	UNI 25	2	•	•		573640	107,95	
	UNI 32	2	•	•		573644	107,95	
	UNI T/L**	1	•	•		573646 R	107,33	
	Basic 25*	2	•	•		573616	119,37	
	Basic 32*	2	•	•		573628	119,37	
Fittings Estándar	UNI 12	2	•	•		573630	107,95	
	UNI 16	2	•	•		573632	107,95	
	UNI 20	2	•	•		573636	107,95	
	UNI 25	2	•	•		573640	107,95	
	UNI 32	2	•	•		573644	107,95	
	UNI T/L**	1	•	•		573646 R	107,33	
	Basic 20*	2	•	•		573624	119,37	
	Basic 32*	2	•	•		573628	119,37	
General Fittings Serie 3400 PEX Gold-Fix	RE 16	2	•	•		573160	107,95	
	RE 20	2	•	•		573162	107,95	
	RE 25	2	•	•		573172	107,95	
	RE 32	2	•	•		573178	107,95	
	RO 16	2	•	•		573184	107,95	
	RO 20	2	•	•		573186	107,95	
General Fittings Serie 3400 PEX/AL/PEX Gold-Fix	RE 16	2	•	•		573160	107,95	
	RE 20	2	•	•		573162	107,95	
	RE 25	2	•	•		573172	107,95	
	RE 32	2	•	•		573178	107,95	
	RO 16	2	•	•		573184	107,95	
	RO 20	2	•	•		573186	107,95	
General Fittings Serie 3400 PEX Gold-Therm	RH 17	2	•	•		573168	107,95	
	RH 20	2	•	•		573170	107,95	
HERZ QUICK FIX	HC 16	2	•	•		573112	107,95	
	HC 20	2	•	•		573114	107,95	
	HC 26	2	•	•		573116	107,95	
	HC 32	2	•	•		573118	118,33	
IVT PRINETO	IV 16/17	3	•	•		573320	161,93	
	IV 20/21	3	•	•		573325	161,93	
	IV 25/26	3	•	•		573330	161,93	
	IV 32/33	3	•	•		573335	161,93	

Pressure sleeves system	Compression head mm	Number of pressing heads	fits REMS Ax-Press				Art.-No.	€
			HK <sup>1)</sup>	H	25	25L		
PB TUB Setrigliss	UNI 12	2	•	•		573630	107,95	
	UNI 16	2	•	•		573632	107,95	
	UNI 20	2	•	•		573636	107,95	
	UNI 25	2	•	•		573640	107,95	
	UNI 32	2	•	•		573644	107,95	
	UNI T/L**	1	•	•		573646 R	107,33	
	Basic 25*	2	•	•		573616	119,37	
	Basic 32*	2	•	•		573628	119,37	
PLÁSTICOS FERRO FERROPLAST GPF AXIAL	UNI 16	2	•	•		573632	107,95	
	UNI 20	2	•	•		573636	107,95	
	UNI 25	2	•	•		573640	107,95	
	UNI 32	2	•	•		573644	107,95	
	UNI T/L**	1	•	•		573646 R	107,33	
	Basic 20*	2	•	•		573624	119,37	
	Basic 25*	2	•	•		573616	119,37	
	Basic 32*	2	•	•		573628	119,37	
PLUMBING PLUS EZIPEX Sleeve Water (AUS)	RH 16 L	2		•	•	573150	107,95	
	RH 20 L	2		•	•	573152	107,95	
	RH 16/20 L	2		•	•	573158	215,90	
	RH 25	2		•	•	573154	107,95	
	RH 32	2		•	•	573156	118,33	
		2		•	•	573150	107,95	
PLUMBING PLUS EZIPEX Sleeve Gas (AUS)	RH 20 L	2		•	•	573152	107,95	
	RH 16/20 L	2		•	•	573158	215,90	
	RH 25	2		•	•	573154	107,95	
	RH 32	2		•	•	573156	118,33	
		2		•	•	573162	107,95	
		2		•	•	573170	107,95	
REHAU RAUTHERM SDR 11 LX	RH 16	2	•	•		573166	107,95	
	RH 20	2	•	•		573170	107,95	
	RH 25	2	•	•		573154	107,95	
	RH 32	2	•	•		573156	118,33	
		2	•	•		573168	107,95	
REHAU RAUTHERM S (REHAU HAS)	RH 20	2	•	•		573170	107,95	
	RH 25	2	•	•		573154	107,95	
	RH 32	2	•	•		573156	118,33	
		2	•	•		573160	107,95	
		2	•	•		573162	107,95	
REHAU RAUTITAN PX/MX/SX/RX/ gas/sprinkler	RE 16	2	•	•		573160	107,95	
	RE 20	2	•	•		573162	107,95	
	RE 25	2	•	•		573172	107,95	
	RE 32	2	•	•		573178	107,95	
	RE 40	2	•	•		573176	128,71	
REHAU (GBR) EVERLOC	RH 16	2	•	•		573166	107,95	
	RH 20	2	•	•		573170	107,95	
	RH 25	2	•	•		573154	107,95	
	RH 32	2	•	•		573156	118,33	
REVEL-PEX	RV 16	2	•	•		573400	107,95	
	RV 20	2	•	•		573402	107,95	
	RV 25	2	•	•		573404	107,95	
	RV 32	2	•	•		573406	118,33	
REVI REVIUNI	TC 12/14/16	2		•	•	573360	107,95	
	TC 18/20	2		•	•	573364	107,95	
	TC 25	2		•	•	573367	107,95	
	TC 32	2		•	•	573370	118,33	
REVI REVITERM Riquier à glissement	UNI 12	2	•	•		573630	107,95	
	UNI 16	2	•	•		573632	107,95	
	UNI 20	2	•	•		573636	107,95	
	UNI 25	2	•	•		573640	107,95	
Seppelfricke SD Sistemi Italia Sylver	UNI 32	2	•	•		573644	107,95	
	UNI T/L**	1	•	•		573646 R	107,33	
	Basic 25*	2	•	•		573616	119,37	
		2	•	•		573160	107,95	
		2	•	•		573162	107,95	
		2	•	•		573172	107,95	
		2	•	•		573178	107,95	
		2	•	•		573184	107,95	
		2	•	•		573186	107,95	
		2	•	•		573160	107,95	



# Expanding Extracting

	<b>Hand tube expander Cu</b>	<b>252</b>
	<b>Expander head Cu</b>	<b>252</b>
	<b>One-hand pipe expander</b>	<b>253</b>
	<b>Hand tube expander P</b>	<b>253</b>
	<b>Cordless pipe expander Cu</b>	<b>254</b>
	<b>Cordless pipe expander P</b>	<b>254</b>
	<b>Cordless pipe expander P-CEF</b>	<b>254</b>
	<b>Electro-hydraulic pipe expander P-CEF</b>	<b>256</b>
	<b>Expander head P Expander head P-CEF</b>	<b>257</b>
	<b>Hand tube extractor</b>	<b>258</b>
	<b>Electric tube extractor Electric tube expander</b>	<b>259</b>

Proven quality tool for expanding and calibrating pipes for pipe installation without fittings.

Soft copper tubes  $s \leq 1.5$  mm  $\varnothing$  8–42 mm  
 $\varnothing$   $\frac{3}{8}$ – $1\frac{1}{8}$ "

Soft aluminium tubes,  
soft precision steel tubes  $s \leq 1.2$  mm  $\varnothing$  8–42 mm  
 $\varnothing$   $\frac{3}{8}$ – $1\frac{1}{8}$ "

Soft stainless steel tubes  $s \leq 1$  mm  $\varnothing$  8–42 mm  
 $\varnothing$   $\frac{3}{8}$ – $1\frac{1}{8}$ "

**REMS Ex-Press Cu – for making sockets yourself.**  
**6-face mandrel for even and concentric expanding.**  
**Extra long sockets according to DVGW. Expander heads with calibration neck, fit other makes as well.**

### Cost advantage

Pipe installation without fittings. No costs for fittings, storage, procurement. Savings in soldering joints, soldering material and working hours. Using up pipe pieces to provide sockets.

### Design

Robust quality tool. Torsion-free, power-transmitting expander levers with ergonomically designed handles, for effortless expanding. 6-face mandrel for even and concentric expanding. Extra long sockets, spring-loaded return of mandrel release. Also for other suitable makes of expander heads.

### Expander heads

Quick-change. Extra long expander heads result in extra long sockets for perfect pipe connections according to DVGW. Special neck at expander head specially for calibration of deformed pipe ends.



German Quality Product



Info

### Supply format

**REMS Ex-Press Cu Set.** Hand tube expander  $\varnothing$  8–42 mm,  $\varnothing$   $\frac{3}{8}$ – $1\frac{1}{8}$ ". Soft copper tubes  $\varnothing$  8–42 mm,  $\varnothing$   $\frac{3}{8}$ – $1\frac{1}{8}$ ",  $s \leq 1.5$  mm, soft aluminium tubes and soft steel precision tubes  $\varnothing$  8–42 mm,  $\varnothing$   $\frac{3}{8}$ – $1\frac{1}{8}$ ",  $s \leq 1.2$  mm, soft stainless steel tubes  $\varnothing$  8–42 mm,  $\varnothing$   $\frac{3}{8}$ – $1\frac{1}{8}$ ",  $s \leq 1$  mm. Expander drive. Choice of expander heads for pipes in mm or inch. In sturdy steel case.

Description	Art.-No.	€
Set 12 + 15 + 18 + 22	150000R	467,10
Set 12 + 15 + 22 + 28	150005R	482,67
Set 15 + 18 + 22 + 28	150006R	482,67
Set 12 + 15 + 18 + 22 + 28	150007R	544,95
Set 12 + 14 + 16 + 18 + 22 + 28 + 32	150008R	679,89
Set 12 + 14 + 16 + 18 + 22	150010R	539,76
Set $\frac{3}{8}$ + $\frac{1}{2}$ + $\frac{5}{8}$ + $\frac{3}{4}$ + $\frac{7}{8}$ + $1\frac{1}{8}$ "	150017R	643,56
Set $\frac{1}{2}$ + $\frac{3}{8}$ + $\frac{7}{8}$ + $1\frac{1}{8}$ "	150018R	508,62
Set $\frac{3}{8}$ + $\frac{1}{2}$ + $\frac{5}{8}$ + $\frac{3}{4}$ "	150019R	487,86
Set $\frac{3}{8}$ + $\frac{1}{2}$ + $\frac{5}{8}$ + $\frac{3}{4}$ + $\frac{7}{8}$ + $1$ "	150020R	643,56



### Accessories

Description	Pipes $\varnothing$ mm/inch	Art.-No.	€
<b>Expander head Cu</b> (fit expander drives of REMS Ex-Press Cu 22 V ACC and other makes also)	8	150100R	64,67
	10	150105R	64,67
	12	150110R	64,67
	14	150120R	64,67
	15	150125R	64,67
	16	150130R	64,67
	18	150140R	64,67
	20	150145R	90,51
	22	150150R	64,67
	24	150155R	103,38
	25	150160R	90,51
	26	150165R	77,54
	28	150170R	77,54
	30	150175R	103,38
	32	150180R	77,54
	34	150185R	103,38
	35	150190R	103,38
	36	150195R	103,38
40	150205R	103,38	
42	150210R	90,51	
<b>Expander drive Cu</b> (taper angle 18°)	$\frac{3}{8}$ "	150220R	64,67
	$\frac{1}{2}$ "	150225R	64,67
	$\frac{5}{8}$ "	150230R	64,67
	$\frac{3}{4}$ "	150235R	77,54
	$\frac{7}{8}$ "	150240R	77,54
	1"	150245R	90,51
	$1\frac{1}{8}$ "	150250R	90,51
<b>Expander drive Cu</b> (taper angle 18°)	150500R	180,61	
<b>Steel case with insert</b>	150600R	55,01	



# REMS Ex-Press H

One-hand pipe expander

Robust, compact quality tool for expanding tubes.  
For one-hand operation.

PEX tubes Serie S 5 according to ISO 4065 Ø 12–40 mm

## REMS Ex-Press H – universal up to Ø 40 mm.

Robust, compact quality tool. Super light, only 0.7 kg.  
Stepped mandrels for expanding several tube dimensions, no tool change required.  
Torsion-free, leveraged expander tool for effortless expanding.  
For one-hand operation.

### Supply format

**REMS Ex-Press H.** One-hand pipe expander for PEX tubes Serie S 5 according to ISO 4065 Ø 12–40 mm. In a carton.

	Art.-No.	€
	150550R	<b>196,18</b>



German Quality Product



# REMS Ex-Press P

Hand tube expander

Proven quality tool for expanding tubes.  
Plastic tubes, multi-layer composite tubes Ø 12–32 mm

## REMS Ex-Press P – for expanding tubes. Conical mandrel for even and concentric expanding.

### Design

Robust quality tool. Torsion-free, power-transmitting expander levers with ergonomically designed handles, for effortless expanding. Conical mandrel (taper angle 18°) for even and concentric expanding. Long mandrel guidance, spring-loaded mandrel release. Also for other suitable makes of expander heads.

### Expander heads for all common systems

Complete assortment of REMS expander heads P for all common compression sleeve systems (page 257). Quickly interchangeable, without tools. The REMS expander heads are system-specific and comply with the requirements of the respective compression sleeve system. Thus perfect system-conformity, exact expanding.

### Supply format

**REMS Ex-Press P Set.** Hand tube expander for plastic tubes and multi-layer composite tubes Ø 12–32 mm. REMS Ex-Press P. Expander heads P for tubes in mm. In sturdy steel case.

Description	Compr. sleeve system	Art.-No.	€
<b>Set AT P 16 + 20 + 25</b>	aquatherm SHT PB/PE-Rohre	150021R	<b>591,66</b>
<b>Set AT V 16 + 20 + 25</b>	aquatherm SHT Mehrschicht-Metall- verbundrohre	150033R	<b>591,66</b>
<b>Set IV 16/17 + 20/21 + 25/26</b>	IVT PRINETO, Würth PRINETO	150026R	<b>591,66</b>
<b>Set RH HAS 17 + 20 + 25</b>	REHAU RAUTHERM S (REHAU HAS), General Fittings Serie 3400 PEX Gold-Therm	150027R	<b>591,66</b>
<b>Set RH HIS 16 + 20 + 25</b>	REHAU RAUTITAN flex/ gas flex/pink/his, General Fittings Serie 3400 PEX, REVEL, Seppelfricke SD Sistemi Italia Neroflex, TIEMME Assialpex	150028R	<b>591,66</b>
<b>Set RH MKV 16 + 20 + 25</b>	REHAU RAUTITAN stabil/ gas stabil, General Fittings Serie 3400 PEX/AL/PEX, Seppelfricke SD Sistemi Italia Sylver	150022R	<b>591,66</b>
<b>Set RH 16 + 20 + 25</b>	REHAU RAUTHERM (série S 5), REHAU (GBR) EVERLOC	150029R	<b>591,66</b>
<b>Set TC 16 + 18/20 + 25</b>	TECE TECEflex	150025R	<b>591,66</b>

System-specific and/or national differences of the wall thickness (s) of tubes need to be considered selecting expander heads, see table page 257.

### Accessories

Description	Art.-No.	€
<b>Expander heads P</b> see page 257.		
<b>Expander drive REMS Ex-Press P</b> (taper angle 18°)	150510R	<b>204,49</b>
<b>Steel case</b> with insert	150600R	<b>55,01</b>



German Quality Product



e.g.  
aquatherm,  
General Fittings,  
IVT,  
REHAU,  
REVEL,  
Seppelfricke,  
TECE,  
TIEMME,  
Würth



# REMS Ex-Press 22V ACC

Cordless pipe expander 20 kN with automatic return

Compact, handy power tool with automatic return for fast, easy expansion of pipes/rings. Li-Ion 22V Technology. For cordless and mains operation. For trade and industry. For the building site and the workshop.

## Expander Cu

for holding the REMS Cu expander heads and suitable expander heads of other makes for:

Soft copper pipes,  $s \leq 1.5 \text{ mm}$   $\varnothing 8 - 42 \text{ mm}$   
 $\varnothing \frac{3}{8} - 1\frac{3}{4}''$

Soft aluminium pipes,  
soft precision steel pipes,  $s \leq 1.2 \text{ mm}$   $\varnothing 8 - 42 \text{ mm}$   
 $\varnothing \frac{3}{8} - 1\frac{3}{4}''$

Soft stainless steel pipes,  $s \leq 1 \text{ mm}$   $\varnothing 8 - 42 \text{ mm}$   
 $\varnothing \frac{3}{8} - 1\frac{3}{4}''$

## Expander P

for holding the REMS P expander heads and suitable expander heads of other makes for:

Plastic tubes, composite tubes  $\varnothing 12 - 40 \text{ mm}$

## Expander P-CEF

for holding the REMS P-CEF expander heads and suitable expander heads of other makes for:

Cold Expansion Fittings made of plastic (P-CEF)  
 $\varnothing 16 - 40 \text{ mm}$   
 $\varnothing \frac{1}{2} - 1\frac{1}{2}''$   
 $s \leq 4.95 \text{ mm}$

**REMS Ex-Press 22V ACC – fast, easy electric expanding up to  $\varnothing 42 \text{ mm}$ . With automatic return. Conical expanding mandrel for even centric expanding. E.g. REMS Ex-Press Cu 22V ACC with Li-Ion 21.6 V, 2.5 Ah battery for approx. 600 expansions of soft copper pipe  $15 \times 1 \text{ mm}$  with one battery charge\*.**

## System advantage

Only **one** drive unit, optionally with **expander Cu** for holding the REMS Cu expander heads and suitable expander heads of other makes, **expander P** for holding the REMS P expander heads and suitable expander heads of other makes, **expander P-CEF** for holding the REMS P-CEF expander heads and suitable expander heads of other makes.

## Expander heads for all common systems

Quick-change, without tools. Also for other suitable makes of expander tongs.

**REMS expander heads Cu** (page 252) with extra long segments provide an extra long muff for a perfect pipe joint in accordance with DVGW. Collar on the expander head for calibrating unround pipe ends.

**REMS expander heads P** (page 257) are system-specific and correspond to the requirements of the respective compression sleeve systems. Therefore, perfectly system-conformant, exact expanding.

**REMS expander heads P-CEF** (page 257) are system-specific and correspond to the requirements of the respective systems. Automatic, gradual expansion until reaching the given end position which is determined by the expander head.

## Design

Ultra light, ultra small, ultra handy. Drive unit with battery pack weighs only 2.7 kg. Drive unit with expander only 26 cm long. Can therefore be used anywhere, free hand, over head, also in very confined spaces. Optimum weight distribution for one-hand operation. Ergonomically designed housing. LED work light for illuminating the work place. Expanding mandrel of the Cu and P expanders with conical angle  $18^\circ$ , expanding mandrel of the P-CEF expander with conical angle  $20^\circ$ , or even centric expanding. Long mandrel guide, spring-loaded mandrel recoil. Also for other suitable makes of expander heads.

## Drive

High expanding force for perfect, split-second expanding. Thrust force 20 kN. Powerful electro-hydraulic drive with automatic return (ACC), with powerful battery motor 21.6V, 380W output, robust planetary gear, eccentric reciprocating pump and compact high power hydraulic system. Safety switch.



REMS Ex-Press Cu

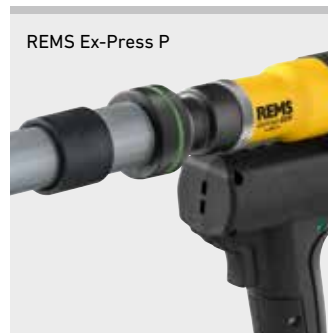

REMS Ex-Press P



REMS Ex-Press P-CEF

German Quality Product



Info

## Battery or mains operation

Li-Ion 22V Technology. Highly resistant Li-Ion 21.6V battery with 2.5, 4.4, 5.0 or 9.0 Ah capacity, for long service life. Light and powerful.

**REMS Ex-Press Cu 22V ACC** with Li-Ion 21.6 V, 2.5 Ah battery for approx. 600 expansions, 4.4 Ah for approx. 1050 expansions, 5.0 Ah for approx. 1200 expansions, 9.0 Ah for approx. 2160 expansions of soft copper pipe  $15 \times 1 \text{ mm}$  with one battery charge\*.

**REMS Ex-Press P 22V ACC** with Li-Ion 21.6 V, 2.5 Ah battery for approx. 750 expansions, 4.4 Ah for approx. 1320 expansions, 5.0 Ah for approx. 1500 expansions, 9.0 Ah for approx. 2700 expansions of REHAU RAUTITAN flex  $\varnothing 16 \times 2.2 \text{ mm}$  with one battery charge\*.

**REMS Ex-Press P-CEF 22V ACC** with Li-Ion 21.6 V, 2.5 Ah battery for approx. 200 expansions, 4.4 Ah for approx. 360 expansions, 5.0 Ah for approx. 410 expansions, 9.0 Ah for approx. 740 expansions of Uponor Quick & Easy  $\varnothing 16 \times 1.8$  with one battery charge\*.

Graduated charging status check by coloured LEDs. Operating temperature range  $-10$  to  $+60^\circ\text{C}$ . No memory effect for maximum battery power. Rapid charger 100–240V, 90W. Rapid charger 100–240V, 290W, for shorter charging times, as accessory. Voltage supply 220–240V/21.6 V, 15 A output, for mains operation instead of Li-Ion xbattery 21.6 V, as accessory.

## Supply format

**REMS Ex-Press Cu 22V ACC Basic-Pack.** Cordless pipe expander 20 kN for fast expanding of copper pipes Ø 8–42 mm. Electro-hydraulic drive with automatic return, with powerful 21.6V, 380W battery motor, robust planetary gear, eccentric reciprocating pump and compact high power hydraulic system, safety switch. LED work light. Li-Ion 21.6V, 2.5Ah battery, 220–240V, 50–60 Hz, 70W rapid charger. Cu expander for holding the REMS Cu expander heads and suitable expander heads of other makes. Without expander heads. In sturdy steel case.

	Art.-No.	€
	575020R220	<b>1.505,10</b>

Other voltages on request.



## Supply format

**REMS Ex-Press P 22V ACC Basic-Pack.** Cordless pipe expander 20 kN for fast expanding of plastic and composite tubes Ø 12–40 mm. Electro-hydraulic drive with automatic return, with powerful 21.6V, 380W battery motor, robust planetary gear, eccentric reciprocating pump and compact high power hydraulic system, safety switch. LED work light. Li-Ion 21.6V, 2.5Ah battery, 220–240V, 50–60 Hz, 70W rapid charger. P expander for holding the REMS P expander heads and suitable expander heads of other makes. Without expander heads. In sturdy steel case.

	Art.-No.	€
	575021R220	<b>1.505,10</b>

Other voltages on request.



e.g.  
aquatherm,  
General Fittings,  
IVT,  
REHAU,  
REVEL,  
Seppelfricke,  
TECE,  
TIEMME,  
Würth

## Supply format

**REMS Ex-Press P-CEF 22V ACC Basic-Pack.** Cordless pipe expander 20 kN for fast expanding of plastic tubes Ø 16–40 mm. Electro-hydraulic drive with automatic return, with powerful 21.6V, 380W battery motor, robust planetary gear, eccentric reciprocating pump and compact high power hydraulic system, safety switch. LED work light. Li-Ion 21.6V, 2.5Ah battery, 220–240V, 50–60 Hz, 70W rapid charger. P-CEF expander for holding the REMS P-CEF expander heads and suitable expander heads of other makes. Without expander heads. In sturdy steel case.

	Art.-No.	€
	575022R220	<b>1.505,10</b>

Other voltages on request.



e.g.  
Brass & Fittings,  
Uponor

## Accessories

Description	Art.-No.	€
<b>REMS Ex-Press 22V ACC drive unit,</b> without expander, without battery	575010R22	<b>1.079,52</b>
<b>Expander Cu</b> for holding the REMS Cu expander heads and suitable expander heads of other makes for: Conical angle 18°.	575252R	<b>77,23</b>
<b>Expander heads Cu</b> see page 252		
<b>Expander P</b> for holding the REMS P expander heads and suitable expander heads of other makes for: Conical angle 18°.	575253R	<b>77,23</b>
<b>Expander heads P</b> see page 257.		
<b>Expander P-CEF</b> for holding the REMS P-CEF expander heads and suitable expander heads of other makes for: Conical angle 20°.	575256R	<b>77,23</b>
<b>Expander heads P-CEF</b> see page 257.		
<b>Expander tongs P-CEF</b> (conical angle 20°), for accommodating the expander heads P-CEF 16–40 mm, ½–1½"	150515R	<b>204,49</b>
<b>Battery Li-Ion 21.6V, 2.5 Ah</b>	571571R22	<b>258,46</b>
<b>Battery Li-Ion 21.6V, 4.4 Ah</b>	571574R22	<b>372,64</b>
<b>Battery Li-Ion 21.6V, 5.0 Ah</b>	571581R22	<b>310,36</b>
<b>Battery Li-Ion 21.6V, 9.0 Ah</b>	571583R22	<b>414,16</b>
<b>Rapid charger 100–240V, 50–60 Hz, 90W</b>	571585R220	<b>175,42</b>
<b>Rapid charger 100–240V, 50–60 Hz, 290W</b>	571587R220	<b>414,16</b>
<b>Voltage supply 220–240V/21.6V, 50–60 Hz, 15A,</b> for mains operation instead of battery Li-Ion 21.6 V.	571567R220	<b>414,16</b>
<b>Steel case</b> with insert	578290R	<b>110,03</b>
<b>REMS Lumen 2800 22V,</b> cordless LED flood light, see page 111		



# REMS Power-Ex-Press P-CEF ACC

Electro-hydraulic pipe expander 34 kN with automatic return

Compact, handy power tool for fast, easy expanding of pipes/rings. For trade and industry. For the building site and the workshop.

Cold Expansion Fittings made of plastic (P-CEF)

Ø 16–63 mm

Ø ½–2"

s ≤ 6.3 mm

**REMS Power-Ex-Press P-CEF ACC – Fast, easy electric expanding up to Ø 63 mm. With automatic return. For Uponor Quick & Easy and Giacomini GX System.**

## Expander heads

Large expanding capacity up to Ø 63 mm. Automatic, gradual expansion until reaching the given end position which is determined by the expander head. Use of the REMS P-CEF expander heads and suitable expander heads of other makes for: Expander 50–63 mm, 2", for holding the REMS P-CEF expander heads 50–63 mm, 2" and suitable expander heads of other makes. Expander 16–40 mm, ½–1½", for holding the REMS P-CEF expander heads 16–40 mm, ½–1½" and suitable expander heads of other makes, as an accessory.

## Execution

Compact, robust, job site-proven. Small in size, slender design, drive unit only 5.6 kg. Works anywhere, free-hand, overhead, in confined areas. Ideal weight distribution for single handed operation. Ergonomically designed housing with recessed grip.

## Drive

High pressing force for fast, perfect expanding. Thrust force 34 kN. Powerful electro-mechanical drive with automatic return (ACC), with proven universal motor, 450 W, maintenance-free gear with safety slipping clutch and in-feed system with machine screw spindle. Safety tip switch.



German Quality Product



## Supply format

**REMS Power-Ex-Press P-CEF ACC Basic-Pack.** Electro-hydraulic pipe expander 34 kN for expanding tubes/coils of the Uponor Quick & Easy system Ø 16–63 mm, Ø ½–2", s ≤ 6.3 mm. Electro-hydraulic drive with automatic retraction, with proven universal motor 230 V or 110 V, 50–60 Hz, 450 W, robust planetary gear, eccentric reciprocating pump and compact high power hydraulic system. Safety tip switch. Expanding device 50–63 mm, 2". Without expander heads. In sturdy steel case.

	Art.-No.	€
	575017R220	<b>1.462,54</b>

Note assembly instructions of system supplier. Battery tube expander for other systems on request. Other voltages on request.

## Accessories

Description	Art.-No.	€
<b>Expander 16–40 mm, ½–1½"</b> , for holding the P-CEF expander heads 16–40 mm, ½–1½"	575100R	<b>122,48</b>
<b>Expander heads P-CEF</b> see page 257.		
<b>Steel case with insert</b>	575278R	<b>110,03</b>





## REMS expander heads P REMS expander heads P-CEF

### REMS expander heads P

Complete assortment of REMS expander heads P for all common compression sleeve systems. Quickly interchangeable, without tools. The REMS expander heads are system-specific and comply with the requirements of the respective compression sleeve system. Thus perfect system-conformity, exact expanding. Conical angle 18°. Driven by REMS Ex-Press P hand pipe expander (page 253), REMS Ex-Press P 22 V ACC cordless pipe expander (page 254–255) and by suitable pipe expanders of other makes.

Compression sleeve system	Expander head P Ø × s	Art.-No.	€
<b>aquatherm grey pipe PB/PE-RT-Rohre</b>	AT P 14 × 2,0	150828	<b>120,41</b>
	AT P 16 × 2,0	150842	<b>120,41</b>
	AT P 18 × 2,0	150873	<b>120,41</b>
	AT P 20 × 2,0	150882	<b>120,41</b>
	AT P 25 × 2,3	150912	<b>120,41</b>
<b>aquatherm grey pipe Mehrschicht- Metallverbundrohre (MVR)</b>	AT V 16 × 2,4	150843	<b>120,41</b>
	AT V 20 × 2,4	150883	<b>120,41</b>
	AT V 25 × 2,7	150913	<b>120,41</b>
	AT V 32 × 3,2	150957	<b>129,75</b>
	AT V 40 × 3,5	150958	<b>142,21</b>
<b>General Fittings Serie 3400 PEX Gold-Fix</b>	RH HIS 16 × 2,2	150849	<b>120,41</b>
	RH HIS 20 × 2,8	150888	<b>120,41</b>
	RH HIS 25 × 3,5	150916	<b>120,41</b>
	RH HIS 32 × 4,4	150945	<b>120,41</b>
<b>General Fittings Serie 3400 PEX/AL/PEX Gold-Fix</b>	RH MKV 16,2 × 2,6	150858	<b>120,41</b>
	RH MKV 20 × 2,9	150897	<b>120,41</b>
	RH MKV 25 × 3,7	150926	<b>120,41</b>
	RH MKV 32 × 4,7	150952	<b>120,41</b>
<b>General Fittings Serie 3400 PEX Gold-Therm</b>	RH HAS 17 × 2,0	150868	<b>120,41</b>
	RH HAS 20 × 2,0	150887	<b>120,41</b>
<b>HERZ QUICK FIX</b>	HC P 16 × 2,0	150806	<b>120,41</b>
	HC P 20 × 2,0	150807	<b>120,41</b>
	HC P 26 × 3,0	150808	<b>120,41</b>
	HC P 32 × 3,0	150809	<b>120,41</b>
<b>IVT PRINETO</b>	IV 16 × 2,2/17 × 2,8	150845	<b>120,41</b>
	IV 20 × 2,8/21 × 3,4	150885	<b>120,41</b>
	IV 25 × 3,5/26 × 4,0	150914	<b>120,41</b>
	IV 32 × 4,4/33 × 4,9	150943	<b>129,75</b>
<b>REHAU RAUTHERM (série S 5)</b>	RH 12 × 1,1	150812	<b>120,41</b>
	RH 16 × 1,5	150846	<b>120,41</b>
	RH 20 × 1,9	150886	<b>120,41</b>
	RH 25 × 2,3 (RH HAS 25 × 2,3)	150915	<b>120,41</b>
	RH 32 × 2,9 (RH HAS 32 × 2,9)	150944	<b>120,41</b>
<b>REHAU RAUTHERM S (REHAU HAS)</b>	RH HAS 17 × 2,0	150868	<b>120,41</b>
	RH HAS 20 × 2,0	150887	<b>120,41</b>
	RH HAS 25 × 2,3	150915	<b>120,41</b>
	RH HAS 32 × 2,9	150944	<b>120,41</b>
<b>REHAU RAUTITAN flex/ RAUTITAN gas flex/ RAUTITAN pink/ RAUTITAN his</b>	RH HIS 16 × 2,2	150849	<b>120,41</b>
	RH HIS 20 × 2,8	150888	<b>120,41</b>
	RH HIS 25 × 3,5	150916	<b>120,41</b>
	RH HIS 32 × 4,4	150945	<b>120,41</b>
	RH HIS 40 × 5,5	150946	<b>129,75</b>
<b>REHAU RAUTITAN stabil/ RAUTITAN gas stabil</b>	RH MKV 16,2 × 2,6	150858	<b>120,41</b>
	RH MKV 20 × 2,9	150897	<b>120,41</b>
	RH MKV 25 × 3,7	150926	<b>120,41</b>
	RH MKV 32 × 4,7	150952	<b>120,41</b>
	RH MKV 40 × 6,0	150947	<b>129,75</b>
<b>REHAU (GBR) EVERLOC</b>	RH 16 × 1,5	150846	<b>120,41</b>
	RH 20 × 1,9	150886	<b>120,41</b>
	RH 25 × 2,3 (RH HAS 25 × 2,3)	150915	<b>120,41</b>
	RH 32 × 2,9 (RH HAS 32 × 2,9)	150944	<b>120,41</b>
<b>REVEL</b>	RH HIS 16 × 2,2	150849	<b>120,41</b>
	RH HIS 20 × 2,8	150888	<b>120,41</b>
	RH HIS 25 × 3,5	150916	<b>120,41</b>
	RH HIS 32 × 4,4	150945	<b>120,41</b>
<b>Seppelfricke SD Sistemi Italia Neroflex</b>	RH HIS 16 × 2,2	150849	<b>120,41</b>
	RH HIS 20 × 2,8	150888	<b>120,41</b>
	RH HIS 25 × 3,5	150916	<b>120,41</b>
	RH HIS 32 × 4,4	150945	<b>120,41</b>
<b>Seppelfricke SD Sistemi Italia Sylver</b>	RH MKV 16,2 × 2,6	150858	<b>120,41</b>
	RH MKV 20 × 2,9	150897	<b>120,41</b>
	RH MKV 25 × 3,7	150926	<b>120,41</b>
	RH MKV 32 × 4,7	150952	<b>120,41</b>
<b>TECE TECEflex</b>	TC 12/14	150826	<b>120,41</b>
	TC 16	150855	<b>120,41</b>
	TC 18/20	150894	<b>120,41</b>
	TC 25	150923	<b>120,41</b>
	TC 32	150950	<b>120,41</b>
<b>TIEMME Assialpex</b>	RH HIS 16 × 2,2	150849	<b>120,41</b>
	RH HIS 20 × 2,8	150888	<b>120,41</b>
	RH HIS 25 × 3,5	150916	<b>120,41</b>
	RH HIS 32 × 4,4	150945	<b>120,41</b>

System-specific and/or national differences of the wall thickness (s) of tubes need to be considered selecting expander heads. REMS expander heads P for additional compression sleeve systems on request.

## Accessories for REMS pipe expander and other makes

### Choose expander heads yourself!

Search for the required compression sleeve system in the table below and select the correct expander heads.

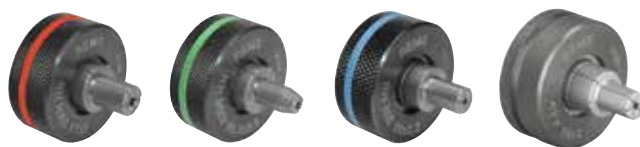

German Quality Product

### REMS expander heads P

Complete assortment of REMS expander heads P for all common compression sleeve systems. Quickly interchangeable, without tools. The REMS expander heads are system-specific and comply with the requirements of the respective compression sleeve system. Thus perfect system-conformity, exact expanding. Conical angle 18°. Driven by REMS Ex-Press P hand pipe expander (page 253), REMS Ex-Press P 22 V ACC cordless pipe expander (page 254–255) and by suitable pipe expanders of other makes.

Compression sleeve system	Expander head P Ø × s	Art.-No.	€
<b>Würth PRINETO</b>	IV 16 × 2,2/17 × 2,8	150845	<b>120,41</b>
	IV 20 × 2,8/21 × 3,4	150885	<b>120,41</b>
	IV 25 × 3,5/26 × 4,0	150914	<b>120,41</b>
	IV 32 × 4,4/33 × 4,9	150943	<b>129,75</b>

System-specific and/or national differences of the wall thickness (s) of tubes need to be considered selecting expander heads. REMS expander heads P for additional compression sleeve systems on request.



### REMS expander heads P-CEF

Full range of REMS P-CEF expander heads for easy expanding of pipes/rings. Quick-change, without tools. The REMS P-CEF expander heads are system-specific and correspond to the requirements of the respective systems. Therefore, perfectly system-conformant, exact expanding. Conical angle 20°. Driven by REMS Ex-Press P-CEF 22 V ACC cordless pipe expander (page 254–255), REMS Power-Ex-Press P-CEF ACC electro-hydraulic pipe expander (page 256) and by suitable pipe expanders of other makes.

Compression sleeve system	Expander head P-CEF Ø × s	Art.-No.	€
<b>Uponor Quick &amp; Easy</b>	P-CEF 16 × 1.8	150960R	<b>129,75</b>
	P-CEF 20 × 1.9	150961R	<b>129,75</b>
	P-CEF 25 × 2.3	150962R	<b>129,75</b>
	P-CEF 32 × 2.9	150963R	<b>129,75</b>
	P-CEF 40 × 3.7	150968R	<b>142,21</b>

**Expander drive P-CEF** (taper angle 20°), for holding the P-CEF expander heads 16–40 mm, ½–1½"

System-related and/or national differences of the wall thickness s of the pipes must be considered in the selection of the expander heads.

# REMS Hurrigan H

Hand tube extractor

Economic manual tool for efficiently making T-branches for pipe installations without fittings.

Hard and soft copper tubes	Ø 10–22 mm
	Ø 3/8–7/8"
	s ≤ 1.5 mm

**REMS Hurrigan H – for making T-branches yourself. Inexpensive. Also on tubes already installed.**

### System advantage

Only **one** type of extractor tools for REMS Hurrigan H, REMS Hurrigan and REMS Twist/Hurrigan. Simple, inexpensive storage. No confusion possible.

### Cost advantage

No costs for T-pieces, storage, procurement. Savings in soldering joints, pressing joints and working hours. Higher safety by fewer tube joints.

### Design

Compact, handy, light. Can be used anywhere, free-hand, on pipes already installed. Drill head for exact drilling start without centre punching, drilling depth stop according to size of the T-outlet. Limitation of insertion depth to avoid obstruction by using the dimpling pliers. Handy gripping tongs for fixing the tool holder on the pipe, as an accessory.

### Drill head drive

Drive with conventional electric drill.

### Extractor tools

Special design of extractor tools facilitate even and smooth material deformation without burrs and notches. Therefore no secondary treatment required.

### Tool holder drive

With standard ratchet and hexagon socket 11 mm or with spanner. Upgrade to electric pipe neck expander by buying the REMS Twist/Hurrigan drive machine.



German Quality Product



Info



### Supply format

**REMS Hurrigan H Set.** Hand tube extractor for hard and soft copper tubes Ø 10–22 mm, Ø 3/8–7/8", s ≤ 1.5 mm. Tool holder, drill head, dimpling pliers, lubricant. Extractor tools for tubes in mm or inch. In sturdy case.

Description	Art.-No.	€
Set 12 + 15 + 18 + 22	151003R	550,14
Set 12 + 14 + 16 + 18 + 22	151004R	612,42
Set 3/8 + 1/2 + 5/8 + 3/4 + 7/8"	151005R	633,18

### Accessories

Description	Tubes Ø mm/inch	Art.-No.	€
<b>Extractor tool</b>	10	151105R	67,89
	12	151110R	67,89
	14	151120R	67,89
	15	151125R	67,89
	16	151130R	67,89
	18	151140R	67,89
	20	151145R	67,89
	22	151150R	67,89
	3/8"	151155R	72,04
	1/2"	151160R	69,96
	5/8"	151165R	69,96
3/4"	151170R	69,96	
7/8"	151175R	69,96	

<b>REMS Twist/Hurrigan drive unit with stabiliser</b>	151402R220	371,60
<b>Grip wrench for clamping the tool holder</b>	076117	109,92
<b>Tool holder</b>	151200R	85,32
<b>Drill head</b>	151210RMM	127,67
<b>Dimpling pliers</b>	151230R	40,48
<b>Ratchet 1/2"</b>	074021	76,71
<b>Hexagon socket 11 mm</b>	074041	7,79
<b>Lubricant (tin)</b>	151240	9,34
<b>Case with inlay</b>	151618R	53,98



Powerful, compact electric tool for efficient machining of T-branches of hard and soft tubes for tube installations without fittings.

Hard and soft copper tubes  $\varnothing$  10–22 mm  
 $\varnothing$  3/8–7/8"  
 $s \leq 1.5$  mm

**REMS Hurrigan – for making T-branches yourself. Inexpensive. Also on tubes already installed.**

**System advantage**

Only one type of extractor tools for REMS Hurrigan H, REMS Hurrigan and REMS Twist/Hurrigan. Simple, inexpensive storage. No confusion possible.

**Cost advantage**

No costs for T-branches, storage, procurement. Savings in soldering joints, soldering material and working hours. Higher safety by fewer tube joints.

**Design**

Compact, handy, light. Can be used anywhere, free-hand, on pipes already installed. Drill head provides precise drilling without punching with any standard power drill. Drill depth-stop according to the size of T-branch. Tool holder for holding the extractor tools. Limitation of insertion depth to avoid obstruction by using the dimpling pliers. Handy grip wrench for clamping the tool holder onto the pipe.

**Drive**

Proven drive unit with hexagon mount. Enormously powerful. Handy, light, only 1.5 kg. Can be used anywhere, free-hand, also on pipes already installed. Robust, maintenance-free gear with safety slipping clutch. Universal motor, 630 W, high-torque forward and reverse at low speed. Stepless, electronic speed control. The speed can be continuously controlled electronically by variable pressure on the safety switch from 0 to 1,000 rpm (accelerator switch).

**Extractor tools**

Special design of extractor tools facilitate even and smooth material deformation without burrs and notches. Therefore no secondary treatment required.

**REMS Twist/Hurrigan**

Space and weight-saving combination set for efficient production of T-branches and for efficient cold-expanding of hard and soft tubes for installations without fittings. Only one drive unit for expanding and extracting tools. Price advantage! See page 261.



German Quality Product



Info



**Supply format**

**REMS Hurrigan Set.** Electric tube extractor for hard and soft copper tube  $\varnothing$  10–22 mm,  $\varnothing$  3/8–7/8",  $s \leq .5$  mm. Drive unit with hexagon mount, maintenance-free gear, universal motor 230 V or 110 V, 50–60 Hz, 630 W. High torque at low speed, left and right-hand rotation. Safety tip switch. Continuous, electronic speed control from 0 to 1,000 rpm (accelerator switch). Drive holder. Tool holder, drill head, dimpling pliers, lubricant. Extractor tools for pipes in mm or inch. In sturdy steel case.

Description	Art.-No.	€
Set 12 + 15 + 18 + 22	151000R220	985,06
Set 12 + 14 + 16 + 18 + 22	151010R220	1.048,38
Set 3/8 + 1/2 + 5/8 + 3/4 + 7/8"	151002R220	1.058,76

Other voltages on request.



**Accessories**

Description	Tubes $\varnothing$ mm/inch	Art.-No.	€
<b>Extractor tool</b>	10	151105R	67,89
	12	151110R	67,89
	14	151120R	67,89
	15	151125R	67,89
	16	151130R	67,89
	18	151140R	67,89
	20	151145R	67,89
	22	151150R	67,89
	3/8"	151155R	72,04
	1/2"	151160R	69,96
	5/8"	151165R	69,96
	3/4"	151170R	69,96
	7/8"	151175R	69,96
<b>REMS Twist/Hurrigan drive unit with stabiliser</b>		151402R220	371,60
<b>Tool holder</b>		151200R	85,32
<b>Drill head</b>		151210RMM	127,67
<b>Dimpling pliers</b>		151230R	40,48
<b>Lubricant (tin)</b>		151240	9,34
<b>Case with inlay</b>		151618R	53,98



Powerful, compact power tool for rational cold expanding of hard and soft copper pipes for pipe installation without fittings.

Hard and soft copper tubes  $\varnothing$  12–22 mm  
 $\varnothing$   $\frac{3}{8}$ – $\frac{7}{8}$ "  
 $s \leq 1$  mm

### REMS Twist – for making sockets yourself. Cold-expanding of hard copper pipes.

#### Cost advantage

No costs for annealing hard copper tubes, for deburring and cleaning, for fittings, storage, procurement. Savings in soldering joints, soldering material and working hours. Higher safety by fewer tube joints. Using up tube pieces to make sockets.

#### Design

Compact, robust, job site-proven. Simple and fast working free-hand, at vice or workbench. No adjustments. Integrated clamping device provides safe support against torque in both directions.

#### Drive

Proven drive unit with hexagon mount. Enormously powerful. Handly, light, only 1.5 kg. Can be used anywhere, free-hand, also on pipes already installed. Robust, maintenance-free gear with safety slipping clutch. Universal motor, 630 W, high-torque forward and reverse at low speed. The speed can be continuously controlled electronically by variable pressure on the safety switch from 0 to 1,000 rpm (accelerator switch).

#### Expander tools

One quick-changing expander tool of each tube size with rotating mandrel for easy expanding and smooth operation. Without annealing, standard socket in just a few seconds, extra long.

#### REMS Twist/Hurricane

Space and weight-saving combination set for efficient production of T-branches and for efficient cold-expanding of hard and soft tubes for installations without fittings. Only one drive unit for expanding and extracting tools. Price advantage! See page 261.



German Quality Product



#### Supply format

**REMS Twist Set.** Electric tube expander for hard and soft copper tubes  $\varnothing$  12–22 mm,  $\varnothing$   $\frac{3}{8}$ – $\frac{7}{8}$ ",  $s \leq 1$  mm. Drive unit with hexagon mount, maintenance-free gear, universal motor 230 V or 110 V, 50–60 Hz, 630 W. High torque at low speed, left and right-hand rotation. Safety tip switch. Continuous, electronic speed control from 0 to 1,000 rpm (accelerator switch). Drive holder. Lubricant. Expander tools for mm or inch. In sturdy steel case.

Description	Art.-No.	€
<b>Set 12 + 15 + 18 + 22</b>	156000R220	<b>1.078,48</b>
<b>Set 12 + 14 + 16 + 18 + 22</b>	156002R220	<b>1.242,49</b>
<b>Set <math>\frac{3}{8}</math> + <math>\frac{1}{2}</math> + <math>\frac{5}{8}</math> + <math>\frac{3}{4}</math> + <math>\frac{7}{8}</math>"</b>	156004R220	<b>1.242,49</b>

Other voltages on request.

#### Accessories

Description	Tubes $\varnothing$ mm/inch	Art.-No.	€
<b>Expander tool</b>	12	156150	<b>173,35</b>
	14	156200	<b>173,35</b>
	15	156225	<b>173,35</b>
	16	156250	<b>173,35</b>
	18	156300	<b>173,35</b>
	22	156350	<b>173,35</b>
	$\frac{3}{8}$ "	156375	<b>173,35</b>
	$\frac{1}{2}$ "	156400	<b>173,35</b>
	$\frac{5}{8}$ "	156425	<b>173,35</b>
	$\frac{3}{4}$ "	156450	<b>173,35</b>
	$\frac{7}{8}$ "	156475	<b>173,35</b>
<b>REMS Twist/Hurricane drive unit with stabiliser</b>		151402R220	<b>371,60</b>
<b>Lubricant (tin)</b>		151240	<b>9,34</b>
<b>Steel case with insert</b>		151600R	<b>110,03</b>



# REMS Twist/Hurrican

Electric tube extractor  
Electric tube expander

Powerful, compact power tool for rational manufacture of T-joints and rational cold expanding of hard and soft copper pipes for pipe installation without fittings. Combination of REMS Twist and REMS Hurrican.

**Extracting:**

Hard and soft copper tubes  $\varnothing 10 - 22 \text{ mm}$   
 $\varnothing \frac{3}{8} - \frac{7}{8}''$   
 $s \leq 1.5 \text{ mm}$

**Expanding:**

Hard and soft copper tubes  $\varnothing 12 - 22 \text{ mm}$   
 $\varnothing \frac{3}{8} - \frac{7}{8}''$   
 $s \leq 1 \text{ mm}$

**REMS Hurrican for making T-branches yourself.  
Inexpensive. Also on tubes already installed.**

**REMS Twist for making sockets yourself.  
Cold-expanding of hard copper tubes.**

Space and weight saving combi set. Only **one** drive unit for expander and extractor tools. Price advantage!

Description see REMS Hurrican and REMS Twist (page 259 – 260).



German Quality Product



Info

**Supply format**

**REMS Twist/Hurrican Combi Set.** Electric tube expander and electric tube extractor for hard and soft copper tubes. Expanding  $\varnothing 12 - 22 \text{ mm}$ ,  $\varnothing \frac{3}{8} - \frac{7}{8}''$ ,  $s \leq 1 \text{ mm}$ , extracting  $\varnothing 10 - 22 \text{ mm}$ ,  $\varnothing \frac{3}{8} - \frac{7}{8}''$ ,  $s \leq 1.5 \text{ mm}$ . Drive unit with hexagonal mount, maintenance-free gear, universal motor 230 V or 110 V, 50 – 60 Hz, 630 W. High torque at low speed, left and right-hand rotation. Stepless, electronic safety switch. Drive holder. Tool holder, drill head, dimpling pliers, lubricant. Choice of expander and extractor tools for pipes in mm or inch. In sturdy steel case.

Description	Art.-No.	€
<b>Set 12 + 15 + 18 + 22</b>	156010R220	<b>1.542,47</b>
<b>Set 12 + 14 + 16 + 18 + 22</b>	156012R220	<b>1.782,25</b>
<b>Set <math>\frac{3}{8}</math> + <math>\frac{1}{2}</math> + <math>\frac{5}{8}</math> + <math>\frac{3}{4}</math> + <math>\frac{7}{8}''</math></b>	156014R220	<b>1.835,18</b>

Other voltages on request.



**Accessories**

Description	Tubes $\varnothing \text{ mm/inch}$	Art.-No.	€
<b>Expander tool</b>	12	156150	<b>173,35</b>
	14	156200	<b>173,35</b>
	15	156225	<b>173,35</b>
	16	156250	<b>173,35</b>
	18	156300	<b>173,35</b>
	22	156350	<b>173,35</b>
	$\frac{3}{8}''$	156375	<b>173,35</b>
	$\frac{1}{2}''$	156400	<b>173,35</b>
	$\frac{5}{8}''$	156425	<b>173,35</b>
	$\frac{3}{4}''$	156450	<b>173,35</b>
$\frac{7}{8}''$	156475	<b>173,35</b>	
<b>Extractor tool</b>	10	151105R	<b>67,89</b>
	12	151110R	<b>67,89</b>
	14	151120R	<b>67,89</b>
	15	151125R	<b>67,89</b>
	16	151130R	<b>67,89</b>
	18	151140R	<b>67,89</b>
	20	151145R	<b>67,89</b>
	22	151150R	<b>67,89</b>
	$\frac{3}{8}''$	151155R	<b>72,04</b>
	$\frac{1}{2}''$	151160R	<b>69,96</b>
$\frac{5}{8}''$	151165R	<b>69,96</b>	
$\frac{3}{4}''$	151170R	<b>69,96</b>	
$\frac{7}{8}''$	151175R	<b>69,96</b>	
<b>REMS Twist/Hurrican drive unit with stabiliser</b>		151402R220	<b>371,60</b>
<b>Tool holder</b>		151200R	<b>85,32</b>
<b>Drill head 10 – 22 mm</b>		151210RMM	<b>127,67</b>
<b>Drill head <math>\frac{3}{8} - \frac{7}{8}''</math></b>		151210RMM	<b>127,67</b>
<b>Dimpling pliers</b>		151230R	<b>40,48</b>
<b>Lubricant (tin)</b>		151240	<b>9,34</b>
<b>Steel case with insert</b>		151600R	<b>110,03</b>



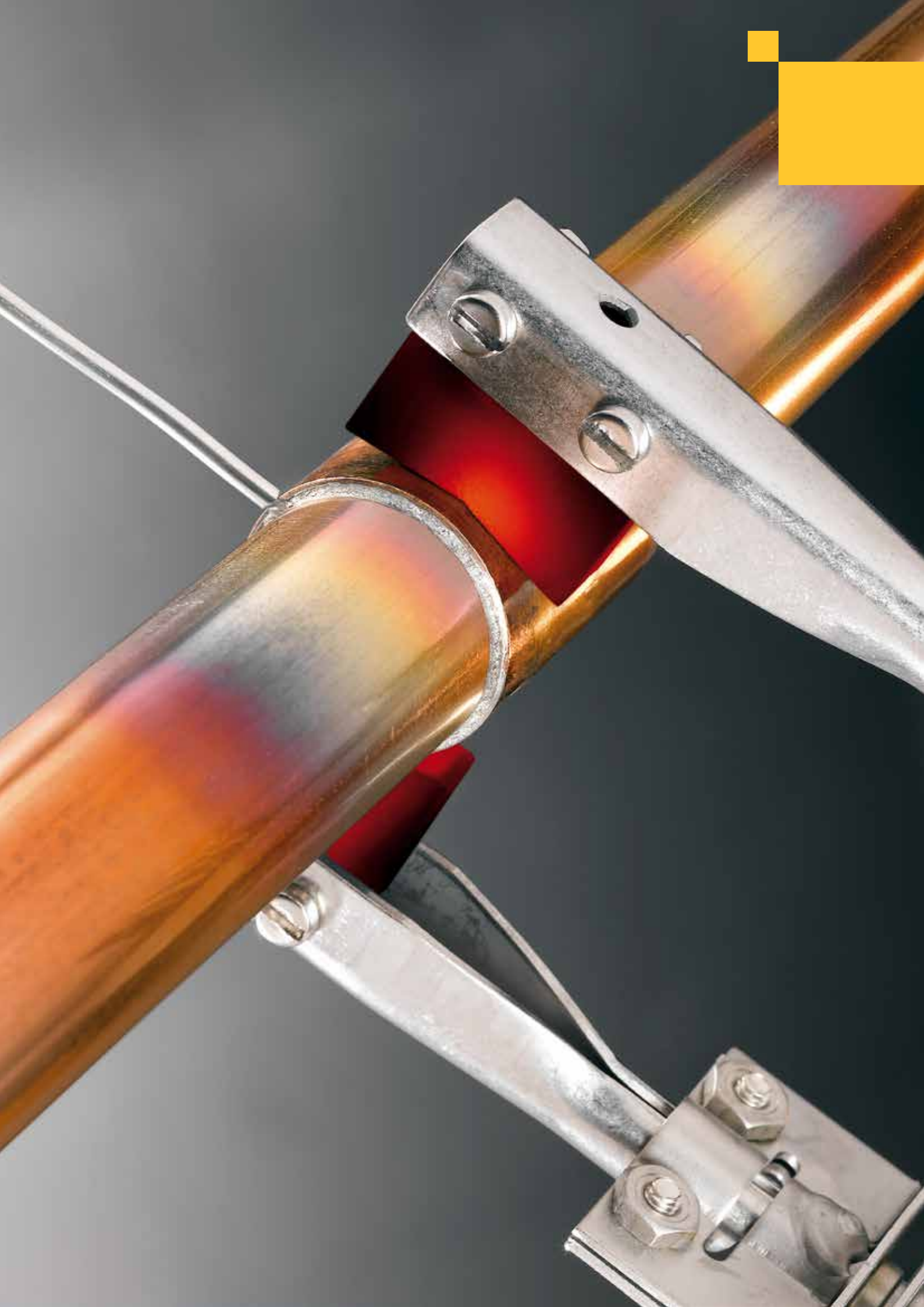

# Soldering

	<b>Cleaning pads</b>	<b>264</b>
	<b>Electric soldering pliers</b>	<b>264</b>
	<b>Electric soldering unit</b>	<b>265</b>
	<b>Turbo soldering torches</b>	<b>266</b>
	<b>Solder wire and solder paste</b>	<b>267</b>

# REMS Cu-Vlies

Cleaning pads

Metal-free, highly flexible cleaning pads for cleaning surfaces to be soldered on copper tubes and soldering fittings. Also for other materials.

## REMS Cu-Vlies – clean surfaces according to DVGW.

Universal use, for many materials, highly flexible. Cleans metallic clear, dirt and oxide-free, according to DVGW work sheet GW 2. Clean finish. Multiple use, reusable by washing out, thus long service life. Can be used wet or dry.

### Supply format

**REMS Cu-Vlies.** Metal-free, highly flexible cleaning pad for cleaning areas to be soldered on copper pipes and soldering fittings. Pack of 10.

	Art.-No.	€
	160300R	<b>10,28</b>



German Quality Product

# REMS Hot Dog 2

Electric soldering pliers

Efficient, light-weight electric tool for soft soldering. Directly connected to a socket, no transformer required. For trade and industry. For the building site and the workshop.

Copper tubes	Ø 10 – 28 mm Ø 3/8 – 1 1/8"
Heating capacity	800°C

## REMS Hot Dog 2 – the smallest and most powerful soldering pliers. Super fast without flame.

Super fast soldering, e.g. Ø 18 mm in only 15 s. Enormous heating capacity up to 800°C through 2 heating cartridges. For permanent use.

Super light and handy, complete only 0.7 kg. Can be used anywhere, in confined areas also.



German Quality Product



Info

### Supply format

**REMS Hot Dog 2 Set.** Electric soldering pliers for soft soldering copper tubes Ø 10 – 28 mm, Ø 3/8 – 1 1/8". 230 V, 50 – 60 Hz, 440 W. 250 g REMS Lot Cu 3 and REMS Paste Cu 3. Cleaning brush. In steel case with fire retarding insert.

	Art.-No.	€
	163020R220	<b>455,68</b>

Other voltages on request.

### Accessories

Description	Art.-No.	€
<b>REMS soldering material</b> see page 267.		
<b>Steel case with fire-proof inlay</b>	163350R	<b>76,81</b>





# REMS Contact 2000

Electric soldering unit

Compact, powerful electric tool for soft soldering. With safety transformer. For trade and industry. For the building site and the workshop.

Copper tubes	Ø 6–54 mm Ø ¼–2½"
Heating capacity	900°C (1650°F)

**REMS Contact 2000 – the smallest, strongest and fastest unit of its kind. 2000 W soldering power. 4 m long soldering tongs cable.**

Handy, compact. Favourable weight, small in size for work and transport. L × W × H: 210 × 150 × 140 mm.

Enormous heating capacity (900°C) ensures super-fast soldering. Rated power = Soldering capacity = 2000 W! Soldering time, e.g. for Ø 18 mm in only 18 s.

Can be used anywhere, with rod electrodes in tight spots also. Ready to solder any time, to be connected to a socket only. No adjustment of soldering current necessary. Wide work radius thanks to 4 m cable length. Flexible cable protector hose.

Indifferent to temperature influences electric control of soldering current.

Prisma-electrodes for universal use, maximum use through favorable seat. Rod-electrodes for working in tight spots. Electrode holders and bolts in stainless steel. Electrodes can be easily replaced.



Prisma-electrodes for universal use, maximum use through favorable seat.

German Quality Product



Info

## Supply format

**REMS Contact 2000.** Electric soldering unit for soft soldering of copper tubes Ø 6–54 mm, Ø ¼–2½". 230 V, 50–60 Hz, 2000 W, control voltage 24 V. Soldering pliers with 4 m cable length. Safety transformer, 2 prism electrodes. In a carton.

	Art.-No.	€
	164011R220	799,26

Other voltages on request.

## Supply format

**REMS Contact 2000 Super-Pack.** Electric soldering unit for soft soldering of copper tubes Ø 6–54 mm, Ø ¼–2½". 230 V or 110 V, 50–60 Hz, 2000 W, control voltage 24 V. Soldering pliers with 4 m cable length, safety transformer, 4 prism electrodes, 2 rod electrodes, 250 g quality soft solder REMS Lot Cu 3, 250 g quality soft solder paste REMS Paste Cu 3, 1 pipe cutter REMS RAS Cu-INOX 3-35, pack of 10 cleaning pads REMS Cu-Vlies. In sturdy steel case.

	Art.-No.	€
	164050R220	995,44



## Accessories

Description	Art.-No.	€
<b>Prism electrodes (pack of 2)</b>	164111R	25,43
<b>Prism electrodes with holders (pack of 2)</b>	164110R	42,77
<b>Rod electrodes (pack of 2)</b>	164115R	26,47
<b>Steel case with insert</b>	164250R	128,71

REMS soldering material see page 267.



# REMS Blitz

## Turbo soldering torch propane

Handy self-lighting torch with turbo-flame for fast soft soldering and economic gas consumption.

Copper tubes  $\leq \varnothing 35 \text{ mm}$

Heating, annealing, burning, melting, thawing, shrinking and similar thermal procedures.

Flame temperature  $1950^{\circ}\text{C}$  ( $3500^{\circ}\text{F}$ )

### REMS Blitz – extremely fast soft soldering.

#### Piezo-electric self-lighting

Without igniter! Pull trigger – flame comes on! Release trigger – flame goes out! Little gas consumption, only 200 g/h!

#### Design

Super handy, ergonomic, with one hand only. No setting, no adjustment. Locking button for continuous operation. Only 1 universal flame tube. Small gas bottles can be used.

#### Turbo-flame

Spot-flame with turbo-twisting-booster for high heating capacity and super fast soft soldering.



German Quality Product



Info



### Supply format

**REMS Blitz.** Turbo soldering torch propane for soft soldering of copper tubes  $\leq \varnothing 35 \text{ mm}$ . Piezo-electric self-lighting. Hose connector BSPP  $\frac{3}{8}$ " LH. Hollow cap nut and socket BSPP  $\frac{3}{8}$ " LH. In blister pack.

	Art.-No.	€
	160010R	243,93

### Accessories

Description	Art.-No.	€
<b>REMS soldering material</b> see page 267.		
<b>High pressure hose 3 m</b> , BSPP $\frac{3}{8}$ " LH	152106	90,41
<b>Pressure reducer</b> for 5 or 11 kg gas bottles (2 bar)	152109	116,36



# REMS Macho

## Turbo soldering torch acetylene

Handy self-lighting torch with turbo-flame for extremely fast brazing and soft soldering. Economic gas consumption.

Copper tubes and others  $\leq \varnothing 64 \text{ mm}$

Heating, annealing, burning, melting, thawing, shrinking and similar thermal procedures.

Flame temperature  $2500^{\circ}\text{C}$

### REMS Macho – super fast brazing.

#### Piezo-electric self-lighting

Without igniter! Pull trigger – flame comes on! Release trigger – flame goes out! Little gas consumption, only 360 g/h!

#### Acetylene only

Injection torch burns atmospheric oxygen. Hence only acetylene necessary.

#### Design

Super handy, ergonomic, with one hand only. No setting, no adjustment. Locking button for continuous operation. Only 1 universal flame tube.

#### Turbo-flame

Spot-flame with turbo-twisting-booster for extremely high heating capacity and super fast brazing.



German Quality Product



Info



### Supply format

**REMS Macho.** Turbo soldering torch acetylene for brazing and soft soldering of copper tubes and others  $\leq \varnothing 64 \text{ mm}$ . Piezo-electric self-lighting. Hose connector BSPP  $\frac{3}{8}$ " LH. Hollow cap nut and socket  $\frac{3}{8}$ " LH. In blister pack.

	Art.-No.	€
	161010R	268,84

### Accessories

**REMS soldering material** see page 267.

# REMS Lot Cu 3

Soft solder Sn97Cu3, ISO 9453:2014

Soft soldering of copper tubes with copper, red copper cast and brass fittings for cold and hot water installation, heating installation  $\leq 110^{\circ}\text{C}$  (230°F).

In accordance with DVGW work sheet GW 2.

Alloy (weight %)	97 % Sn, 3 % Cu
Melting temperature	230 – 250°C (450 – 480°F)

## REMS Lot Cu 3 – quality soft solder.

Lead-free, harmless to health and environment.  
Silver-free, complies with standards. Very low price.

### Supply format

**REMS Lot Cu 3.** 250-g spool soft solder wire Sn97Cu3, ISO 9453:2014,  $\varnothing$  3 mm, for soft soldering of copper tubes with copper, red copper cast and brass fittings for cold and hot water installation, heating installation  $\leq 110^{\circ}\text{C}$  (230°F).

	Art.-No.	€
	160200R	51,80



German Quality Product

# REMS Paste Cu 3

Soft solder paste of solder powder Sn97Cu3 according to ISO 9453:2014 and flux 3.1.1.C, EN 29454-1:1994

Soft soldering of copper tubes with copper, red copper cast and brass fittings for cold and hot water installation, heating installation  $\leq 110^{\circ}\text{C}$  (230°F).

In accordance with DVGW work sheet GW 7 (DVGW-Reg.-Nr. DV-0101AT2244)

## REMS Paste Cu 3 – quality soft solder paste.

Lead-free, harmless to health and environment.  
Silver-free, complies with standards. Very low price.

No additional flux consumption, paste contains flux already.  
Thus less danger of corrosion.

No overheating of tube and fitting because the melting of solder and the required temperature for soldering is clearly visible through the change of colour of paste.

High filling level of soldering joint, thereby good stability. Easy cleaning of remnants which are soluble in cold water.

Plastic bottle with brush integrated in cap which cannot get lost.

### Supply format

**REMS Paste Cu 3.** 250-g soft solder paste of solder powder Sn97Cu3 according to ISO 9453:2014 and flux 3.1.1.C, EN 29454-1:1994, for soft soldering of copper tubes with copper, red copper cast and brass fittings for cold and hot water installation, heating installation  $\leq 110^{\circ}\text{C}$  (230°F). DVGW approval mark. In plastic bottle with integrated brush.

	Art.-No.	€
	160210R	39,44



German Quality Product

# REMS Lot P6

Brazing solder ISO 17672-CuP 179

Brazing of copper tubes with copper, red copper cast and brass fittings in cold and hot water installation, gas installation, refrigerating and air conditioning applications.

In accordance with DVGW work sheet GW 2.

Alloy (weight %)	94 % Cu, 6 % P
Melting temperature	710 – 890°C (1310 – 1640°F)

## REMS Lot P6 – quality brazing solder.

Universally applicable for almost all types of joints in copper pipe installations.

Specially useful for capillary brazing joints of copper pipe installations without fittings. Wide melting range due to low phosphor content result in higher toughness of soldering joint.

Silver-free, complies with standards. Very low price.

### Supply format



**REMS Lot P6.** 1 kg brazing solder (rods) ISO 17672-CuP 179,  $\varnothing$  2 mm, for brazing of copper tubes with copper, red copper cast and brass fittings for cold and hot water installation, gas installation, refrigerating and air conditioning applications. In a carton.

	Art.-No.	€
	160220R	61,55





# Freezing

	<b>Pipe freezer CO<sub>2</sub></b>	<b>270</b>
	<b>Electric pipe freezing unit</b>	<b>271</b>

Simple, fast freezing of unemptied pipes with a carbon dioxide coolant. For repair, extensions of piping systems.

Steel, copper, plastic,  
composite pipes

Ø 1/8 – 2"  
Ø 10 – 60 mm

Refrigerant: carbon dioxide.

Refrigerating capacity to –79°C (–110°F).

Non toxic, non flammable.

**REMS Eskimo – freezing instead of draining.**  
**Super fast. Automatic refrigerant feed. High cooling capacity, e.g. 3/4" steel pipe in only 5 min.**  
**Very small, indestructible freeze collars.**

### Refrigerant

Carbon dioxide coolant with high cooling performance up to –79°C. Non toxic. Non flammable. Easy to obtain.

### Design

Tight contact between freeze collars and pipe and direct flow of the refrigerant onto the pipe ensure extremely short freezing times and economic refrigerant consumption. Freezing is possible on one or two sides, with additional T-distributors further freeze collars can also be connected.

### Freeze collars

Easy. Rapid assembly, without special tools. Very small, highly flexible, indestructible freeze collars in cold-resistant thermoplastic elastomer, for operating even in the tightest spots. Clamping screws cannot get lost.

### Handle piece with injector

Ergonomically designed handle pieces in plastic for comfortable operation. Unbreakable brass injector (injection nozzle). Fast and secure connection to freeze collars. No setting, the correct amount of refrigerant is automatically supplied.

### High pressure hoses

Flexible, buckling-resistant and fractureproof high pressure hoses. Extra long for wide work radius. Extendable any time. Turnable hollow cap nut at bottle connector prevents high pressure hoses from tangling.



German Quality Product



### Supply format

**REMS Eskimo Set.** Pipe freezing device for carbon dioxide coolant. For steel, cast iron, lead, copper, plastic pipes Ø 1/8 – 2", Ø 10 – 60 mm. Two freezing jackets each in 10 different sizes for the whole working range, flange connection with T-junction, locking nut, 2 handles with injector, 2 high-pressure hoses. In sturdy carrying case.

	Art.-No.	€
	130002R	596,85

### Accessories

Description	Size	Art.-No.	€	
<b>Freezing jacket</b>	1/8"	10/12 mm	130450	40,38
	1/4"	15 mm	130455	40,38
	3/8"	18 mm	130460	40,38
	1/2"	22 mm	130465	40,38
	3/4"	28 mm	130470	40,38
	1"	35 mm	130475	40,38
	1 1/4"	42 mm	130480	53,77
	1 1/2"		130485	53,77
		54 mm	130490	53,77
		60 mm	130495	53,77
<b>High-pressure hose 2 m</b>		130415	115,22	
<b>T-distributor for further collar</b>		130207	25,43	
<b>Bottle connection with T-distributor</b>		130383	47,13	
<b>Locking nut</b>		130209	6,23	
<b>Double nipple</b>		130208	9,65	
<b>Handle piece with injector</b>		130410	55,43	
<b>Case with inlay</b>		130430R	101,72	



# REMS Frigo 2 F-Zero

Electric pipe freezing unit

Easy, fast freezing of pipes which are not drained.  
Closed refrigerant circuit. Environmentally safe.  
For repair and extension of piping systems.

Steel, copper, plastic,  
composite pipes

Ø 1/8 – 2"  
Ø 10 – 60 mm

**REMS Frigo 2 F-Zero – electrically freezing instead of draining. Super fast up to 2". High cooling capacity, e.g. 3/4" steel pipe in only 9 min\*. Particularly compact, patented deep-freezer heads, for very fast assembly. Temperature display with LCD digital thermometer.**

### System advantage

Only one pipe freezing unit for the complete working range up to 2". One-size freezer heads for the core working range Ø 1/8 – 1" / Ø 15 – 35 mm, no reducing inserts required. Aid the cooling process simply by spraying with water. Always clean freezer heads, no pastes/greases required.

### Closed refrigerant circuit

Electric pipe freezing unit with closed refrigerant circuit. Environmentally safe. Can be used anywhere, also in closed rooms. Refrigerant R-290. High cooling capacity. Ideal also for longer repairs.

### Design

Robust, compact. Very small deep-freezer heads fitted parallel to the pipe leaving refrigerant hoses for working in confined areas and niches also. Single or double freezing possible.

### Cooling aggregate

Very quiet. Cooling aggregate, 430 W, in sturdy sheet metal housing with ventilating side openings for optimum air circulation. Large top compartment, easily accessible, for refrigerant hoses and accessories. Weighs only 23 kg. Easy to carry.

### Deep-freezer heads

Very compact deep-freezer heads with special geometrically shaped cavities for seating different pipe diameters. Very small, only 50 mm wide. All pipe sizes from Ø 1/8 – 1" resp. Ø 15 – 35 mm can be frozen with only one deep-freezer head. Deep-freezer inserts for the rest of the capacity up to 2", 60 mm. Tightening straps for simple and quick assembly of deep-freezer heads onto the pipe, without tools.

### Refrigerant hoses

Flexible, extra-long refrigerant hoses, 2.5 m long, in wear resistant, synthetic rubber for large work radius.

### LCD-Digital-Thermometer

LCD digital thermometer with clip, for exact temperature display directly at the freezing points.



German Quality Product

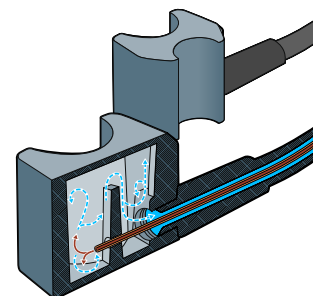

Super fast up to 2"



### Supply format

**REMS Frigo 2 F-Zero Set.** Electric pipe freezing unit with closed refrigerant circuit. For steel, copper, plastic, composite pipes, Ø 1/8 – 2", Ø 10 – 60 mm. Cooling aggregate 230 V or 110 V, 50 Hz, 430 W, 2 refrigerant hoses, 2.5 m long, 2 LCD digital thermometers, 2 tightening straps, squirt bottle. Equipped for Ø 1/8 – 1", 15 – 42 mm. In sturdy sheet metal housing. In a carton.

	Art.-No.	€
	131012R220	1.858,02

### Accessories

Description	Size	Art.-No.	€
<b>Extension kit up to 2", 60 mm</b>	1 1/2 – 2" / 54 – 60 mm	131160R	<b>258,46</b>
<b>Deep-freeze inserts (pack of 2)</b>	1/8" 10, 12 mm	131110R	<b>93,63</b>
	1/2" 54 mm	131156R	<b>86,47</b>
	1" 54 mm	131157R	<b>86,47</b>
	2" 60 mm	131158R	<b>86,47</b>
<b>Clamping band</b>		131104R	<b>15,26</b>
<b>LCD digital thermometer</b>		131116R	<b>38,30</b>







# Pipe and Drain inspection

## Pipe and Drain cleaning

	<b>Endoscope cameras</b>	<b>274</b>
	<b>Electronic camera inspection systems</b>	<b>276</b>
	<b>Drain cleaner for manual and electric operation</b>	<b>282</b>
	<b>Electric drain cleaning machine</b>	<b>283</b>
	<b>Cordless drain cleaning machine</b>	<b>284</b>
	<b>Electric pipe and drain cleaning machines</b>	<b>286</b>

Mobile, handy endoscope camera for low-cost inspection and damage analysis of places with difficult access such as cavities, shafts, pipes, etc. For cordless operation.

Camera head Ø 8 mm

### REMS MiniScope – Brilliant pictures of cavities, shafts and pipes.

#### Design

Ultra light and handy. Controller unit with camera cable set only 0.4 kg. Can be used everywhere, free hand, over head, also in very confined spaces. Sturdy, impact-proof plastic housing with ergonomically shaped handle. The buttons are located directly underneath the display so that it is possible to hold the device by the handle and operate the buttons with one hand. On/Off button, button for rotating, mirroring of the image by 180° respectively, button for regulating the brightness of the LEDs in the camera head in 8 stages, button for regulating the brightness of the colour display in 8 stages. Power LED for indicating the operating state. Battery compartment for 4 commercially available 1.5V, AA, LR6 batteries. Plug-screw connections for changing the camera cable set without tools. Sturdy case for controller unit, camera cable set 8-1 and accessories.

#### Controller unit with TFT-LCD colour display

Controller unit with 2.3" colour display with state of the art TFT-LCD technology for brilliant pictures, 320 × 240 pixels.

#### Battery operation

Controller unit with four 1.5V, AA, LR6 batteries for approx. 6 hours of continuous operation.

#### Exchangeable camera cable set Color

Camera cable set Color 8-1, consisting of colour camera Ø 8 mm (640 × 480 pixels), with CMOS sensor, with dimmable white light LEDs for optimum setting of the brightness and fixed focus function, for automatic picture focus, protected against occasional immersion in water (IP 67), 1 m flexible push cable and add-on mirror, add-on hook, add-on magnet.



Info

### Supply format

**REMS MiniScope Set.** Mobile, handy endoscope camera for low cost inspection and damage analysis of places with difficult access such as cavities, shafts, pipes etc. Controller unit with 2.3" TFT-LCD colour display. 4 batteries 1.5 V, AA, LR6. Camera cable set Color 8-1 with 1 m flexible push cable and add-on mirror, add-on hook, add-on magnet. In sturdy case.

	Art.-No.	€
	175401R6	133,90



# REMS CamScope HD

Endoscope camera

Mobile, handy endoscope camera for low-cost inspection and damage analysis of places with difficult access such as cavities, shafts, pipes, etc. Documentation of photos and videos on MicroSD card. For battery and mains operation.

Camera head Ø 8 mm

## REMS CamScope HD – Brilliant pictures and videos of cavities, shafts and pipes in HD quality (1920 × 1080 pixels). MicroSD card slot.

### Design

Ultra light and handy. Controller unit with pistol grip and camera cable set only 0.5 kg. Can be used everywhere, free hand, over head, also in very confined spaces. Sturdy, impact-proof plastic housing with ergonomically shaped handle. The buttons are located directly underneath the display so that it is possible to hold the device by the pistol grip and operate the buttons with one hand. Bottoms, among other things, for regulating the brightness of the LEDs in the camera head and the display in 4 stages each, for rotating, mirroring and zooming the image shown in the display, calling and navigating in the menu. Power LED for indicating the operating state integrated into the On-Off button. Li-Ion 3.7 V battery with 4.0 Ah for long service life. Different HD camera cable sets can be used. Plug-screw connections for changing the camera cable sets without tools. Sturdy case of controller unit with pistol grip, camera cable set Color 8-1 HD 180°/90°, USB cable and accessories.

### Controller unit with TFT-LCD colour display

Controller unit with pistol grip with 5" colour display with state-of-the-art TFT-LCD technology and 480 × 854 pixels, for brilliant pictures and videos. Selectable menu language. MicroSD card slot. Pictures and videos in HD quality can be saved on a MicroSD card for simple documentation of the inspection result. 4x digital zoom. The date and time of the recording can be saved in the photo and video as an option. Immediate playback of saved recordings or transmission to other devices via MicroSD card. USB port for direct connection to a PC or laptop and for charging the battery.

### Cordless and mains operation

Li-Ion technology. Controller unit with pistol grip with integrated 3.7 V, 4.0 Ah Li-Ion battery. Light and powerful. High energy density for approx. 5 hours continuous operation. The unit can be used in mains mode whilst charging the battery with the USB cable. No memory effect for maximum battery performance.

### Exchangeable camera cable set Color

Consisting of colour camera Ø 8 mm, with CMOS sensor, with dimmable white light LEDs for optimum setting of the brightness and fixed focus function, for automatic picture focus, protected against occasional immersion in water (IP 67).

**Camera cable set Color 8-1 HD 180°/90°** with 180° straight and 90° angled colour camera, with 1 m flexible push cable and add-on hook, add-on magnet. Images and videos can be viewed and recorded from the selected colour camera or from both colour cameras simultaneously.

**Camera cable set Color 8-5 HD** with 5 m flexible push cable as an accessory.

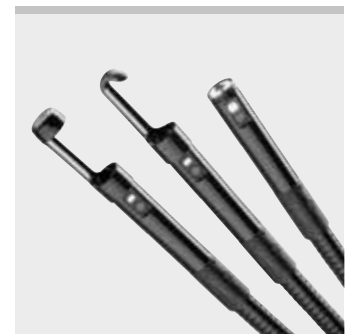

Info

## Supply format

**REMS CamScope HD Set.** Mobile, handy endoscope camera for low cost inspection and damage analysis of places with difficult access such as cavities, shafts, pipes etc. Documentation of pictures and videos in HD quality on MicroSD card. Endoscope camera with 5" TFT-LCD colour display, 4x digital zoom, MicroSD card slot, USB port, integrated 3.7 V, 4.0 Ah Li-ion battery. Camera cable set Color 8-1 HD 180°/90°, 180° straight colour camera and 90° angled colour camera, with 1 m flexible push cable and add-on hook, add-on magnet. 32 GB MicroSD card. USB cable. In sturdy case.

	Art.-No.	€
	175400R4	237,70

## Accessories

Description	Art.-No.	€
<b>Camera cable set Color 8-5 HD</b> , colour camera Ø 8 mm, 1280 × 720 pixels, with 5 m formable push cable	175440R	92,38



Mobile, handy camera inspection system for inexpensive inspection and damage analysis of pipes, drains, chimneys and other hollow cavities. With electronic metering. Also for inspection after pipe cleaning work and for acceptance of new installations or repairs. Documentation of pictures and videos on SD card. For battery and corded operation.

Camera head	Ø 25 mm
Pipe	Ø (40) 50–150 mm
Drains, chimneys, other cavities	

**REMS CamSys – Brilliant pictures and videos of pipes and drains. SD card slot. Electronic metering. Cordless and mains operation.**

**System advantage**

Only **one** controller unit with TFT-LCD colour display for connecting different camera cable sets for different requirements. Therefore inexpensive conversion possible.

**Design**

Mobile, handy, light. Can be used everywhere, even in very narrow places. Controller unit connected to the camera cable set by a 2 m connecting cable, removable for easy cleaning of the camera cable set. Various camera cable sets can be used. Plug-screw connections for changing the camera cable sets and the controller unit without tools. Sturdy case for controller unit, voltage supply/charger and accessories.

**Controller unit with TFT-LCD colour display**

Controller unit with 3.5" colour display with state of the art TFT-LCD technology for brilliant pictures and videos, 89 mm screen diagonal, 320 x 240 pixels. Very light and handy, only 0.4 kg. Sturdy, impact-proof plastic housing, spray protected. Small dimensions: 172 x 121 x 58 mm. Keys for setting the brightness of the LEDs of the colour camera head. Full screen, 2x zoom, 4x rotation options for the picture. SD card slot. Pictures and videos can be saved on an SD card for simple documentation of the inspection result. Insertion depth of the camera is stored in the picture and the video, optionally also date and time of the recording. Pictures can be taken during video recording without impairing the video recording. Immediate playback of saved recordings or transmission to other devices with SD card. Pictures can also be taken later from the video during playback of recorded videos on the controller's colour display. USB connector for direct connection to PC or laptop. Video output socket Composite-Video PAL/NTSC for connecting an external monitor. Connection for voltage supply/charger Li-Polymer 100–240 V.

**Cordless and mains operation**

Li-Polymer Technology. Controller unit with integrated Li-Polymer battery 3.7V, 4.0 Ah. Light and powerful. Power supply/charger 100–240 V, 15 W, with USB port and USB cable for connecting power supply/charger, laptop or other voltage supply. No memory effect for maximum battery performance.

**High resolution special colour camera**

High resolution special colour camera Ø 25 mm with CMOS image sensor and 8 ultra bright, white LEDs with adjustable light intensity up to 1700 mcd and concentrated radiation angle for brilliant colour pictures with even illumination. Low light requirement due to very high light sensitivity (0.1 lux). Fixed focus and special lens with 90° wide angle, also for detecting the smallest details.

**Exchangeable cable camera sets**

Camera cable sets S-Color, consisting of special high-resolution colour camera with optional **30 m push cable Ø 5.4 mm**, flexible, for Ø 50–150 mm, in hasp with electronic metre counter, **20 m push cable Ø 4.5 mm**, very flexible, for small pipe diameters and narrower bends Ø (40) 50–150 mm, in the hasp with electronic metre counter or **10 m push cable Ø 4.5 mm** with length mark, very flexible, for small pipe diameters and narrower pipe bends Ø (40) 50–150 mm, in the cable reel, with connection for controller unit. Very small, rounded camera head Ø 25 mm, water-tight up to 20 m (0.2 MPa/2 bar/29 psi) and highly flexible sliding spring tapered towards the push cable for effortless feeding even through several pipe bends. Camera head with strong, quick-change protective cap with inserted mineral glass pane. Bend-manoeuvring push cable in hybrid technology, with glass fibre core, data cables and plastic sheath, very stable, for long life. Robust, powder-coated, easy to clean cable cage. Hasp with rotary cage for simple unwinding and winding of the push cable and integrated sensor for electronic metering. Carrying case for camera cable set as an accessory.

**Guide bodies**

Various guide bodies for larger pipe diameters, firmly lockable on the camera head, as an accessory.



Info

## Supply format

**REMS CamSys Set S-Color.** Electronic camera inspection system for low-cost inspection and damage analysis. Documentation of pictures and videos on SD card with specification of date and time. Controller unit in microprocessor technology with 3.5" TFT-LCD colour display, SD card slot, USB port, video out socket PAL/NTSC, integrated Li-Polymer battery, 3.7 V, 4.0 Ah, in sturdy, impact-proof plastic housing, spray protected. 2 m connecting cable from the controller unit to the camera cable set, voltage supply/charger 100–240 V, 50–60 Hz, 15 W, SD card 4 GB, USB cable, in sturdy case. Camera cable set S-Color with high resolution special colour camera Ø 25 mm with CMOS image sensor and push cable.

Description	Version	Art.-No.	€
<b>Set S-Color 10 K</b>	10 m push cable Ø 4.5 mm with length mark, very flexible, in cable reel. For small pipe diameters and narrower pipe bends Ø (40) 50–150 mm, drains, shafts, stacks and other cavities.	175008R220	<b>2.491,20</b>
<b>Set S-Color 20 H</b>	20 m push cable Ø 4.5 mm, very flexible, in the hasp with electronic metre counter. For small pipe diameters and narrower pipe bends Ø (40) 50–150 mm, drains, shafts, stacks and other cavities.	175007R220	<b>3.456,54</b>
<b>Set S-Color 30 H</b>	30 m push cable Ø 5.4 mm, flexible, in the hasp with electronic metre counter. For pipes Ø 50–150 mm, drains, shafts, stacks and other cavities.	175010R220	<b>3.559,30</b>



## Accessories

Description	Art.-No.	€
<b>REMS CamSys Basic-Pack.</b> Controller unit in microprocessor technology with 3.5" TFT-LCD colour display, SD card slot, USB port, video out socket PAL/NTSC, integrated Li-Polymer battery, 3.7 V, 4.0 Ah, in sturdy, impact-proof plastic housing, spray protected. 2 m connecting cable from the controller unit to the camera cable set, voltage supply/charger 100–240 V, 50–60 Hz, 15 W, SD card 4 GB, USB cable, in sturdy case.	175000R220	<b>1.401,30</b>
<b>Camera cable set S-Color 10 K</b> with high resolution special colour camera Ø 25 mm with CMOS image sensor, 10 m push cable Ø 4.5 mm with length marking, very flexible, with connection for controller unit, in cable reel. For small diameters and narrower pipe bends Ø (40) 50–150 mm.	175305R	<b>1.089,90</b>
<b>Camera cable set S-Color 20 H</b> with high resolution special colour camera Ø 25 mm with CMOS image sensor and 20 m push cable Ø 4.5 mm, flexible, in the hasp with electronic metering and connection for controller unit. For small diameters and narrower pipe bends Ø (40) 50–150 mm.	175306R	<b>2.055,24</b>
<b>Camera cable set S-Color 30 H</b> with high resolution special colour camera Ø 25 mm with CMOS image sensor and 30 m push cable Ø 5.4 mm, flexible, in the hasp with electronic metering and connection for controller unit. For Ø 50–150 mm.	175011R	<b>2.158,00</b>
<b>Guide body Ø 62 mm S-Color/S-Color S,</b> for camera cable set S-Color/S-Color S	175057R	<b>107,33</b>
<b>Guide body Ø 100 mm S-Color/S-Color S,</b> for camera cable set S-Color/S-Color S	175058R	<b>124,35</b>
<b>Protective cap S-Color/S-Color S</b> with mineral glass pane, sealing ring, for camera cable set S-Color/S-Color S	175026R	<b>36,33</b>
<b>Carrying case</b> for camera cable set	175123R	<b>128,71</b>
<b>Case with inlay</b>	175018R	<b>98,61</b>



Mobile, handy camera inspection system for inexpensive inspection and damage analysis of pipes, drains, chimneys and other hollow cavities. Self-levelling camera. Transmitter for localising camera heads. Electronic metering. Also for inspection after pipe cleaning work and for acceptance of new installations or repairs. Documentation of pictures and videos with voice recording on SD card. For battery and corded operation.

Camera head S-Color/S-Color S	Ø 25 mm
Camera head S-Color S-N	Ø 33 mm
Pipes, drains, chimneys, other cavities	
Camera head S-Color	Ø (40) 50 – 150 mm
Camera head S-Color S	Ø 50 – 150 mm
Camera head S-Color S-N	Ø 70 – 150 mm

**REMS CamSys 2 – Brilliant pictures and videos of pipes and drains. Voice recording Self-levelling camera. Transmitter for localising camera heads. SD card slot. Electronic metering. Cordless and mains operation.**

**System advantage**

Only **one** controller unit with TFT-LCD colour display for connecting different camera cable sets for different requirements. Therefore inexpensive conversion possible.

**Design**

Mobile, handy, light. Can be used everywhere, even in very narrow places. Controller unit connected to the camera cable set by a 2 m connecting cable, removable for easy cleaning of the camera cable set. Various camera cable sets can be used. Plug-screw connections for changing the camera cable sets and the controller unit without tools. Sturdy case for controller unit, voltage supply/charger and accessories.

**Controller unit with TFT-LCD colour display**

Controller unit with 7" colour display with state of the art TFT-LCD technology for brilliant pictures and videos, 178 mm screen diagonal, 720 x 480 pixels. Very light and handy, only 1.3 kg. Sturdy, impact-proof plastic housing, spray protected, glare protection. Integrated stand for different angles of inclination of the screen. Ergonomic grips with soft-grip and adjustable clamping bands, keys for picture and video, for one-hand operation by right and left handers. Small dimensions: 270 x 164 x 70 mm. Keys for setting the brightness of the LEDs of the colour camera head. Full screen, 2x zoom, 4x rotation options for the picture. Adjustable automatic switch-off. SD card slot. Pictures and videos with voice recording can be saved on an SD card for simple documentation of the inspection result. Insertion depth of the camera is stored in the picture and the video, optionally also date and time of the recording. Pictures can be taken during video recording without impairing the video recording. Immediate playback of saved recordings or transmission to other devices with SD card. Pictures can also be taken later from the video during playback of recorded videos on the controller's colour display. USB connector for direct connection to PC or laptop. Video output socket Composite-Video PAL/NTSC for connecting an external monitor. Connection for voltage supply/charger 100 – 240 V.

**Cordless and mains operation**

Li-Polymer Technology. Controller unit with integrated Li-Polymer battery 3.7V, 7.6 Ah. Light and powerful. Power supply/charger 100 – 240 V, 15 W, with USB port and USB cable for connecting power supply/charger, laptop or other voltage supply. No memory effect for maximum battery performance.

**High resolution special colour camera**

High resolution special colour camera with CMOS image sensor and ultra bright, white light emitting diodes (LEDs) with adjustable light intensity up to 1700 mcd and concentrated radiation angle for brilliant colour pictures with evenly bright illumination. Low light requirement due to very high light sensitivity (0.1 lux). Fixed focus and special lens with 90° wide angle, also for detecting the smallest details.



Info

## Exchangeable cable camera sets

**Camera cable set S-Color**, consisting of a special high resolution colour camera Ø 25 mm with 20 m push cable Ø 4.5 mm, very flexible, for small pipe diameters and narrower bends Ø (40) 50–150 mm, in the hasp with electronic metering or 10 m push cable Ø 4.5 mm with length mark, very flexible, for small pipe diameters and narrower pipe bends Ø (40) 50–150 mm, in the cable reel. **Camera cable set S-Color S**, consisting of a special high resolution colour camera Ø 25 mm with 30 m push cable Ø 5.4 mm, flexible, for Ø 50–150 mm, in the hasp with electronic metering and 33 kHz transmitter for localising the camera head. **Camera cable set S-Color S-N**, consisting of a special high resolution colour camera Ø 33 mm with 30 m push cable Ø 5.4 mm, flexible, for Ø 70–150 mm, in the hasp with electronic metering, 33 kHz transmitter for localising the camera head and self-levelling camera for upright pictures and videos. Connection for controller unit. Very small, rounded camera head, water-proof up to 20 m (0.2 MPa/2 bar/29 psi) and highly flexible sliding spring tapered towards the push cable for effortless feeding even through several pipe bends. Camera head with strong, quick-change protective cap with inserted mineral glass pane. Bend-manoeuving push cable in hybrid technology, with glass fibre core, data cables and plastic sheath, very stable, for long life. Robust, powder-coated, easy to clean cable cage. Hasp with rotary cage for simple unwinding and winding of the push cable and integrated sensor for electronic metering. Carrying case for camera cable set as an accessory.

## Guide bodies

Guide body S-Color/S-Color S and S-Color S-N Ø 62 mm and Ø 100 mm, for greater pipe diameters, can be locked to camera head S-Color/S-Color S or S-Color S-N, as an accessory.

## Tracker

REMS Explorer for localising a camera head with a 33 kHz transmitter, for determining the position of damages or the course of a pipe, as an accessory.



## Supply format

**REMS CamSys 2 Set S-Color.** Electronic camera inspection system for low-cost inspection and damage analysis. Documentation of pictures and videos with voice recording on SD card with specification of date and time. Controller unit in microprocessor technology with 7" TFT-LCD colour display, SD card slot, USB port, video out socket PAL/NTSC, integrated Li-Polymer battery 3.7V, 7.6 Ah, in sturdy, impact-proof plastic housing, spray protected, glare protection, stand. 2 m connecting cable from the controller unit to the camera cable set, voltage supply/charger 100–240V, 50–60 Hz, 15 W, SD card 4 GB, USB cable, video cable, in sturdy case. Camera cable set S-Color with high resolution special colour camera with CMOS image sensor and push cable.

Description	Version	Art.-No.	€
<b>Set S-Color 10 K</b>	High resolution special colour camera Ø 25 mm, 10 m push cable Ø 4.5 mm with length mark, very flexible, in the cable reel. For small pipe diameters and narrower pipe bends Ø (40) 50–150 mm, drains, shafts, stacks and other cavities.	175301R220	<b>3.051,72</b>
<b>Set S-Color 20 H</b>	High resolution special colour camera Ø 25 mm, 20 m push cable Ø 4.5 mm, very flexible, in the hasp with electronic metering. For small pipe diameters and narrower pipe bends Ø (40) 50–150 mm, drains, shafts, stacks and other cavities.	175302R220	<b>4.017,06</b>
<b>Set S-Color S 30 H</b>	High resolution special colour camera Ø 25 mm, 33 kHz transmitter for localising the camera head, 30 m push cable Ø 5.4 mm, flexible, in the hasp with electronic metering. For pipes Ø 50–150 mm, drains, shafts, stacks and other cavities.	175303R220	<b>4.224,66</b>
<b>Set S-Color S-N 30 H</b>	High resolution special colour camera Ø 33 mm, self-levelling, 33 kHz transmitter for localising the camera head, 30 m push cable Ø 5.4 mm, flexible, in the hasp with electronic metering. For pipes Ø 70–150 mm, drains, shafts, stacks and other cavities.	175304R220	<b>4.587,96</b>



Description	Art.-No.	€
<b>REMS CamSys 2 Basic-Pack</b> Controller unit in microprocessor technology with 7" TFT-LCD colour display, SD card slot, USB port, video out socket PAL/NTSC, integrated Li-Polymer battery, 3.7 V, 7.6 Ah, in sturdy, impact-proof plastic housing, glare protection, stand, spray protected. 2 m connecting cable from the controller unit to the camera cable set, voltage supply/charger 100–240 V, 50–60 Hz, 15 W, SD card 4 GB, USB cable, video cable, in sturdy case.	175300R220	<b>1.961,82</b>
<b>Camera cable set S-Color 10 K</b> High resolution special colour camera Ø 25 mm, 10 m push cable Ø 4.5 mm with length mark, very flexible, in the cable reel. For small diameters and narrower pipe bends Ø (40) 50–150 mm.	175305R	<b>1.089,90</b>
<b>Camera cable set S-Color 20 H</b> High resolution special colour camera Ø 25 mm, 20 m push cable Ø 4.5 mm, very flexible, in the hasp with electronic metering. For small diameters and narrower pipe bends Ø (40) 50–150 mm.	175306R	<b>2.055,24</b>
<b>Camera cable set S-Color S 30 H</b> High resolution special colour camera Ø 25 mm, 33 kHz transmitter for localising the camera head, 30 m push cable Ø 5.4 mm, flexible, in the hasp with electronic metering. For Ø 50–150 mm.	175307R	<b>2.262,84</b>
<b>Camera cable set S-Color S-N 30 H</b> High resolution special colour camera Ø 33 mm, self-levelling, 33 kHz transmitter for localising the camera head, 30 m push cable Ø 5.4 mm, flexible, in the hasp with electronic metering. For Ø 70–150 mm.	175308R	<b>2.626,14</b>
<b>Guide body Ø 62 mm S-Color/S-Color S,</b> for camera head S-Color/S-Color S	175057R	<b>107,33</b>
<b>Guide body Ø 100 mm S-Color/S-Color S,</b> for camera head S-Color/S-Color S	175058R	<b>124,35</b>
<b>Guide body Ø 62 mm S-Color S-N,</b> for camera head S-Color S-N	175343R	<b>59,48</b>
<b>Guide body Ø 100 mm S-Color S-N,</b> for camera head S-Color S-N	175339R	<b>83,46</b>
<b>Protective cap S-Color/S-Color S</b> with mineral glass pane, sealing ring, for camera head S-Color/S-Color S	175026R	<b>36,33</b>
<b>Protective cap S-Color S-N</b> with mineral glass pane, sealing ring, for camera head S-Color S-N	175330R	<b>86,05</b>
<b>REMS Explorer,</b> tracker for localising a camera head with a 33 kHz transmitter	175312R	<b>1.987,77</b>
<b>Carrying case</b> for camera cable set	175123R	<b>128,71</b>
<b>Case with inlay</b>	175323R	<b>98,61</b>







**REMS**  
Explorer

**REMS CamSys2**

**REMS CamSys2**

# REMS Pull-Push

Suction and pressure cleaning device

Proven, reliable suction and pressure cleaning device for fast clearance of blockages.

## REMS Pull-Push – fast clearance of blockages.

High pressing force by front, adjustable handle.

Optimum adaptation to the cleaning task by 2 sleeves:

Short sleeve for wash basins and baths, long sleeve for toilets.



Info



### Supply format

**REMS Pull-Push.** Suction and pressure cleaning device for fast clearance of blockages. With short and long sleeve. In a box.

	Art.-No.	€
	170300R	133,90

# REMS Mini-Cobra

Drain cleaner for manual and electric operation

Proven, handy device for the fast unblocking of pipes, e.g. for kitchens, bathrooms and toilets.

For pipes  $\varnothing$  20 – 50 (75) mm

For drain cleaning cables  $\varnothing$  6, 8, 10 mm

## REMS Mini-Cobra – by hand or electric. Indispensable to remove small blockages.

### Design

Simple, robust, practical design. Handy, light. Only 2.9 kg. Easy operation also in traps and tight bends. Easy insertion of cable directly through strainers in sinks and drains. Locking of cable by quick-action chuck.

### Drain cleaning cables

Cables in high quality spring steel. Specially hardened. Highly flexible for effortless feed-forward in tight bends. Cable end with bulbous head (sink strainer head), thus easy to bend.

### Cable drum

In hot-galvanized spring steel. Specially hardened. Highly flexible for effortless feed-forward in tight pipe bends. Cable end with bulbous head. Corrosion-resistant cable drum in shock-proof, glass-fibre reinforced plastic prevents pollution of the environment. Ventilation of the cable drum interior enables self-drying of cable. View to cable at all times.

### Drive

By hand with easy action, easy grip crank handle or with suitable electric drill/ with suitable electric screwdriver, speed  $\leq$  300 rpm. Hexagon adapter for electric drive located in the drum cover.



German Quality Product



Info



### Supply format

**REMS Mini-Cobra.** Pipe cleaning device for pipes  $\varnothing$  20 – 50 (75) mm, with crank handle and hexagonal driver for electric drill/screwdriver. For drain cleaning cables  $\varnothing$  6, 8 and 10 mm. Cable drum in shock-proof, glass-fibre reinforced plastic. Quick-action chuck. Cable  $\varnothing$  8 mm  $\times$  7.5 m long. In a carton.

	Art.-No.	€
	170010R	185,80

### Accessories

Description	$\varnothing$ $\times$ Length	Art.-No.	€
<b>Drain cleaning cable</b>	8 mm $\times$ 7.5 m	170200	69,03
	10 mm $\times$ 10 m	170205	140,03
<b>Drain cleaning cable with core</b>	8 mm $\times$ 7.5 m	170201	98,40
<b>L-Boxx H system case with inserts</b>		170118R	146,36



# REMS Mini-Cobra S

Electric drain cleaning machine

Electric pipe cleaning device with fast switchover. For effortless and quick application to remove pipe blockages in kitchen, bath, toilet.

For pipes  $\varnothing$  20 – 50 (75) mm  
For drain cleaning cables  $\varnothing$  8, 10 mm

**REMS Mini-Cobra S – Fast clearance of pipe blockages. Ultra fast reversal of direction of spiral feed/return by fast switchover.**

## Design

Compact unit of drive machine and cable drum. Handy, light. Only 5.7 kg. Combined thrust and grip handle for controlling the automatic feed-forward and reverse and for safe holding of the unit. Easy operation also in traps and tight bends.

## Fast switchover

For easy operation and fast clearance of pipe blockages. Ultra fast reversal of direction of spiral feed/return by fast switchover (**Patent EP 3 059 022**) also under full load without changing the motor's direction of rotation, avoids looping of the drain cleaning cables when suddenly encountering resistance from pipe blockages, for long life of the drain cleaning cables.

## Drain cleaning cables

Drain cleaning cables in high quality spring steel. Specially hardened. Highly flexible for effortless feed-forward in tight pipe bends. Cable end with bulbous head (sink strainer head), thus easy to bend. Drain cleaning cables with core in high quality spring steel prevents ingress of dirt and generation of long fibres in the cable windings.

## Cable drum

Corrosion resistant cable drum in shock-proof, glass-fibre reinforced plastic prevents pollution of the environment. Ventilation of the cable drum interior enables self-drying of cable. View of the cable at any time.

## Drive

Proven drive unit with hexagon mount. Enormously powerful. Robust, maintenance-free gear with safety slipping clutch. Universal motor, 630 W, high-torque forward and reverse at low speed. Stepless, electronic speed control. The speed between 0 and 950 rpm is controlled by pressing the tip switch steplessly (acceleration switch).



German Quality Product



Info



Patent EP 3 059 022

## Supply format

**REMS Mini-Cobra S.** Electric pipe cleaning device with fast switchover, for pipes  $\varnothing$  20 – 50 (75) mm. For drain cleaning cables  $\varnothing$  8 and 10 mm. Drive unit with maintenance-free gear, universal motor 230 V or 110 V, 50 – 60 Hz, 630 W, high-torque forward and reverse at low speed. Safety tip switch. Stepless, electronic speed control (acceleration switch) between 0 and 950 rpm. Cable drum in shock-proof, glass-fibre reinforced plastic. Cable  $\varnothing$  8 mm, with core, 7.5 m long.

Description	Art.-No.	€
<b>REMS Mini-Cobra S</b> , in a carton	170022R220	<b>559,48</b>
<b>REMS Mini-Cobra S Set</b> , in sturdy steel case.	170023R220	<b>663,28</b>



## Accessories

Description	$\varnothing$ × Length	Art.-No.	€
<b>Drain cleaning cable with core</b>	8 mm × 7.5 m	170201	<b>98,40</b>
<b>Drain cleaning cable</b>	10 mm × 10 m	170205	<b>140,03</b>
<b>Steel case</b>		185058R	<b>110,03</b>



Mobile, handy, cordless pipe cleaning device with fast switchover. For effortless and quick application to remove pipe blockages in kitchen, bath, toilet. Li-Ion 22V Technology. For battery and corded operation.

For pipes	Ø 20 – 50 (75) mm
For drain cleaning cables	Ø 8, 10 mm

**REMS Mini-Cobra S 22V VE – fast clearance of pipe blockages anywhere. Ultra fast reversal of direction of spiral feed/return by fast switchover. With powerful, brushless battery motor.**

### Design

Compact unit of cordless drive unit and spiral drum. Mobile, handy, light. Complete with battery pack only 5.2 kg. Combined thrust and grip handle for controlling the automatic feed-forward and reverse and for safe holding of the unit. Easy operation also in traps and tight bends. Integrated LED work light for illuminating the work place.

### Fast switchover

For easy operation and fast clearance of pipe blockages. Ultra fast reversal of direction of spiral feed/return by fast switchover (**Patent EP 3 059 022**) also under full load without changing the motor's direction of rotation, avoids looping of the drain cleaning cables when suddenly encountering resistance from pipe blockages, for long life of the drain cleaning cables.

### Drain cleaning cables

Drain cleaning cables in high quality spring steel. Specially hardened. Highly flexible for effortless feed-forward in tight pipe bends. Cable end with bulbous head (sink strainer head), thus easy to bend. Drain cleaning cables with core in high quality spring steel prevents ingress of dirt and generation of long fibres in the cable windings.

### Cable drum

Corrosion resistant cable drum in shock-proof, glass-fibre reinforced plastic prevents pollution of the environment. Ventilation of the cable drum interior enables self-drying of cable. View of the cable at any time.

### Drive

High-performance electro-mechanical drive with powerful, brushless motor 21.6V, 500 W output, extra torque powerful left and right hand rotation at specially adapted speed, robust, precision ball bearing-mounted gear, maintenance-free. Safety switch, electronically controlled for jolt-free switching on and off. Continuous, electronic speed control. The speed can be continuously controlled by variable pressure on the safety switch from 0 to 560 rpm (accelerator switch /VE).

### Battery or mains operation

Li-Ion 22V Technology. Highly resistant Li-Ion 21.6V battery with 1.5, 4.4, 5.0 or 9.0Ah capacity, for long service life. Light and powerful. Graduated charging status check by coloured LEDs. Operating temperature range – 10 to + 60 °C. No memory effect for maximum battery power. Rapid charger 100–240V, 90W. Rapid charger 100–240V, 290W, for shorter charging times, as accessory. 220–240V/21.6V, 15A output, voltage supply for mains operation instead of Li-Ion battery 21.6V, as accessory.



German Quality Product



Info



Patent EP 3 059 022



## Supply format

**REMS Mini-Cobra S 22 V VE.** Cordless pipe cleaning device with fast switchover, for pipes  $\varnothing$  20–50 (75) mm. For drain cleaning cables  $\varnothing$  8 and 10 mm. Drive unit with powerful, brushless battery motor 21.6 V, 500 W, maintenance-free, robust gear, extra torque powerful left and right hand rotation at low speeds, safety switch. Continuous, electronic speed control (accelerator switch (VE)) from 0 to 560 rpm. Battery Li-Ion 21.6 V, 2.5 Ah, rapid charger 220–240 V, 50–60 Hz, 70 W. Cable drum in shock-proof, glass-fibre reinforced plastic. Cable  $\varnothing$  8 mm, with core, 7.5 m long.

Description	Art.-No.	€
<b>REMS Mini-Cobra S 22 V VE,</b> in a carton	170025R220	<b>767,08</b>
<b>REMS Mini-Cobra S 22 V VE Set,</b> in L-Boxx H system case	170027R220	<b>922,78</b>

Other voltages on request.

## Accessories

Description	$\varnothing$ × Length	Art.-No.	€
<b>Drain cleaning cable with core</b>	8 mm × 7.5 m	170201	<b>98,40</b>
<b>Drain cleaning cable</b>	10 mm × 10 m	170205	<b>140,03</b>
<b>Battery Li-Ion 21.6 V, 2.5 Ah</b>		571571R22	<b>258,46</b>
<b>Battery Li-Ion 21.6 V, 4.4 Ah</b>		571574R22	<b>372,64</b>
<b>Battery Li-Ion 21.6 V, 5.0 Ah</b>		571581R22	<b>310,36</b>
<b>Battery Li-Ion 21.6 V, 9.0 Ah</b>		571583R22	<b>414,16</b>
<b>Rapid charger 100–240 V, 50–60 Hz, 90 W</b>		571585R220	<b>175,42</b>
<b>Rapid charger 100–240 V, 50–60 Hz, 290 W</b>		571587R220	<b>414,16</b>
<b>Voltage supply 220–240 V/21.6 V, 50–60 Hz, 15 A,</b> for mains operation instead of battery Li-Ion 21.6 V.		571567R220	<b>414,16</b>
<b>L-Boxx H system case with inserts</b>		170118R	<b>146,36</b>
<b>REMS Lumen 2800 22V, cordless LED flood light, see page 111</b>			



Handy, robust, compact machines for versatile use in pipe and drain cleaning. High-speed rotator with connectable cable sections. Proven technology.

For pipes	Ø 20 – 250 mm
For pipe and drain cleaning cables	Ø 8, 16, 22, 32 mm

All pipe and drain cleaning cables and tools can also be used for other makes.

### REMS Cobra – clear pipe – easy and fast.

**High-speed rotator with cable sections for work length up to 100 m. Effective chain knocking and milling up to 740 rpm. Closed drive spindle protects motor and drive against dirt and water.**

### High speed rotator with connectable cable sections

High-speed rotator, 740 rpm (REMS Cobra 22) resp. 520 rpm (REMS Cobra 32), with cable sections for effective fast operation, e.g. during chain knocking or milling. Under difficult conditions also, e.g. roots and hard incrustations. Cable sections to be connected as needed up to 70 m (REMS Cobra 22) resp. 100 m (REMS Cobra 32) work length. No unnecessary rotating of long pipe and drain cleaning cables.

### Design

Robust, practical, splash-proof. Maintenance-free. Small in size. Favourable weight, drive unit REMS Cobra 22 only 19 kg, drive unit REMS Cobra 32 only 24 kg. Machine frame made of distortion-free cast aluminium with protective covers in shock-proof plastic material. REMS Cobra 22 with holders for part spirals 16 and 22 for fixing the part spirals to the machine frame when changing spirals. Chucking system which is located outside the machine housing with straight through undivided drive spindle for the pipe and drain cleaning cable. This enables a complete seal of the machine interior against dirt and water. Connecting cable with integrated personal protection switch (PRCD). Guide hose prevents excess rotation of pipe and drain cleaning cables and pollution of the environment. Legs with rubber caps guarantee a safe, floor-protecting stand.

### High-performance pipe and drain cleaning cables

Specially hardened. Highly flexible for effortless feed-forward in tight pipe bends. Rapid action coupling for fast extension and shortening. T-groove coupling with safety lock through spring-loaded thrust pin. Manual feed-forward for sensitive operation. Standard pipe and drain cleaning cable for universal pipe and drain cleaning jobs, highly flexible, specially suited for tight or several consecutive pipe bends. Pipe and drain cleaning cable S with thicker special spring steel for very difficult to remove obstructions, e.g. root cutting. Drain cleaning cables with weather-proof and temperature resistant plastic core prevents drain cleaning cable from dirt and generation of long fibres in the cable windings. Drive through REMS Cobra 22, REMS Cobra 32 or drive machines of other makes.

### Clamping jaws for cable drive

Clamping jaws in high-grade hardened steel, resistant to wear and precise fit. Instant and exact clamping and opening of pipe and drain cleaning cables allow optimum control, power transmission and operating safety. REMS Cobra 22: Choice of pipe and drain cleaning cables Ø 16 mm and 22 mm, without changing the clamping jaws. Pipe and drain cleaning cable Ø 8 mm with adapter drum 22/8 and integrated clamping jaws, as accessory. REMS Cobra 32: Choice of drain cleaning cables Ø 22 and 32 mm, without changing the clamping jaws. Drain cleaning cables Ø 16 mm with clamping jaws 16, as accessory. Pipe and drain cleaning cable Ø 8 mm with adapter drum 32/8 and integrated clamping jaws, as accessory.

### Drive

Powerful, quiet running capacitor motor with high torque, 750 W (REMS Cobra 22), 1050 W (REMS Cobra 32), right and left-hand rotation. Full transmission of motor power by a slipping-proof maintenance-free toothed belt drive. Straight through closed drive spindle. Permanently lubricated, maintenance-free roller bearings. Fast and secure run and stop of pipe and drain cleaning cable through strong, centrally located pressing lever provides central power input. Lever doubles as a carrying device without awkward locking.

### Pipe and drain cleaning tools

Large variety of pipe and drain cleaning tools (page 288–289), also fit into pipe and drain cleaning machines of other makes.



German Quality Product

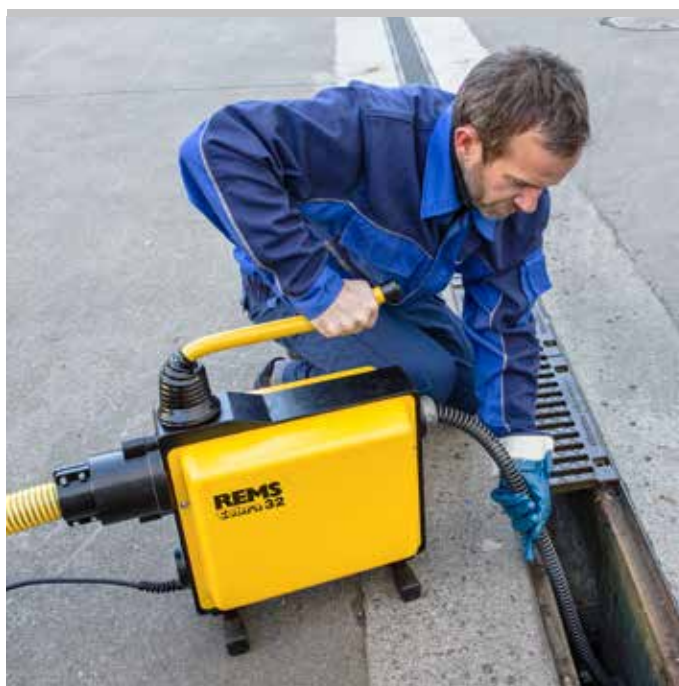

German Quality Product



Straight through closed drive spindle protects motor and drive against dirt and water.

## Supply format

**REMS Cobra 22 Set.** Electric pipe and drain cleaning machine for pipes Ø 20–150 mm. Drive unit with maintenance-free belt drive, capacitor motor 230 V, 50 Hz, 750 W, right and left-hand rotation, guide hose. Personal protection switch (PRCD). Choice of cable and tool set 16 or/and 22. In a carton.

Description	Version	Art.-No.	€
<b>Set 16</b>	5 cable sections 16 × 2.3 m in cable carrier, straight auger 16, bulbous auger 16, toothed blade borer 16/25, cable joint separator, 1 pair of guide gloves, steel case for tool set	172010R220	<b>1.806,12</b>
<b>Set 22</b>	5 cable sections 22 × 4.5 m in cable carrier, straight auger 22, retrieving auger 22, funnel auger 22, toothed cross-blade borer 22/35, cable joint separator 22/32, 1 pair of guide gloves, steel case for tool set	172011R220	<b>1.992,96</b>
<b>Set 16 + 22</b>	5 cable sections 16 × 2.3 m in cable carrier, straight auger 16, bulbous auger 16, toothed blade borer 16/25, cable joint separator, 5 cable sections 22 × 4.5 m in cable carrier, straight auger 22, retrieving auger 22, funnel auger 22, toothed cross-blade borer 22/35, cable joint separator 22/32, 2 pairs of guide gloves, steel case for each tool set	172012R220	<b>2.335,50</b>



Info

## Supply format

**REMS Cobra 32 Set.** Electric pipe and drain cleaning machine for pipes Ø 20–250 mm (½–10"). Drive unit with maintenance-free belt drive, capacitor motor 230 V, 50 Hz, 1050 W, right and left-hand rotation, guide hose. Personal protection switch (PRCD). Choice of cable and tool set 32 or cable and tool sets 22 and 32 or 16 and 22. In a carton.

Description	Version	Art.-No.	€
<b>Set 32</b>	4 cable sections 32 × 4.5 m in cable carrier, straight auger 32, retrieving auger 32, funnel auger 32, toothed cross-blade borer 32/45, cable joint separator 22/32, 1 pair of guide gloves, case for tool set	174010R220	<b>3.923,64</b>
<b>Set 22 + 32</b>	5 cable sections 22 × 4.5 m in cable carrier, straight auger 22, retrieving auger 22, funnel auger 22, toothed cross-blade borer 22/35, cable joint separator 22/32, 4 cable sections 32 × 4.5 m in cable carrier, straight-auger 32, retrieving auger 32, funnel-auger 32, toothed cross-blade borer 32/45, cable joint separator 22/32.2 pairs of guide gloves, steel case/case for each tool set	174011R220	<b>4.619,10</b>
<b>Set 16 + 22</b>	5 cable sections 16 × 2.3 m in cable carrier, 2 clamping jaws 16, straight auger 16, bulbous auger 16, toothed blade borer 16/25, cable joint separator 16, 5 cable sections 22 × 4.5 m in cable carrier, straight auger 22, retrieving auger 22, funnel auger 22, toothed cross-blade borer 22/35, cable joint separator 22/32, 2 pairs of guide gloves, steel case for each tool set	174012R220	<b>4.224,66</b>



Info

## Accessories

Description	Art.-No.	€
<b>REMS Cobra 22 drive unit</b> with guide hose	172000R220	<b>1.650,42</b>
<b>REMS Cobra 32 drive unit</b> with guide hose	174000R220	<b>3.051,72</b>

**Pipe and drain cleaning tools** see page 288–289.



# REMS Cobra 22/32

Accessories for REMS Cobra 22, REMS Cobra 32  
and other makes

Description	Size	Art.-No.	€
<b>Cable and tool set 16</b> consisting of 5 cable sections 16 × 2.3 m in cable carrier, straight auger 16, bulbous auger 16, toothed blade borer 16/25, cable joint separator, 1 pair of guide gloves, steel case for tool set		172050R	<b>601,00</b>
<b>Cable and tool set 22</b> consisting of 5 cable sections 22 × 4.5 m in cable carrier, straight auger 22, retrieving auger 22, funnel auger 22, toothed cross-blade borer 22/35, cable joint separator, 1 pair of guide gloves, steel case for tool set		172051R	<b>840,78</b>
<b>Cable and tool set 32</b> consisting of 4 cable sections 32 × 4.5 m in cable carrier, straight auger 32, retrieving auger 32, funnel auger 32, toothed cross-blade borer 32/45, cable joint separator 22/32, 1 pair of guide gloves, case for tool set		174050R	<b>1.078,48</b>
<b>Adapter drum REMS Cobra 22/8</b> with cable Ø 8 mm × 7.5 m long, with bulbous head		170011	<b>670,24</b>
<b>Adapter drum REMS Cobra 32/8</b> with cable Ø 8 mm × 7.5 m long, with bulbous head		170012	<b>670,24</b>
<b>Clamping jaws 16 (pack of 2)</b> for REMS Cobra 32 for clamping drain cleaning cables Ø 16 mm		174101	<b>121,13</b>
<b>Pipe and drain cleaning cable</b> for pipe-Ø 10–50 (75) mm	8 × 7.5 m	170200	<b>69,03</b>
for pipe-Ø 25–125 mm	16 × 2.3 m	171200	<b>68,72</b>
for pipe-Ø 50–150 mm	22 × 4.5 m	172200	<b>108,99</b>
for pipe-Ø 50–250 mm	32 × 4.5 m	174200	<b>152,59</b>
<b>Pipe and drain cleaning cable</b> (5 pieces) in cable carrier for pipe-Ø 25–125 mm	16 × 2.3 m	171201	<b>450,18</b>
<b>Pipe and drain cleaning cable</b> (5 pieces) in cable carrier for pipe-Ø 50–150 mm	22 × 4.5 m	172201	<b>576,09</b>
<b>Pipe and drain cleaning cable</b> (4 pieces) in cable carrier for pipe-Ø 50–250 mm	32 × 4.5 m	174201	<b>728,68</b>
<b>Pipe and drain cleaning cable S</b> With thick special spring steel for high stability, e.g. during root cutting, milling, chain knocking for pipe-Ø 25–125 mm	16 × 2 m	171205	<b>87,81</b>
for pipe-Ø 50–150 mm	22 × 4 m	172205	<b>146,36</b>
for pipe-Ø 50–250 mm	32 × 4 m	174205	<b>260,54</b>
<b>Pipe and drain cleaning cable with core</b> prevents clogging of pipe and drain cleaning cable with dirt for pipe-Ø 25–125 mm	16 × 2.3 m	171210	<b>95,18</b>
for pipe-Ø 50–150 mm	22 × 4.5 m	172210	<b>174,38</b>
for pipe-Ø 50–250 mm	32 × 4.5 m	174210	<b>204,49</b>
<b>Pipe and drain cleaning cable with core</b> (5 pieces) in cable carrier for pipe-Ø 50–150 mm	22 × 4.5 m	172203	<b>880,22</b>
<b>Pipe and drain cleaning cable with core</b> (4 pieces) in cable carrier for pipe-Ø 50–250 mm	32 × 4.5 m	174203	<b>936,28</b>
<b>Cable reduction 22/16</b> for connecting individual cables of different sizes	22/16	172154	<b>124,56</b>
<b>Cable reduction 32/22</b> for connecting individual cables of different sizes	32/22	174154	<b>144,28</b>
<b>Cable carrier (empty)</b>	16	171150	<b>106,60</b>
	22	172150	<b>106,91</b>
	32	174150	<b>118,33</b>
<b>Cable joint separator</b> for releasing the safety lock	16	171151	<b>4,15</b>
	22/32	172151	<b>4,67</b>





Description	Size	Art.-No.	€
<b>Straight auger</b> for exploring the obstruction to withdraw a sample. Clearing of solid blockages caused by e.g. textiles, paper, kitchen waste	16 22 32	171250 172250 174250	<b>34,77</b> <b>45,67</b> <b>57,61</b>
<b>Bulbous auger</b> for minor obstructions caused by textiles and papers. Flexible, facilitates advancement in tight bends.	16 22 32	171265 172265 174265	<b>34,77</b> <b>45,78</b> <b>59,79</b>
<b>Funnel auger</b> for textile and paper obstructions in particular. Especially useful for cleaning larger diameter pipes. Also be used as a recovery tool for cables left in the pipe.	16 22 32	171270 172270 174270	<b>38,41</b> <b>49,82</b> <b>67,99</b>
<b>Retrieving auger</b> with extended, specially angled grappling arms. Used to recover cables left in the pipe. Not suitable for boring operations.	16 22 32	171275 172275 174275	<b>34,77</b> <b>48,99</b> <b>58,44</b>
<b>Serrated blade borer</b> for boring out greasy or heavily silted pipes, e.g. drains of washing machines, dishwashers. Riveted to the connector (not soldered or welded), so as to prevent any deformation of the hardened spring steel blades.	16/25 22/35 22/45 32/55	171280 172280 172281 174282	<b>31,87</b> <b>46,81</b> <b>58,85</b> <b>76,71</b>
<b>Serrated cross-blade borer</b> Universal use for obstructions of all kinds, including incrustations, e.g. limescale deposits on the inside of the pipe. Riveted to the connector (not soldered or welded), so as to prevent any deformation of the hardened spring steel blades. Operation with pipe and drain cleaning cable S recommended.	16/25 16/35 22/35 22/45 22/65 32/45 32/65 32/90 32/115	171290 171291 172290 172291 172293 174291 174293 174295 174296	<b>61,45</b> <b>69,23</b> <b>82,42</b> <b>92,59</b> <b>88,96</b> <b>93,11</b> <b>112,10</b> <b>138,05</b> <b>148,43</b>
<b>Forked cutter</b> to remove moderate to severe silting or persistent grease contamination. Made of hardened spring steel.	16	171305	<b>40,79</b>
<b>Cross-forked cutter</b> to remove moderate to severe silting or persistent grease contamination. Made of hardened spring steel. Operation with pipe and drain cleaning cable S recommended.	16	171306	<b>60,41</b>
<b>Serrated forked cutter</b> Versatile use, e.g. for removal of slurries and for mincing (crushing) of root infested pipe. Made of hardened spring steel.	22/65 32/65 32/90	172305 174305 174306	<b>97,99</b> <b>107,95</b> <b>126,64</b>
<b>Root cutter</b> specially designed for root infested pipe. Hardened, replaceable ring-type saw, cutting to front and rear. Operation with pipe and drain cleaning cable S recommended.	22/65 32/65 32/90	172310 174310 174311	<b>145,32</b> <b>160,89</b> <b>183,73</b>
<b>Chain knocker, smooth rings</b> for final pipe and drain cleaning for removal of grease deposits and incrustations, e.g. limescale deposits on the inside of the pipe. For sensitive pipes, e.g. plastic.	16 22 32	171340 172340 174340	<b>115,53</b> <b>151,55</b> <b>183,93</b>
<b>Chain knocker, spiked links</b> for final pipe and drain cleaning for removal of grease deposits and incrustations, e.g. limescale deposits on the inside of the pipe. For cast and concrete pipes.	16 22 32	171341 172341 174341	<b>138,37</b> <b>187,88</b> <b>216,94</b>
<b>Guide gloves, pair</b> for secure gripping and guiding of pipe and drain cleaning cables		172610	<b>24,50</b>
<b>Riveted guide glove, left</b> <b>Riveted guide glove, right</b> for secure gripping and guiding of pipe and drain cleaning cables. Fully leather, inner surface riveted.		172611 172612	<b>51,07</b> <b>51,07</b>



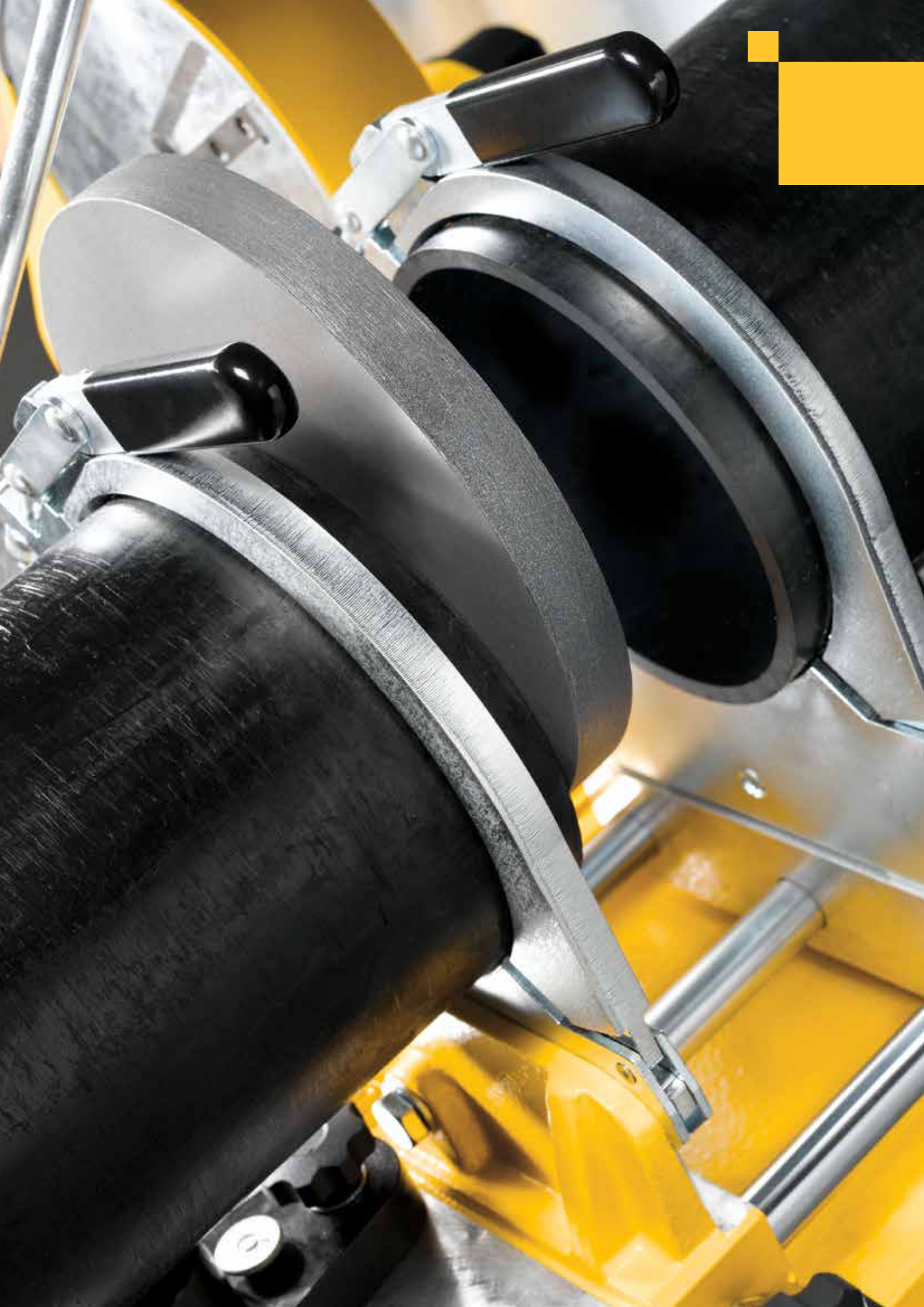

# Plastic Pipe Welding



**Electric sleeve welding unit**

**292**



**Sleeve welding units**

**293**



**Butt welding machines**

**294**



**Butt welding units**

**298**

Powerful, handy unit for welding plastic drain pipes with electric sleeves in PE.

Plastic pipes and electric sleeves in PE Ø 32 – 160 mm

For Geberit, Akatherm-Euro, Coes, Valsir, Waviduo

**REMS EMSG 160-2 – automatic welding. Electronic control. Acoustic and visual monitoring of welding process.**

Smallest sizes. Super-handy, light, only 1.1 kg. Can be used anywhere.

Electronic control with micro controller for automatic adjustment of welding current (welding temperature) and welding time according to sleeve size.

Automatic compensation of welding time in accordance with the ambient temperature.

Acoustic and visual monitoring of welding process.

Angled electrofusion plug for use in very confined spaces.

Wide work radius through extra-long cables.

Sturdy, impact-proof plastic housing with snap hook, for hanging next to the welding point. Dust and splash water-protected.

Manual pipe scraper for treating the surface of the pipe ends to be welded.



Angled electrofusion plug for use in very confined spaces.



Info

**Supply format**

**REMS EMSG 160-2.** Electric sleeve welding unit 230 V, 50–60 Hz, 1000W, for welding plastic drain pipes with electric sleeves in PE made by Akatherm-Euro, Coes, Geberit, Valsir, Waviduo, Ø 32–160 mm. Electronic control, with acoustic and visual monitoring of welding process. In a sturdy, impact-proof plastic housing with snap hook. Welding lead 3.9 m. Manual pipe scraper. In sturdy case.

Art.-No.	€
261002R220	<b>767,08</b>



Powerful electric tools for efficient sleeve welding.  
Can be used anywhere, free-hand or on the work bench.

Plastic pipes and fittings  
in PB, PE, PP, PVDF Ø 16 – 125 mm

### REMS MSG – heating element according to DVS. High quality PTFE coating of heating spigots/sockets.

#### Design

Handy, light, safe. Free-hand or work bench assembly. Supplied in standard with supporting stand and bench support for mounting the unit in a horizontal or vertical position (bench support not supplied for MSG 25).

#### Heating element according to DVS

Plate-shaped, plane parallel heating element according to DVS. Electric heater embedded in corrosion-resistant cast aluminium for indirect heat transfer. Heating spigots and heating sockets according to DVS. High-quality, long-lasting PTFE coating prevents adherence of plastic remnants as well as oxidizing, and enables easy cleaning. Ideal temperature distribution and constant temperature at the complete working area. Fastening screws in stainless steel.

#### Temperature and temperature control

Choice of

- adjustable temperature 180–290°C, preadjusted to 260°C for PP pipes, with electronic temperature control with tight tolerance (EE) or
- Fixed temperature for PP pipes at 263°C, with electronic temperature control with a tolerance of +/- 1% (FE).

The electronic and manual temperature control automatically controls the preadjusted temperature within the permitted range according to DVS. Temperature control lamp and power control lamp.

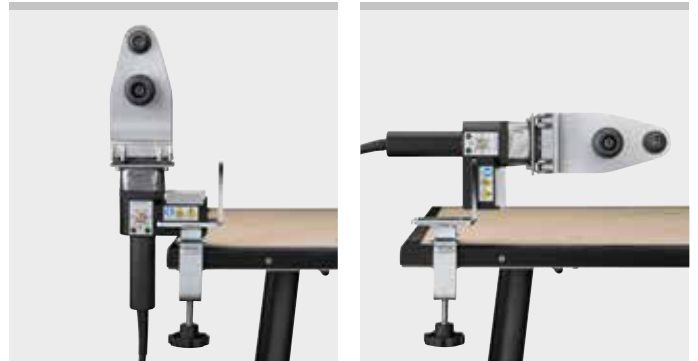

#### Supply format

**REMS MSG.** Sleeve welding unit for plastic pipes and fittings in PB, PE, PP, PVDF. Heating element 230 V, 50–60 Hz, without PTFE-coated heating spigots and heating sockets. Optionally adjustable temperature 180–290°C, pre-set for PP pipes at 260°C, with electronic temperature control (EE) or fixed temperature for PP pipes at 263°C, with electronic temperature control (FE). Support stand. Bench support for mounting the welding unit in a horizontal or vertical position (not for MSG 25). Hexagon key for assembly and dismantling of heating spigots and heating sockets. In a carton.

Description	Pipes Ø mm	Power W	Art.-No.	€
<b>25 EE</b>	16–25	500	256020R220	<b>516,92</b>
<b>63 FE</b>	16–63	800	256213R220	<b>380,95</b>
<b>63 EE</b>	16–63	800	256220R220	<b>489,94</b>
<b>125 EE</b>	16–125	1400	256320R220	<b>725,56</b>

Other voltages available.

#### Supply format

**REMS MSG 63 FE Set.** As REMS MSG 63 FE, but with PTFE-coated heating spigots, heating sockets for Ø 20, 25, 32 mm. Fastening screws in stainless steel. In steel case.

Description	Pipes Ø mm	Power W	Art.-No.	€
	16–63	800	256233R220	<b>559,48</b>

Other voltages available.

#### Supply format

**REMS MSG 63 EE Set.** As REMS MSG 63 EE, but with PTFE-coated heating spigots, heating sockets for Ø 20, 25, 32 mm. Fastening screws in stainless steel. In steel case.

Description	Pipes Ø mm	Power W	Art.-No.	€
	16–63	800	256240R220	<b>799,26</b>

Other voltages available.

#### Accessories

Description	Pipes Ø mm	Art.-No.	€
<b>Heating spigot, heating socket, fastening screw</b> in stainless steel	16	256400	<b>54,81</b>
	17	256410	<b>54,81</b>
	18	256420	<b>54,81</b>
	19	256430	<b>54,81</b>
	20	256440	<b>54,81</b>
	25	256450	<b>60,93</b>
	32	256460	<b>68,20</b>
	40	256470	<b>90,10</b>
	50	256480	<b>103,38</b>
	63	256490	<b>139,09</b>
	75	256500	<b>244,97</b>
	90	256510	<b>265,73</b>
110	256520	<b>309,32</b>	
125	256530	<b>361,22</b>	
<b>Steel case</b>			
REMS MSG 25, REMS MSG 63		256242	<b>139,09</b>
REMS MSG 125		256342	<b>184,76</b>

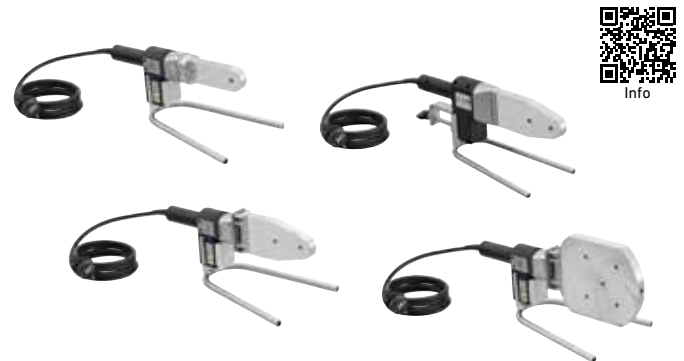

Handy, easy-to-carry compact machine. Complete only 45 kg. Ideal for sanitary installations and installation of drain pipes, chimney reconstruction with PVDF pipes. For job site and workshop.

### Plastic pipes and fittings

in PB, PE, PP, PVDF

Ø 40–160 mm

PE Ø 40–90 mm	SDR ≥ 6
PE Ø 40–110 mm	SDR ≥ 9
PE Ø 40–125 mm	SDR ≥ 11
PE Ø 40–140 mm	SDR ≥ 17
PE Ø 40–160 mm	SDR ≥ 21

### REMS SSM 160RS – ideal for the pipe fitter.

**Light and compact. Heating element according to DVS.**

**Electronic temperature control. High-quality PTFE coating.**

**Powerful facing cutter. Closed facing cutter housing.**

### Design

Light and compact. Low weight, complete only 60 kg.

Can be easily carried by one person.

- Base frame in cast aluminium
- Free suspension of butt welding unit REMS SSG 180 for exact alignment of the faces to be welded
- Electric facing cutter unit for plane-parallel machining of pipe ends
- Smooth sliding, roller-bearing mounting of butt welding unit and electric facing cutter unit
- Quick clamping device, also suitable for angular branches.
- Pressing device, clear scale for easy reading of jointing pressure, clamping handle for pressure holding
- Can be used on the workbench or on the tubular stand provided as standard (= sub-frame = transport device).

### Heating element according to DVS

Plate-shaped, plane parallel heating element according to DVS. Electric heater embedded in corrosion-resistant cast aluminium for indirect heat transfer. High-quality, long-lasting PTFE coating prevents adherence of plastic remnants as well as oxidizing, and enables easy cleaning. Ideal temperature distribution and constant temperature at the complete working area. Protective cover for heating element.

### Electronic temperature control

Adjustable temperature 180–290°C, preset for PE pipes. The electronic temperature control automatically controls the preset temperature within the permitted range according to DVS. Temperature control lamp and power control lamp.

### Facing cutter unit

Electric facing cutter unit with special, high torque universal motor, 500 W, for plane-parallel machining of one or both pipe ends according to DVS. Fast positioning of facing cutter with proven safety switch. Closed facing cutter housing. Specially hardened and specially ground planing blades guarantee easy, vibration-free planing.

### Quick clamping device, also for angular branches

Sturdy quick clamping device made of nickel-plated steel, consisting of 2 vices with 2 clamping inserts each for pipes of Ø 40, 50, 56, 63, 75, 90, 110, 125, 135, 140, 160 mm. Also suitable for angular branches.

### Pipe supports

Multiple adjustment, easy positioning of pipe supports for pipes Ø 160 mm for supporting and easy axial alignment of pipes and fittings. 2 pipe support inserts each for pipes Ø 40, 50, 56, 63, 75, 90, 110, 125, 135, 140 mm.

### Supply format

**REMS SSM 160RS.** Butt welding machine for plastic pipes and fittings in PB, PE, PP, PVDF, PE Ø 40–90 mm SDR ≥ 6, PE Ø 40–110 mm SDR ≥ 9, PE Ø 40–125 mm SDR ≥ 11, PE Ø 40–140 mm SDR ≥ 17, PE Ø 40–160 mm SDR ≥ 21. Butt welding unit with PTFE-coated heating element 230 V, 50–60 Hz, 1200 W. Adjustable temperature 180–290°C, preset for PE pipes. Electronic temperature control. Protective cover for heating element. Electric planing device 230 V, 50–60 Hz, 500 W. Pressing device. Quick clamping device, also for angular branches, consisting of 2 vices with 2 clamping inserts each Ø 40, 50, 56, 63, 75, 90, 110, 125, 135, 140, 160 mm. 2 pipe rests Ø 160 mm with pipe rest inserts Ø 40, 50, 56, 63, 75, 90, 110, 125, 135, 140 mm. Work key. Steel case for pipe support inserts and clamp inserts. Tubular stand = base frame = carrying device.

	Art.-No.	€
	252026R220	4.562,01

### Accessories

Description	Art.-No.	€
Planing blade (piece)	252103R	124,56



# REMS SSM 160KS

Butt welding machine

Powerful, proven, easy-to-transport compact machine. Ideal for sanitary installation, drain pipe installation, chimney reconstruction with PVDF pipes. For job site and workshop.

Plastic pipes and fittings

in PB, PE, PP, PVDF

Ø 40–160 mm

PE Ø 40–90 mm	SDR ≥ 6
PE Ø 40–110 mm	SDR ≥ 9
PE Ø 40–125 mm	SDR ≥ 11
PE Ø 40–140 mm	SDR ≥ 17
PE Ø 40–160 mm	SDR ≥ 21

**REMS SSM 160KS – ideal for the pipe fitter. Heating element according to DVS. Electronic temperature control. High-quality PTFE coating. Powerful facing cutter. Closed facing cutter housing.**

## Design

Compact, robust, job site-proven. Machine on sheet metal base weighs 101 kg. Easy to carry.

- Base frame in aluminium cast
- Free suspension of butt welding unit REMS SSG 180 for exact alignment of the faces to be welded
- Electric facing cutter unit for plane-parallel machining of pipe ends
- Smooth sliding, roller-bearing mounting of butt welding unit and electric facing cutter unit
- Quick clamping device, also suitable for angular branches.
- Pressing device, clear scale for easy reading of jointing pressure, clamping handle for pressure holding
- Machine on sheet steel base with built-in drawer for clamping and pipe rest inserts
- Suitable for use on a work bench or on the standard supplied sheet metal cabinet (= carrying case).

## Heating element according to DVS

Plate-shaped, plane-parallel heating element according to DVS. Electric heater embedded in corrosion-resistant cast aluminium for indirect heat transfer. High-quality, long-lasting PTFE coating prevents adherence of plastic remnants as well as oxidizing, and enables easy cleaning. Ideal temperature distribution and constant temperature at the complete working area. Protective cover for heating element.

## Electronic temperature control

Adjustable temperature 180–290°C, preset for PE pipes. The electronic temperature control automatically controls the preset temperature within the permitted range according to DVS. Temperature control lamp and power control lamp.

## Facing cutter unit

Electric facing cutter unit with special, high torque universal motor, 500 W, for plane-parallel machining of one or both pipe ends according to DVS. Fast positioning of facing cutter with proven safety switch. Closed facing cutter housing. Specially hardened and specially ground planing blades guarantee easy, vibration-free planing.

## Quick clamping device, also for angular branches

Sturdy quick clamping device made of nickel-plated steel, consisting of 2 vices with 2 clamping inserts each for pipes of Ø 40, 50, 56, 63, 75, 90, 110, 125, 135, 140, 160 mm. Also suitable for angular branches.

## Pipe supports

Multiple adjustment, easy positioning of pipe supports for pipes of Ø 160 mm for supporting and easy axial alignment of pipes and fittings. 2 pipe support inserts each for pipes Ø 40, 50, 56, 63, 75, 90, 110, 125, 135, 140 mm.

## Supply format

**REMS SSM 160KS.** Butt welding machine for plastic pipes and fittings in PB, PE, PP, PVDF, PE Ø 40–90 mm SDR ≥ 6, PE Ø 40–110 mm SDR ≥ 9, PE Ø 40–125 mm SDR ≥ 11, PE Ø 40–140 mm SDR ≥ 17, PE Ø 40–160 mm SDR ≥ 21. Butt welding unit with PTFE-coated heating element 230 V 50–60 Hz, 1200 W. Adjustable temperature 180–290°C, preset for PE pipes. Electronic temperature control. Protective cover for heating element. Electric planing device 230 V, 50–60 Hz, 500 W. Pressing device. Quick clamping device, also for angular branches, consisting of 2 vices with 2 clamping inserts each Ø 40, 50, 56, 63, 75, 90, 110, 125, 135, 140, 160 mm. 2 pipe rests Ø 160 mm with pipe rest inserts Ø 40, 50, 56, 63, 75, 90, 110, 125, 135, 140 mm. Sheet steel base with built-in drawer. Work key. Closed sheet metal cabinet = carrying case.

	Art.-No.	€
	252046R220	<b>6.087,87</b>

## Accessories

Description	Art.-No.	€
<b>Planing blade</b> (piece)	252103R	<b>124,56</b>



Powerful, proven, easy-to-transport compact machine. Ideal for sanitary installation, drain pipe installation, chimney reconstruction with PVDF pipes. For job site and workshop.

### Plastic pipes and fittings

in PB, PE, PP, PVDF	Ø 75–250 mm
PE Ø 75–140 mm	SDR ≥ 6
PE Ø 75–160 mm	SDR ≥ 9
PE Ø 75–180 mm	SDR ≥ 11
PE Ø 75–200 mm	SDR ≥ 13.6
PE Ø 75–225 mm	SDR ≥ 17.6
PE Ø 75–250 mm	SDR ≥ 22

## REMS SSM 250KS – compact and robust.

### Design

- Compact, robust, job site-proven. Easy to carry. Machine on sheet metal base weighs 109 kg.
- Base frame in aluminium cast
  - Free suspension of butt welding unit for exact alignment of the faces to be welded
  - Electric facing cutter unit for plane-parallel machining of pipe ends
  - Smooth sliding, roller-bearing mounting of butt welding unit and electric facing cutter unit
  - Quick clamping device, also suitable for angular branches.
  - Pressing device, clear scale for easy reading of jointing pressure, clamping handle for pressure holding
  - Machine on sheet steel base with built-in drawer for clamping and pipe rest inserts.
  - Suitable for use on a work bench or on the standard supplied sheet metal cabinet (= carrying case).

### Heating element according to DVS

Plate-shaped, plane-parallel heating element according to DVS. Electric heater embedded in corrosion-resistant cast aluminium for indirect heat transfer. High-quality, long-lasting PTFE coating prevents adherence of plastic remnants as well as oxidizing, and enables easy cleaning. Ideal temperature distribution and constant temperature at the complete working area.

### Electronic temperature control

Adjustable temperature 180–290°C, preset for PE pipes. The electronic temperature control automatically controls the preset temperature within the permitted range according to DVS. Temperature control lamp and power control lamp.

### Facing cutter unit

Electric facing cutter unit with special, high torque universal motor, 500 W, for plane-parallel machining of one or both pipe ends according to DVS. Fast positioning of facing cutter with proven safety switch. Closed facing cutter housing. Specially hardened and specially ground planing blades guarantee easy, vibration-free planing.

### Quick clamping device for angular branches

Sturdy quick clamping device made of nickel-plated steel which grips the pipe all round, consisting of 2 clamps Ø 250 mm with jaws Ø 250 mm, with 2 clamping jaws and 2 clamping inserts each for pipes of Ø 75, 90, 110, 125, 160, 200 mm. Also suitable for angular branches. Clamping jaws and clamping inserts available for pipes of Ø 140, 180, 225 mm.

### Pipe supports

Multiple adjustment, easy positioning of pipe supports for supporting and easy axial alignment of pipes and fittings. 2 pipe support inserts each for pipes Ø 75, 90, 110, 125, 140, 160, 180, 200, 225, 250 mm. Pipe rest inserts available for pipes of Ø 140, 180, 225 mm.



Info



## Supply format

**REMS SSM 250K.** Butt welding machine for plastic pipes and fittings in PB, PE, PP, PVDF. PE Ø 75–140 mm SDR ≥ 6, PE Ø 75–160 mm SDR ≥ 9, PE Ø 75–180 mm SDR ≥ 11, PE Ø 75–200 mm SDR ≥ 13.6, PE Ø 75–225 mm SDR ≥ 17.6, PE Ø 75–250 mm SDR ≥ 22. Butt welding unit with PTFE-coated heating element 230 V, 50–60 Hz, 1300 W. Adjustable temperature 180–290°C, preset for PE pipes. Electronic temperature control. Electric facing cutter unit 230 V, 50–60 Hz, 500 W. Quick clamping device, also for angular branches, consisting of 2 clamps Ø 250 mm with jaws Ø 250 mm, with 2 clamping jaws and 2 clamping inserts each for pipes of Ø 75, 90, 110, 125, 160, 200 mm. 2 pipe rests with pipe rest inserts Ø 75, 90, 110, 125, 160, 200, 250 mm. Sheet steel base with built-in drawer. Work key. Closed sheet metal cabinet = carrying case.

	Art.-No.	€
	254025R220	9.881,76

## Accessories

Description	Art.-No.	€
Planing blade (piece)	254103	183,73



# REMS SSM 315RF

Butt welding machine

Compact, easy-to-transport high-performance machine for sanitary installation, drain pipe installation, chimney reconstruction with PVDF pipes. For job site and workshop.

## Plastic pipes and fittings

in PB, PE, PP, PVDF Ø 90 – 315 mm

PE Ø 90 – 180 mm	SDR ≥ 6
PE Ø 90 – 200 mm	SDR ≥ 7.4
PE Ø 90 – 225 mm	SDR ≥ 9
PE Ø 90 – 250 mm	SDR ≥ 13.6
PE Ø 90 – 280 mm	SDR ≥ 17
PE Ø 90 – 315 mm	SDR ≥ 21

## REMS SSM 315RF – convenient for job site and workshop.

### Design

Compact, robust, job site-proven. Weight including tubular stand on wheels 154 kg.

- Base frame in aluminium cast
- Free suspension of butt welding unit for exact alignment of the faces to be welded
- Electric facing cutter unit for plane-parallel machining of pipe ends
- Smooth sliding, roller-bearing mounting of butt welding unit and electric facing cutter unit
- Quick clamping device
- Pressing device, clear scale for easy reading of jointing pressure, clamping handle for pressure holding
- Standard supply with tubular wheel stand for secure standing and easy transport.

### Heating element according to DVS

Plate-shaped, plane-parallel heating element according to DVS. Electric heater embedded in corrosion-resistant cast aluminium for indirect heat transfer. High-quality, long-lasting PTFE coating prevents adherence of plastic remnants as well as oxidizing, and enables easy cleaning. Ideal temperature distribution and constant temperature at the complete working area.

### Electronic temperature control

Adjustable temperature 180 – 290 °C, preset for PE pipes. The electronic temperature control automatically controls the preset temperature within the permitted range according to DVS. Temperature control lamp and power control lamp.

### Facing cutter unit

Electric facing cutter unit with special, high torque universal motor, 500 W, for plane-parallel machining of one or both pipe ends according to DVS. Fast positioning of facing cutter with proven safety switch. Closed facing cutter housing. Specially hardened and specially ground planing blades guarantee easy, vibration-free planing.

### Quick clamping device

Sturdy quick clamping devices made of nickel-plated steel which grip the pipe all round, for pipes of Ø 315 mm. 4 clamping inserts each for pipes of Ø 90, 110, 125, 160, 200, 250 mm. Clamping inserts available for pipes of Ø 140, 180, 225, 280 mm.

### Pipe supports

Multiple adjustment, easy positioning of pipe supports for pipes Ø 315 mm for supporting and easy axial alignment of pipes and fittings. 2 pipe rest inserts each for pipes of Ø 90, 110, 125, 160, 200, 250 mm. Pipe rest inserts available for pipes of Ø 140, 180, 225, 280 mm.

## Supply format

**REMS SSM 315RF.** Butt welding machine for plastic pipes and fittings in PB, PE, PP, PVDF. PE Ø 90 – 180 mm SDR ≥ 6, PE Ø 90 – 200 mm SDR ≥ 7.4, PE Ø 90 – 225 mm SDR ≥ 9, PE Ø 90 – 250 mm SDR ≥ 13.6, PE Ø 90 – 280 mm SDR ≥ 17, PE Ø 90 – 315 mm SDR ≥ 21. Butt welding unit with PTFE-coated heating element 230 V, 50 – 60 Hz, 3000 W. Adjustable temperature 180 – 290 °C, preset for PE pipes. Electronic temperature control. Electric facing cutter unit 230 V, 50 – 60 Hz, 500 W. Pressing device. 2 quick clamping devices Ø 315 mm with 2 clamping inserts each for pipes of Ø 90, 110, 125, 160, 200, 250 mm. 2 pipe supports Ø 315 mm with pipe support inserts Ø 90, 110, 125, 160, 200, 250 mm. Ring spanner. Boxes for clamping and pipe rest inserts. Tubular stand on wheels.

	Art.-No.	€
	255020R220	13.491,92

## Accessories

Description	Art.-No.	€
<b>Planing blade</b> (piece)	255103	196,18

All prices excl. VAT



Powerful electric tools for efficient butt welding.  
Can be used anywhere, free-hand or on the work bench.

Plastic pipes and fittings  
in PB, PE, PP, PVDF ≤ Ø 280 mm

### REMS SSG – heating element according to DVS.

#### Electronic temperature control.

#### High-quality PTFE coating.

#### Design

Handy, light, safe. Free-hand or work bench assembly. Supplied as standard with supporting stand. Bench support available as accessory for mounting the unit in a horizontal or vertical position.

#### Heating element according to DVS

Plate-shaped, plane parallel heating element according to DVS. Electric heater embedded in corrosion-resistant cast aluminium for indirect heat transfer. High-quality, long-lasting PTFE coating prevents adherence of plastic remnants as well as oxidizing, and enables easy cleaning. Ideal temperature distribution and constant temperature at the complete working area.

#### Electronic temperature control

Adjustable temperature 180–290°C, preset for PE pipes. The electronic temperature control automatically controls the preset temperature within the permitted range according to DVS. Temperature control lamp and power control lamp.



Info



### Supply format

**REMS MSG.** Butt welding unit for plastic pipes and fittings in PB, PE, PP, PVDF. PTFE-coated heating element 230 V, 50–60 Hz. Adjustable temperature 180–290°C, preset for PE pipes. Electronic temperature control. Support stand. In a carton.

Description	Heating element Ø mm	Pipes ≤ Ø mm	Power W	Art.-No.	€
<b>110/45° EE</b>	125	110	500	250020R220	<b>517,96</b>
<b>125 EE</b>	145	125	700	250120R220	<b>560,52</b>
<b>180 EE</b>	200	180	1200	250220R220	<b>643,56</b>
<b>280 EE</b>	300	280	1300	250320R220	<b>778,50</b>

### Accessories

Description	Art.-No.	€
<b>Bench support for mounting the unit</b> in a horizontal or vertical position		
REMS SSG 110/45°, 125, 180	250041	<b>69,23</b>
REMS SSG 280	250341	<b>71,10</b>
<b>Steel case</b>		
REMS SSG 110/45°	250042	<b>107,95</b>
REMS SSG 125	250142	<b>107,95</b>
REMS SSG 180	250242	<b>107,95</b>
REMS SSG 280	250342	<b>153,62</b>
<b>Protection cover for heating element</b>		
REMS SSG 110, 110/45°, 125	250143	<b>42,87</b>
REMS SSG 180	250243	<b>44,12</b>
REMS SSG 280	250343	<b>50,65</b>

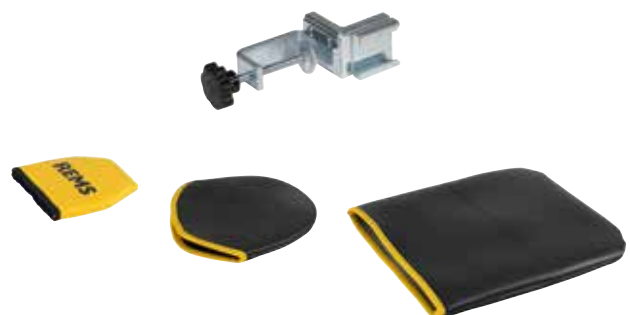















# Diamond core drilling

## Diamond chasing and cutting machine

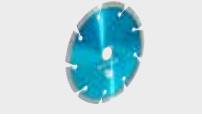
### Wet and dry suction

	<b>Electric diamond core drilling machines</b>	<b>302</b>
	<b>Drill stands</b>	<b>310</b>
	<b>Universal diamond core drilling crowns</b>	<b>312</b>
	<b>Universal diamond core drilling crowns LS</b>	<b>314</b>
	<b>Electric diamond core drilling machine with micro-pulse technology</b>	<b>316</b>
	<b>Dry diamond core drilling crowns LS</b>	<b>319</b>
	<b>Tile drilling</b>	<b>320</b>
	<b>Diamond chasing and cutting machine</b>	<b>322</b>
	<b>Diamond cutting discs</b>	<b>323</b>
	<b>Dry and wet extractor</b>	<b>324</b>

Compact, handy power tool for core drilling, e.g. in concrete, steel-reinforced concrete, all kinds of masonry, natural stone, asphalt, all kinds of screed. Dry or wet drilling, hand held or with drill stand. For trade and industry.

Concrete, steel-reinforced concrete	≤ Ø 102 (132) mm
Masonry and other materials	≤ Ø 162 mm

REMS Universal diamond core drilling crowns, also suitable for drive machines of other makes, see page 312–314.

**REMS Picus S1 – Core drilling instead of chiselling. Easy, fast, vibration-free, e.g. 200 mm in steel-reinforced concrete Ø 62 mm in only 3 min.**

**1 system – 4 applications. Ideal for plumbers.**

### Universal use

Universal drive machine for dry or wet drilling, hand held or with drill stand. Can be used anywhere, in narrow angles, flush with the wall. For many materials. For pipeline and cable ducting, ventilation channels, test core drilling.

### System advantage

Only **one** type of universal diamond core drilling crowns for all REMS Picus drive machines and other suitable makes of drive machines. Therefore simple, low cost storage. No confusion possible.

### Design

Compact, handy drive machine for vibration-free core drilling, with drilling crown connecting thread UNC 1¼ male, BSPP ½ female. Robust, suitable for the building site. Extra light, only 5.2 kg. Simple, fast work, e.g. 200 mm in steel-reinforced concrete Ø 62 mm in only 3 min. Practical spade handle and stabiliser for hand held drilling. Throat Ø 60 mm for holding the drive machine in the drill stand. Water supply for wet drilling, with adjustable shut-off valve and quick-coupling with water stop and hose connection ½". Suction rotor for sucking off dust for dry drilling with connection for conventional vacuum cleaner, as accessory.

### Drive

Robust, powerful 1850 W universal motor. Load speed drilling spindle 580 rpm. Stable, maintenance-free gear. Blocking protection by safety slip clutch. Tip strength with lock. Connecting cable with integrated personal protection switch (PRCD).

### Multifunction electronics

Multifunction electronics with start-up current limiting for soft starting for delicate drilling start, automatic idle speed limiting for noise reduction and preservation of the motor, overload and blocking protection for motor and gear.

### Universal diamond core drilling crowns

Universally usable for dry and wet drilling, hand held or with drill stand. Optionally REMS Universal diamond core drilling crowns, inductively soldered, resolderable or REMS Universal diamond core drilling crowns LS, laser welded, high temperature-resistant (page 312–314). Connecting thread UNC 1¼ female. Drilling depth 420 mm. Specially developed, high quality diamond segments with high diamond percentage and special bonding, for excellent drilling performance and very long life. Ideal for universal applications in steel-reinforced concrete and masonry. Adapter for using the REMS Universal diamond core drilling crowns in drive machines of other makes, as accessory. Light loosening ring, for light loosening of the diamond core crown, as accessory.

### Dust extraction in accordance with EN 60335-2-69

When working with mineral building materials, e.g. concrete, steel-reinforced concrete, masonry and screed, a high degree of mineral dust containing quartz is produced which is harmful to the health. Inhalation of quartz fine dust is harmful to the health. EN 60335-2-69 prescribes the use of at least one safety extractor of dust class M for the extraction of health hazardous dusts with an exposure limit/work place limit of > 0.1 mg/m³. Observe the national regulations.

Suction rotor for dust extraction in dry drilling with connection for REMS Pull 2 and other suitable extractors, as accessory (page 311). REMS Pull 2 M, wet and dry dust extractor, certified for extracting health hazardous dusts of dust class M (page 324).

### Drilling start aid

Drilling start aid G ½ UDKB, with bores for extracting the drilling dust from the bore hole by a suction rotor for dust extraction, with carbide masonry drill Ø 8 mm.

### Water extractor unit

Water extractor unit for wet drilling up to Ø 170 mm, consisting of a water collector ring with connection for REMS Pull 2 or other suitable wet extractors, compression ring, rubber washer Ø 200 mm, adaptable to diameter of the drill crown and universal pressure pad for all REMS drill stands, as accessory.

### Drill stand

REMS Simplex 2 or REMS Titan drill stands can be used optionally (page 310).



Info



REMS Simplex 2



REMS Titan



REMS Picus S1 Basic-Pack

### Supply format

**REMS Picus S1 Basic-Pack.** Electric diamond core drilling machine for core drilling in concrete, steel-reinforced concrete  $\leq \varnothing 102$  (132) mm, masonry and other materials  $\leq \varnothing 162$  mm. For dry and wet drilling, hand held or with drill stand. Drive machine with drilling crown connecting thread UNC 1 1/4 male, BSPP 1/2 female, maintenance-free gear with safety slip clutch, universal motor 230 V, 50–60 Hz, 1850 W. Multifunction electronics with soft starting, idle speed limiting, overload protection, blocking protection. Touch switch with lock. Personal protection switch (PRCD). Load speed drilling spindle 580 rpm. Water supply device with adjustable shut-off valve and quick coupling with water stop and 1/2" hose connection. Stabiliser. Drilling start aid G 1/2 UDKB with drill  $\varnothing 8$  mm, Allen key size 3. Single open-ended wrench size 32. In sturdy steel case.

	Art.-No.	€
	180010R220	1.629,66

Other voltages on request.

### Supply format

**REMS Picus S1 Set Simplex 2.** REMS Picus S1 Basic-Pack with REMS Simplex 2 drilling stand including tools and fastening kit for masonry and concrete.

	Art.-No.	€
	180032R220	2.646,90

Other voltages on request.



REMS Picus S1 Set Simplex 2

### Accessories

Description	Art.-No.	€
<b>REMS Picus S1 drive unit</b>	180000R220	1.577,76
<b>Steel case with inlay</b>	180600R	128,71
<b>REMS Universal diamond core drilling crowns,</b> inductively soldered, resolderable, see page 312.		
<b>REMS universal diamond core drilling crowns LS,</b> laser welded, high temperature-resistant, see page 314.		
<b>REMS Pull 2 L / M,</b> dry and wet extractors, see page 324		
Additional accessories see page 310–311.		



Powerful, handy power tool for core drilling, e.g. in concrete, steel-reinforced concrete, all kinds of masonry, natural stone, asphalt, all kinds of screed. Dry or wet drilling, hand held or with drill stand. For trade and industry.

Concrete, steel-reinforced concrete	≤ Ø 152 (200) mm
Masonry and other materials	≤ Ø 250 mm

REMS Universal diamond core drilling crowns, also suitable for drive machines of other makes, see page 312–314.

**REMS Picus S3 – Core drilling instead of chiselling. Easy, fast, vibration-free, e.g. 200 mm in steel-reinforced concrete Ø 62 mm in only 3 min.**

**1 system – 4 applications. Ideal for plumbers.**

### Universal use

Universal drive machine for dry or wet drilling, hand held or with drill stand. Can be used anywhere, in narrow angles, flush with the wall. Extremely versatile and efficient, e.g. drilling in steel-reinforced concrete, masonry and other materials. For pipeline and cable ducting, ventilation channels, test core drilling.

### System advantage

Only **one** type of universal diamond core drilling crowns for all REMS Picus drive machines and other suitable makes of drive machines. Therefore simple, low cost storage. No confusion possible.

### Design

Compact, handy drive machine for vibration-free core drilling, with drilling crown connecting thread UNC 1¼ male, BSPP ½ female. Robust, suitable for the building site. Only 7.4 kg. Simple, fast work, e.g. 200 mm in steel-reinforced concrete Ø 62 mm in only 3 min. Practical spade handle and stabiliser for hand held drilling. Throat Ø 60 mm for holding the drive machine in the drill stand. Water supply for wet drilling, with adjustable shut-off valve and quick-coupling with water stop and hose connection ½". Suction rotor for sucking off dust for dry drilling with connection for conventional vacuum cleaner, as accessory.

### Drive

Robust, powerful 2200 W universal motor. Stable, maintenance-free 3-speed gear for optimum selection of load speed according to the drilling diameter. Load speed drilling spindle 530 rpm, 1280 rpm, 1780 rpm. Blocking protection by safety slip clutch. Tip switch with lock. Connecting cable with integrated personal protection switch (PRCD).

### Multifunction electronics

Multifunction electronics with start-up current limiting for soft starting for delicate drilling start, automatic idle speed limiting for noise reduction and preservation of the motor, overload and blocking protection for motor and gear.

### Universal diamond core drilling crowns

Universally usable for dry and wet drilling, hand held or with drill stand. Optionally REMS Universal diamond core drilling crowns, inductively soldered, resolderable or REMS Universal diamond core drilling crowns LS, laser welded, high temperature-resistant (page 312–314). Connecting thread UNC 1¼ female. Drilling depth 420 mm. Specially developed, high quality diamond segments with high diamond percentage and special bonding, for excellent drilling performance and very long life. Ideal for universal applications in steel-reinforced concrete and masonry. Adapter for using the REMS Universal diamond core drilling crowns in drive machines of other makes, as accessory. Light loosening ring, for light loosening of the diamond core crown, as accessory.

### Dust extraction in accordance with EN 60335-2-69

When working with mineral building materials, e.g. concrete, steel-reinforced concrete, masonry and screed, a high degree of mineral dust containing quartz is produced which is harmful to the health. Inhalation of quartz fine dust is harmful to the health. EN 60335-2-69 prescribes the use of at least one safety extractor of dust class M for the extraction of health hazardous dusts with an exposure limit/work place limit of > 0.1 mg/m³. Observe the national regulations.

Suction rotor for dust extraction in dry drilling with connection for REMS Pull 2 and other suitable extractors, as accessory (page 311). REMS Pull 2 M, wet and dry dust extractor, certified for extracting health hazardous dusts of dust class M (page 324).

### Drilling start aid

Drilling start aid G ½ UDKB, with bores for extracting the drilling dust from the bore hole by a suction rotor for dust extraction, with carbide masonry drill Ø 8 mm, as accessory.

### Water extractor unit

Water extractor unit for wet drilling up to Ø 170 mm, consisting of a water collector ring with connection for REMS Pull 2 or other suitable wet extractors, compression ring, rubber washer Ø 200 mm, adaptable to diameter of the drill crown and universal pressure pad for all REMS drill stands, as accessory.

### Drill stand

REMS Simplex 2 or REMS Titan drill stands can be used optionally (page 310).

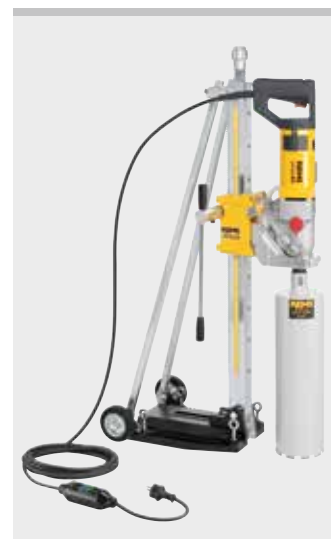

Info



REMS Simplex 2



REMS Titan





REMS Picus S3 Basic-Pack



REMS Picus S3 Set Titan



REMS Picus S3 Set 62-82-132 Titan

### Supply format

**REMS Picus S3 Basic-Pack.** Electric diamond core drilling machine for core drilling in concrete, steel-reinforced concrete  $\leq \varnothing 152$  (200) mm, masonry and other materials  $\leq \varnothing 250$  mm. For dry and wet drilling, hand held or with drill stand. Drive machine with drilling crown connecting thread UNC 1 1/4 male, BSPP 1/2 female, maintenance-free 3-speed gear with safety slip clutch, universal motor 230 V, 50–60 Hz, 2200 W. Multifunction electronics with soft starting, idle speed limiting, overload protection, blocking protection. Touch switch with lock, personal protection switch (PRCD). Load speed drilling spindle 530 rpm, 1280 rpm, 1780 rpm. Water supply with adjustable shut-off valve and quick-coupling with water stop and hose connection 1/2". Stabiliser. Starting aid BSPP 1/2, Allen key size 3. Single open-ended wrench size 32. In sturdy steel case.

	Art.-No.	€
	180011R220	2.024,10

Other voltages on request.

### Supply format

**REMS Picus S3 Set Titan.** REMS Picus S3 Basic-Pack with REMS Titan drilling stand including fastening kit for masonry and concrete.

	Art.-No.	€
	180029R220	3.570,72

Other voltages on request.

### Supply format

**REMS Picus S3 Set 62+82+132 Titan.** REMS Picus S3 Basic-Pack with REMS Universal diamond core drilling crowns UDKB  $\varnothing 62+82+132$  mm and REMS Titan drilling stand including fastening kit for masonry and concrete.

	Art.-No.	€
	180028R220	4.198,71

Other voltages on request.

### Accessories

Description	Art.-No.	€
<b>REMS Picus S3 drive unit</b>	180001R220	1.972,20
<b>Steel case with inlay</b>	180600R	128,71
<b>REMS Universal diamond core drilling crowns</b> , inductively soldered, resolderable, see page 312.		
<b>REMS universal diamond core drilling crowns LS</b> , laser welded, high temperature-resistant, see page 314.		
<b>REMS Pull 2 L / M</b> , dry and wet extractors, see page 324		
Additional accessories see page 310–311.		



Compact, handy power tool for core drilling, e.g. in concrete, steel-reinforced concrete, all kinds of masonry, natural stone, asphalt, all kinds of screed. With speed regulation. Dry or wet drilling, hand held or with drill stand. For trade and industry.

Concrete, steel-reinforced concrete	≤ Ø 162 (200) mm
Masonry and other materials	≤ Ø 250 mm

REMS Universal diamond core drilling crowns, also suitable for drive machines of other makes, see page 312–314.

**REMS Picus SR – Core drilling instead of chiselling. Easy, fast, vibration-free, e.g. 200 mm in steel-reinforced concrete Ø 62 mm in only 3 min. With speed regulation.**

**1 system – 4 applications.**

**Ideal for plumbers.**

### Universal use

Universal drive machine for dry or wet drilling, hand held or with drill stand. Can be used anywhere, in narrow angles, flush with the wall. Extremely versatile and efficient, e.g. drilling in steel-reinforced concrete, masonry and other materials. For pipeline and cable ducting, ventilation channels, test core drilling.

### System advantage

Only **one** type of universal diamond core drilling crowns for all REMS Picus drive machines and other suitable makes of drive machines. Therefore simple, low cost storage. No confusion possible.

### Design

Compact, handy drive machine for vibration-free core drilling, with drilling crown connecting thread UNC 1¼ male, BSPP ½ female. Robust, suitable for the building site. Extra light, only 6.4 kg. Simple, fast work, e.g. 200 mm in steel-reinforced concrete Ø 62 mm in only 3 min. Practical spade handle and stabiliser for hand held drilling. Throat Ø 60 mm for holding the drive machine in the drill stand. Spacer set for additional stabilisation of the REMS Picus SR drive unit on the REMS Titan drill stand. Water supply for wet drilling, with adjustable shut-off valve and quick-coupling with water stop and hose connection ½".

### Drive

Robust, powerful 2200 W universal motor. Overheating protection by temperature monitoring of the motor's field winding with a PTC resistor (Positive Temperature Coefficient). Stable, maintenance-free, 2-step gear. Blocking protection by safety slip clutch. Tip switch with lock. Connecting cable with integrated personal protection switch (PRCD).

### Speed-Regulation

Stepless electronic speed regulation of the drive machine for selecting the speed according to the material. The speed is steplessly adjustable on the dial: 250 rpm to 500 rpm (1<sup>st</sup> gear) or 600 rpm to 1200 rpm (2<sup>nd</sup> gear). The electronic speed control that is being used keeps the selected speed constant, also under load. The speed of the drilling crown is kept at the nominal value until it meets with resistance and drops below a critical value. The drive motor stops. When the load on the drive unit is relieved again, the drill runs back up to nominal speed so that work can continue immediately at nominal speed (Patent EP 2 085 191). Advantage: The optimum drilling speed (load speed) selected for the respective material and the drilling crown diameter remains constant for the entire duration of the drilling. For the best drilling performance and maximum life of the drilling crowns.

### Multifunction electronics

Multifunction electronics with start-up current limiting for soft starting for delicate drilling start, automatic idle speed limiting for noise reduction and preservation of the motor, overload and blocking protection for motor and gear.

### Universal diamond core drilling crowns

Universally usable for dry and wet drilling, hand held or with drill stand. Optionally REMS Universal diamond core drilling crowns, inductively soldered, resolderable or REMS Universal diamond core drilling crowns LS, laser welded, high temperature-resistant (page 312–314). Connecting thread UNC 1¼ female. Drilling depth 420 mm. Specially developed, high quality diamond segments with high diamond percentage and special bonding, for excellent drilling performance and very long life. Ideal for universal applications in steel-reinforced concrete and masonry. Adapter for using the REMS Universal diamond core drilling crowns in drive machines of other makes, as accessory. Light loosening ring, for light loosening of the diamond core crown, as accessory.

### Dust extraction in accordance with EN 60335-2-69

When working with mineral building materials, e.g. concrete, steel-reinforced concrete, masonry and screed, a high degree of mineral dust containing quartz is produced which is harmful to the health. Inhalation of quartz fine dust is harmful to the health. EN 60335-2-69 prescribes the use of at least one safety extractor of dust class M for the extraction of health hazardous dusts with an exposure limit/work place limit of > 0.1 mg/m³. Observe the national regulations.

Suction rotor for dust extraction in dry drilling with connection for REMS Pull 2 and other suitable extractors, as accessory (page 311). REMS Pull 2 M, wet and dry dust extractor, certified for extracting health hazardous dusts of dust class M (page 324).

Patent EP 2 085 191

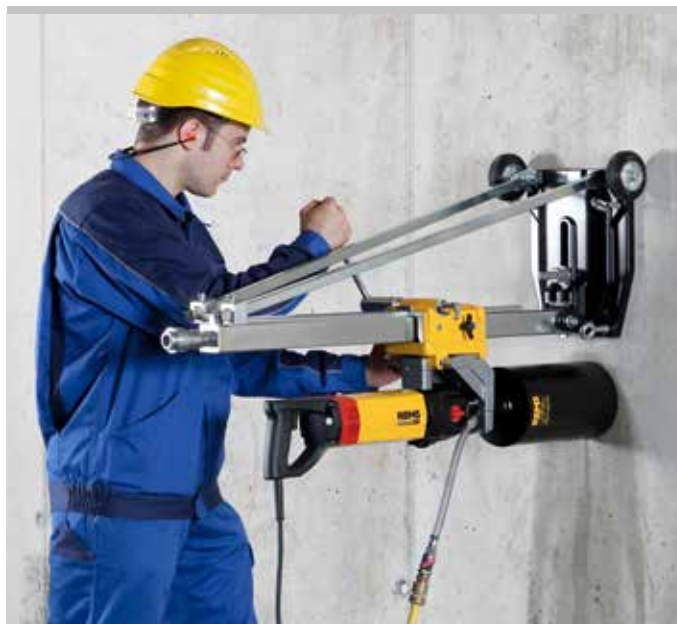

German Quality Product



Info

With speed regulation for the best drilling performance and maximum life of the drilling crowns.



REMS Simplex 2



REMS Titan

### Drilling start aid

Drilling start aid G ½ UDKB, with bores for extracting the drilling dust from the bore hole by a suction rotor for dust extraction, with carbide masonry drill Ø 8 mm, as accessory.

### Drill stand

REMS Simplex 2 or REMS Titan drill stands can be used optionally (page 310).

### Water extractor unit

Water extractor unit for wet drilling up to Ø 170 mm, consisting of a water collector ring with connection for REMS Pull 2 or other suitable wet extractors, compression ring, rubber washer Ø 200 mm, adaptable to diameter of the drill crown and universal pressure pad for all REMS drill stands, as accessory.



REMS Picus SR Basic-Pack



REMS Picus SR Set Titan



REMS Picus SR Set 62-82-132 Titan

### Supply format

**REMS Picus SR Basic-Pack.** For core drilling in concrete, steel-reinforced concrete ≤ Ø 162 (200) mm, masonry and other materials ≤ Ø 250 mm. For dry or wet drilling, hand held or with drill stand. Drive machine with drilling crown connection thread UNC 1¼ male, G ½ female, maintenance-free 2-step gear with safety slip clutch, universal motor 230 V, 50–60 Hz, 2200 W. Stepless electronic speed regulation 250 rpm to 500 rpm (1<sup>st</sup> gear) or 600 rpm to 1200 rpm (2<sup>nd</sup> gear), overheating protection. Multifunction electronics with soft starting, idle speed limiting, overload protection, blocking protection. Touch switch with lock. Personal protection switch (PRCD). Water supply device with adjustable shut-off valve and quick coupling with water stop and ½" hose connection. Stabiliser. Spacer set. Single open ended wrench size 32. In sturdy steel case.

Art.-No.	€
183010R220	1.712,70

Other voltages on request.

### Supply format

**REMS Picus SR Set Titan.** REMS Picus SR Basic-Pack with REMS Titan drilling stand including fastening kit for masonry and concrete.

Art.-No.	€
183022R220	3.093,24

Other voltages on request.

### Supply format

**REMS Picus SR Set 62+82+132 Titan.** REMS Picus SR Basic-Pack with REMS Titan drilling stand including fastening kit for masonry and concrete and REMS Universal diamond core drilling crowns UDKB Ø 62+82+132 mm.

Art.-No.	€
183023R220	3.581,10

Other voltages on request.

### Accessories

Description	Art.-No.	€
<b>REMS Picus SR drive unit</b>	183000R220	1.328,64
<b>Spacer set</b> for additional stabilisation of the REMS Picus SR drive unit on the REMS Titan drill stand, consisting of spacer and 2 cylinder head screws M 8×65	183632R	48,58
<b>Steel case</b> with inlay	180600R	128,71
<b>REMS Universal diamond core drilling crowns</b> , inductively soldered, resolderable, see page 312.		
<b>REMS universal diamond core drilling crowns LS</b> , laser welded, high temperature-resistant, see page 314.		
<b>REMS Pull 2 L / M</b> , dry and wet extractors, see page 324		
Additional accessories see page 310–311.		



Powerful, robust core drilling machine for core drilling, e.g. in concrete, steel-reinforced concrete, all kinds of masonry, natural stone, asphalt, all kinds of screed. Dry or wet drilling with drill stand. For installation, metalwork, industry.

Concrete, steel-reinforced concrete, masonry and other materials  $\varnothing$  40–300 mm

REMS Universal diamond core drilling crowns, also suitable for drive machines of other makes, see page 312–314.

**REMS Picus S2/3,5 – Core drilling instead of chiselling. Easy, fast, vibration-free, e.g. 200 mm in steel-reinforced concrete  $\varnothing$  62 mm in only 2 min.**

### Universal use

Universal drive machine for dry or wet drilling, hand held or with drill stand. Can be used anywhere, in narrow angles, flush with the wall. Extremely versatile and efficient, e.g. drilling in steel-reinforced concrete, masonry and other materials. For pipeline and cable ducting, ventilation channels, test core drilling.

### System advantage

Only one type of universal diamond core drilling crowns for all REMS Picus drive machines and other suitable makes of drive machines. Therefore simple, low cost storage. No confusion possible.

### Design

Compact, handy drive machine for vibration-free core drilling, with drilling crown connecting thread UNC 1 1/4 male. Light loosening ring, for light loosening of the diamond core crowns. Compact, robust, suitable for the building site. Weight just 14.4 kg. Simple, fast work, e.g. 200 mm in steel-reinforced concrete  $\varnothing$  62 mm in only 2 min. Clamping plate for fast clamping to the drill stand. Water supply for wet drilling, with adjustable shut-off valve and quick coupling with water stop and hose connection 1/2".

### Drive

Robust, powerful 3420 W universal motor. Stable, maintenance-free 2-speed gear for optimum selection of load speed according to the drilling diameter. Load speed drilling spindle 320 rpm, 760 rpm. Blocking protection by safety slip clutch. Rocker switch. Connecting cable with integrated personal protection switch (PRCD).

### Multifunction electronics

Multifunction electronics with start-up current limiting for soft starting for delicate drilling start, automatic idle speed limiting for noise reduction and preservation of the motor, overload and blocking protection for motor and gear.

### Universal diamond core drilling crowns

Universally usable for dry and wet drilling, hand held or with drill stand. Optionally REMS Universal diamond core drilling crowns, inductively soldered, resolderable or REMS Universal diamond core drilling crowns LS, laser welded, high temperature-resistant (page 312–314). Connecting thread UNC 1 1/4 female. Drilling depth 420 mm. Specially developed, high quality diamond segments with high diamond percentage and special bonding, for excellent drilling performance and very long life. Ideal for universal applications in steel-reinforced concrete and masonry. Adapter for using the REMS Universal diamond core drilling crowns in drive machines of other makes, as accessory. Light loosening ring, for light loosening of the diamond core crown, as accessory.

### Water extractor unit

Water extractor unit for wet drilling up to  $\varnothing$  170 mm, consisting of a water collector ring with connection for REMS Pull 2 or other suitable wet extractors, compression ring, rubber washer  $\varnothing$  200 mm, adaptable to diameter of the drill crown and universal pressure pad for all REMS drill stands, as accessory.

### Drill stand REMS Titan

Robust, highly stable drilling stand for core drilling in steel-reinforced concrete and other materials up to  $\varnothing$  300 mm. For high demands. Drill column made of rigid, unbendable square precision steel tube  $\varnothing$  50 mm, with extra narrow tolerance, for low-vibration guiding of the slide. Continuously tiltable with degree scale up to 45°, with double support by adjustable, single-part steel girders, for maximum thrust pressure. Highly stable, 3-sided guidance of the drill column in the base plate and triple cross fastening for high rigidity in vertical drilling. 4 Eyebolts for levelling unevenness of the floor, for exact standing position. Drill depth scale. Slide guided on all sides by adjustable, pretensioned plastic slide bearings. Precision in-feed drive ensures easy, low-vibration drilling and precise, low-vibration drill thrust. For high thrust pressure and long life of the drilling crowns. Spirit level integrated in the slide for exact alignment of the drill stand. Locking of the slide for simple assembly of the drilling crown and safe transport. Rigid connection plate made of wear-resistant spheroidal iron. Quick-clamping device for accommodating drive units with a suitable connection plate. Highly stable clamping bracket, unbendable and rigid, for accommodating drive units with  $\varnothing$  60 mm clamping throat. Rack and pinion force transmission with ergonomically designed pressing lever which can be inserted in both sides of the slide. Wide steel rack. Base plate with groove for sealing ring of the vacuum fastening. Vacuum fastening as accessory. Drill column with adjustable clamping head for clamping the drill stand between the ceiling and floor or between two walls. Mobile drill stand for easy transport. Weight 19.5 kg.

With tools, consisting of Allen key size 6, single open ended wrench size SW 19 and SW 30 and fastening kit for masonry and concrete, consisting of 2 M12 splaying anchors, 10 M12 hammer anchors for concrete, setting iron for M12 hammer anchors, cord threaded bar M12 x 52, quick clamping nut, washer, carbide masonry drill  $\varnothing$  15 mm SDS-plus, in box.



Info



REMS Titan



REMS Picus S2/3,5 Basic-Pack

### Supply format

**REMS Picus S2/3,5 Basic-Pack.** Electric diamond core drilling machine for core drilling in concrete, steel-reinforced concrete, all kinds of masonry, natural stone, asphalt, all kinds of screed, Ø 40 – 300 mm. For dry and wet drilling with drill stand. Drive machine with drilling crown connecting thread UNC 11/4 male, maintenance-free 2-speed gear with safety slip clutch, universal motor 230 V, 50 – 60 Hz, 3420 W. Multifunction electronics with soft starting, idle speed limiting, overload protection, blocking protection. Touch switch with lock. Personal protection switch (PRCD). Load speed drilling spindle 320 rpm, 760 rpm. Water supply device with adjustable shut-off valve and quick coupling with water stop and hose connection 1/2". Light loosening ring. Single open-ended wrench size 32. In a carton.

	Art.-No.	€
	180012R220	<b>3.176,28</b>

Other voltages on request.

### Supply format

**REMS Picus S2/3,5 Set Titan.** REMS Picus SR/3.5 Basic-Pack with REMS Titan drilling stand including fastening kit for masonry and concrete.

	Art.-No.	€
	180030R220	<b>4.722,90</b>

Other voltages on request.



REMS Picus S2/3,5 Set Titan

### Accessories

#### Description

**REMS Universal diamond core drilling crowns,** inductively soldered, resolderable, see page 312.

**REMS universal diamond core drilling crowns LS,** laser welded, high temperature-resistant, see page 314.

**REMS Pull 2 L / M,** dry and wet extractors, see page 324

Additional accessories see page 310 – 311.



## Supply format

**REMS Simplex 2.** Robust, handy drilling stand for core drilling up to Ø 202 mm. Drill column made of rigid, unbendable square precision steel tube  $\varnothing$  50 mm, with extra narrow tolerance, for low-vibration guiding of the slide. Drilling column guided in sturdy stand and double bolted for high rigidity during drilling. Steel section stand. 4 Set screws for levelling unevenness of the floor, for exact standing position. Clamping bracket for holding drive machines with clamping throat  $\varnothing$  60 mm. Slide guided on all sides by adjustable, pretensioned plastic slide bearings. Precision in-feed drive ensures easy, low-vibration drilling and precise, low-vibration drill thrust. For high thrust pressure and long life of the drilling crowns. Spirit level integrated in the slide for exact alignment of the drill stand. Locking of the slide for simple assembly of the drilling crown and safe transport. Stable clamping bracket, unbendable and rigid, for accommodating drive units with  $\varnothing$  60 mm clamping throat. Rack and pinion force transmission with ergonomically designed pressing lever which can be inserted in both sides of the slide. Wide steel rack Weight 12 kg.

With tools comprising Allen key size 6, single open ended wrench size SW 19 and SW 30 and fastening kit for masonry and concrete, consisting of 2 M12 splaying anchors, 10 M12 hammer anchors for concrete, setting iron for M12 hammer anchors, cord threaded bar M12  $\times$  52, quick clamping nut, washer, carbide masonry drill  $\varnothing$  15 mm SDS-plus in box.

For REMS Picus S1, REMS Picus S3, REMS Picus SR, REMS Picus DP and other makes.

	Art.-No.	€
	183700R	<b>1.017,24</b>



## Supply format

**REMS Titan.** Robust, highly stable drilling stand for core drilling in steel-reinforced concrete and other materials up to Ø 300 mm. For high demands. Drill column made of rigid, unbendable square precision steel tube  $\varnothing$  50 mm, with extra narrow tolerance, for low-vibration guiding of the slide. Continuously tiltable with degree scale up to 45°, with double support by adjustable, single-part steel girders, for maximum thrust pressure. Highly stable, 3-sided guidance of the drill column in the base plate and triple cross fastening for high rigidity in vertical drilling. 4 Eyebolts for levelling unevenness of the floor, for exact standing position. Drill depth scale. Slide guided on all sides by adjustable, pretensioned plastic slide bearings. Precision in-feed drive ensures easy, low-vibration drilling and precise, low-vibration drill thrust. For high thrust pressure and long life of the drilling crowns. Spirit level integrated in the slide for exact alignment of the drill stand. Locking of the slide for simple assembly of the drilling crown and safe transport. Rigid connection plate made of wear-resistant spheroidal iron. Quick-clamping device for accommodating drive units with a suitable connection plate. Highly stable clamping bracket, unbendable and rigid, for accommodating drive units with  $\varnothing$  60 mm clamping throat. Rack and pinion force transmission with ergonomically designed pressing lever which can be inserted in both sides of the slide. Wide steel rack. Base plate with groove for sealing ring of the vacuum fastening. Vacuum fastening as accessory. Drill column with adjustable clamping head for clamping the drill stand between the ceiling and floor or between two walls. Mobile drill stand for easy transport Weight 19,5 kg.

With tools comprising Allen key size 6, single open ended wrench size SW 19 and SW 30 and fastening kit for masonry and concrete, consisting of 2 M12 splaying anchors, 10 M12 hammer anchors for concrete, setting iron for M12 hammer anchors, cord threaded bar M12  $\times$  52, quick clamping nut, washer, carbide masonry drill  $\varnothing$  15 mm SDS-plus in box.

System advantage: For REMS Picus S1, REMS Picus S3, REMS Picus SR, REMS Picus S2/3,5, REMS Picus DP and other makes. Use spacer set (see below) when using with REMS Picus SR.

	Art.-No.	€
	183600R	<b>1.546,62</b>



Description	Art.-No.	€
<b>Spacer set</b> for additional stabilisation of the REMS Picus SR drive unit on the REMS Titan drill stand, consisting of spacer and 2 cylinder head screws M 8 $\times$ 65	183632R	<b>48,58</b>



# Accessories

For REMS Picus S1, REMS Picus S3, REMS Picus SR,  
REMS Picus S2/3,5 and other makes

Description	Art.-No.	€
<b>Water pressure tank</b> for 10 ltr of water, for wet drilling without water connection	182006R	<b>205,52</b>
<b>Titan drilling template</b> for easy setting of the fastening holes. For REMS Titan drilling stand.	183605R	<b>57,61</b>
<b>Carbide masonry drills Ø 15 mm SDS-plus</b> for hammer anchors M12	079018	<b>28,13</b>
<b>Hammer anchor M12 (pack of 50)</b> , for concrete	079005R50	<b>109,82</b>
<b>Setting iron for hammer anchor M12</b>	182050R	<b>16,09</b>
<b>Carbide masonry drill Ø 20 mm SDS-plus</b> for splaying anchors M12	079019	<b>63,42</b>
<b>Splaying anchor M12 (pack of 10)</b> , for masonry, reusable	079006R10	<b>102,76</b>
<b>Quick clamping set 160</b> for fastening the drilling stand with anchors, consisting of cord threaded bar 160 mm with M12 x 52 thread, quick clamping nut, washer.	079010	<b>72,76</b>
<b>Quick clamping set 500</b> for fastening the drilling stand without anchor, consisting of cord threaded bar 500 mm, 2 quick clamping nuts, 2 washers	183607R	<b>54,08</b>
<b>Titan vacuum fastening</b> , consisting of cover plate with nipple for 3/8" screw connection and sealing ring for base plate.	183603R	<b>99,44</b>
<b>Vacuum pump</b> , for vacuum ≤ -900 mbar (90%), consisting of dry running rotary slide pump, oil-free, performance 6 m <sup>3</sup> /h, condenser motor 230 V, 50-60 Hz, 250 W, splash water-protected, inside suction filter with silencer function and 5 m PVC fabric hose with bayonet coupling.	183670R220	<b>1.909,92</b>
<b>Laser drilling centre pointer</b>	183604R	<b>129,75</b>
<b>Drilling start aid G 1/2 UDKB</b> , with bores for extracting the drilling dust from the bore hole by a suction rotor for dust extraction (Art. No. 180160 R), with carbide masonry drill Ø 8 mm	180140R	<b>91,97</b>
<b>Carbide masonry drill Ø 8 mm</b> for drilling aid	079013	<b>18,89</b>
<b>Single open ended wrench size 41</b> for loosening the universal diamond core drilling crowns	079003	<b>38,35</b>
<b>Light loosening ring</b> , for light loosening of the diamond core crown	180015	<b>20,66</b>
<b>Drilling crown extension 200 mm</b>	180155R	<b>61,19</b>
<b>Sharpening stone</b> for diamond core drilling crowns	079012	<b>64,67</b>
<b>Circular spirit level</b> , magnetic, for aligning the drill stand	182010R	<b>75,26</b>
<b>Suction rotor for dust extraction</b> with G 1/2 male connecting thread, UNC 1 1/4 male connecting thread and with connection for REMS Pull 2 and other suitable extractors.	180160R	<b>173,35</b>
<b>Water suction device</b> , for wet drilling up to Ø 170 mm, consisting of water collection ring with pressure ring, rubber washer Ø 200 mm and universal pressure pad for all REMS drilling stands.	183606R	<b>393,40</b>
<b>Rubber washer Ø 200 mm (pack of 10)</b> , for water suction device	183675R10	<b>74,53</b>
<b>REMS Pull 2 L / M</b> , dry and wet extractor, certified as extractor and dust extractor for extracting health hazardous dusts in accordance with EN 60335-2-69, see page 324		

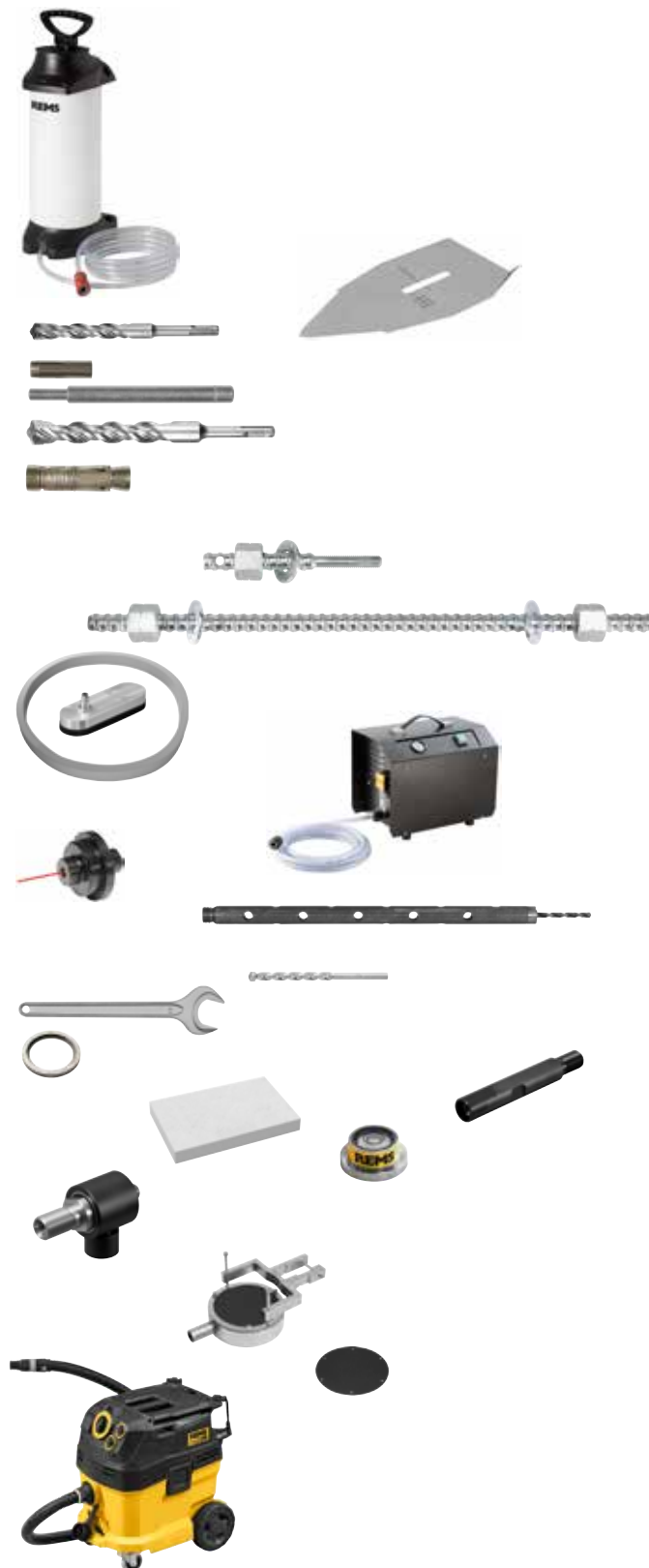

## REMS Universal diamond core drilling crowns

For REMS Picus S1, REMS Picus SR, REMS Picus S3, REMS Picus S2/3,5 and other makes

High quality universal diamond core drilling crowns. Inductively soldered. Universally usable for dry and wet drilling, hand held or with drill stand. Ideal for universal applications in steel-reinforced concrete, masonry and many types of material. For installation, metalwork, industry.

Concrete, steel-reinforced concrete, all kinds of masonry, natural stone, asphalt, all kinds of screed and other      Ø 32 – 300 mm

### REMS Universal diamond core drilling crowns – Inductively soldered. Diamond segments with conical cut for fast, easy and quiet drilling. Versatile for many types of material. Ideal for plumbers.

Universally usable for many materials, for dry and wet drilling, hand held or with drill stand.

Single connecting thread UNC 1¼ female. Drilling depth 420 mm.

Specially developed, high quality diamond segments with high diamond percentage and special bonding, for excellent drilling performance and very long life. Ideal for universal applications in steel-reinforced concrete and masonry.

Diamond segments with conical cut ("roof shape") for fast, easy and quiet drilling. Inductively soldered on fully automatic soldering machines for constant high quality of the soldered connection. Drilling tubes with soldered diamond segments can be resoldered by simple hard soldering.

Light loosening ring, for light loosening of the diamond core crowns, as accessory.

Drive through all REMS Picus drive machines and suitable drive machines of other makes having connecting thread UNC 1¼ male. Adapter for using REMS Universal diamond core drilling crowns in drive machines having other connecting threads/other tool holders, as accessory.

Suck off dusts that occur during dry drilling with REMS Pull 2 M safety vacuum cleaner, certified for extracting health hazardous dusts of dust class M (page 324).



Info



# REMS Universal diamond core drilling crowns

For REMS Picus S1, REMS Picus SR, REMS Picus S3, REMS Picus S2/3,5 and other makes

## Supply format

**REMS Universal diamond core drilling crown.** Inductively soldered, resolderable. Universally usable for dry and wet drilling, hand held or with drill stand. For many materials, e.g. concrete, steel-reinforced concrete, all kinds of masonry, natural stone, asphalt, all kinds of screed. Connecting thread UNC 1 1/4 female. Drilling depth 420 mm. In a carton.

Ø × drilling depth × connection	Number of segments	Art.-No.	€
UDKB 32 × 420 × UNC 1 1/4	4	181010R	143,19
UDKB 42 × 420 × UNC 1 1/4	4	181015R	133,85
UDKB 52 × 420 × UNC 1 1/4	5	181020R	142,15
UDKB 62 × 420 × UNC 1 1/4	6	181025R	154,61
UDKB 72 × 420 × UNC 1 1/4	7	181030R	175,37
UDKB 82 × 420 × UNC 1 1/4	7	181035R	189,90
UDKB 92 × 420 × UNC 1 1/4	8	181040R	214,81
UDKB 102 × 420 × UNC 1 1/4	8	181045R	220,00
UDKB 112 × 420 × UNC 1 1/4	9	181050R	232,46
UDKB 122 × 420 × UNC 1 1/4	10	181055R	262,56
UDKB 127 × 420 × UNC 1 1/4	10	181059R	272,94
UDKB 132 × 420 × UNC 1 1/4	11	181060R	284,36
UDKB 152 × 420 × UNC 1 1/4	12	181065R	338,34
UDKB 162 × 420 × UNC 1 1/4	12	181070R	358,06
UDKB 182 × 420 × UNC 1 1/4	12	181075R	396,46
UDKB 200 × 420 × UNC 1 1/4	12	181080R	419,30
UDKB 225 × 420 × UNC 1 1/4	13	181085R	510,64
UDKB 250 × 420 × UNC 1 1/4	14	181090R	524,14
UDKB 300 × 420 × UNC 1 1/4	22	181095R	686,07



## Accessories

Description	Art.-No.	€
<b>Light loosening ring</b> , for light loosening of the diamond core crown	180015	20,66
<b>Drilling crown extension 200 mm</b>	180155R	61,19
<b>Adapter UNC 1 1/4 male to G 1/2 male</b>	180052	31,45
<b>Adapter UNC 1 1/4 male to G 1/2 female</b>	180056	28,55
<b>Adapter UNC 1 1/4 male for Hilti BI</b> , adapter for using the REMS universal diamond core drilling crowns in Hilti drive machines with BI tool holder.	180053	48,27
<b>Adapter UNC 1 1/4 male for Hilti BU</b> , adapter for using the REMS universal diamond core drilling crowns in Hilti drive machines with BU tool holder.	180054	111,07
<b>Adapter UNC 1 1/4 male for Hilti BL</b> , adapter for using the REMS universal diamond core drilling crowns in Hilti drive machines with BL tool holder.	180057R	111,07
<b>Sharpening stone</b> for diamond core drilling crowns	079012	64,67
<b>Single open ended wrench size 41</b> for UDKB	079003	38,35

Additional adapters for using REMS Universal diamond core drilling crowns in drive machines of other makes, on request.



## REMS Universal diamond core drilling crowns LS

For REMS Picus S1, REMS Picus SR, REMS Picus S3, REMS Picus S2/3,5 and other makes

High quality universal diamond core drilling crowns. Laser welded. Universally usable for dry and wet drilling, hand held or with drill stand. Ideal for universal applications in steel-reinforced concrete, masonry and many types of material. For installation, metalwork, industry.

Concrete, steel-reinforced concrete, all kinds of masonry, natural stone, asphalt, all kinds of screed and other      Ø 32–200 mm

### REMS universal diamond core drilling crowns LS – laser welded. Diamond segments with conical cut for fast, easy and quiet drilling. Versatile for many types of material. Ideal for plumbers.

Universally usable for many materials, for dry and wet drilling, hand held or with drill stand.

Single connecting thread UNC 1¼ female. Drilling depth 420 mm.

Specially developed, high quality diamond segments with high diamond percentage and special bonding, for excellent drilling performance and very long life. Ideal for universal applications in steel-reinforced concrete and masonry.

Diamond segments with conical cut ("roof shape") for fast, easy and quiet drilling. Inductively soldered on fully automatic soldering machines for constant high quality of the soldered connection. Drilling tubes with soldered diamond segments can be resoldered by simple hard soldering.

Light loosening ring, for light loosening of the diamond core crowns, as accessory.

Drive through all REMS Picus drive machines and suitable drive machines of other makes having connecting thread UNC 1¼ male. Adapter for using REMS Universal diamond core drilling crowns in drive machines having other connecting threads/other tool holders, as accessory.

Suck off dusts that occur during dry drilling with REMS Pull 2 M safety vacuum cleaner, certified for extracting health hazardous dusts of dust class M (page 324).

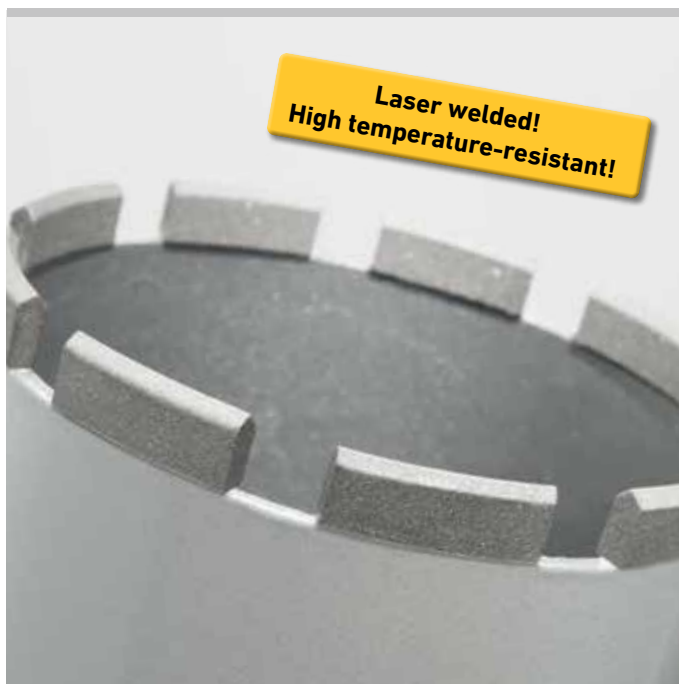

Info

# REMS Universal diamond core drilling crowns LS

For REMS Picus S1, REMS Picus SR, REMS Picus S3, REMS Picus S2/3,5 and other makes

## Supply format

**REMS Universal diamond core drilling crown.** Laser welded! High temperature-resistant! Universally usable for dry and wet drilling, hand held or with drill stand. For many materials, e.g. concrete, steel-reinforced concrete, all kinds of masonry, natural stone, asphalt, all kinds of screed. Connecting thread UNC 1 1/4 female. Drilling depth 420 mm. In a carton.

Ø × drilling depth × connection	Number of segments	Art.-No.	€
UDKB LS 32 × 420 × UNC 1 1/4	1	181410R	157,72
UDKB LS 42 × 420 × UNC 1 1/4	4	181415R	147,34
UDKB LS 52 × 420 × UNC 1 1/4	5	181420R	156,69
UDKB LS 62 × 420 × UNC 1 1/4	6	181425R	170,18
UDKB LS 72 × 420 × UNC 1 1/4	6	181430R	193,02
UDKB LS 82 × 420 × UNC 1 1/4	7	181435R	209,62
UDKB LS 92 × 420 × UNC 1 1/4	8	181440R	236,61
UDKB LS 102 × 420 × UNC 1 1/4	9	181445R	242,84
UDKB LS 112 × 420 × UNC 1 1/4	9	181450R	256,33
UDKB LS 122 × 420 × UNC 1 1/4	10	181455R	289,55
UDKB LS 127 × 420 × UNC 1 1/4	10	181459R	300,97
UDKB LS 132 × 420 × UNC 1 1/4	10	181460R	313,42
UDKB LS 152 × 420 × UNC 1 1/4	11	181465R	372,59
UDKB LS 162 × 420 × UNC 1 1/4	12	181470R	394,39
UDKB LS 182 × 420 × UNC 1 1/4	13	181475R	476,39
UDKB LS 200 × 420 × UNC 1 1/4	14	181480R	503,38

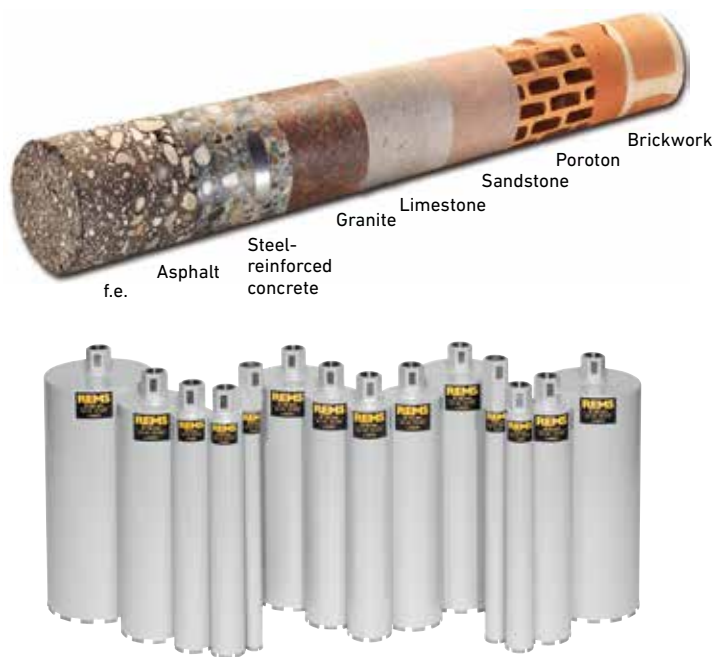

## Accessories

Description	Art.-No.	€
<b>Light loosening ring</b> , for light loosening of the diamond core crown	180015	20,66
<b>Drilling crown extension 200 mm</b>	180155R	61,19
<b>Adapter UNC 1 1/4 male to G 1/2 male</b>	180052	31,45
<b>Adapter UNC 1 1/4 male to G 1/2 female</b>	180056	28,55
<b>Adapter UNC 1 1/4 male for Hilti BI</b> , adapter for using the REMS universal diamond core drilling crowns in Hilti drive machines with BI tool holder.	180053	48,27
<b>Adapter UNC 1 1/4 male for Hilti BU</b> , adapter for using the REMS universal diamond core drilling crowns in Hilti drive machines with BU tool holder.	180054	111,07
<b>Adapter UNC 1 1/4 male for Hilti BL</b> , adapter for using the REMS universal diamond core drilling crowns in Hilti drive machines with BL tool holder.	180057R	111,07
<b>Sharpening stone</b> for diamond core drilling crowns	079012	64,67
<b>Single open ended wrench size 41</b> for UDKB	079003	38,35

Additional adapters for using REMS Universal diamond core drilling crowns in drive machines of other makes, on request.



# REMS Picus DP

Electric diamond core drilling machine  
with micro-pulse technology

Compact, handy power tool for core drilling, e.g. in concrete, steel-reinforced concrete, all kinds of masonry, natural stone, asphalt, all kinds of screed. With micro-pulse technology. Especially for dry drilling, hand held or with drill stand. For trade and industry.

Concrete, steel-reinforced concrete ≤ Ø 162 (202) mm

Masonry and other materials ≤ Ø 202 mm

REMS dry diamond core drilling crowns, also suitable for drive machines of other makes, see page 319.

## REMS Picus DP – with micro-pulse technology

**For core drilling without water. Clean, easy, fast, e.g. 200 mm in steel-reinforced concrete Ø 62 mm in only 5 min.**

### Especially for dry drilling

Drive machine with micro-pulse technology, specially developed for dry drilling, hand held or with drill stand. Can be used anywhere, in narrow angles, flush with the wall. Suitable for many, especially hard materials. For pipeline and cable ducting, ventilation channels, test core drilling. In combination with the REMS Pull 2 M vacuum cleaner, ideal for making core bores in finished rooms, e.g. in residential, office and industrial buildings.

### Design

Compact, handy drive machine for low-vibration core drilling, with drilling crown connecting thread UNC 1 ¼ male, BSPP ½ female. Compact drive unit for low-vibration core drilling, with drilling crown connecting thread UNC 1 ¼ outside, G ½ inside. Micro-pulse technology can be switched on and off: Pulse disc with 24 teeth generates 28,800 pulses min<sup>-1</sup> in idle mode at 1,200 min<sup>-1</sup>, under load at 880 min<sup>-1</sup> 21,120 pulses min<sup>-1</sup>. Robust, suitable for the building site. Extra light, only 7 kg. Simple, fast work without water, e.g. 200 mm in steel-reinforced concrete Ø 62 mm in only 5 min. Practical spade handle and stabiliser for hand held drilling. Integrated suction rotor for dust extraction with connection for REMS Pull 2 M and other suitable vacuum cleaners. Throat Ø 60 mm for holding the drive machine in the drill stand.

### Drive

Robust, powerful 2200 W universal motor. Load speed drilling spindle 8080 rpm. Stable, maintenance-free gear. Blocking protection by safety slip clutch. Tip switch with lock. Connecting cable with integrated personal protection switch (PRCD).

### Multifunction electronics

Multifunction electronics with start-up current limiting for soft starting for delicate drilling start, automatic idle speed limiting for noise reduction and preservation of the motor, overload and blocking protection for motor and gear.

### Dry diamond core drilling crowns LS

Especially for dry drilling with core drilling machines with micro-pulse technology, laser welded, high temperature-resistant (page 319), for drilling without water, hand held or with drill stand. Connecting thread UNC 1 ¼ female. Drilling depth 320 mm. Specially developed, high quality diamond segments with high diamond percentage and special bonding, for excellent drilling performance and very long life. Ideal for dry drilling in steel-reinforced concrete and masonry. Light loosening ring, for light loosening of the dry diamond core drilling crown, as accessory.

### Dust extraction in accordance with EN 60335-2-69

When working with mineral building materials, e.g. concrete, steel-reinforced concrete, masonry and screed, a high degree of mineral dust containing quartz is produced which is harmful to the health. Inhalation of quartz fine dust is harmful to the health. EN 60335-2-69 prescribes the use of at least one safety extractor of dust class M for the extraction of health hazardous dusts with an exposure limit/work place limit of > 0.1 mg/m<sup>3</sup>. Observe the national regulations.

Use REMS Pull 2 M for high-performance extraction of drilling dusts from the drilling gap during dry drilling (page 324). The REMS Pull 2 M safety vacuum cleaner is certified for extracting health hazardous dusts of dust class M.

### Drilling start aid

Drilling start aid G ½ TDKB, with bores for extracting the drilling dust from the bore hole, with carbide masonry drill Ø 8 mm.

### Drill stand

REMS Simplex 2 or REMS Titan drill stands can be used optionally (page 318).



German Quality Product



Info



REMS Simplex 2



REMS Titan



REMS Picus DP Basic-Pack



REMS Picus DP Set Simplex 2



REMS Picus DP Set Titan



REMS Picus DP/Pull 2 M Set-Pack

### Supply format

**REMS Picus DP Basic-Pack.** Electric diamond core drilling machine with micro-pulse technology for core drilling without water in concrete, steel-reinforced concrete  $\leq \varnothing 162$  (202) mm, masonry and other materials  $\leq \varnothing 202$  mm, hand held or with drill stand. Drive unit with drilling crown male connection thread UNC 1¼, female connection thread G ½, maintenance-free gear with safety slip clutch, 110 V / 230 V, 50–60 Hz, 2200 W universal motor, integrated dust extraction. Multifunction electronics with soft starting, idle speed limiting, overload protection, blocking protection. Touch switch with lock. Load speed drilling spindle 880 rpm. Stabiliser. Drill start aid G ½ TDKB with  $\varnothing 8$  mm drill, size 3 Allen key. Size 32 opened ended wrench. In sturdy steel case.

	Art.-No.	€
	180016R220	<b>2.584,62</b>

Other voltages on request.

### Supply format

**REMS Picus DP Set Simplex 2.** REMS Picus DP Basic-Pack with REMS Simplex 2 drilling stand including tools and fastening kit for masonry and concrete.

	Art.-No.	€
	180033R220	<b>3.601,86</b>

Other voltages on request.

### Supply format

**REMS Picus DP Set Titan.** REMS Picus DP Basic-Pack with REMS Titan drilling stand including tools and fastening kit for masonry and concrete.

	Art.-No.	€
	180035R220	<b>4.131,24</b>

Other voltages on request.

### Supply format

**REMS Picus DP/Pull 2 M Set-Pack.** REMS Picus DP Basic-Pack, Art.-No. 180016 R110G, and REMS Pull 2 M Set, Art.-No. 185601 R220G.

	Art.-No.	€
	180036R220	<b>3.652,72</b>

Other voltages on request.

### Accessories

Description	Art.-No.	€
<b>REMS Picus DP drive unit</b>	180003R220	<b>2.532,72</b>
<b>Steel case with inlay</b>	180600R	<b>128,71</b>
<b>REMS dry diamond core drilling crowns LS,</b> laser welded, high temperature-resistant, see page 319.		
<b>REMS Pull 2 M,</b> dry and wet extractor, see page 324		
Additional accessories see page 318.		



Description	Art.-No.	€
<b>REMS Simplex 2.</b> Robust, handy drilling stand for core drilling up to Ø 202 mm. Description see page 310.	183700R	<b>1.017,24</b>
<b>REMS Titan.</b> Robust, highly stable drilling stand for core drilling in steel-reinforced concrete and other materials up to Ø 300 mm. For high demands. Description see page 310.	183600R	<b>1.546,62</b>
<b>Titan drilling template</b> for easy setting of the fastening holes. For REMS Titan drilling stand.	183605R	<b>57,61</b>
<b>Carbide masonry drills Ø 15 mm SDS-plus</b> for hammer anchors M12	079018	<b>28,13</b>
<b>Hammer anchor M12 (pack of 50)</b> , for concrete	079005R50	<b>109,82</b>
<b>Setting iron for hammer anchor M12</b>	182050R	<b>16,09</b>
<b>Carbide masonry drill Ø 20 mm SDS-plus</b> for splaying anchors M12	079019	<b>63,42</b>
<b>Splaying anchor M12 (pack of 10)</b> , for masonry, reusable	079006R10	<b>102,76</b>
<b>Quick clamping set 160</b> for fastening the drilling stand with anchors, consisting of cord threaded bar 160 mm with M12 × 52 thread, quick clamping nut, washer.	079010	<b>72,76</b>
<b>Quick clamping set 500</b> for fastening the drilling stand without anchor, consisting of cord threaded bar 500 mm, 2 quick clamping nuts, 2 washers	183607R	<b>54,08</b>
<b>Titan vacuum fastening</b> , consisting of cover plate with nipple for ¾" screw connection and sealing ring for base plate.	183603R	<b>99,44</b>
<b>Vacuum pump</b> , for vacuum ≤ -900 mbar (90%), consisting of dry running rotary slide pump, oil-free, performance 6 m <sup>3</sup> /h, condenser motor 230 V, 50–60 Hz, 250 W, splash water-protected, inside suction filter with silencer function and 5 m PVC fabric hose with bayonet coupling.	183670R220	<b>1.909,92</b>
<b>Laser drilling centre pointer</b>	183604R	<b>129,75</b>
<b>Drilling start aid G ½ TDKB</b> , with bores for extracting the drilling dust from the bore hole, with carbide masonry drill Ø 8 mm	180145R	<b>91,97</b>
<b>Carbide masonry drill Ø 8 mm</b> for drilling aid	079013	<b>18,89</b>
<b>Single open ended wrench size 41</b> for loosening the universal diamond core drilling crowns	079003	<b>38,35</b>
<b>Light loosening ring</b> , for light loosening of the diamond core crown	180015	<b>20,66</b>
<b>Drilling crown extension 200 mm</b>	180155R	<b>61,19</b>
<b>Sharpening stone</b> for diamond core drilling crowns	079012	<b>64,67</b>
<b>Circular spirit level</b> , magnetic, for aligning the drill stand	182010R	<b>75,26</b>
<b>REMS Pull 2 M</b> , dry and wet extractor, certified as extractor and dust extractor for extracting health hazardous dusts in accordance with EN 60335-2-69, see page 324		



## REMS dry diamond core drilling crowns LS

For REMS Picus DP and other suitable makes

High quality dry diamond core drilling crowns. Laser welded. Especially for dry drilling with core drilling machines with micro-pulse technology, e.g. REMS Picus DP, hand held or with drill stand. Ideal for universal applications in steel-reinforced concrete, masonry and many types of material.

Concrete, steel-reinforced concrete, aggregate concrete, brick, clinker, all kinds of masonry, natural stone, asphalt, all kinds of screed and other  $\varnothing$  32 – 202 mm

### REMS dry diamond core drilling crowns LS – Laser welded, high temperature-resistant. Especially for dry drilling with core drilling machines with micro-pulse technology. Versatile for many types of material. Ideal for plumbers.

Universally usable for many materials, hand held or with drill stand.

Single connecting thread UNC 1 1/4 female. Drilling depth 320 mm.

Specially developed, high quality diamond segments with high diamond percentage and special bonding, for excellent drilling performance and very long life. Ideal for universal applications in steel-reinforced concrete and masonry.

Diamond segments with diamonds positioned in the bonding agent. For fast, easy and quiet drilling. Inductively soldered on fully automatic soldering machines for constant high quality of the soldered connection. Drilling tubes with soldered diamond segments can be resoldered by simple hard soldering.

Light loosening ring, for light loosening of the diamond core crowns, as accessory.

Driven by a REMS Picus DP drive unit and suitable drive units of other makes with UNC 1 1/4 outer connecting thread.

Use REMS Pull 2 M for high-performance extraction of drilling dusts from the drilling gap during dry drilling (page 324). The REMS Pull 2 M safety vacuum cleaner is certified for extracting health hazardous dusts of dust class M.

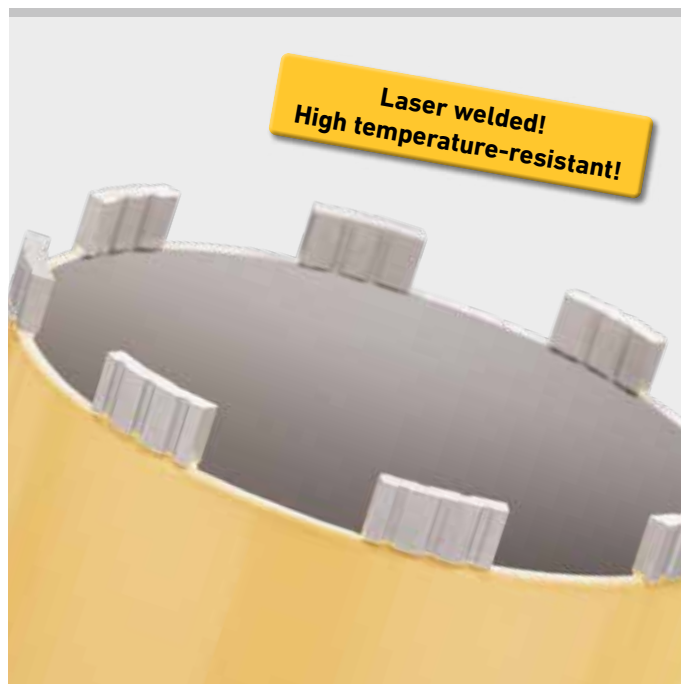

### Supply format

REMS dry diamond core drilling crowns LS. Laser welded, high temperature-resistant. Especially for dry drilling with core drilling machines with micro-pulse technology, e.g. REMS Picus DP, hand held or with drill stand. For many materials, e.g. concrete, steel-reinforced concrete, all kinds of masonry, natural stone, asphalt, all kinds of screed. Connecting thread UNC 1 1/4 female. Drilling depth 320 mm. In a carton.

$\varnothing$ x drilling depth x connection	Number of segments	Art.-No.	€
TDKB LS 32 x 320 x UNC 1 1/4	3	181500R	172,26
TDKB LS 42 x 320 x UNC 1 1/4	4	181502R	160,84
TDKB LS 52 x 320 x UNC 1 1/4	5	181504R	171,22
TDKB LS 62 x 320 x UNC 1 1/4	5	181506R	186,79
TDKB LS 72 x 320 x UNC 1 1/4	6	181508R	211,70
TDKB LS 82 x 320 x UNC 1 1/4	6	181510R	229,35
TDKB LS 92 x 320 x UNC 1 1/4	6	181512R	258,41
TDKB LS 102 x 320 x UNC 1 1/4	7	181514R	264,64
TDKB LS 112 x 320 x UNC 1 1/4	7	181516R	279,17
TDKB LS 122 x 320 x UNC 1 1/4	8	181532R	320,69
TDKB LS 127 x 320 x UNC 1 1/4	8	181518R	332,11
TDKB LS 132 x 320 x UNC 1 1/4	8	181520R	341,45
TDKB LS 142 x 320 x UNC 1 1/4	8	181522R	365,32
TDKB LS 152 x 320 x UNC 1 1/4	8	181524R	406,84
TDKB LS 162 x 320 x UNC 1 1/4	9	181526R	431,76
TDKB LS 182 x 320 x UNC 1 1/4	9	181528R	476,39
TDKB LS 202 x 320 x UNC 1 1/4	10	181530R	504,42



### Accessories

Description	Art.-No.	€
Light loosening ring, for light loosening of the diamond core crown	180015	20,66
Drilling crown extension 200 mm	180155R	61,19
Sharpening stone for diamond core drilling crowns	079012	64,67
Single open ended wrench size 41 for UDKB	079003	38,35

Additional adapters for using REMS dry diamond core drilling crowns LS in drive machines of other makes, on request.



Diamond tipped dry drilling crowns for fast, clean drilling in all kinds of tiles. Ideal for assembly and renovation.

Ceramic, fine clay, granite, marble etc.

## REMS tile drilling – for dry drilling.

Can be used universally for dry drilling without hammering in ceramic, fine clay, granite, marble and other materials. No cracking of the tiles.

No water necessary.

Special wax filling inside the dry drilling crown as a cooling lubricant, becomes liquid when heated and cools the dry drilling crown.

Simple, free-hand starting by drill aid with vacuum fastening.

Hexagon connection for 1/4" bit holders.

Drive by cordless REMS Helix 22 V VE power drill (page 108) and other electric drills/screwdrivers (speed ≥ 1,000 rpm).



## Supply format

**REMS tile drilling Set 6 + 8 + 10.** Diamond-studded dry drilling crowns with special wax filling. For ceramic, fine clay, granite, marble and other materials. Tile drilling Ø 6, 8, 10 mm, drill aid with vacuum fastening. In blister pack.

	Art.-No.	€
	181700R	<b>206,56</b>

## Accessories

Description	Art.-No.	€
<b>REMS tile drilling Ø 5 mm</b>	181710R	<b>50,81</b>
<b>REMS tile drilling Ø 6 mm</b>	181711R	<b>50,81</b>
<b>REMS tile drilling Ø 8 mm</b>	181712R	<b>51,85</b>
<b>REMS tile drilling Ø 10 mm</b>	181713R	<b>52,89</b>
<b>REMS tile drilling Ø 12 mm</b>	181714R	<b>57,04</b>
<b>REMS tile drilling Ø 14 mm</b>	181715R	<b>82,99</b>

REMS Helix 22 V VE, cordless drill/screwdriver, see page 108







Compact, handy power tool for dry chasing and cutting, e.g. of concrete, steel-reinforced concrete, all kinds of masonry, natural stone, all kinds of screed. For trade and industry.

Chase depth	≤ 61 mm
Chase width	≤ 62 mm
Number of diamond cutting discs	1 – 3

REMS Universal diamond cutting discs, also for suitable drive machines of other makes, see page 323.

### REMS Krokodil 180 SR – chasing instead of chiselling. Full contact support plate. Multi-function electronics.

#### Universal use

Universal drive machine for dry chasing and cutting. Ideal for producing chases/grooves for laying pipes and electric cables in heating, sanitary and electrical installation, air-conditioning and cooling technology.

#### Design

Compact, handy drive machine, only 8.0 kg. Robust, suitable for building site conditions. Fast, easy working, e.g. chases in masonry 500 mm long, 61 mm deep, only 34 s. Full contact support plate during the entire chasing/cutting process for guided plunge-in of the diamond cutting discs, dust-free, safe working and easy, even feed. Practical switch handle with triple force-transmitting leverage for easy plunge-in and effective feeding. Swivel handle, for optimum working position and ergonomic work. Locking of the drive shaft for easy changing of the universal diamond cutting discs. Spacer discs of different thicknesses according to desired chase width screws to the cutting discs in a stable block, ensure an even chase width. Continuously adjustable depth stop. Suction nozzle for connecting a dust extractor integrated into the housing.

#### Drive

Robust, powerful universal motor, 2,000 W. Load speed of the drive shaft of the cutting discs 3,300 rpm. Overheating protection by temperature monitoring of the motor's field winding with a PTC resistor (Positive Temperature Coefficient). Strong, maintenance-free gear. Connecting cable 5.7 m. Safety switch with lock. Restart protection in case of mains failure.

#### Speed Regulation

The electronic tachometer speed control used for regulation keeps the speed constant, also under load. The speed of the cutting disc is kept at the nominal value until it meets with resistance and drops below a critical value. The drive motor stops. When the load on the drive unit is relieved again, the drill runs back up to nominal speed so that work can continue immediately at nominal speed (**Patent EP 2 085 191**). Advantage: The chasing and cutting speed (load speed) is maintained during the entire chasing and cutting process for a high chasing and cutting performance.

#### Multi-function electronics

Multifunction electronics with start-up current limiting for soft starting for delicate engagement of the diamond cutting discs, automatic idle speed limiting for noise reduction and preservation of the motor, overload and blocking protection for motor and gear.

#### Universal diamond cutting discs

Universally usable for straight chasing and cutting. Specially developed, high quality diamond segments with high diamond content and special bonding for excellent chasing/drilling performance and very long life. Optionally REMS Universal diamond cutting discs LS Turbo, laser-welded, high temperature-resistant, for fast cuts and cuts in hard materials or REMS Universal diamond cutting discs LS H-P, high-performance, laser-welded, high temperature-resistant, for fast cuts and cuts in very hard materials, with long life (page 323), metal body in accordance with EN 13236. Mounting bore  $\varnothing$  22.23 mm.

#### Dust extraction in accordance with EN 60335-2-69

When working with mineral building materials, e.g. concrete, steel-reinforced concrete, masonry and screed, a high degree of mineral dust containing quartz is produced which is harmful to the health. Inhalation of quartz fine dust is harmful to the health. EN 60335-2-69 prescribes the use of at least one safety extractor of dust class M for the extraction of health hazardous dusts with an exposure limit/work place limit of  $> 0.1 \text{ mg/m}^3$ ). Observe the national regulations. REMS Pull 2 M, wet and dry dust extractor, certified for extracting health hazardous dusts of dust class M (page 324).



Full contact support plate during the entire chasing/cutting process for guided plunge-in of the diamondcutting discs, dust-free, safe working and easy, even feed.

## Supply format

**REMS Krokodil 180 SR Basic-Pack.** Electric diamond chasing and cutting grinder with speed regulation. For chasing and cutting concrete, steel-reinforced concrete, all kinds of masonry, natural stone, all kinds of screed. Chase depth 61 mm, continuously adjustable. Chase width ≤ 62 mm, stepped with spacer discs 3, 6, 10, 20 mm. Drive machine with drive shaft Ø 22.2 mm, for 1, 2 or 3 diamond cutting discs in accordance with EN 13236, ≤ Ø 180 mm, with maintenance-free gear, 230 V, 50 – 60 Hz, 2,000 W universal motor. Multifunction electronics with soft start, idling speed limiting, overload protection, overheating protection. Restart protection in case of mains failure. Connecting cable 5.7 m. Safety switch with lock. Load speed 3,300 rpm. Suction nozzle for connecting an extractor/dust extractor. Pin wrench size 13. In sturdy steel case.

	Art.-No.	€
	185011R220	1.235,22

Other voltages on request.



Info



## Accessories

Description	Art.-No.	€
<b>REMS Krokodil 180 SR drive unit</b>	185001R220	1.183,32
<b>REMS Universal diamond cutting disc LS-Turbo Ø 180 mm</b> , laser-welded, high temperature-resistant, for fast cuts and cuts in very hard materials, with metal body in accordance with EN 13236	185026R	58,65
<b>REMS Universal diamond cutting disc LS H-P Ø 180 mm</b> , high-performance, laser-welded, high temperature-resistant, for fast cuts and cuts in very hard materials, long life, with metal body in accordance with EN 13236.	185027R	93,84
<b>Chasing chisel</b> for removing the ridge after chasing	185024R	25,22
<b>Steel case</b>	185058R	110,03
<b>REMS Pull 2 L / M</b> , dry and wet extractors, see page 324		



Powerful, electric dry and wet extractor with automatic filter cleaning. For commercial use in trade and industry.

For extraction of dusts, dirt and liquids.

Ideal for dust extracting when chasing, cutting, drilling, core drilling and grinding.

Certified as extractor and dust extractor for extracting health hazardous dusts.

Ideal for extracting drilling sludge during core drilling.

### REMS Pull 2 L

Dust class in accordance with EN 60335-2-69	L
Exposure limit/work place limit	> 1 mg/m <sup>3</sup>
Penetration level	≤ 0.1 %

### REMS Pull 2 M

Dust class in accordance with EN 60335-2-69	M
Exposure limit/work place limit	> 0.1 mg/m <sup>3</sup>
Penetration level	≤ 0.1 %

**REMS Pull 2 – for dry and wet suction.**  
**Constantly high suction performance**  
**by permanent automatic filter cleaning.**  
**Certified for extracting health hazardous dusts.**

### Universal use

Powerful, handy extractor for dry and wet suction. For extraction of dusts, dirt and liquids. Excellently suited for dust extracting when chasing, cutting, drilling, core drilling and grinding. Certified as an extractor and dust extractor for extracting health hazardous dusts of dust class L or M in accordance with EN 60335-2-69. For commercial use in trade and industry.

### Design

Compact, handy design. REMS Pull 2 L only 13.5 kg, REMS Pull 2 M only 14.2 kg. Light and manoeuvrable by rubber wheels and steerable castors, lockable by castor with brake. Large tank capacity 31 l, filling volume for liquids 17 l. On/Off switch with selection without filter cleaning or with filter cleaning with a 15 s or 60 s cycle. Adapter for connecting a power tool to the vacuum cleaner. Flexible 4 m, electrically conductive suction hose (Pull M), ergonomically angled handle, 2 pluggable, chrome-plated metal suction pipes 0.5 m for adapting the suction pipe length. Wide wet/dry surface attachment 300 mm with rubber-coated castors, optionally brush strips for extracting dusts and dirt or rubber lips for extracting liquids. Joint attachment for confined spaces. Large working radius by long 7.5 m connecting lead. Holders for connecting lead, suction hose, metal suction tubes and accessories integrated into the extractor. Practical handle for easy transport. Integrated fittings for fixing a REMS L-Boxx system case.

REMS Pull 2 M is suitable and certified for the extraction of health hazardous dusts of dust class M in accordance with EN 60335-2-69, with electronic flow monitoring, selector switch for adapting the suction power to different suction hose diameters (21, 27, 32, 35, 40 mm) and stopper for the suction hose connection nozzle.

### Permanent automatic filter cleaning

REMS Pull 2 L and REMS Pull 2 M with innovative, patented, automatic filter cleaning, prevents clogging of the filter with dust, especially effective in fine dust applications. The flat pleated filter is cleaned automatically by targeted, powerful shots of air every 15 s or 60 s depending on the setting. The suction force remains constantly high during cleaning. Patented flat folded filter system.

### Drive

Robust, powerful bypass motor, 1,200 W, with high-power turbine. High suction power, continuously adjustable up to an air rate ≤ 143 m<sup>3</sup>/h, for optimum adaptation to the suction surface and the extracted product.

### Automatic switch-off

Filling level limiting with automatic switch off on reaching the maximum liquid filling level when extracting electrically conductive liquids.

### Automatic power tool on/off

Appliance socket for power tools up to 2,200 W, with electronic automatic on/off integrated into the extractor. The extractor switches on/off automatically when the power tool is switched on/off. For convenient working.

### Anti-static system (REMS Pull 2 M)

Static charge is dissipated to the earthed upper section of the extractor by electrically conductive metal suction pipes, electrically conductive handle E, electrically conductive suction hose E and electrically conductive suction hose connection nozzle.



Certified extractor and dust extractor for extracting health hazardous dusts in accordance with EN 60335-2-69.



Extraction of health hazardous dusts when chasing and cutting:  
REMS Pull 2 M Set



Extraction of health hazardous dusts when dry drilling:  
REMS Pull 2 M Set D

### Dust extraction in accordance with EN 60335-2-69

When working with mineral building materials, e.g. concrete, steel-reinforced concrete, masonry and screed, a high degree of mineral dust containing quartz is produced which is harmful to the health. Inhalation of quartz fine dust is harmful to the health. EN 60335-2-69 prescribes the use of at least one safety extractor of dust class M for the extraction of health hazardous dusts with an exposure limit/work place limit of > 0.1 mg/m<sup>3</sup>. Observe the national regulations.

### Water extraction

PES flat folded filter required for extraction of water. Use wet filter bag or polythene bag if necessary. Wet filter bags separate the water from the sucked up solids when extracting dirty water. Polythene bags simplify disposal of the dirt and prevent dirt from collecting in the tank.



Extraction of drilling sludge when wet drilling with REMS drill stands:  
REMS Pull 2 L Set W

### Supply format

**REMS Pull 2 Set.** Electric dry and wet extractor for commercial use. For extraction of dusts, dirt and liquids. Ideal for dust extracting when chasing, cutting, drilling, core drilling and grinding. Certified extractor and dust extractor for extracting health hazardous dusts in accordance with EN 60335-2-69<sup>1)</sup>. Bypass motor 230 V, 50–60 Hz, 1,200 W. On/Off switch with selection for automatic filter cleaning. Suction power switch for continuous adjustment of the air flow ≤ 143 m<sup>3</sup>/h. Filling level limiting with automatic switch-off for wet suction. Automatic filter cleaning. Appliance socket for power tools up to 2,200 W, with electronic automatic on/off. Large tank capacity 31 l, filling volume for liquids 17 l. Mobile, 2 wheels, castor/castor with brake. Connecting cable 7.5 m. 1 felt filter bag, 1 flat pleated filter PES. Flat suction attachment wet/dry 300 mm with rollers, brush strips, rubber lips. Joint attachment. Pull 2 suction hose/power tool adapter. Integrated holders for connecting cable, suction hose and accessories. In a box.

Description	Version	Art.-No.	€
<b>Pull 2 L Set</b>	Dust class L. Exposure limit/work place limit > 1 mg/m <sup>3</sup> , penetration level ≤ 0.1 %, 2 metal suction pipes 0.5 m each, handle, 4 m suction hose, suction hose connection nozzle.	185600R220	<b>798,22</b>
<b>Pull 2 L Set W</b>	REMS Pull 2 L set with water suction device. Ideal for extraction of drilling sludge when wet drilling with REMS drill stands.	185603R220	<b>1.191,62</b>
<b>Pull 2 M Set</b>	Dust class M. Exposure limit/work place limit > 0.1 mg/m <sup>3</sup> , penetration level ≤ 0.1 %. Electronic volume flow monitor with acoustic signal. Selector switch for suction hose diameter. Stopper for the suction hose connection nozzle. Antistatic system with 2 electrically conductive metal suction pipes 0.5 m each, E handle, 4 m E suction hose, suction hose connection nozzle. 1 polythene bag.	185601R220	<b>1.068,10</b>
<b>Pull 2 M Set D</b>	REMS Pull 2 M Set including suction rotor for dust extraction. Ideal for extracting health hazardous dusts when dry drilling with REMS Picus S1, Picus SR, Picus S3 etc.	185604R220	<b>1.241,45</b>

Extraction of health hazardous dusts when chasing and cutting:  
REMS Pull 2 L Set



REMS Pull 2 L Set



Safety extractor of dust class L



REMS Pull 2 M Set



Safety extractor of dust class M

### Accessories

Description	Art.-No.	€
<b>Felt filter bag (pack of 5)</b> , polyester felt, 3-ply, tear-proof, for wet and dry extraction, M-certified, for normal dirt, fine dusts, abrasive dusts, wet dirt	185511R05	<b>56,26</b>
<b>Wet filter bag (pack of 5)</b> , paper-polyester woven felt, tear-proof, for wet and dry extraction, for abrasive dusts, wet dirt, liquids	185512R05	<b>93,94</b>
<b>Polythene bag (pack of 10)</b> , for wet and dry extraction of non-health hazardous dusts, for normal dirt, fine dusts, abrasive dusts, wet dirt, liquids. Prevents soiling of the tank.	185513R10	<b>52,83</b>
<b>Flat folded filter PES</b> , polyester, nano-coated, 1 piece, water-resistant, non-rotting, washable with water. For wet and dry extraction, M-certified	185515R01	<b>85,01</b>
<b>Suction rotor for dust extraction</b> see page 311	180160R	<b>173,35</b>
<b>Water suction device</b> see page 311	183606R	<b>393,40</b>
<b>Adapter suction hose/power tool</b> , for connecting a power tool to the extractor	185654R	<b>63,94</b>





  
PRESS

**Drying**  
**Dehumidifying**  
**Aeration and deaeration**



**Air dehumidifier/  
building dryer**

**328**



**Construction ventilators**

**330**

Powerful, highly efficient air dehumidifiers/building driers for drying rooms, e.g. after mains water damage, flooding, dehumidification of damp cellar rooms etc. and for fast drying of concrete, masonry, plaster and screed for example. For commercial use in trade and industry.

### REMS Secco 50

Dehumidification rate  $\leq 50 \text{ l}/24 \text{ h}$   
Air volume  $\leq 265 \text{ m}^3/\text{h}$

### REMS Secco 80

Dehumidification rate  $\leq 80 \text{ l}/24 \text{ h}$   
Air volume  $\leq 850 \text{ m}^3/\text{h}$

## REMS Secco – for drying and dehumidification.

### Universal use

Powerful, highly efficient air dehumidifiers/building driers for drying rooms, e.g. after mains water damage, flooding, dehumidification of damp cellar rooms etc. and for fast drying of concrete, masonry, plaster and screed for example. For commercial use in trade and industry.

### Design Secco 50

Compact, handy construction in robust, plastic housing. Weight 21 kg. Large air extraction areas with washable air filter. Electronic hygostat for regulating the desired humidity: Switches off automatically on reaching the nominal humidity, switches back on automatically when humidity rises. Upward air outlet for optimum air circulation. Condensation draining into an internal 7.7 l condensation tank, hose extendible from the rear, for draining condensation into a tank to be provided or directly into the drain system. Automatic switch-off with switch-off signal when using the internal 7.7 litre condensation tank on reaching the maximum condensation filling level. Operating hours counter and electricity meter, e.g. for reporting to the damage regulator/customer, as an accessory. Sturdy plastic housing with castors for easy transport.

### Design Secco 80

Compact, handy construction in robust, powder-coated sheet steel housing. Weight 51 kg. Large air extraction areas with washable air filter. Electronic hygostat for regulating the desired humidity: Switches off automatically on reaching the nominal humidity, switches back on automatically when humidity rises. Side air outlet for optimum air circulation. Hose for draining condensation into an internal 11.5 l condensation tank (accessory), extendible at the side, for draining condensation into a tank to be provided or directly into the drain system. On/Off switch for operation with and without internal 11.5 litre condensation tank. Automatic switch-off with switch-off signal when using the internal 11.5 litre condensation tank on reaching the maximum condensation filling level. Operating hours counter and electricity meter, e.g. for reporting to the damage regulator/customer. Device socket for detachable connecting cable. Practical compartment for the connecting cable during transport. Sturdy, mobile tubular steel frame with large castors for easy transport, also over steps. Easy glide down and pull-up of the machine over the back of the tubular steel frame, e.g. from and onto the loading platform of a vehicle.

### Chiller unit Secco 50

High dehumidification rate by high quality chiller unit with highly efficient rotation compressor and high-performance capacitor motor 230 V, 760 W with electronic thawing system, for continuous operation. Very quiet running, also suitable for living rooms. Dehumidification rate  $\leq 50 \text{ l}/24 \text{ h}$ , air volume  $\leq 265 \text{ m}^3/\text{h}$ . High quality coolant R-290.

### Chiller unit Secco 80

High dehumidification rate by high quality chiller unit with highly efficient rotation compressor and high-performance condensation motor 230 V, 680 W with automatic hot-gas thawing system, for continuous operation. Very quiet running, also suitable for living rooms. Dehumidification rate  $\leq 80 \text{ l}/24 \text{ h}$ , air volume  $\leq 850 \text{ m}^3/\text{h}$ . High quality coolant R-290.

### Electronic control unit Secco 50

Large, illuminated control panel with clear display of actual and nominal humidity, operating state of the chiller unit, thawing function. Keys for setting the desired humidity in 5 % steps between 30 % and 90 % as well as for setting the continuous operation. Keys for 2 fan speeds. Key for timer. Memory function saves the settings for automatic continuation of operation after a power failure.

### Electronic control unit Secco 80

Illuminated 3" display with LCD technology, 70 mm screen diagonal, with clear display of actual and nominal humidity, operating hours, operating state of the chiller unit, the thawing function, the compressor protection function and the operating position for internal 11.5 litre condensation tank. Keys for setting the desired humidity in 1 % steps between 30 % and 90 % as well as for setting the continuous operation. Memory function saves the settings for automatic continuation of operation after a power failure.

### Condensation tank with pump Secco 50 and Secco 80

Condensation tank with condensation pump for pumping the condensation out of the condensation tank into a higher tank or a wash basin, as an accessory.





## Exhaust air set Secco 80

Generously dimensioned exhaust air hose Ø200 mm, 10 m long, with metal fastening eyes for hanging up on site, with connecting flange, for distribution of the exhaust air in the room, for dehumidifying cavities, e.g. above intermediate ceilings and for additional blowing of wet surfaces (accessory).

## REMS Orkan

For supporting electric dehumidifiers/construction driers. For faster drying and dehumidification after floods and water mains damage, it is an advantage to improve the air exchange with electric construction ventilators REMS Orkan (page 330).

### Supply format

**REMS Secco 50 Set.** Electric air dehumidifier/building dryer for commercial use. For drying rooms, dehumidifying cellars etc. and drying concrete, masonry, plaster and screed. Chiller unit with rotation compressor and capacitor motor 230V, 50 Hz, 760W, with automatic thawing system, for continuous operation. Very quiet running. Dehumidification rate ≤ 50 l/24 h, air volume ≤ 265 m<sup>3</sup>/h. Electronic control unit with large, illuminated display and memory function. Electronic humidity switch. Air filter. Internal 7.7 l condensation tank. In sturdy plastic housing with casters. In a carton.

	Art.-No.	€
	132011R220	<b>777,46</b>

Other voltages on request.

### Supply format

**REMS Secco 80 Set.** Electric air dehumidifier/building dryer for commercial use. For drying rooms, dehumidifying cellars etc. and drying concrete, masonry, plaster and screed. Chiller unit with rotation compressor and capacitor motor 230V, 50 Hz, 680W, with automatic hot-gas thawing system, for continuous operation. Very quiet running. Dehumidification rate ≤ 80 l/24 h, air volume ≤ 850 m<sup>3</sup>/h. Electronic control unit with illuminated 3" display and memory function. Electronic hygrostat, operating hours counter, electricity meter. Air filter. In a sturdy sheet steel housing on a mobile tubular steel frame with large castors. In a carton.

	Art.-No.	€
	132010R220	<b>2.169,42</b>

Other voltages on request.

### Accessories

Description	Art.-No.	€
<b>11.5 litre condensation tank Secco 80</b> for discharge of condensation in the sheet steel housing. For REMS Secco 80.	132100R	<b>53,35</b>
<b>Exhaust air set Secco 80</b> , consisting of exhaust air hose Ø200 mm, 10 m long, with metal fastening eyes for hanging up on site, with connecting flange, for distribution of the exhaust air in the room, for dehumidifying cavities, e.g. above intermediate ceilings and for additional blowing of wet surfaces.	132104R	<b>318,67</b>
<b>Condensation tank with Secco 50 pump</b> for pumping the condensation out of the condensation tank into a higher tank or a wash basin. Pumping height ≤ 2 m. For REMS Secco 50.	132129R220	<b>389,25</b>
<b>Condensation tank with Secco 80 pump</b> for pumping the condensation out of the condensation tank into a higher tank or a wash basin. Pumping height ≤ 2 m. For REMS Secco 80.	132121R220	<b>389,25</b>
<b>Operating hours counter and electricity meter</b> , e.g. for reporting to the damage regulator/customer. For REMS Secco 50 and others.	132132R220	<b>54,81</b>
<b>REMS Detect W</b> , dielectric moisture measuring device for non-destructive moisture measurement in building materials, e.g. concrete, masonry, plaster, wood. In a case.	132115R	<b>233,55</b>
<b>REMS Orkan</b> , electric construction ventilator, see page 330.		

All prices excl. VAT



Info



Info



Powerful, highly efficient electric construction ventilator for supporting dehumidifiers/construction driers after floods and water mains damage. Ideal for aeration and deaeration of rooms, spaces, shafts and cavities as well as aeration and wind cooling of machines, marquees, event halls. For supporting the exchange of air in damp, musty cellar rooms and for speeding up the drying of concrete, masonry, plaster and screed, for example. For commercial use in trade and industry.

### REMS Orkan 1360

Air volume	1360 m <sup>3</sup> /h
Power	145 W

### REMS Orkan 2050

Air volume stage I	1740 m <sup>3</sup> /h
Power stage I	355 W
Air volume stage II	2050 m <sup>3</sup> /h
Power stage II	450 W

## REMS Orkan – for aeration.

### Universal use

Powerful, highly efficient construction ventilator for supporting dehumidifiers/construction driers after floods and water mains damage. Ideal for aeration and deaeration of rooms, spaces, shafts and cavities as well as aeration and wind cooling of machines, marquees, event halls. For supporting the exchange of air in damp, musty cellar rooms and for speeding up the drying of concrete, masonry, plaster and screed, for example. For commercial use in trade and industry.

### Design Orkan 1360

Axial fan in sturdy plastic housing of rotation-moulded polyethylene for a long life. Compact, handy design, weighing only 6.8 kg, with low-noise, single-phase capacitor motor 230 V, 145 W, with practical handle for carrying. Generated air volume 1,360 m<sup>3</sup>/h.

Large-diameter exhaust air and suction hose, Ø 200 mm, 10 m long, e.g. for extracting air from rooms, spaces, shafts and cavities, for discharging sucked-in air or dusts to the outside and for inflating bouncy castles, hot-air balloons, for example, as an accessory. An exhaust and suction hose can be fitted to the aeration or deaeration side of the construction ventilator as the situation requires. Dust sack, Ø 200 mm, 2,980 mm long, washable, for collecting coarse and fine dusts up to dust class M, as an accessory.

### Design Orkan 2050

Turbo radial fan with 2 air volume stages, in sturdy plastic housing of rotation-moulded polyethylene for a long life. Compact, handy design, weighing only 10 kg, with low-noise, single-phase capacitor motor 230 V, 355/450 W, with practical handle for carrying. Horizontal air outlet, adjustable to below 45° or vertical by appropriate resting surfaces on the plastic housing. Generated air volume in 2 selectable stages 1,740/2,050 m<sup>3</sup>/h. Especially suitable for speeding up drying of concrete, masonry, plaster and screed, for example.



### Supply format

**REMS Orkan 1360.** Electric construction ventilator for commercial use. For aeration and deaeration of rooms, spaces, shafts and cavities as well as aeration and wind cooling of machines, marquees, event halls. For supporting the exchange of air in damp, musty cellar rooms, for supporting the drying of, e.g., concrete, masonry, plaster and screed and for inflating bouncy castles, hot air balloons, for example. Capacitor motor 230V, 50 Hz, 145W, for continuous operation. Very quiet running. Air volume 1,360 m<sup>3</sup>/h. In a sturdy plastic housing. In a carton.

	Art.-No.	€
	132300R220	<b>410,01</b>

Other voltages on request.



Info

### Supply format

**REMS Orkan 2050.** Electric construction ventilator for commercial use. For aeration and deaeration of rooms, spaces, shafts and cavities as well as aeration and wind cooling of machines, marquees, event halls. For supporting the exchange of air in damp, musty cellar rooms. Especially also for drying of, e.g., concrete, masonry, plaster and screed. Capacitor motor 230V, 50 Hz, 355/450 W, for continuous operation. Very quiet running. Air volume 1,740/2,050 m<sup>3</sup>/h. In a sturdy plastic housing. In a carton.

	Art.-No.	€
	132301R220	<b>432,85</b>

Other voltages on request.



Info

### Accessories

Description	Art.-No.	€
<b>Exhaust air and suction hose, Ø 200 mm, 10 m long,</b> for extracting air from rooms, spaces, shafts and cavities, for discharging sucked-in air or dusts to the outside and for inflating bouncy castles, hot-air balloons, for example. For REMS Orkan 1360.	132307R	<b>158,71</b>
<b>Dust sack, Ø 200 mm, 2,980 mm long, washable,</b> for collecting coarse and fine dusts up to dust class M. For REMS Orkan 1360.	132308R	<b>146,67</b>
<b>Operating hours counter and electricity meter,</b> e.g. for reporting to the damage regulator/customer. For REMS Orkan and others.	132132R220	<b>54,81</b>
<b>REMS Detect W,</b> dielectric moisture measuring device for non-destructive moisture measurement in building materials, e.g. concrete, masonry, plaster, wood. In a case.	132115R	<b>233,55</b>
<b>REMS Secco,</b> electric air dehumidifiers/building driers, see page 328.		



# Index

## A

Aeration and deaeration.....	327
Akku-Press 22V ACC.....	192–193
Akku-Press 22V Connected.....	194–195
Akku-Press E 22V ACC.....	190–191
Akku-Press XL 45 kN 22V ACC.....	196–197
Amigo.....	25
Amigo 2.....	26
Amigo 2 Compact.....	27
Amigo 22V.....	28–29
Amigo E.....	24
Aquila 3B.....	105
Aquila WB.....	105
Assembling.....	103
Attachment heads for button dies / intermediate rings / guide bushings.....	31
Axial Press Jointing.....	243
Ax-Press 25 22V ACC.....	246–247
Ax-Press 25 L 22V ACC.....	246–247
Ax-Press 30 22V.....	244
Ax-Press HK / H.....	245

## B

Bending.....	127
Bending formers and back formers.....	143
Blitz.....	266
Brazing solder ISO 17672-CuP 179.....	267
Butt welding machine.....	294–297
Butt welding units.....	298

## C

Cable shear.....	241
Calc-Push.....	116
Calibrating.....	73
Calibrating tool and outer-inner pipe deburrer.....	100
Calibrating tools and inner pipe deburrers.....	101
Calibrating tools and outer-inner pipe deburrers.....	101
CamScope HD.....	275
CamSys.....	276–277
CamSys 2.....	278–280
Cat 22V VE.....	60–61
Catch S.....	104
Catch W.....	104
Cat VE.....	59
Cento.....	84–85
Cento 22V.....	86–87
Chain pipe vice.....	105
Chain pipe vice for workbench.....	105
Chamfering.....	73
Chasers.....	44
Chasers and Holders.....	44
Circular pipe sawing machine.....	70
CleanH.....	119, 123
Cleaning.....	113
Cleaning and preservation unit for heating systems.....	119, 123
Cleaning pads.....	264
CleanM.....	123
Cobra 22/32.....	286–289
Collum.....	49
Collum 22V.....	50–51
Compression heads.....	248–249
Confirmation of suitability.....	239
Contact 2000.....	265
Cordless axial press 13 kN with automatic return.....	246–247
Cordless axial press 20 kN with automatic return.....	246–247
Cordless axial press 30 kN.....	244
Cordless die stock with quick-change die heads.....	28–29
Cordless drain cleaning machine.....	284–285
Cordless LED flood light.....	111
Cordless pipe cutter.....	83
Cordless pipe cutting machine.....	86
Cordless pipe expander 20 kN with automatic return.....	254–255
Cordless pipe reciprocating saw.....	66–67
Cordless power drill/screwdriver.....	108–109
Cordless radial press 22 kN with automatic circuit control.....	147–151
Cordless radial press 32 kN with automatic circuit control.....	190–191
Cordless radial press 32 kN with automatic circuit control, pressure monitoring and result display.....	192–193
Cordless radial press 32 kN with Connected functionality via Wi-Fi radio standard and OLED display.....	194–195
Cordless radial press XL 45 kN with automatic circuit control.....	196–197
Cordless roll grooving machine.....	50–51
Cordless tube bender.....	132–133, 140–141
Cordless universal reciprocating saw.....	60–61
Cropping tongs.....	241
Cropping tongs Mini.....	184
Curvo.....	136–137
Curvo 22V.....	140–141
Curvo 50.....	138–139
Cut 110 Cu-INOX.....	95
Cut 110 P.....	94
Cutter wheels.....	81
Cutting.....	73
Cu-Vlies.....	264

## D

Deburring.....	73
Dehumidifying.....	327
Diamond chasing and cutting machine.....	301
Diamond chasing and cutting machines.....	322–323
Diamond core drilling.....	301
Dies.....	30, 40
Disinfecting.....	113
Disinfection unit for drinking water installations.....	119, 123
Drain cleaner for manual and electric operation.....	282
Drill stands.....	310
Dry and wet extractor.....	324–325
Dry diamond core drilling crowns LS.....	319
Drying.....	327
DueCento.....	88–89

## E

Eco-Press.....	185
Electric air dehumidifiers/building driers.....	328–329, 331
Electric construction ventilator.....	330–331
Electric decalcifying pump.....	116
Electric diamond core drilling machine.....	302–305, 308–309
Electric diamond core drilling machine with micro-pulse technology.....	316–317
Electric diamond core drilling machine with speed regulation.....	306–307
Electric die stock with quick-change die heads.....	24–27
Electric drain cleaning machine.....	283
Electric filling and flushing unit.....	124–125
Electric LED flood light.....	110
Electric pipe and drain cleaning machines.....	286–287
Electric pipe and tube bender.....	136–139
Electric pipe cutter.....	82
Electric pipe freezing unit.....	271
Electric pressure testing pump.....	115
Electric radial press 32 kN.....	186
Electric reciprocating pipe saws.....	62–63
Electric sleeve welding unit.....	292
Electric soldering pliers.....	264
Electric soldering unit.....	265
Electric tube expander.....	260–261
Electric tube extractor.....	259, 261
Electro-hydraulic pipe expander 34 kN with automatic return.....	256
Electro-hydraulic radial press 32 kN with automatic retraction.....	187
Electro-hydraulic radial press XL 32 kN with automatic retraction.....	188
Electronic camera inspection system.....	276–279
Electronic flushing and pressure testing unit with compressor.....	120–123
Electronic flushing unit with compressor.....	117–119
EMSG 160-2.....	292
Endoscope camera.....	274–275
E-Push 2.....	115
Eskimo.....	270
Eva.....	22
Expander heads P.....	257
Expander heads P-CEF.....	257
Expanding.....	251
Ex-Press 22V ACC.....	254–255
Ex-Press Cu.....	252
Ex-Press H.....	253
Ex-Press P.....	253
Extracting.....	251

## F

Filling.....	113
Flushing.....	113
Folding work bench.....	70–71
Folding work benches.....	106
Freezing.....	269
Frigo 2 F-Zero.....	271

## H

Hand die stock with quick-change die heads.....	22
Hand pressure testing pump.....	114
Hand tube bender.....	142
Hand tube expander.....	252–253
Hand tube extractor.....	258
Helix 22V VE.....	108–109
Herkules.....	107
Hold-Harmless and Indemnification Agreement.....	240
Hot Dog 2.....	264
Hurrican.....	259
Hurrican H.....	258
Hydro-Swing.....	130–131
Hydro-Swing 22V.....	132–133

## I

Inner pipe deburrer.....	97
--------------------------	----

## J

Jumbo.....	106
------------	-----

# Index

## K

KaliGrat E	100
KaliGrat H	101
KaliGrat R	101
Krokodil 180 SR	322–323

## L

Lot Cu 3	267
Lot P6	267
Lumen 2800 22V	111
Lumen 5000/7000/10000	110

## M

Machine cleaner	123
Macho	266
Magnum RG	52–53
Magnum (up to 2")	34–35
Magnum (up to 3")	36–37
Magnum (up to 4")	38–39
Manual axial press	245
Manual radial press	185
Material supports	107
Mini-Cobra	282
Mini-Cobra S	283
Mini-Cobra S 22V VE	284–285
Mini-Press 14V ACC	147
Mini-Press 22V ACC	148–149
Mini-Press S 22V ACC	150–151
MiniScope	274
MSG	293
Multi-Push S	117–119
Multi-Push SL/SLW	120–123

## N

Nano	82
Nano 11 V	83
Nippelfix	46
Nippelspanner	46
NoCor	119, 123

## O

Oil-hydraulic hand pipe bender	130–131
Oil-hydraulic pipe bender	134–135
One-hand axial press	245
One-hand pipe expander	253
One-hand pipe shears	90–92
One-hand pipe shears with ratchet feed	93
Orkan 1360/2050	330–331
Outer-inner pipe deburrer	98–99
Outer-inner tube deburrer	97

## P

Paste Cu 3	267
Peroxi Color	119, 123
Picus DP	316–317
Picus S1	302–303
Picus S2/3,5	308–309
Picus S3	304–305
Picus SR	306–307
Pipe and Drain cleaning	273
Pipe and Drain inspection	273
Pipe chamfering tools	96
Pipe cutter	80
Pipe cutters	74–79
Pipe cutting and pipe chamfering tool	94
Pipe cutting machine	84–85, 88
Pipe cutting tool	95
Pipe freezer	270
Pipe shears with ratchet feed	93
Pipe splitter	80
Plastic Pipe Welding	291
Pneumatic reciprocating pipe saw	64
Portable pipe workstation with chain pipe vice	105
Power-Ex-Press P-CEF ACC	256
Power-Press ACC	187–188
Power-Press SE	186
Preserving	113
Pressing rings	152–183, 198–237
Pressing tongs	198–237
Pressing tongs Mini	152–183
Pressure testing	113
Pull 2 L / M	324–325
Pull-Push	282
Puma VE	58
Push	114
Python	134–135

## Q

Quick-change die heads	30
Quick-change die heads S	23

## R

Radial Press Jointing	145
RAG	96
RAS Cu	77–78
RAS Cu-INOX	75–76
RAS P	78–79
RAS P/SW 45/L	80
RAS St	74
RAS W INOX	80
Reciprocating saws	56–57
REG 3–35	97
REG 8–35	98
REG 10–42	98
REG 10–54	99
REG 10–54 E	99
REG St 1/4–2"	97
REG Universal	97
Roll Grooving	21
Roll grooving attachment	48
Roll grooving machine	49, 52–53
ROS P	92–93
ROS P 26/SW 35 S	91
ROS PEX	92
ROS P flex	90

## S

Sanitol	47
Saw blades	69
Sawing	55
Secco 50/80	328–329
Single-hand tube bender	128–129
Sinus	142
Sleeve welding units	293
Soft solder paste of solder powder Sn97Cu3 according to ISO 9453:2014 and flux 3.1.1.C, EN 29454-1:1994	267
Soft solder Sn97Cu3, ISO 9453:2014	267
Solar-Push	124–125
Soldering	263
Special saw blades	68
Spezial	47
SSG	298
SSM 160KS	295
SSM 160RS	294
SSM 250KS	296
SSM 315RF	297
Suction and pressure cleaning device	282
Swedish pattern wrench 'S'	104
Swing	128–129

## T

Thread-cutting oil	47
Threading	21
Threading machine	32–39, 42–43
Thread tables	45
Tiger 22V VE	66–67
Tiger pneumatic	64
Tiger/VE/SR	62–63
Tile drilling	320
Tornado	32–33
Turbo Cu-INOX	70
Turbo K	71
Turbo soldering torch acetylene	266
Turbo soldering torch propane	266
Twist	260
Twist/Hurricane	261

## U

Unimat 75	42–43
Universal circular metal sawing machine with automatic cooling lubricant unit	71
Universal deburrer	97
Universal diamond core drilling crowns	312–313
Universal diamond core drilling crowns LS	314–315
Universal electric reciprocating saw	58–59
Universal saw blades	68

## V

V-Jet H	119, 123
V-Jet TW	119, 123

## W

Water pump pliers	104
Wet and dry suction	301

# List of articles

Art.-No.	RG	VE	Page	Art.-No.	RG	VE	Page	Art.-No.	RG	VE	Page	Art.-No.	RG	VE	Page
043054	Z		119, 122, 125	114060	Z		101	140106	V	15	47	150958	Z		257
045159	Z		119, 122	114061	Z		101	140110	V	4	47	150960	Z		257
047069	Z		122	115000	H		114	140113	V		47	150961	Z		257
074021	Z		258	115001	H		114	140115	V	12	47	150962	Z		257
074041	Z		258	115045	Z		114–115, 122	140116	V	15	47	150963	Z		257
076117	Z		258	115110	Z		114–115	140119	V	15	123	150968	Z		257
079003	Z		311, 313, 315, 318–319	115140	Z		122	140120	V	15	137, 139, 141–142	151000	E		259
079005	Z		311, 318	115217	Z		125	150000	H		252	151002	E		259
079006	Z		311, 318	115220	Z		125	150005	H		252	151003	H		258
079010	Z		311, 318	115221	Z		125	150006	H		252	151004	H		258
079012	Z		311, 313, 315, 318–319	115311	M		125	150007	H		252	151005	H		258
079013	Z		311, 318	115312	M		125	150008	H		252	151010	E		259
079018	Z		311, 318	115314	Z		125	150010	H		252	151105	Z		258–259, 261
079019	Z		311, 318	115315	Z		125	150017	H		252	151110	Z		258–259, 261
090015	Z		119, 123	115319	Z		125	150018	H		252	151120	Z		258–259, 261
091072	Z		119, 123	115323	Z		125	150019	H		252	151125	Z		258–259, 261
091073	Z		119, 123	115324	Z		125	150020	H		252	151130	Z		258–259, 261
110000	Z		46	115325	Z		125	150021	H		253	151140	Z		258–259, 261
110100	Z		46	115326	Z		125	150022	H		253	151145	Z		258–259, 261
110200	Z		46	115375	Z		125	150025	H		253	151150	Z		258–259, 261
110300	Z		46	115500	M		115	150026	H		253	151155	Z		258–259, 261
110400	Z		46	115602	Z		119, 123	150027	H		253	151160	Z		258–259, 261
110500	Z		46	115604	Z		119, 123	150028	H		253	151165	Z		258–259, 261
110600	Z		46	115605	Z	6	119, 123	150029	H		253	151170	Z		258–259, 261
110620	Z		46	115607	Z	6	119, 123	150033	H		253	151175	Z		258–259, 261
110621	Z		46	115608	Z	6	119, 123	150100	Z		252	151200	Z		258–259, 261
111000	Z		46	115609	Z		119, 122	150105	Z		252	151210	Z		258–259, 261
111100	Z		46	115610	M		122	150110	Z		252	151230	Z		258–259, 261
111200	Z		46	115611	M		122	150120	Z		252	151240	Z		258–261
111300	Z		46	115612	Z		119, 123	150125	Z		252	151402	Z		258–261
111400	Z		46	115621	Z		119, 122	150130	Z		252	151600	Z		259–261
111500	Z		46	115633	Z		119, 122	150140	Z		252	151618	Z		258
111620	Z		46	115661	Z		122	150145	Z		252	152106	Z		266
111621	Z		46	115667	Z		122	150150	Z		252	152109	Z		266
111700	Z		46	115677	Z		119, 123	150155	Z		252	153020	H		129
111800	Z		46	115703	Z		119, 123	150160	Z		252	153021	H		129
111900	Z		46	115747	Z		122	150165	Z		252	153022	H		129
113000	H		74	115810	M		118	150170	Z		252	153023	H		129
113100	H		74	115900	M		116	150175	Z		252	153025	H		129
113200	H	10	75	116000	H		104	150180	Z		252	153026	H		129
113210	V	10	76, 81, 94–95	116005	H		104	150185	Z		252	153027	H		129
113213	V	10	76, 81	116010	H		104	150190	Z		252	153028	H		129
113220	V	10	81	116015	H		104	150195	Z		252	153029	H		129
113225	V	10	78, 81	116020	H		104	150205	Z		252	153030	H		128
113230	H	10	75	116050	H		104	150210	Z		252	153100	Z		129
113240	H	10	75	116055	H		104	150220	Z		252	153115	Z		129, 131, 133
113241	H	10	75	116060	H		104	150225	Z		252	153125	Z		129
113250	H	10	77	120120	Z		107	150230	Z		252	153140	Z		129
113255	H	10	77	120125	Z		107	150235	Z		252	153155	Z		129, 131, 133
113260	H	10	77	120130	Z		107	150240	Z		252	153160	Z		129, 131, 133
113300	H	10	76	120200	Z		106	150245	Z		252	153170	Z		129, 131, 133
113320	H	8	77	120240	Z		106	150250	Z		252	153175	Z		129, 131, 133
113330	H	8	75	120250	Z		105	150500	Z		252	153180	Z		129, 131, 133
113340	H	10	77	120270	Z		105	150510	Z		253	153185	Z		129, 131, 133
113350	H	10	75	130002	H		270	150515	Z		255, 257	153190	Z		129, 131, 133
113351	H	10	75	130207	Z		270	150550	H		253	153195	Z		129, 131, 133
113360	Z	10	76, 78, 97	130208	Z		270	150600	Z		252–253	153200	Z		129, 131, 133
113370	H		78	130209	Z		270	150806	Z		257	153205	Z		129, 131, 133
113380	H		76	130383	Z		270	150807	Z		257	153210	Z		129, 131, 133
113385	H		76	130410	Z		270	150808	Z		257	153265	Z		128–129
113400	H		76	130415	Z		270	150809	Z		257	153270	Z		129
113401	H		76	130430	Z		270	150812	Z		257	153300	Z		128
113410	H		78	130450	Z		270	150826	Z		257	153303	Z		128
113450	H		80	130455	Z		270	150828	Z		257	153304	Z		128
113461	V	10	80–81	130460	Z		270	150842	Z		257	153305	Z		128
113480	H	10	80	130465	Z		270	150843	Z		257	153306	Z		128
113481	Z		80	130470	Z		270	150845	Z		257	153307	Z		128
113500	H		76	130475	Z		270	150846	Z		257	153400	Z		133
113810	H		98	130480	Z		270	150849	Z		257	153401	E		133
113815	Z		98	130485	Z		270	150855	Z		257	153410	E		133
113825	H	10	98	130490	Z		270	150858	Z		257	153411	E		133
113830	H	10	99	130495	Z		270	150868	Z		257	153412	E		133
113835	H	10	99	131012	M		271	150873	Z		257	153413	E		133
113840	Z		85, 87	131104	Z		271	150882	Z		257	153414	E		133
113900	H	10	97	131110	Z		271	150883	Z		257	153415	E		133
113910	H	10	97	131116	Z		271	150885	Z		257	153416	E		133
114000	H		100	131156	Z		271	150886	Z		257	153417	E		133
114001	H		100	131157	Z		271	150887	Z		257	153418	E		133
114030	Z		100	131158	Z		271	150888	Z		257	153419	E		132
114032	Z		100	131160	Z		271	150894	Z		257	153450	Z		131, 133
114033	Z		100	132010	M		329	150897	Z		257	153455	Z		133
114034	Z		100	132011	M		329	150912	Z		257	153500	Z		131
114035	Z		100	132100	Z		329	150913	Z		257	153501	Z		131, 133
114036	Z		100	132104	Z		329	150914	Z		257	153510	H		131
114037	Z		100	132115	Z		329, 331	150915	Z		257	153520	H		131
114038	Z		100	132121	Z		329	150916	Z		257	153521	H		131
114039	Z		100	132129	Z		329	150923	Z		257	153522	H		131
114040	Z		100	132132	Z		329, 331	150926	Z		257	153523	H		131
114041	Z		100	132300	M		331	150943	Z		257	153525	H		131
114042	Z		100	132301	M		331	150944	Z		257	153526	H		131
114043	Z		100	132307	Z		331	150945	Z		257	153527	H		131
114044	Z		100	132308	Z		331	150946	Z		257	153528	H		131
114045	Z		101	140100	V	4	47	150947	Z		257	153529	H		131
114046	Z		101	140101	V		47	150950	Z		257	153531	Z		131, 133
114047	Z		101	140103	V		47	150952	Z		257	153532	Z		131, 133
114048	Z		101	140105	V	12	47	150957	Z		257	153540	Z		131, 133

# List of articles

Art.-No.	RG	VE	Page	Art.-No.	RG	VE	Page	Art.-No.	RG	VE	Page	Art.-No.	RG	VE	Page
153570	Z		131	172611	Z		289	181050	V		313	250320	E		298
154000	Z		142	172612	Z		289	181055	V		313	250341	Z		298
154001	H		142	174000	Z		287	181059	V		313	250342	Z		298
154002	H		142	174010	M		287	181060	V		313	250343	Z		298
154003	H		142	174011	M		287	181065	V		313	252026	M		294
154004	H		142	174012	M		287	181070	V		313	252046	M		295
154010	H		142	174050	Z		288	181075	V		313	252103	Z		294-295
154160	Z		142	174101	Z		288	181080	V		313	254025	M		296
156000	E		260	174150	Z		288	181085	V		313	254103	Z		296
156002	E		260	174154	Z		288	181090	V		313	255020	M		297
156004	E		260	174200	Z		288	181095	V		313	255103	Z		297
156010	E		261	174201	Z		288	181410	V		315	256020	E		293
156012	E		261	174203	Z		288	181415	V		315	256213	E		293
156014	E		261	174205	Z		288	181420	V		315	256220	E		293
156150	Z		260-261	174210	Z		288	181425	V		315	256233	E		293
156200	Z		260-261	174250	Z		289	181430	V		315	256240	E		293
156225	Z		260-261	174265	Z		289	181435	V		315	256242	Z		293
156250	Z		260-261	174270	Z		289	181440	V		315	256320	E		293
156300	Z		260-261	174275	Z		289	181445	V		315	256342	Z		293
156350	Z		260-261	174282	Z		289	181450	V		315	256400	Z		293
156375	Z		260-261	174291	Z		289	181455	V		315	256410	Z		293
156400	Z		260-261	174293	Z		289	181459	V		315	256420	Z		293
156425	Z		260-261	174295	Z		289	181460	V		315	256430	Z		293
156450	Z		260-261	174296	Z		289	181465	V		315	256440	Z		293
156475	Z		260-261	174305	Z		289	181470	V		315	256450	Z		293
160010	H		266	174306	Z		289	181475	V		315	256460	Z		293
160200	V	10	267	174310	Z		289	181480	V		315	256470	Z		293
160210	V	10	267	174311	Z		289	181500	V		319	256480	Z		293
160220	V	10	267	174340	Z		289	181502	V		319	256490	Z		293
160300	V	25	264	174341	Z		289	181504	V		319	256500	Z		293
161010	H		266	175000	Z		277	181506	V		319	256510	Z		293
163020	E		264	175007	M		277	181508	V		319	256520	Z		293
163350	Z		264	175008	M		277	181510	V		319	256530	Z		293
164011	E		265	175010	M		277	181512	V		319	261002	E		292
164050	E		265	175011	Z		277	181514	V		319	290000	H		79
164110	Z		265	175018	Z		277	181516	V		319	290001	H	10	78
164111	Z		265	175026	Z		277, 280	181518	V		319	290002	H	10	78
164115	Z		265	175057	Z		277, 280	181520	V		319	290016	V	10	79, 81
164250	Z		265	175058	Z		277, 280	181522	V		319	290023	V	10	79, 81
170010	H		282	175123	Z		277, 280	181524	V		319	290050	H		79
170011	Z		288	175210	Z		111	181526	V		319	290100	H		79
170012	Z		288	175211	Z		111	181528	V		319	290116	V	10	79, 81
170022	E		283	175220	Z		110	181530	V		319	290200	H		79
170023	E		283	175221	Z		110	181532	V		319	290216	V	10	79, 81
170025	E		285	175222	Z		110	181700	V		320	290300	H		79
170027	E		285	175230	Z		110-111	181710	V		320	290316	V	5	79, 81
170118	Z		282, 285	175300	Z		280	181711	V		320	290400	H		94
170200	Z		282, 288	175301	M		279	181712	V		320	290410	H		95
170201	Z		282-283, 285	175302	M		279	181713	V		320	290411	H		95
170205	Z		282-283, 285	175303	M		279	181714	V		320	290412	H		95
170300	H		282	175304	M		279	181715	V		320	290420	Z		94
171150	Z		288	175305	Z		277, 280	182006	Z		311	290421	Z		94
171151	Z		288	175306	Z		277, 280	182010	Z		311, 318	290422	Z		94
171200	Z		288	175307	Z		280	182050	Z		311, 318	290423	Z		94
171201	Z		288	175308	Z		280	183000	Z		307	290424	Z		94
171205	Z		288	175312	Z		280	183010	E		307	290425	Z		94
171210	Z		288	175323	Z		280	183022	E		307	290426	Z		94
171250	Z		289	175330	Z		280	183023	E		307	290427	Z		94
171265	Z		289	175339	Z		280	183600	Z		310, 318	290430	Z		94
171270	Z		289	175343	Z		280	183603	Z		311, 318	290431	Z		94
171275	Z		289	175400	E		275	183604	Z		311, 318	290432	Z		94
171280	Z		289	175401	E	6	274	183605	Z		311, 318	290433	Z		94-95
171290	Z		289	175440	Z		275	183606	Z		311, 325	290437	Z		94
171291	Z		289	180000	Z		303	183607	Z		311, 318	290440	Z		94-95
171305	Z		289	180001	Z		305	183632	Z		307, 310	290444	Z		94
171306	Z		289	180003	Z		317	183670	Z		311, 318	290445	Z		94
171340	Z		289	180010	E		303	183675	Z		311	290446	Z		94
171341	Z		289	180011	E		305	183700	Z		310, 318	290447	Z		94
172000	Z		287	180012	E		309	185001	Z		323	290448	Z		94
172010	M		287	180015	Z		311, 313, 315, 318-319	185011	E		323	290449	Z		94
172011	M		287	180016	E		317	185024	Z		323	290500	H		79
172012	M		287	180028	E		305	185026	V		323	291000	H		93
172050	Z		288	180029	E		305	185027	V		323	291010	H		93
172051	Z		288	180030	E		309	185058	Z		283, 323	291023	Z		93
172150	Z		288	180032	E		303	185511	Z		325	291036	Z		93
172151	Z		288	180033	E		317	185512	Z		325	291037	Z		93
172154	Z		288	180035	E		317	185513	Z		325	291101	H		93
172200	Z		288	180036	E		317	185515	Z		325	291112	Z		93
172201	Z		288	180052	Z		313, 315	185600	M		325	291200	H		93
172203	Z		288	180053	Z		313, 315	185601	M		325	291201	Z		93
172205	Z		288	180054	Z		313, 315	185603	M		325	291220	H		93
172210	Z		288	180056	Z		313, 315	185604	M		325	291221	Z		93
172250	Z		289	180057	Z		313, 315	185654	Z		325	291240	H	8	92
172265	Z		289	180140	Z		311	190051	Z		109	291241	Z		92
172270	Z		289	180145	Z		318	190053	Z		109	291242	H	8	91
172275	Z		289	180155	Z		311, 313, 315, 318-319	190100	Z		109	291243	Z		91
172280	Z		289	180160	Z		311, 325	190110	E		109	291244	Z		91
172281	Z		289	180600	Z		303, 305, 307, 317	250020	E		298	291250	H		93
172290	Z		289	181010	V		313	250041	Z		298	291251	Z		93
172291	Z		289	181015	V		313	250042	Z		298	291270	H		93
172293	Z		289	181020	V		313	250120	E		298	291271	Z		93
172305	Z		289	181025	V		313	250142	Z		298	291290	H		93
172310	Z		289	181030	V		313	250143	Z		298	291400	H	10	90
172340	Z		289	181035	V		313	250220	E		298	291401	Z		90
172341	Z		289	181040	V		313	250242	Z		298	291410	H	10	90
172610	Z		289	181045	V		313	250243	Z		298	291411	Z		90

# List of articles

Art.-No.	RG	VE	Page	Art.-No.	RG	VE	Page	Art.-No.	RG	VE	Page	Art.-No.	RG	VE	Page
291420	H	8	92	342080	S		35, 37, 39	521120	Z		30	561002	V		68
291421	Z		92	344100	Z		33, 35, 37, 39, 53	521122	S		30	561003	V		68
291430	H	8	90	344105	Z		33, 35, 37, 39, 53	521130	Z		30	561004	V		68
291431	Z		90	344150	Z		33, 35, 37, 39, 53	521132	S		30	561005	V		68
292011	Z		96	347000	M		33, 35, 37, 39, 48	521140	Z		30	561006	V		68
292110	H		96	347001	M		48	521142	S		30	561007	V		68
292210	H		96	347005	M		51	521150	Z		30	561008	V		68
340100	Z		37, 39	347006	M		49	521152	S		30	561101	V		69
340110	Z		53	347007	Z		48	521160	Z		30	561102	V		69
340200	M		33	347008	M		49	521162	S		30	561103	V		69
340201	M		33	347009	M		49	521170	Z		30	561104	V		69
340202	M		33	347010	Z		49	521172	S		30	561105	V		69
340206	M		33	347030	Z		48	521180	Z		30	561106	V		69
340207	M		33	347034	Z		48	521182	S		30	561107	V		69
340208	M		33	347035	Z		48	521200	Z		30	561108	V		69
340220	M		35	347040	Z		48	521202	S		30	561109	V		69
340221	M		35	347046	Z		48	521210	Z		30	561110	V		69
340222	M		35	347047	Z		48	521212	S		30	561111	V		69
340226	M		35	347053	Z		48	521220	Z		30	561112	V		69
340227	M		35	380303	M		37	521222	S		30	561113	V		69
340228	M		35	380304	M		37	521230	Z		30	561114	V		69
340230	M		53	380305	M		37	521232	S		30	561115	V		69
340231	M		53	380306	M		37	521240	Z		30	561116	V		69
340232	M		53	380307	M		37	521242	S		30	561117	V		69
341000	Z		33, 35, 37, 39	380308	M		37	521250	Z		30	561118	V		69
341401	S		40	380309	M		37	521252	S		30	561119	V		69
341402	S		40	380310	M		37	521260	Z		30	561120	V		69
341403	S		40	380311	M		37	521262	S		30	561121	V		69
341404	S		40	380312	M		37	521270	Z		30	561122	V		69
341406	S		40	380313	M		37	521272	S		30	561123	V		69
341407	S		40	380314	M		37	521280	Z		30	561124	V		69
341408	S		40	380426	M		39	521282	S		30	561125	V		69
341409	S		40	380427	M		39	521300	Z		30	561126	V		69
341411	S		40	380428	M		39	521302	S		30	563000	Z		63-64, 67
341412	S		40	380429	M		39	521310	Z		30	563008	Z		63-64
341413	S		40	380430	M		39	521312	S		30	563100	Z		63-64
341414	S		40	380431	M		39	521320	Z		30	563200	Z		63-64
341416	S		40	380441	M		39	521322	S		30	563203	Z		63-64
341417	S		40	380442	M		39	521330	Z		30	565051	Z		71
341418	S		40	380443	M		39	521332	S		30	566030	Z		29, 61, 67, 141
341419	S		40	380444	M		39	521340	Z		30	566051	Z		58-59, 63-64
341426	S		40	380445	M		39	521342	S		30	570100	Z		200-201, 207-209, 212-213, 217, 220, 229-231, 234
341427	S		40	380446	M		39	521350	Z		30	570107	Z		200-201, 207-208, 210, 212, 221, 229-231, 235-236
341428	S		40	380447	M		39	521352	S		30	570110	Z		200-204, 206-221, 224-232, 234, 237
341429	S		40	380448	M		39	522000	Z		22-27, 29	570112	Z		200, 207-208, 210, 230
341430	S		40	381000	Z		37, 39	522051	Z		23	570115	Z		200-201, 206-208, 210-212, 214-215, 219, 221-224, 228-231, 235-237
341431	S		40	381050	Z		37	526050	Z		22	570117	Z		200, 207-208, 210, 230
341432	S		40	381401	S		40	526052	Z		23	570120	Z		200-204, 206-221, 224-232, 234, 237
341433	S		40	381405	S		40	530000	Z		25	570125	Z		200-201, 206-208, 210-212, 214-215, 219, 221-224, 228-231, 235-237
341434	S		40	381410	S		40	530003	Z		24	570130	Z		200-204, 206-221, 224-232, 234, 237
341435	S		40	381415	S		40	530004	Z		29, 51	570132	Z		200, 230, 235
341436	S		40	381430	S		40	530013	E		24	570135	Z		200-201, 206-208, 210-212, 214-215, 219, 221-224, 228-231, 235-237
341437	S		40	381431	S		40	530014	E		24	570137	Z		200, 230, 235
341438	S		40	381432	S		40	530015	E		29	570140	Z		200-204, 206-221, 224-232, 234, 237
341439	S		40	381433	S		40	530016	E		29	570145	Z		200-201, 207-208, 210-212, 214-215, 219, 221-224, 228-231, 235-237
341440	S		40	381622	V		5, 37, 39, 74, 81	530020	E		25	570150	Z		200-204, 206-221, 224-232, 234, 237
341441	S		40	520003	H		22	530022	E		25	570155	Z		200-201, 207-208, 210-212, 214-215, 219, 221-224, 228-231, 235-237
341442	S		40	520004	H		22	530023	E		25	570160	Z		200, 203, 206, 209, 213, 215-216, 220, 231, 234, 237
341443	S		40	520008	H		22	533000	Z		24-25	570165	Z		200-201, 207-208, 210-212, 214, 219, 221-224, 228-231, 235-237
341444	S		40	520009	H		22	536000	Z		24-25	570170	Z		200, 203, 206, 209, 213, 215-216, 220, 231, 234, 237
341445	S		40	520010	H		22	540000	Z		26	570175	Z		200-201, 207-208, 210-212, 214, 219, 221-224, 228-231, 235-237
341446	S		40	520013	H		22	540001	Z		27	570280	Z		186-187
341466	S		40	520014	H		22	540020	E		26	570290	Z		238
341467	S		40	520015	H		22	540022	E		26	570295	Z		238, 241
341468	S		40	520016	H		22	540023	E		27	570300	Z		201, 204-205, 213, 233
341469	S		40	520017	H		22	540024	E		27	570310	Z		204-206, 210, 216, 219, 222, 226-227, 232, 234
341470	S		40	520025	Z		23	540025	E		27				
341471	S		40	520026	Z		23	541401	Z		31				
341472	S		40	520056	Z		23	541404	Z		31				
341473	S		40	521000	Z		30	541406	Z		31				
341474	S		40	521002	S		30	541410	Z		31				
341475	S		40	521010	Z		30	541413	Z		31				
341476	S		40	521012	S		30	541414	Z		31				
341477	S		40	521020	Z		30	541415	Z		31				
341478	S		40	521022	S		30	541416	Z		31				
341479	S		40	521026	Z		23	543000	Z		26				
341480	S		40	521030	Z		30	543010	Z		27, 29				
341481	S		40	521032	S		30	543100	Z		24-26, 63-64				
341482	S		40	521036	Z		23	546000	Z		26-27				
341483	S		40	521040	Z		30	560000	Z		63				
341484	S		40	521042	S		30	560001	Z		63				
341485	S		40	521046	Z		23	560002	Z		64				
341486	S		40	521050	Z		30	560003	Z		58				
341487	S		40	521052	S		30	560004	Z		59				
341488	S		40	521056	Z		23	560008	Z		63				
341489	S		40	521060	Z		30	560010	E		61				
341490	S		40	521062	S		30	560011	Z		67				
341491	S		40	521066	Z		23	560020	E		63				
341493	S		40	521070	Z		30	560022	E		64				
341494	S		40	521072	S		30	560023	E		58				
341495	S		40	521080	Z		30	560026	E		63				
341496	S		40	521082	S		30	560027	E		63				
341497	S		40	521100	Z		30	560040	E		59				
341498	S		40	521102	S		30	560052	E		61				
341499	S		40	521110	Z		30	560053	E		67				
341614	V	10	33, 35, 37, 39, 74, 81	521112	S		30	561001	V		68				



# List of articles

Art.-No.	RG	VE	Page	Art.-No.	RG	VE	Page	Art.-No.	RG	VE	Page	Art.-No.	RG	VE	Page
570315	Z		222	570780	Z		200-201, 203-204, 206-207, 209-216, 218-227, 232-234, 236-237	571583	Z		29, 51, 61, 67, 87, 109, 111, 133, 141, 149, 151, 191, 193, 195, 197, 244, 247, 255, 285	572676	Z		227
570320	Z		201-206, 208-212, 214-219, 222-223, 226-228, 232-234, 236-237	570785	Z		200-228, 232-234, 236-237	571585	Z		29, 51, 61, 67, 87, 109, 111, 133, 141, 149, 151, 191, 193, 195, 197, 244, 247, 255, 285	572678	Z		227
570330	Z		219	570790	Z		200, 202, 204-205, 207, 209-211, 214-224, 226-228, 231-234, 236	571587	Z		29, 51, 61, 67, 87, 109, 111, 133, 141, 149, 151, 191, 193, 195, 197, 244, 247, 255, 285	572680	Z		227
570340	Z		201-202, 204-206, 209-210, 214, 216, 218-219, 222-223, 226-227, 232-233	570795	Z		204-205, 207, 209-211, 214-224, 226-228, 231-234, 236	571630	Z		234	572687	Z		210-211, 221, 225, 236
570350	Z		201-206, 208-212, 214-219, 222-223, 226-228, 232-234, 236-237	570845	Z		204, 206, 218, 226-227	571635	Z		201, 235-236	572689	Z		210-211, 221, 225, 236
570360	Z		201-202, 204-206, 209, 214-216, 218-219, 222-223, 232-233, 236	570850	Z		202, 204-206, 209, 211, 214, 217-219, 223, 226-228, 234, 236	571640	Z		201, 235-236	572691	Z		210-211, 221, 225, 236
570370	Z		202-212, 214, 216-219, 222-223, 226-228, 232-234, 237	570855	Z		204, 206, 209, 214, 218, 223, 226-227	571645	Z		235-236	572693	Z		211, 221, 225, 236
570380	Z		201-206, 208-212, 214-219, 222-223, 226-228, 232-234, 236-237	570860	Z		202, 204-206, 209, 211, 214, 217-219, 223, 226-228, 234, 236	571700	Z		206	572695	Z		211, 221, 225, 236
570390	Z		202, 205, 208-210, 214-218, 222-223, 228, 233-234, 236	570870	Z		202, 204-206, 209, 211, 214, 217-219, 223, 226-228, 234	571702	Z		206	572697	Z		211, 221, 225, 236
570400	Z		214	570880	Z		202, 204-206, 209, 211, 214, 217-219, 223, 227-228, 234, 236	571704	Z		206	572706	Z		200-204, 206-213, 215-221, 224-232, 234, 237
570410	Z		214	570905	Z		234	571710	Z		206	572708	Z		200-204, 206-213, 215-221, 224-232, 234, 237
570420	Z		214	570910	Z		206, 212, 226, 234, 236-237	571712	Z		206	572714	Z		227
570430	Z		214	570915	Z		206, 212, 226, 234, 236-237	571714	Z		206	572716	Z		227
570440	Z		214	570920	Z		226, 234, 236	571715	Z		223, 236	572727	Z		206, 213, 231
570450	Z		214	570925	Z		206, 212, 236-237	571717	Z		223, 236	572795	Z		238
570452	Z		213, 216, 218, 237	570930	Z		229-231	571718	Z		223, 236	572801	Z		238
570455	Z		200, 205-206, 209-210, 213, 215-216, 218, 220, 222, 225-228, 231-233, 236-237	570932	Z		230	571719	Z		223, 236	572802	Z		238
570457	Z		209, 213, 218, 225	570935	Z		214, 228-231	571720	Z		223, 236	572809	Z		238
570460	Z		200-206, 208-228, 231-234, 236-237	570937	Z		230	571722	Z		206	572810	Z		238
570462	Z		209-210, 213, 216, 218, 220, 225-226, 231, 237	570940	Z		214, 228-231	571724	Z		206	572813	Z		238
570465	Z		202, 204-206, 209-210, 213-216, 218, 220, 222-228, 231-233, 237	570945	Z		214, 228-231	571725	Z		223, 236	572815	Z		207, 223-224, 235-236
570467	Z		213, 215-216, 218, 225	570950	Z		214, 228-231	571726	Z		223, 236	572816	Z		207, 223-224, 235-236
570470	Z		200-206, 208-228, 231-234, 236-237	570955	Z		214, 228-231	571727	Z		223, 236	572817	Z		209, 214, 220-222, 235-236
570472	Z		218, 225	570970	Z		236	571728	Z		223, 236	572818	Z		209, 214, 220-222, 235-236
570475	Z		201-220, 222-228, 231-234, 236-237	571136	Z		238	571760	Z		223, 236	572819	Z		209, 214, 220-222, 235-236
570477	Z		218, 225	571137	Z		238	571764	Z		223, 228, 234-235	572820	Z		209, 214, 220-222, 235-236
570480	Z		200-206, 208-228, 231-234, 236-237	571283	Z		187	571766	Z		223, 228, 234-235	572821	Z		209, 214, 220-222, 235-236
570482	Z		205, 218, 234	571283	Z		187	571767	Z		223, 228, 234-235	572822	Z		236
570485	Z		200, 202-206, 209-210, 213-228, 232-234, 236-237	571290	Z		191, 193, 195	571770	Z		205, 209, 214, 220-223, 235-236	572823	Z		236
570487	Z		203, 205-206, 217-218, 232-233	571320	Z		201-202, 204-205, 224, 227, 233	571775	Z		205, 209, 214, 220-223, 235-236	572824	Z		204-205, 207, 214-215, 220-224, 227, 233-234, 236
570495	Z		200-204, 206, 209-210, 213-216, 218-224, 227, 231-233, 236	571325	Z		201-202, 204-206, 210-211, 215, 218, 222-225, 227, 232-233	571780	Z		205, 209, 214, 220-223, 235-236	572829	Z		205, 215, 218, 222-223, 225-226, 233-234
570620	Z		224	571327	Z		204, 206, 211, 218	571785	Z		205, 209, 214, 220-223, 235-236	572830	Z		204, 213
570650	Z		224	571330	Z		201-202, 204-206, 210-211, 215, 218, 222-225, 227, 232-233	571790	Z		205, 209, 214, 220-223, 235-236	572836	Z		227
570660	Z		224	571335	Z		201-202, 204-206, 210-211, 215, 222-225, 227, 232-233	571795	Z		205, 209, 214, 220-223, 235-236	572837	Z		204-205, 207, 209-210, 214-216, 218, 220, 222-224, 226-228, 232-234, 236
570670	Z		224	571337	Z		218, 224	571797	Z		223, 236	572839	Z		211, 225
570680	Z		224	571340	Z		201, 204, 206, 210-211, 215, 222-223, 225, 232-233	571855	Z		232	572840	Z		211, 225
570685	Z		234	571342	Z		218, 224	571865	Z		241	572841	Z		211, 225
570690	Z		224	571360	Z		221	571866	Z		184, 241	572844	Z		223, 228, 234-235
570717	Z		202, 205-206, 209, 211-212, 214, 217-219, 223, 226, 228, 234, 237	571370	Z		221	571870	Z		241	572845	Z		223, 228, 234-235
570720	Z		206, 209, 218, 223, 226	571375	Z		221	571871	Z		241	572846	Z		235
570727	Z		202, 205-206, 209, 211-212, 214, 217-219, 223, 226, 228, 234, 237	571380	Z		221	571887	Z		241	572847	Z		207
570730	Z		202, 205-206, 209, 211-212, 214, 217-219, 223, 226, 228, 234, 237	571432	Z		210	571889	Z		241	572850	Z		200, 206-208, 210-212, 219, 223-224, 228-231, 235-237
570735	Z		202, 206, 209, 211-212, 214, 217-219, 223, 226, 228, 237	571434	Z		210	571890	Z		241	572851	Z		200, 206-208, 210-212, 219, 223-224, 228-231, 235-237
570742	Z		204, 209, 213, 217-218, 228	571436	Z		210	571891	Z		184, 241	573008	Z		244
570747	Z		204, 209, 213, 217-218, 228	571438	Z		210	571895	Z		241	573018	E		244
570750	Z		202-205, 209, 211, 216-220, 223, 227-228, 232-234	571450	Z		203, 236-237	571896	Z		184, 241	573020	Z		247
570760	Z		200, 205, 210, 213, 216, 220, 222-223, 226-227	571455	Z		203, 236-237	571900	Z		215, 226, 237	573021	Z		247
570765	Z		200-220, 222-228, 232-234, 236-237	571460	Z		203, 236-237	571932	Z		210	573022	E		247
570770	Z		201-202, 204-207, 209-210, 213-214, 216, 218, 220, 222-224, 226-227, 232-233	571465	Z		203, 236-237	571934	Z		210	573023	E		247
570775	Z		200-228, 232-234, 236-237	571470	Z		203, 236-237	571980	Z		218	573100	Z		244
				571477	Z		203, 237	572101	Z		186	573102	Z		244
				571480	Z		213	572111	E		186	573106	Z		244
				571485	Z		213	572350	Z		236	573108	Z		244
				571545	Z		147	572355	Z		236	573110	Z		244
				571555	Z		147	572365	Z		204-205, 207, 209-211, 214-224, 226-228, 231-234, 236	573112	Z		249
				571560	Z		83, 147	572385	Z		204, 209, 213, 217-218, 228	573114	Z		249
				571565	Z		147	572400	Z		200, 202-206, 209-210, 213-218, 220-228, 232-234, 236-237	573116	Z		249
				571567	Z		109, 133, 149, 151, 191, 193, 195, 244, 247, 255, 285	572405	Z		200, 202-206, 209-210, 213-218, 220-228, 232-234, 236-237	573118	Z		249
				571571	Z		109, 111, 133, 149, 151, 191, 193, 195, 244, 247, 255, 285	572413	Z		223, 228, 234-235	573120	Z		249
				571574	Z		61, 87, 109, 111, 133, 141, 149, 151, 191, 193, 195, 197, 244, 247, 255, 285	572417	Z		214	573122	Z		249
				571578	Z		29, 51, 61, 67, 87, 141, 197	572420	Z		211, 218, 225, 233	573124	Z		249
				571581	Z		61, 87, 109, 111, 133, 141, 149, 151, 191, 193, 195, 197, 244,								

# List of articles

Art.-No.	RG	VE	Page	Art.-No.	RG	VE	Page	Art.-No.	RG	VE	Page	Art.-No.	RG	VE	Page
573325	Z		249	574754	Z		154, 177-178, 181, 200, 210, 230, 235	576015	E		195	578402	Z		169
573330	Z		249					576016	E		191	578404	Z		154-159, 161-162, 165-166, 168-169, 171-172, 174-175, 179-180
573335	Z		249	574756	Z		154-155, 160-164, 166, 169-172, 176-178, 181-182, 200-201, 207-208, 210-212, 214-215, 219, 221-224, 228-231, 235-237	576017	E		191				
573360	Z		249					576345	Z		191, 193, 195	578406	Z		154-159, 161-169, 171-172, 174-176, 178-180, 182-183
573364	Z		249					577000	Z		187				
573367	Z		249					577010	E		187	578408	Z		154, 156-159, 161, 165-169, 171-172, 179-180, 182
573370	Z		249	574758	Z		154-155, 160-164, 166, 169-172, 176-178, 181-182, 200-201, 207-208, 210-212, 214-215, 219, 221-224, 228-231, 235-237	577013	E		187				
573400	Z		249					578001	Z		147	578410	Z		155-169, 171-172, 174-176, 178-180, 183
573402	Z		249					578002	Z		149				
573404	Z		249					578003	Z		151	578412	Z		154-159, 161-169, 171-172, 174-176, 178-180, 182-183
573406	Z		249					578010	E		149				
573430	Z		244					578012	E		147	578420	Z		172
573432	Z		244					578013	E		147	578426	Z		172
573434	Z		244	574760	Z		154-155, 160-164, 166, 169-172, 176-178, 181-182, 200-201, 207-208, 210-212, 214-215, 219, 221-224, 228-231, 235-237	578014	E		149	578430	Z		172
573436	Z		244					578015	E		151	578432	Z		172
573438	Z		244					578016	E		151	578434	Z		175
573616	Z		249					578290	Z		147, 149, 151, 247, 255	578436	Z		175
573624	Z		249					578295	Z		183-184	578438	Z		175
573628	Z		249					578299	Z		147, 149, 151	578440	Z		175
573630	Z		249	574762	Z		154-155, 160-164, 166, 169-172, 176-178, 181-182, 200-201, 207-208, 210-212, 214-215, 219, 221-224, 228-231, 235-237	578310	Z		154-155, 160, 162, 164-165, 168, 170, 177-178, 181	578442	Z		175
573632	Z		249									578444	Z		165
573634	Z		249					578312	Z		154-157, 159-170, 172-179, 181-182	578446	Z		165
573636	Z		249									578448	Z		165
573638	Z		249					578314	Z		154-157, 159-170, 172-179, 181-182	578450	Z		165
573640	Z		249					578316	Z		154-157, 159-170, 172-179, 181-182	578452	Z		165
573642	Z		249	574764	Z		182					578454	Z		175
573644	Z		249	574766	Z		182	578318	Z		154-157, 159-170, 172-179, 181-182	578456	Z		156, 158-159, 161, 163-165, 167-169, 172, 174, 176, 180, 183
573646	Z		249	574768	Z		182					578458	Z		159, 161, 168, 172, 174
573647	Z		248	574770	Z		182	578324	Z		154-155, 160-164, 166, 169-172, 176-178, 181-182	578460	Z		156, 158-159, 161, 163-165, 167-169, 172, 174, 176, 180, 183
573648	Z		248	574772	Z		164, 166-168, 213, 215-216, 218								
573649	Z		248					578326	Z		154, 160, 162, 177-178	578462	Z		156, 158-159, 161, 163-165, 167-169, 172, 174, 176, 180, 183
573652	Z		249	574774	Z		168, 218, 234	578328	Z		154-155, 159-164, 166, 169-172, 176-178, 181-182				
574000	H		185	574776	Z		164, 167-168, 183, 213, 216, 218, 237	578330	Z		154, 160, 162, 177-178	578464	Z		156, 159, 161, 163-165, 167-169, 172, 174, 176, 180, 183
574300	H		245	574778	Z		154, 158, 161-162, 164, 166-171, 174-175, 179, 183, 200, 209-210, 213, 215-216, 218, 220, 222, 225-226, 228, 232-233	578332	Z		154-155, 159-164, 166, 169-172, 176-178, 181-182	578466	Z		157-158, 168, 174-175
574302	H		245									578468	Z		155-158, 161, 163, 165, 167-169, 172, 174-176, 180, 182
574352	Z		245					578334	Z		154-155, 159-164, 166, 169-172, 176-178, 181-182	578470	Z		157-158, 161, 165, 168, 172, 174-175
574430	Z		185	574782	Z		154-159, 161-176, 178-183, 200-206, 208-228, 231-234, 236-237					578472	Z		155-158, 161, 163, 165, 167-169, 172, 174-176, 180, 182
574436	Z		82-83, 185					578336	Z		154-155, 160-164, 166, 169-172, 176-178, 181-182	578474	Z		155-158, 161, 163, 165, 167-169, 172, 174-176, 180
574437	Z		245	574784	Z		161-162, 164, 167-169, 174, 183, 209-210, 213, 216, 218, 220, 225-226, 237					578476	Z		155-158, 161, 163, 165, 167-169, 172, 175-176, 180, 182
574516	Z		183, 238					578338	Z		154, 177-178, 181	578478	Z		161, 164, 167-168, 176
574700	Z		147, 149, 151, 183	574786	Z		155-159, 161-162, 164-166, 168-169, 171-175, 179-180, 183, 202, 204-206, 209-210, 213-214, 216, 218, 220, 222-226, 228, 232-233, 237				578480	Z		155-158, 161, 163, 165, 167-169, 172, 175-176, 180, 182	
574702	Z		185, 238					578340	Z		154, 177-178, 181	578482	Z		159, 164, 174, 181-183
574704	Z		183, 238					578342	Z		164, 166-168, 173	578484	Z		159, 164, 174, 181-183
574728	Z		156, 158-159, 161, 163-165, 167-169, 172, 174, 176, 180, 183, 202, 205-206, 209, 211-212, 214, 217-219, 223, 226, 228, 234, 237					578344	Z		158, 168, 181	578486	Z		181-182
574730	Z		156, 158-159, 161, 163-165, 167-169, 172, 174, 176, 180, 183, 202, 205-206, 209, 211-212, 214, 217-219, 223, 226, 228, 234, 237					578346	Z		164, 167-168, 183	578488	Z		159, 164, 174, 182-183
								578348	Z		154, 158, 161-162, 164, 166-171, 174-175, 178-180, 182-183	578490	Z		154-155, 157-159, 172, 175, 179-180
574732	Z		156, 158-159, 161, 163-165, 167-169, 172, 174, 176, 180, 183, 202, 205-206, 209, 211-212, 214, 217-219, 223, 226, 228, 234, 237									578492	Z		154-155, 157-159, 162-163, 166, 171-173, 175, 179-180
								578350	Z		161, 164, 168, 173	578494	Z		154-155, 157-159, 162-163, 166, 171-173, 175, 179-180
								578352	Z		154-159, 161-176, 178-183	578496	Z		154-155, 157-159, 162-163, 166, 171-173, 175, 179-180
574734	Z		156, 159, 161, 163-165, 167-169, 172, 174, 176, 180, 183, 202, 206, 209, 211-212, 214, 217-219, 223, 226, 228, 237									578498	Z		154, 157-159, 162-163, 166, 171-173, 179-180
								578354	Z		161-162, 164, 167-169, 174, 178, 183	578500	Z		177-178
												578502	Z		177-178
574736	Z		154-155, 160, 162, 164-165, 168, 170, 177-178, 181, 200-201, 207-209, 212-213, 217, 220, 229-231, 234					578356	Z		155-159, 161-162, 164-169, 171-175, 178-180, 183	578504	Z		166, 176-178
												578506	Z		177-178
574738	Z		154-157, 159-170, 172-179, 181-182, 200-204, 206-221, 224-232, 234, 237					578358	Z		154-159, 161-176, 178-183	578508	Z		166, 176-178
												578510	Z		166, 176-178
574740	Z		154-157, 159-170, 172-179, 181-182, 200-204, 206-221, 224-232, 234, 237					578360	Z		154-159, 161-176, 178-183	578512	Z		166, 176-178
												578514	Z		166, 176-178
574742	Z		154-157, 159-170, 172-179, 181-182, 200-204, 206-221, 224-232, 234, 237					578362	Z		154-176, 178-183	578516	Z		177-178
								578364	Z		154-159, 161-176, 178-183	578518	Z		166, 176-178
574744	Z		154-157, 159-170, 172-179, 181-182, 200-204, 206-221, 224-232, 234, 237									578520	Z		166, 176-178
								578366	Z		156, 158, 167-168, 179-180	578522	Z		166, 176-178
574746	Z		154-157, 159-170, 172-179, 181-182, 200-204, 206-221, 224-232, 234, 237									578524	Z		170
								578368	Z		154-155, 157-158, 161-163, 165-172, 174-176, 178-182	578526	Z		170
574748	Z		154-155, 160-164, 170-171, 177-178, 181-182, 200-201, 207-208, 210, 212, 221, 229-231, 235-236									578528	Z		170
								578370	Z		154, 158, 162, 164, 166, 170-172, 174-175	578530	Z		170
574750	Z		154, 177-178, 181, 200, 230, 235									578532	Z		156, 182-183
								578372	Z		154-176, 178-183	578534	Z		156, 182-183
574752	Z		154-155, 160-164, 166, 169-172, 176-178, 181-182, 200-201, 207-208, 210-212, 214-215, 219, 221-224, 228-231, 235-237									578536	Z		156, 182-183
								578374	Z		154-162, 164-166, 168, 170-172, 174-175, 179-180	578538	Z		156, 182-183
												578540	Z		156, 182-183
								578376	Z		154-176, 178-183	578542	Z		181
												578544	Z		154, 181-182
								578378	Z		154-176, 178-183	578546	Z		158, 161, 166, 169-172, 182
								578380	Z		154, 156-157, 159-175, 178-183	578548	Z		158, 161, 166, 169-172, 182
								578382	Z		154-176, 178-183				
								578384	Z		154-155, 157-158, 161-163, 165-172, 174-176, 178-18				

# List of articles

Art.-No.	RG	VE	Page	Art.-No.	RG	VE	Page	Art.-No.	RG	VE	Page	Art.-No.	RG	VE	Page
578570	Z		158, 161, 166, 169–172, 182	580010	E		137	590056	Z		135	751568	S		44
578572	Z		174	580014	E		141	590057	Z		135	751569	S		44
578576	Z		180	580020	E		137	590058	Z		135	751570	S		44
578578	Z		180, 182	580021	E		137	590059	Z		135	751571	S		44
578582	Z		180, 182	580022	E		137	590060	Z		135	753240	Z		43
578584	Z		180, 182	580023	E		137	590061	Z		135	759250	S		44
578586	Z		180, 182	580024	E		137	590062	Z		135	759251	S		44
578588	Z		168, 173	580025	E		137	590111	Z		135	759252	S		44
578590	Z		168, 173	580026	E		137	590150	Z		135	759253	S		44
578592	Z		163, 168, 173, 180	580027	E		137	590153	Z		135	759254	S		44
578594	Z		163, 168, 173, 180	580028	E		137	590160	Z		135, 139	759255	S		44
578596	Z		163, 168, 173, 180	580029	E		137	731200	Z		31	759256	S		44
578598	Z		163, 168, 173, 180	580030	E		137	731205	Z		31	759257	S		44
578600	Z		163, 168, 173, 180	580031	E		137	731210	Z		31	759258	S		44
578602	Z		180	580033	E		137	731220	Z		31	759259	S		44
578604	Z		154–155, 160–164, 166, 169–172, 176–178, 181–182	580034	E		137	731230	Z		31	759260	S		44
578606	Z		158, 161, 166, 169–172, 182	580035	E		137	731240	Z		31	759261	S		44
578608	Z		154	580036	E		137	731250	Z		31	759262	S		44
578610	Z		154	580037	E		137	731301	Z		31	759263	S		44
578612	Z		154, 158	580038	E		137	731302	Z		31	759264	S		44
578614	Z		154	580039	E		137	731303	Z		31	759265	S		44
578618	Z		179	580040	E		137	731304	Z		31	759270	S		44
578620	Z		184	580051	E		141	731305	Z		31	759271	S		44
578621	Z		184	580052	E		141	731306	Z		31	759272	S		44
578622	Z		184	580053	E		141	731307	Z		31	759273	S		44
578624	Z		154–158, 161–162, 164–176, 178–183	580054	E		141	731308	Z		31	759274	S		44
578630	Z		162–163, 170, 173, 182	580055	E		141	731309	Z		31	759275	S		44
578632	Z		162–163, 170, 173, 182	580056	E		141	731310	Z		31	759276	S		44
578634	Z		162–163, 170, 173, 182	580057	E		141	731311	Z		31	759277	S		44
578636	Z		163, 170, 173, 182	580058	E		141	731312	Z		31	759278	S		44
578638	Z		157–159, 163	580059	E		141	731320	Z		31	759279	S		44
578640	Z		172, 182	580060	E		141	731321	Z		31	759280	S		44
578642	Z		172, 182	580061	E		141	731322	Z		31	759281	S		44
578644	Z		172, 182	580062	E		141	731323	Z		31	759282	S		44
578646	Z		172, 182	580063	E		141	731324	Z		31	759330	S		44
578652	Z		175	580064	E		141	731325	Z		31	759360	S		44
578654	Z		175	580065	E		141	731326	Z		31	759361	S		44
578656	Z		175	580066	E		141	731700	Z		24–27, 29, 97	759362	S		44
578659	Z		183	580067	E		141	750003	U		43	759363	S		44
578660	Z		172, 181	580068	E		141	750004	U		43	759364	S		44
578664	Z		172, 176, 181	580069	E		141	751000	Z		43	759365	S		44
578666	Z		172, 176, 181	580100	Z		139	751040	Z		43	759366	S		44
578670	Z		164	580110	E		139	751050	Z		43	759367	S		44
578700	Z		159	581070	Z		143	751060	Z		43	759368	S		44
578702	Z		159	581080	Z		143	751070	Z		43	759370	S		44
578704	Z		159	581110	Z		143	751080	Z		43	759371	S		44
578706	Z		159	581130	Z		143	751090	Z		43	759372	S		44
578708	Z		159	581150	Z		143	751096	Z		43	759373	S		44
578710	Z		159	581180	Z		143	751097	Z		43	759374	S		44
578712	Z		159	581200	Z		143	751098	Z		43	759375	S		44
578714	Z		159	581210	Z		143	751100	Z		43	759376	S		44
578716	Z		168	581220	Z		143	751102	Z		43	759377	S		44
578718	Z		168	581230	Z		143	751501	S		44	759378	S		44
578720	Z		168	581240	Z		143	751502	S		44	759379	S		44
578740	Z		173, 183	581260	Z		143	751503	S		44	759380	S		44
578742	Z		173, 183	581270	Z		143	751504	S		44	759381	S		44
578744	Z		173, 183	581280	Z		143	751505	S		44	759382	S		44
578746	Z		173, 183	581310	Z		143	751506	S		44	759383	S		44
579000	Z		188	581320	Z		143	751507	S		44	759384	S		44
579001	Z		197	581330	Z		143	751508	S		44	844010	E		82
579010	E		188	581350	Z		143	751509	S		44	844011	E		83
579012	E		188	581360	Z		143	751510	S		44	844045	Z		82–83
579014	E		197	581370	Z		143	751511	S		44	844050	Z		82–83
579100	Z		200, 207, 228, 230	581380	Z		143	751516	S		44	844051	Z		82–83
579101	Z		200–204, 207–213, 215–221, 224–232, 234, 237	581390	Z		143	751517	S		44	844510	Z		83
579104	Z		210	581400	Z		143	751518	S		44	845001	M		85
579105	Z		210	581410	Z		143	751519	S		44	845002	M		87
579106	Z		210	581420	Z		143	751520	S		44	845003	M		85
579107	Z		212–213, 230–231	581430	Z		143	751521	S		44	845004	M		89
579108	Z		200, 207, 220, 230–231	581440	Z		143	751522	S		44	845050	Z		85, 87, 89
579109	Z		200	581450	Z		143	751523	S		44	845051	Z		85, 87, 89
579110	Z		200–204, 207–213, 215–221, 224–232, 234, 237	581460	Z		143	751524	S		44	845052	Z		85, 87, 89
579111	Z		200–204, 207–213, 215–221, 224–232, 234, 237	581470	Z		143	751525	S		44	845053	Z		85, 87, 89
579112	Z		235	581480	Z		143	751526	S		44	845054	Z		85
579113	Z		235	581490	Z		143	751527	S		44	845055	Z		85, 87, 89
579114	Z		235	581500	Z		143	751528	S		44	845057	Z		89
579120	Z		188, 238	581510	Z		143	751544	S		44	845060	Z		89
579123	Z		197, 238	581520	Z		143	751545	S		44	845085	Z		85
579144	Z		207	581530	Z		143	751546	S		44	845110	Z		85, 87
579146	Z		207	581540	Z		143	751547	S		44	845118	Z		85, 87
579240	Z		188	582036	Z		137, 139, 141–142	751548	S		44	845131	Z		85
579600	Z		119, 123	582110	Z		139	751549	S		44	845218	Z		85, 87
579601	Z		188, 197	582120	Z		139	751550	S		44	845220	Z		85, 87, 89
579603	Z		238	586000	Z		137	751551	S		44	845230	Z		89
580000	Z		137, 142	586012	Z		139	751552	S		44	845530	Z		85, 87
580004	Z		141	586100	Z		137, 141	751557	S		44	849006	M		70
				586150	Z		137, 141	751558	S		44	849007	M		71
				590000	Z		135	751559	S		44	849310	Z		49, 51, 70–71, 85, 87
				590020	E		135	751560	S		44	849315	Z		49, 51, 70–71, 85, 87
				590021	E		135	751561	S		44	849700	Z		71
				590022	E		135	751562	S		44	849703	Z		70–71
				590051	Z		135	751563	S		44	849706	Z		70–71
				590052	Z		135	751564	S		44				
				590053	Z		135	751565	S		44				
				590054	Z		135	751566	S		44				
				590055	Z		135	751567	S		44				

# Notes

---



# REMS

[www.rems.de](http://www.rems.de)

## Head Office

 **Germany:** REMS GmbH & Co KG  
Postfach 1631 · 71306 Waiblingen · Germany  
Stuttgarter Straße 83 · 71332 Waiblingen · Germany  
Tel +49 7151 17 07-0  
[info@rems.de](mailto:info@rems.de)

## Branch Offices

 **Denmark:** REMS Scandinavia A/S  
Snedkervej 1 · 4600 Køge · Denmark  
Tel +45 56 63 14 00  
[DNK@rems.de](mailto:DNK@rems.de)

 **France:** REMS SARL  
2, Rue du Stade · 67250 Hoffen · France  
Tel +33 388 80 44 53  
[FRA@rems.de](mailto:FRA@rems.de)

 **Great Britain:** REMS (U.K.) LIMITED  
Unit 5 · Ash Industrial Estate  
Flex Meadow · Harlow · Essex CM19 5TJ · U.K.  
Tel +44 1279 413698  
[GBR@rems.de](mailto:GBR@rems.de)

 **Italy:** REMS S.R.L.  
Via Sirtori, 13/D · 20017 Passirana di Rho (Milano) · Italy  
Tel +39 02 9 30 21 11  
[ITA@rems.de](mailto:ITA@rems.de)

 **Poland:** REMS POLSKA Sp. z o.o.  
Dąbrowa · Ulica Piaskowa 19 · 62-070 Dopiewo · Poland  
Tel +48 61 654 09 00  
[POL@rems.de](mailto:POL@rems.de)

 **Spain:** REMS ESPAÑA, S.A.U.  
Pol. Ind. San José de Valderas  
Calle Herramientas, 28 · 28918 Leganés (Madrid) · Spain  
Tel +34 916 444 833  
[ESP@rems.de](mailto:ESP@rems.de)

 **Czech Republic:** REMS Česká republika s.r.o.  
Nádražní 271 · 253 01 Hostivice · Czech Republic  
Tel +420 2 20 98 28 80  
[CZE@rems.de](mailto:CZE@rems.de)

**Prodaja preko pooblaščenih trgovin.**



Cesta na Brdo 85, 1000 Ljubljana  
tel:+386 1 256 10 56, fax:+386 1 256 10 55  
mailto:[info@energe.si](mailto:info@energe.si), <http://www.energe.si>